

## High surge voltage 1.25 A SCR for circuit breaker

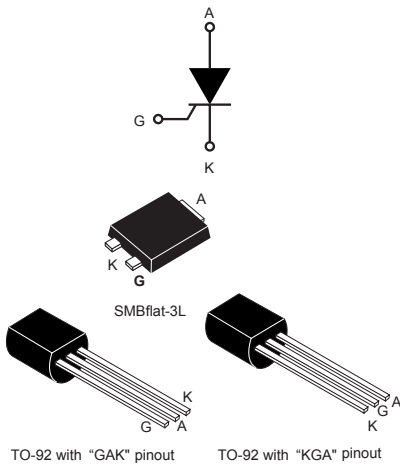

### Features

- On-state rms current,  $I_{T(RMS)}$  1.25 A
- Repetitive peak off-state voltage,  $V_{DRM}/V_{RRM}$ , 800 V
- Non-repetitive direct surge peak off-state voltage, 1250 V
- Non-repetitive reverse surge peak off-state voltage, 900 V
- Triggering gate current,  $I_{GT(Q1)}$  100  $\mu$ A
- High off-state immunity: 200 V/ $\mu$ s
- ECOPACK2 compliant component

### Applications

- GFCI (ground fault circuit interrupters)
- AFCI (arc fault circuit interrupters)
- RCD (residual current device)
- RCBO (residual current circuit breaker with overload protection)
- AFDD (arc fault detection device)

#### Product status link

[TS110-8](#)

#### Product summary

$I_{T(RMS)}$	1.25 A
$V_{DRM} / V_{RRM}$	800 V
$V_{DSM} / V_{RSM}$	1250 V, 900 V
$I_{GT}$ standard	100 $\mu$ A
$T_j$	125 °C

### Description

Thanks to highly sensitive triggering levels, the TS110-8 series is suitable for circuit breaker applications where the available gate current is limited.

The 1250 V direct surge voltage capability of the TS110-8 enables high robustness of the whole circuit breaker. The low leakage current of the TS110-8 reduces power consumption over the entire lifetime of the circuit breaker. The high off-state immunity (200 V/ $\mu$ s) insures the non tripping of the breaker in case of electrical fast transient (EFT) on the mains.

The TS110-8 is available in through-hole TO-92 package with GAK and KGA pinout and in SMBflat-3L.

# 1 Characteristics

**Table 1. Absolute ratings (limiting values,  $T_J = 25\text{ °C}$  unless otherwise specified)**

Symbol	Parameters	Value	Unit		
$I_{T(RMS)}$	RMS on-state current (180 ° conduction angle)	TO-92 $T_L = 53\text{ °C}$	1.25	A	
		SMBflat-3L $T_{tab} = 109\text{ °C}$			
$I_{T(AV)}$	Average on-state current (180 ° conduction angle)	TO-92 $T_L = 53\text{ °C}$	0.8	A	
		SMBflat-3L $T_{tab} = 109\text{ °C}$			
$I_{TSM}$	Non repetitive surge peak on-state current	$t_p = 8.3\text{ ms}$	$T_{j\text{ initial}} = 25\text{ °C}$	21	
		$t_p = 10\text{ ms}$		20	
	1st step: one surge every 5 seconds, 25 surges	$t_p = 10\text{ ms}$	$T_{amb} = 90\text{ °C}$	25 times 12 A	
	2nd step: one surge every 5 seconds, 25 surges			25 times 16 A	
$I^2t$	$I^2t$ value for fusing	$t_p = 10\text{ ms}$	$T_j = 25\text{ °C}$	2	$A^2s$
$di/dt$	Critical rate of rise of on-state current	F = 50 Hz	$T_j = 125\text{ °C}$	100	$A/\mu s$
	$I_G = 2 \times I_{GT}$ , $t_r \leq 100\text{ ns}$				
	Non repetitive critical current rate of rise at break-over, see Figure 17, $V_D > V_{DSM}$			200	
$V_{DRM}$ , $V_{RRM}$	Repetitive peak off-state AC voltage, $R_{GK} = 220\ \Omega$		$T_j = 125\text{ °C}$	800	V
$V_{DSM}$	Non-repetitive direct surge peak off-state voltage, $R_{GK} = 220\ \Omega$	$t_p = 10\text{ ms}$	$T_j = 25\text{ °C}$	1250	V
$V_{RSM}$	Non-repetitive reverse surge peak off-state voltage, $R_{GK} = 220\ \Omega$	$t_p = 10\text{ ms}$	$T_j = 25\text{ °C}$	900	V
$I_{GM}$	Peak gate current	$t_p = 20\ \mu s$	$T_j = 125\text{ °C}$	1.2	A
$P_{G(AV)}$	Average gate power dissipation		$T_j = 125\text{ °C}$	0.2	W
$T_{stg}$	Storage junction temperature range			-40 to +150	$^{\circ}C$
$T_j$	Operating junction temperature range			-40 to +125	$^{\circ}C$

**Table 2. Electrical characteristics ( $T_j = 25\text{ °C}$ , unless otherwise specified)**

Symbol	Parameters	Value	Unit	
$I_{GT}^{(1)}$	$V_D = 12\text{ V}$ , $R_L = 140\ \Omega$	$T_j = 25\text{ °C}$	Min. 1	$\mu A$
			Max. 100	
$V_{GT}$		$T_j = 125\text{ °C}$	Max. 0.8	V
$V_{GD}$	$V_D = V_{DRM}$ , $R_L = 33\text{ k}\Omega$ , $R_{GK} = 220\ \Omega$	$T_j = 125\text{ °C}$	Min. 0.1	V
$V_{RG}$	$I_{RG} = 2\text{ mA}$	$T_j = 25\text{ °C}$	Min. 7.5	V
$I_H^{(2)}$	$I_T = 50\text{ mA}$ , $R_{GK} = 220\ \Omega$	$T_j = 25\text{ °C}$	Max. 12	mA
$I_L$	$I_G = 5\text{ mA}$ , $R_{GK} = 220\ \Omega$	$T_j = 25\text{ °C}$	Max. 12	mA
$dV/dt^{(2)}$	$V_D = 67\% V_{DRM}$ , $R_{GK} = 220\ \Omega$	$T_j = 125\text{ °C}$	Min. 200	$V/\mu s$

1. Minimum  $I_{GT}$  is guaranteed at 5% of  $I_{GT}$  max.
2. For both polarities of A2 referenced to A1

**Table 3. Static electrical characteristics**

Symbol	Test conditions			Value	Unit
$V_{TM}^{(1)}$	$I_{TM} = 2.5 \text{ A}$ , $t_p = 380 \text{ } \mu\text{s}$	$T_j = 25 \text{ }^\circ\text{C}$	Max.	1.6	V
$V_{TO}^{(1)}$	Threshold on-state voltage	$T_j = 125 \text{ }^\circ\text{C}$	Max.	0.95	V
$R_d$	Dynamic resistance	$T_j = 125 \text{ }^\circ\text{C}$	Max.	220	m $\Omega$
$I_{DRM}, I_{RRM}$	$V_{DRM} = V_{RRM}$ , $R_{GK} = 220 \text{ } \Omega$	$T_j = 25 \text{ }^\circ\text{C}$	Max.	1	$\mu\text{A}$
		$T_j = 125 \text{ }^\circ\text{C}$		100	$\mu\text{A}$

1. For both polarities of A2 referenced to A1

**Table 4. Thermal resistance**

Symbol	Parameters		Max. value	Unit
$R_{th(j-l)}$	Junction to lead (DC)	TO-92	65	$^\circ\text{C/W}$
$R_{th(j-a)}$	Junction to ambient (DC)	TO-92	160	
		SMBflat-3L	75	
$R_{th(j-c)}$	Junction to case ( $S^{(1)} = 5 \text{ cm}^2$ )	SMBflat-3L	14	

1. Copper surface under tab.

## 1.1 Characteristics (curves)

**Figure 1. Maximum average power dissipation versus average on-state current**

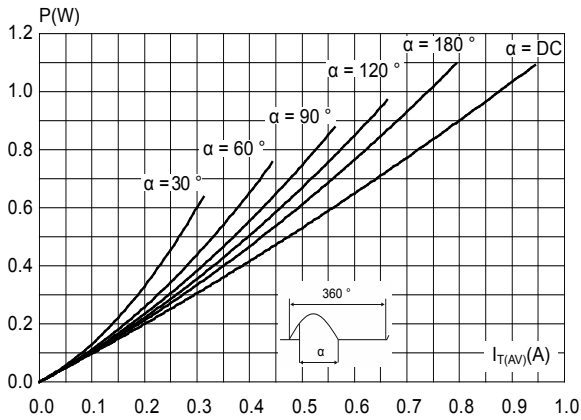

**Figure 2. Average and DC on-state current versus lead temperature (TO-92)**

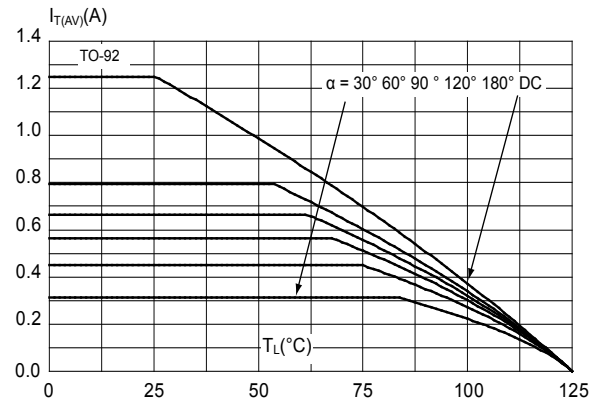

**Figure 3. Average and DC on-state current versus case temperature (SMBflat-3L)**

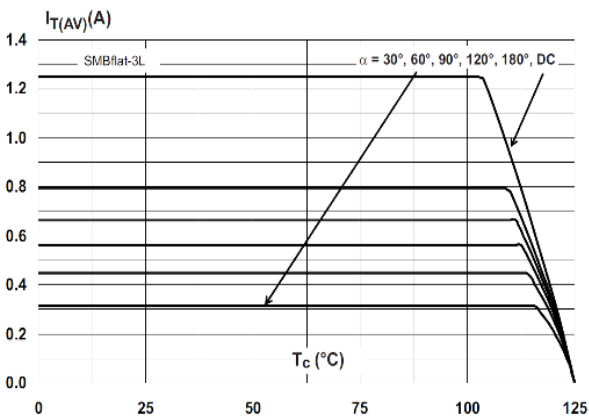

**Figure 4. Average and DC on-state current versus ambient temperature**

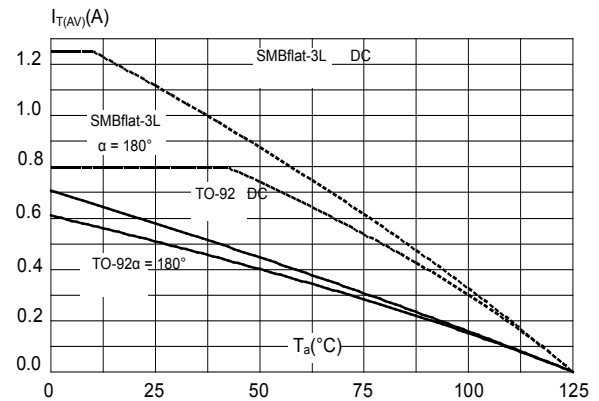

**Figure 5. Relative variation of thermal impedance junction to ambient versus pulse duration**

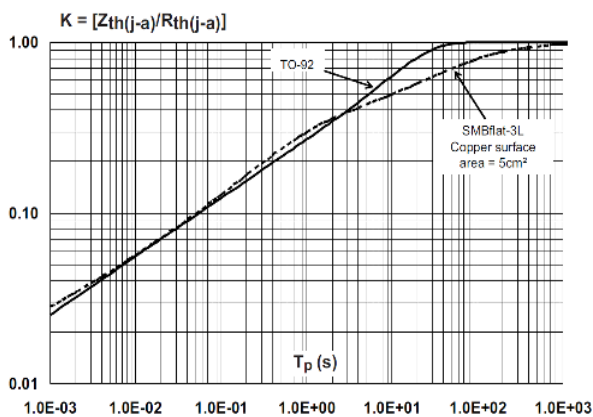

**Figure 6. Relative variation of gate trigger current and trigger voltage versus junction temperature (typical values)**

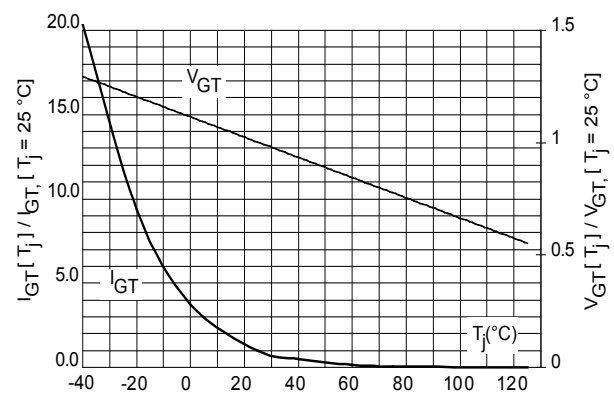

**Figure 7. Relative variation of latching and holding current versus junction temperature (typical values)**

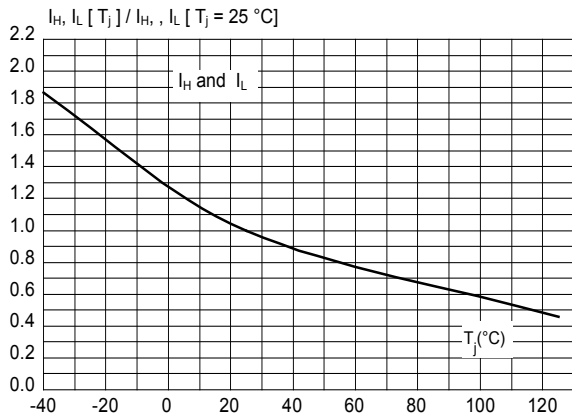

**Figure 8. Relative variation of holding current versus gate-cathode resistance (typical values)**

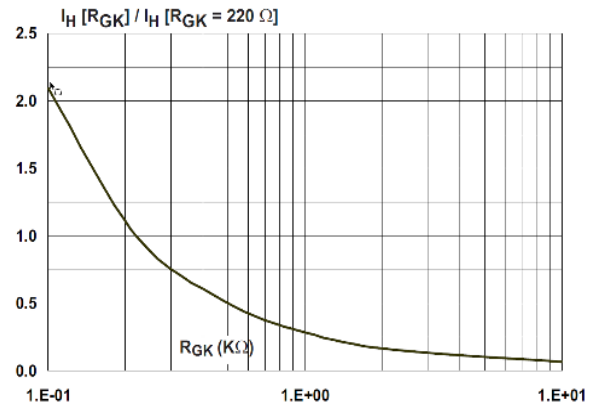

**Figure 9. Relative variation of dV/dt immunity versus junction temperature (typical values)**

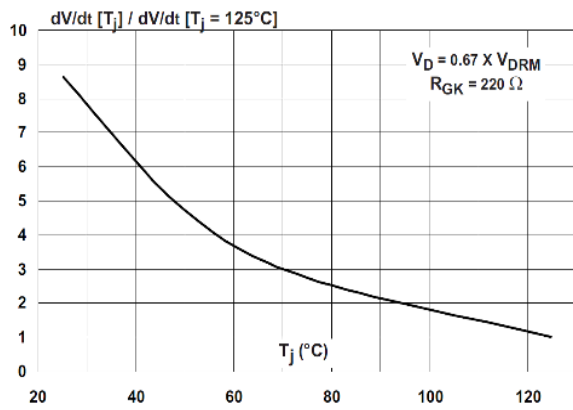

**Figure 10. Relative variation of dV/dt immunity versus gate-cathode resistance (typical values)**

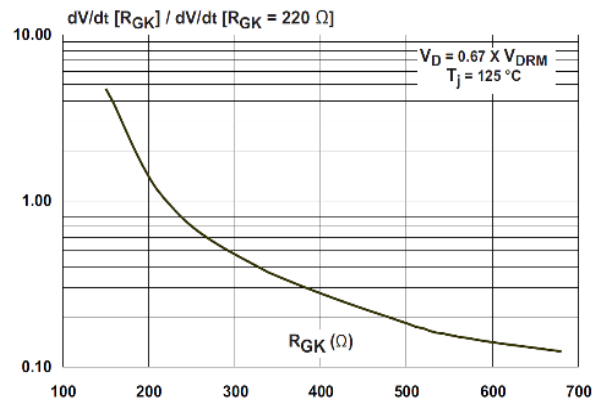

**Figure 11. Relative variation of dV/dt immunity versus gate-cathode capacitor (typical values)**

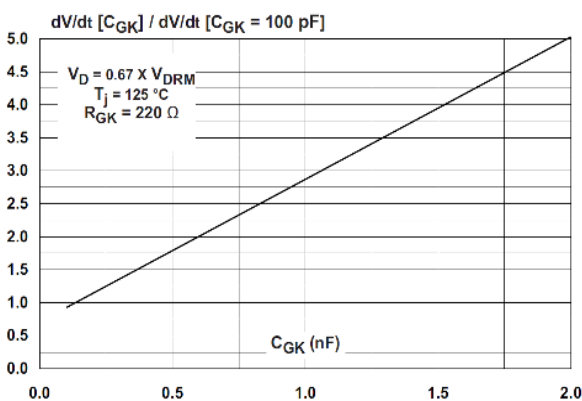

**Figure 12. On-state characteristics (maximum values)**

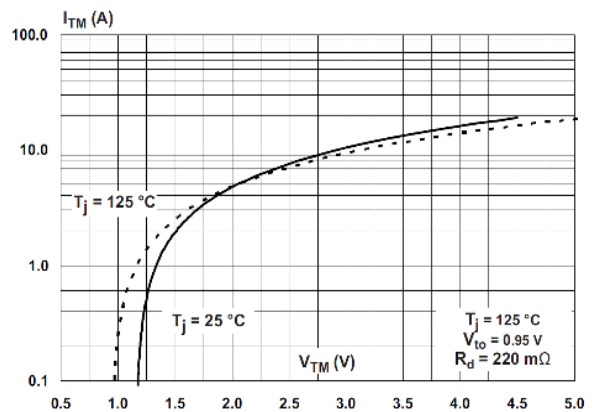

Figure 13. Surge peak on-state current versus number of cycles

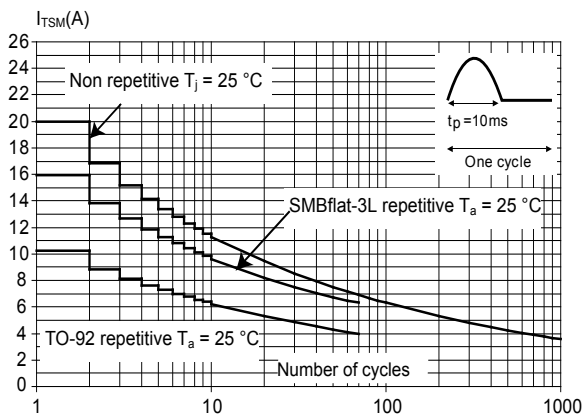

Figure 14. Non-repetitive surge peak on-state current

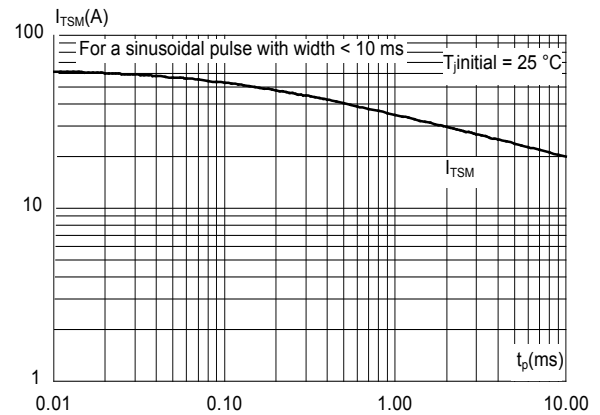
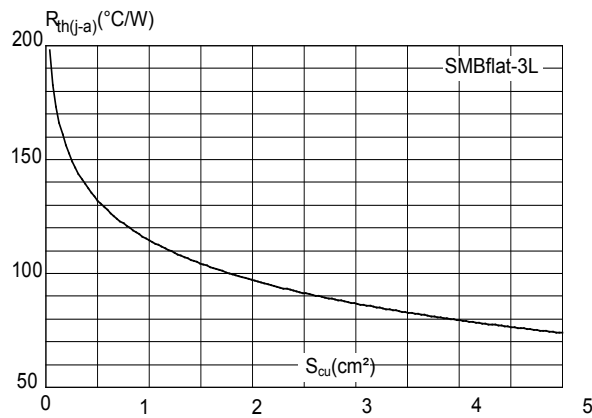

Figure 15. Thermal resistance junction to ambient versus copper surface under anode (epoxy FR4,  $Cu_{th} = 35\text{ }\mu\text{m}$ )



## 2 AC line transient voltage ruggedness

In comparison with standard SCRs, the TS110-8 is self-protected against over-voltage. The TS110-8 switch can safely withstand AC line surge voltages by switching to the on state (for less than 10 ms on 50 Hz mains) to dissipate energy shocks through the load. The load limits the current through the TS110-8. The self-protection against over-voltage is based on an overvoltage crowbar technology. This safety feature works even with high turn-on current ramp up.

The Figure 16 represents the TS110-8 in a test environment. It is used to stress the TS110-8 switch according to the IEC 61000-4-5 standard conditions. The TS110-8 folds back safely to the on state as shown in the Figure 17. The TS110-8 recovers its blocking voltage capability after the surge and the next zero current crossing. Such a non repetitive test can be done at least 10 times.

**Figure 16. Overvoltage ruggedness test circuit for IEC 61000-4-5 standards**

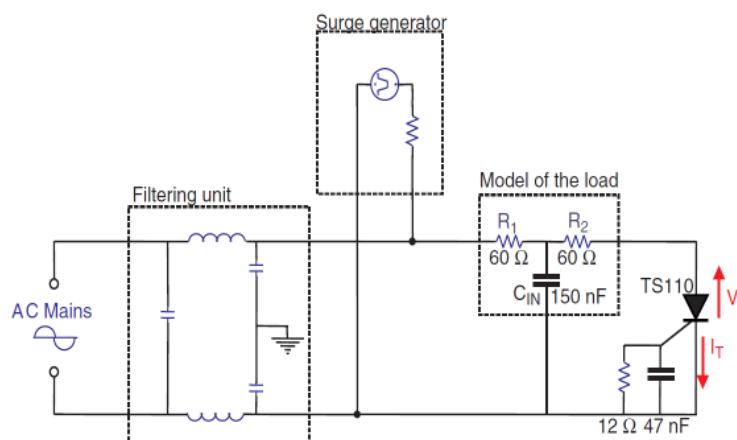

**Figure 17. Typical current and voltage waveforms across the TS110-8 during IEC 61000-4-5 standard test**

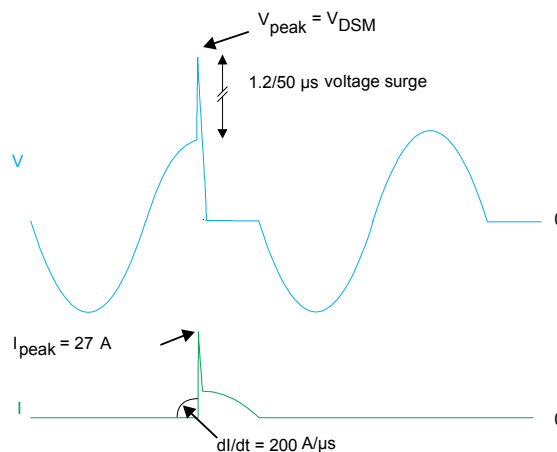

### 3 Package information

In order to meet environmental requirements, ST offers these devices in different grades of **ECOPACK** packages, depending on their level of environmental compliance. ECOPACK specifications, grade definitions and product status are available at: [www.st.com](http://www.st.com). ECOPACK is an ST trademark.

#### 3.1 TO-92 package information

- Lead free plating + halogen-free molding resin
- Epoxy meets UL94, V0

**Figure 18. TO-92 package outline**

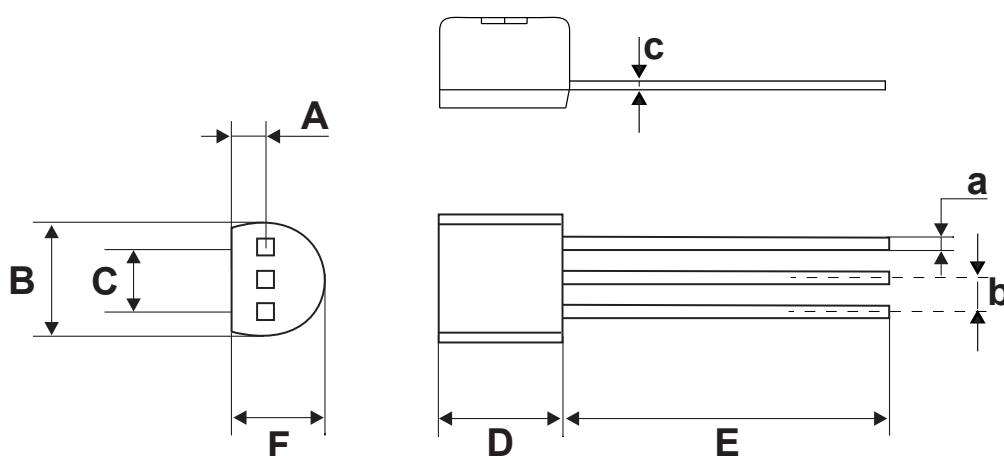

**Table 5. TO-92 package mechanical data**

Ref.	Dimensions					
	Millimeters			Inches <sup>(1)</sup>		
	Min.	Typ.	Max.	Min.	Typ.	Max.
A		1.35			0.0531	
B			4.70			0.1850
C		2.54			0.1000	
D	4.40			0.1732		
E	12.70			0.5000		
F			3.70			0.1457
a			0.50			0.0197
b		1.27			0.0500	
c			0.48			0.0189

1. Inches dimensions given for information



### 3.2 SMBflat-3L package information

- Epoxy meets UL94, V0
- Lead-free package

Figure 19. SMBflat-3L package outline

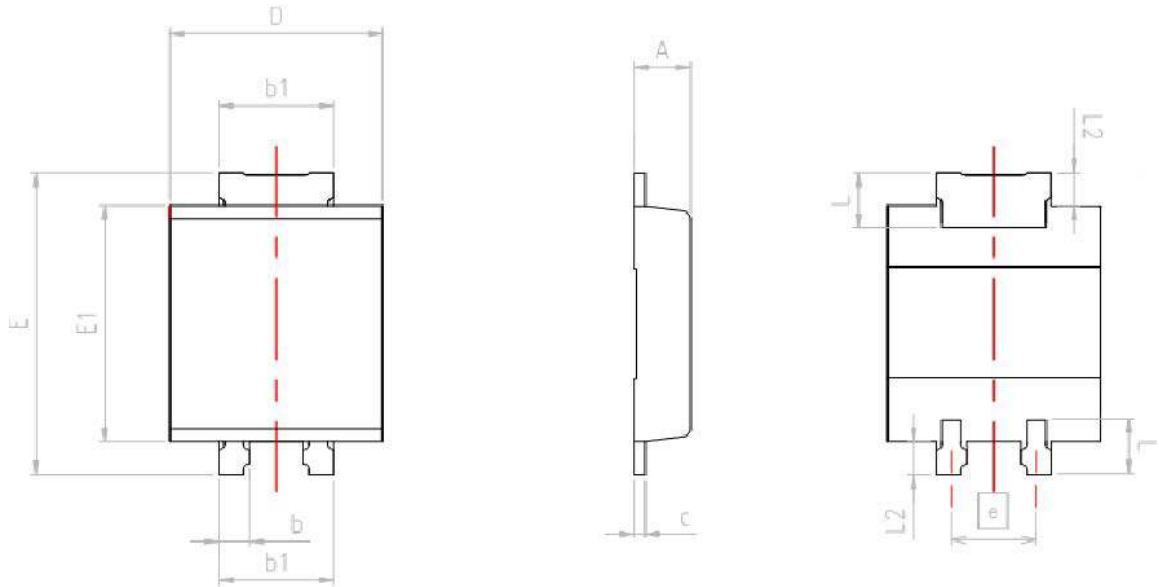

Note: This package drawing may slightly differ from the physical package. However, all the specified dimensions in the following table are guaranteed.

Table 6. SMBflat-3L mechanical data

Ref.	Dimensions					
	Millimeters			Inches (dimensions are for reference only)		
	Min.	Typ.	Max.	Min.	Typ.	Max.
A	0.90		1.10	0.0354		0.0433
b	0.35		0.65	0.0138		0.0256
b1	1.95		2.20	0.0768		0.0866
c	0.15		0.40	0.0059		0.0157
D	3.30		3.95	0.1299		0.1555
E	5.10		5.60	0.2008		0.2205
E1	4.05		4.60	0.1594		0.1811
L	0.75		1.50	0.0295		0.0591
L2		0.60			0.0236	
e		1.60			0.0630	

Figure 20. Footprint recommendations, dimensions in mm (inches)

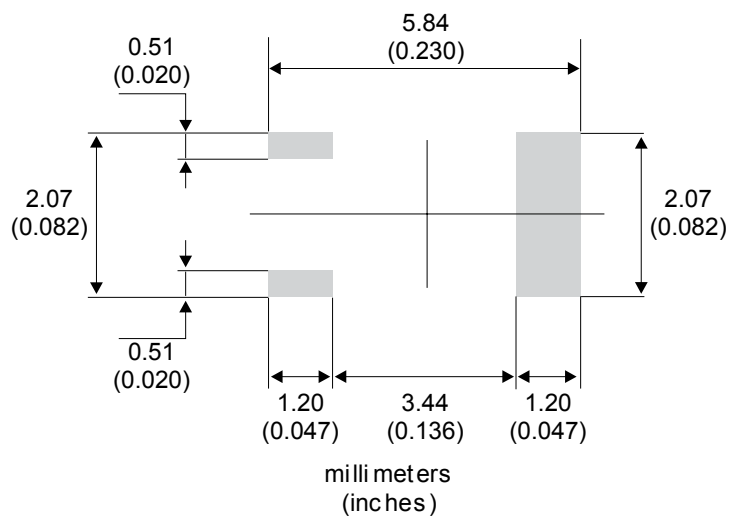

Note: This drawing may not be in scale; however, all the specified dimensions are guaranteed.

## 4 Ordering information

**Figure 21. Ordering information scheme**

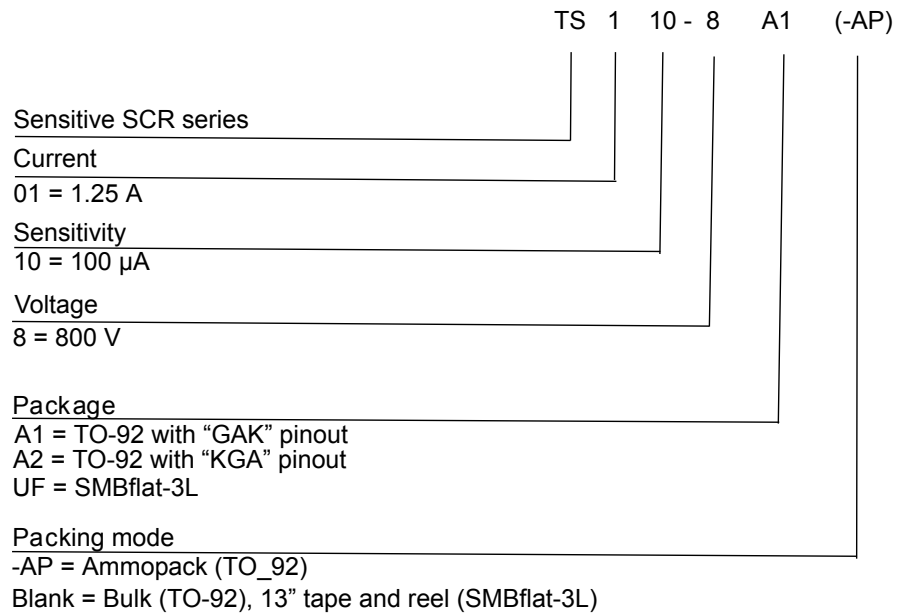

**Table 7. Ordering information**

Order code	Marking	Package	Weight	Base qty.	Delivery mode
TS110-8A1	TS110-8	TO-92	200 mg	2500	Bulk
TS110-8A1-AP				2000	Ammopack
TS110-8A2				2500	Bulk
TS110-8A1-APTS110-8A2-AP				2000	Ammopack
TS110-8UF		SMBflat-3L	47 mg	5000	Tape and reel 13"

## Revision history

**Table 8. Document revision history**

Date	Revision	Changes
13-Oct-2014	1	Initial release.
11-May-2023	2	Updated <a href="#">Figure 19</a> and <a href="#">Table 6</a> . Minor text changes.

**IMPORTANT NOTICE – READ CAREFULLY**

STMicroelectronics NV and its subsidiaries (“ST”) reserve the right to make changes, corrections, enhancements, modifications, and improvements to ST products and/or to this document at any time without notice. Purchasers should obtain the latest relevant information on ST products before placing orders. ST products are sold pursuant to ST’s terms and conditions of sale in place at the time of order acknowledgment.

Purchasers are solely responsible for the choice, selection, and use of ST products and ST assumes no liability for application assistance or the design of purchasers’ products.

No license, express or implied, to any intellectual property right is granted by ST herein.

Resale of ST products with provisions different from the information set forth herein shall void any warranty granted by ST for such product.

ST and the ST logo are trademarks of ST. For additional information about ST trademarks, refer to [www.st.com/trademarks](http://www.st.com/trademarks). All other product or service names are the property of their respective owners.

Information in this document supersedes and replaces information previously supplied in any prior versions of this document.

© 2023 STMicroelectronics – All rights reserved