

HEIDI-M-NP

~25° medium beam. Version without location pins.

SPECIFICATION:

Dimensions	Ø 21.6 mm
Height	11.6 mm
Fastening	tape
ROHS compliant	yes ⓘ

MATERIALS:

Component	Type	Material	Colour	Finish
HEIDI-M-NP	Single lens	PMMA	clear	
HEIDI-TAPE	Tape	Acrylic foam	black	

ORDERING INFORMATION:

Component	Type	Qty in box	MOQ	MPQ	Box weight (kg)
CA14000_HEIDI-M-NP	Single lens	3264	204	204	10.8
» Box size: 480 x 280 x 300 mm					



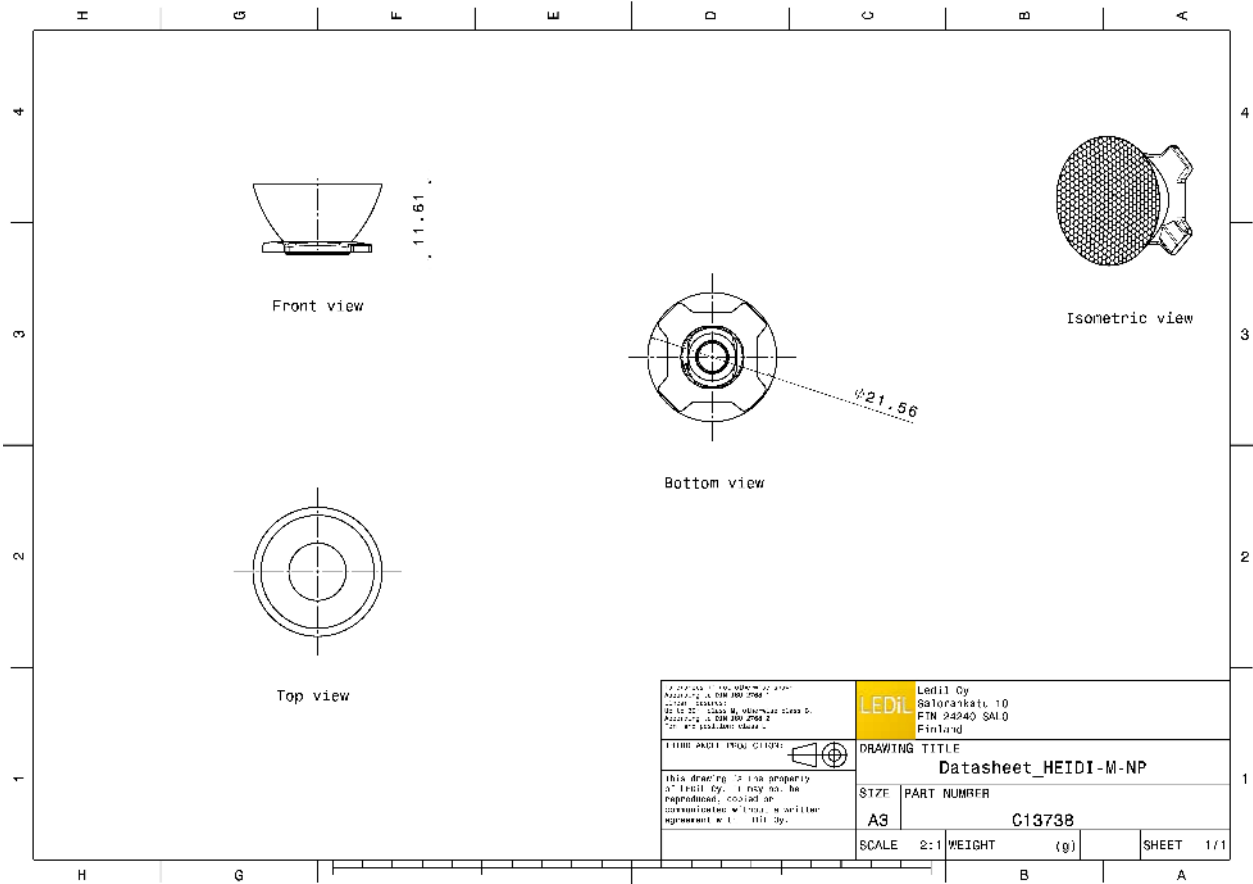

See also our general installation guide: www.ledil.com/installation_guide

OPTICAL RESULTS (MEASURED):

SAMSUNG

LED LH351B
FWHM / FWTM 29.0° / 51.0°
Efficiency 88 %
Peak intensity 3.1 cd/lm
LEDs/each optic 1
Light colour White
Required components:

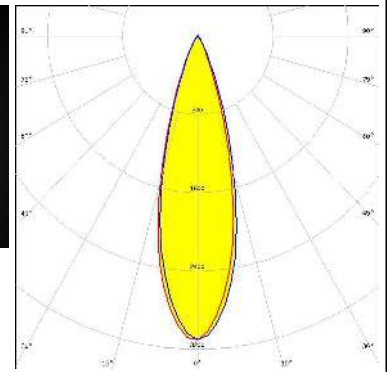
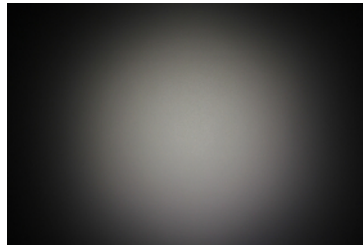

SAMSUNG

LED LH351Z
FWHM / FWTM 30.0° / 50.0°
Efficiency 89 %
Peak intensity 3.3 cd/lm
LEDs/each optic 1
Light colour White
Required components:

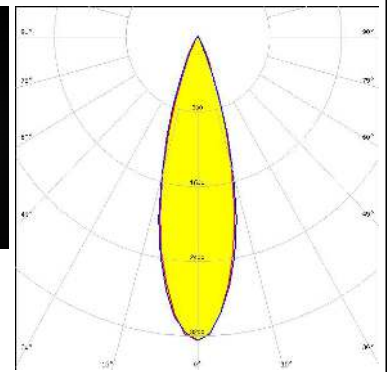
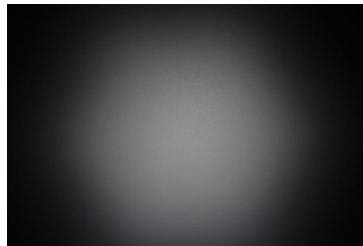

OPTICAL RESULTS (SIMULATED):

CREE LED

LED	ML-E
FWHM / FWTM	28.0° / 49.0°
Efficiency	92 %
Peak intensity	3.5 cd/lm
LEDs/each optic	1
Light colour	White
Required components:	

CREE LED

LED	XB-D
FWHM / FWTM	28.0° / 46.0°
Efficiency	89 %
Peak intensity	3.6 cd/lm
LEDs/each optic	1
Light colour	White
Required components:	

CREE LED

LED	XP-E
FWHM / FWTM	28.0° / 45.0°
Efficiency	93 %
Peak intensity	4 cd/lm
LEDs/each optic	1
Light colour	White
Required components:	

CREE LED

LED	XP-E2
FWHM / FWTM	29.0° / 46.0°
Efficiency	93 %
Peak intensity	3.8 cd/lm
LEDs/each optic	1
Light colour	White
Required components:	

OPTICAL RESULTS (SIMULATED):

CREE LED

LED XP-G
 FWHM / FWTM 28.0° / 48.0°
 Efficiency 92 %
 Peak intensity 3.6 cd/lm
 LEDs/each optic 1
 Light colour White
 Required components:

CREE LED

LED XP-G2
 FWHM / FWTM 29.0° / 49.0°
 Efficiency 92 %
 Peak intensity 3.5 cd/lm
 LEDs/each optic 1
 Light colour White
 Required components:

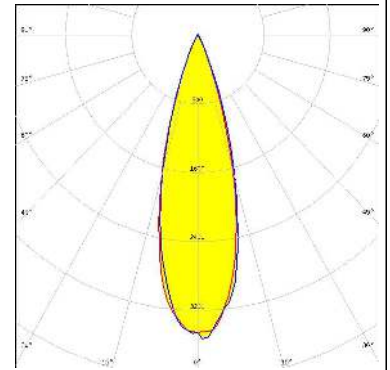

CREE LED

LED XP-G2 HE
 FWHM / FWTM 30.0° / 51.0°
 Efficiency 92 %
 Peak intensity 3 cd/lm
 LEDs/each optic 1
 Light colour White
 Required components:

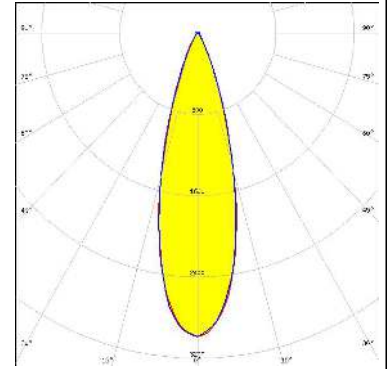

CREE LED



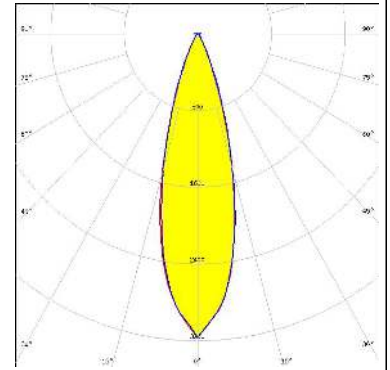

LED XP-G3
 FWHM / FWTM 28.0° / 51.0°
 Efficiency 94 %
 Peak intensity 3.2 cd/lm
 LEDs/each optic 1
 Light colour White
 Required components:

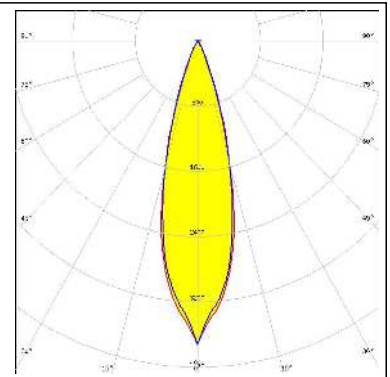
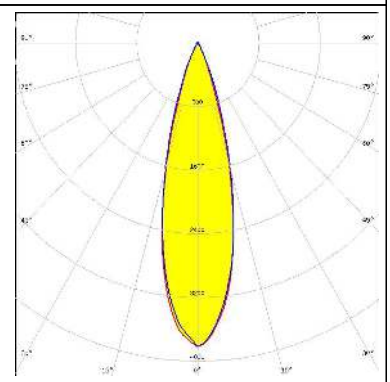
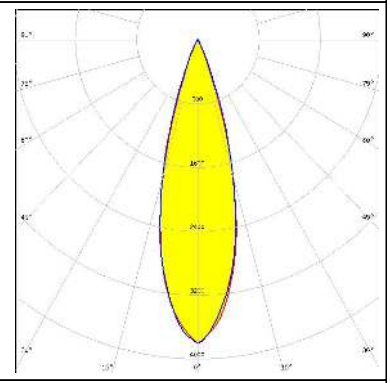
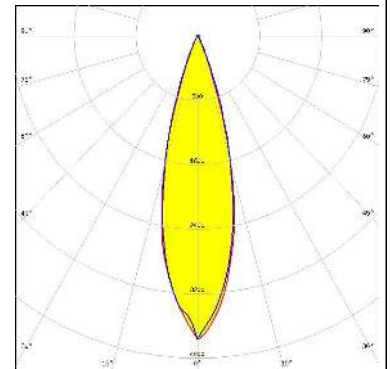

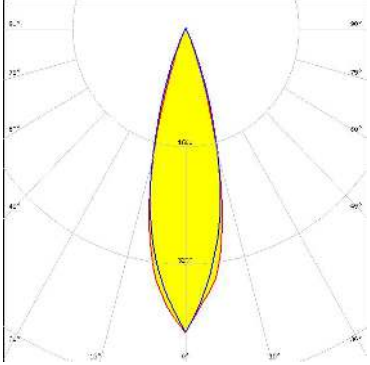

OPTICAL RESULTS (SIMULATED):

<p>CREE LED</p> <p>LED: XT-E FWHM / FWTM: 27.0° / 47.0° Efficiency: 93 % Peak intensity: 3.7 cd/lm LEDs/each optic: 1 Light colour: White Required components:</p>	
<p>LUMILEDS</p> <p>LED: LUXEON HL2Z FWHM / FWTM: 28.0° / 48.0° Efficiency: 95 % Peak intensity: 3.8 cd/lm LEDs/each optic: 1 Light colour: White Required components:</p>	
<p>LUMILEDS</p> <p>LED: LUXEON SunPlus 20 Line (120 deg) FWHM / FWTM: 29.0° / 47.0° Efficiency: 96 % Peak intensity: 3.8 cd/lm LEDs/each optic: 1 Light colour: White Required components:</p>	
<p>LUMILEDS</p> <p>LED: LUXEON SunPlus 20 Line (150 deg) FWHM / FWTM: 28.0° / 45.0° Efficiency: 91 % Peak intensity: 3.8 cd/lm LEDs/each optic: 1 Light colour: White Required components:</p>	

OPTICAL RESULTS (SIMULATED):

 LED LUXEON Z ES FWHM / FWTM 27.0° / 45.0° Efficiency 94 % Peak intensity 4.1 cd/lm LEDs/each optic 1 Light colour White Required components:	
 LED NF2x757A FWHM / FWTM 27.0° / 47.0° Efficiency 93 % Peak intensity 3.7 cd/lm LEDs/each optic 1 Light colour White Required components:	
 LED NSSW157T FWHM / FWTM 28.0° / 43.0° Efficiency 93 % Peak intensity 4 cd/lm LEDs/each optic 1 Light colour White Required components:	
 <small>Osram Semiconductors</small> LED OSOLON Square PC FWHM / FWTM 29.0° / 46.0° Efficiency 92 % Peak intensity 3.6 cd/lm LEDs/each optic 1 Light colour White Required components:	

OPTICAL RESULTS (SIMULATED):

 OSRAM Opto Semiconductors	
LED	OSLON SSL 150
FWHM / FWTM	29.0° / 44.0°
Efficiency	93 %
Peak intensity	4 cd/lm
LEDs/each optic	1
Light colour	White
Required components:	
 OSRAM Opto Semiconductors	
LED	OSLON SSL 80
FWHM / FWTM	29.0° / 46.0°
Efficiency	92 %
Peak intensity	3.8 cd/lm
LEDs/each optic	1
Light colour	White
Required components:	
 SECOIL SEMICONDUCTOR	
LED	Z5P
FWHM / FWTM	28.0° / 46.0°
Efficiency	92 %
Peak intensity	3.7 cd/lm
LEDs/each optic	1
Light colour	White
Required components:	

GENERAL INFORMATION:

NOTE: The typical beam angle will be changed by different color, chip size and chip position tolerance. The typical total beam angle is the full angle measured where the luminous intensity is half of the peak value.

MATERIALS:

As part of our continuous research and improvement processes, and to ensure the best possible quality and availability of our products, LEDiL reserves the right to change material grades without notice.

PRODUCT DATA USER AGREEMENT AND DISCLAIMER:

The measured data in the provided downloadable LEDiL Product Datasheets and Mechanical 2D-Drawings is rounded and provided as reference for planning. LEDiL Oy's optical specifications have been verified by conducting performance testing of the products in accordance with the company's quality system. The reported data are averaged results of multiple measurements with typical variation. LEDiL Oy reserves the right to without prior notification make changes and improvements to its products.

LEDiL Oy assumes neither warranty, nor guarantee nor any other liability of any kind for the contents and correctness of the provided data. The provided data has been generated with highest diligence but the provided data may in reality not represent the complete possible variation range of all intrinsic parameters. Therefore, in certain cases a deviation from the provided data could occur.

LEDiL Oy reserves the right to undertake technical changes of its products without further notification which could lead to changes in the provided data. LEDiL Oy assumes no liability of any kind for the possible deviation from any provided data or any other damage resulting from the usage of the provided data.

The user agrees to this disclaimer and user agreement with the download or usage of the provided files.

LEDiL Oy

Joensuunkatu 13
FI-24240 SALO
Finland

LEDiL Inc.

228 West Page Street
Suite D
Sycamore IL 60178
USA

Ledil Optics Technology (Shenzhen) Co., Ltd.

405 , Block B
Casic Motor Building
Shenzhen 518057
P.R.CHINA

Local sales and technical support

[www.ledil.com/
where_to_buy](http://www.ledil.com/where_to_buy)

Shipping locations

Salo, Finland
Hong Kong, China

Distribution Partners

[www.ledil.com/
where_to_buy](http://www.ledil.com/where_to_buy)