

## RF CHARACTERISTICS

Frequency range : **0 - 18 GHz**  
Impedance : **50 Ohms**

Frequency (GHz)	DC - 3	3 - 8	8 - 12.4	12.4 - 18
VSWR max	<b>1.20</b>	<b>1.30</b>	<b>1.40</b>	<b>1.50</b>
Insertion loss max	<b>0.20 dB</b>	<b>0.30 dB</b>	<b>0.40 dB</b>	<b>0.50 dB</b>
Isolation min	<b>80 dB</b>	<b>70 dB</b>	<b>60 dB</b>	<b>60 dB</b>
Average power (*)	<b>240 W</b>	<b>150 W</b>	<b>120 W</b>	<b>100 W</b>

## ELECTRICAL CHARACTERISTICS

Actuator : **NORMALLY OPEN**  
Nominal current \*\* : **102 mA**  
Actuator voltage (Vcc) : **28V (24 to 30V)**  
Terminals : **solder pins (250°C max. / 30 sec.)**  
TTL inputs (E) - High level : **2.2 to 5.5 V / 800µA at 5.5 V**  
- Low level : **0 to 0.8 V / 20µA at 0.8 V**

## MECHANICAL CHARACTERISTICS

Connectors : **SMA female per MIL-C 39012**  
Life : **2 million cycles**  
Switching Time\*\*\* : **< 10 ms**  
Construction : **Splashproof**  
Weight : **< 100 g**

## ENVIRONMENTAL CHARACTERISTICS

Operating temperature range : **-40°C to +85°C**  
Storage temperature range : **-55°C to +85°C**

(\* Average power at 25°C per RF Path)

(\*\* At 25° C ±10%)

(\*\*\* Nominal voltage ; 25° C)



PAGE 2/2

ISSUE 09-03-21

SERIE : SPDT ZC

PART NUMBER : R585473300

**DRAWING**

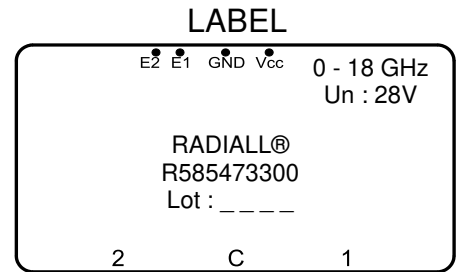
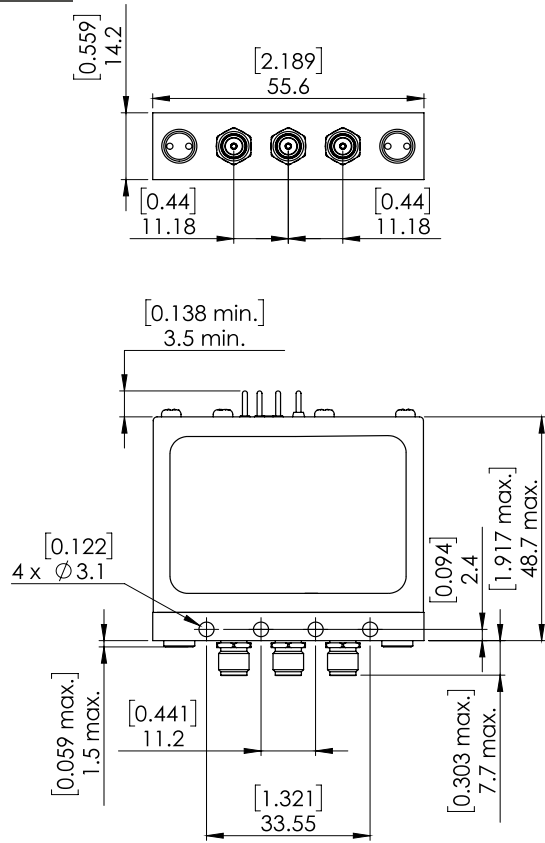

General tolerances : ±0,5 mm [0,02 in]

**SCHEMATIC DIAGRAM**

RF input

50Ω Termination

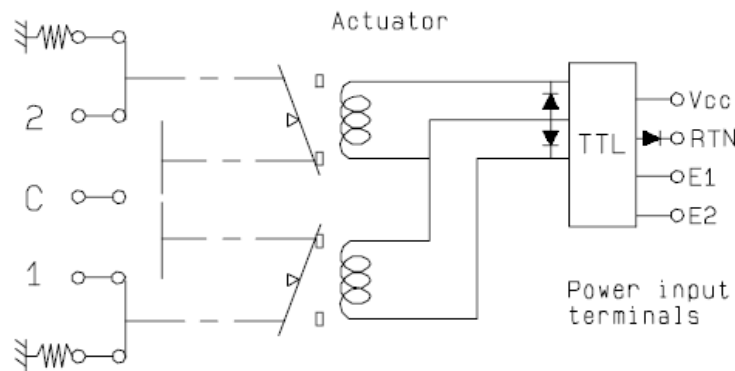

50Ω Termination

TTL input	RF Continuity
E1=1 / E2=0	C↔1 / 2↔50Ω
E1=0 / E2=1	C↔2 / 1↔50Ω
E1=0 / E2=0	1↔50Ω / 2↔50Ω
E1=1 / E2=1	Forbidden