

Low Noise, High Performance Operational Amplifiers

April 1993

Features

- **Low Noise** $3.0\text{nV}/\sqrt{\text{Hz}}$ at 1kHz
- **Wide Bandwidth** 10MHz (Compensated)
100MHz (Uncompensated)
- **High Slew Rate** $10\text{V}/\mu\text{s}$ (Compensated)
 $50\text{V}/\mu\text{s}$ (Uncompensated)
- **Low Offset Voltage Drift** $3\mu\text{V}/^\circ\text{C}$
- **High Gain** $1 \times 10^6\text{V}/\text{V}$
- **High CMRR/PSRR** 100dB
- **High Output Drive Capability** 30mA

Applications

- High Quality Audio Preamplifiers
- High Q Active Filters
- Low Noise Function Generators
- Low Distortion Oscillators
- Low Noise Comparators
- For Further Design Ideas, See Application Note 554

Description

The HA-5101/5111 are dielectrically isolated operational amplifiers featuring low noise and high performance. Both amplifiers have an excellent noise voltage density of $3.0\text{nV}/\sqrt{\text{Hz}}$ at 1kHz. The uncompensated HA-5111 is stable at a minimum gain of 10 and has the same DC specifications as the unity gain stable HA-5101. The difference in compensation yields a 100MHz gain-bandwidth product and a $50\text{V}/\mu\text{s}$ slew rate for the HA-5111 versus a 10MHz unity gain bandwidth and a $10\text{V}/\mu\text{s}$ slew rate for the HA-5101.

DC characteristics of the HA-5101/5111 assure accurate performance. The 0.5mV offset voltage is externally adjustable and offset voltage drift is just $3\mu\text{V}/^\circ\text{C}$. An offset current of only 30nA reduces input current errors and an open loop voltage gain of $1 \times 10^6\text{V}/\text{V}$ increases loop gain for low distortion amplification.

The HA-5101/5111 are ideal for audio applications, especially low-level signal amplifiers such as microphone, tape head and phono cartridge preamplifiers. Additionally, it is well suited for low distortion oscillators, low noise function generators and high Q filters.

Pinouts (See Ordering Information on Next Page)

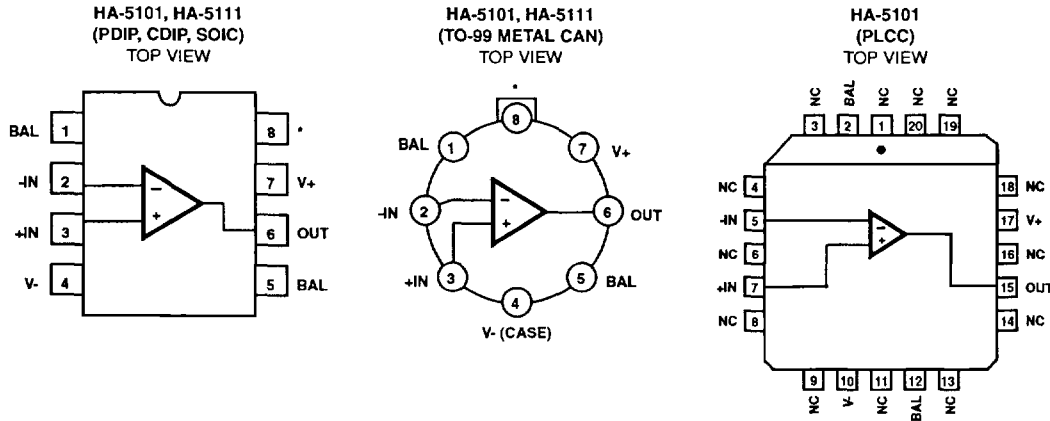

*HA-5101 No Connect
HA-5111 Compensation

HA-5101, HA-5111

Ordering Information

PART NUMBER	TEMPERATURE RANGE	PACKAGE
HA2-5101-2	-55°C to +125°C	8 Pin Can
HA2-5101-5	0°C to +75°C	8 Pin Can
HA3-5101-5	0°C to +75°C	8 Lead Plastic DIP
HA4P5101-5	0°C to +75°C	20 Lead PLCC
HA7-5101-2	-55°C to +125°C	8 Lead Ceramic DIP
HA7-5101-5	0°C to +75°C	8 Lead Ceramic DIP
HA9P5101-5	0°C to +75°C	8 Lead SOIC
HA9P5101-9	-40°C to +85°C	8 Lead SOIC

PART NUMBER	TEMPERATURE RANGE	PACKAGE
HA2-5111-2	-55°C to +125°C	8 Pin Can
HA2-5111-5	0°C to +75°C	8 Pin Can
HA3-5111-5	0°C to +75°C	8 Lead Plastic DIP
HA7-5111-2	-55°C to +125°C	8 Lead Ceramic DIP
HA7-5111-5	0°C to +75°C	8 Lead Ceramic DIP
HA9P5111-5	0°C to +75°C	8 Lead SOIC
HA9P5111-9	-40°C to +85°C	8 Lead SOIC

Schematic

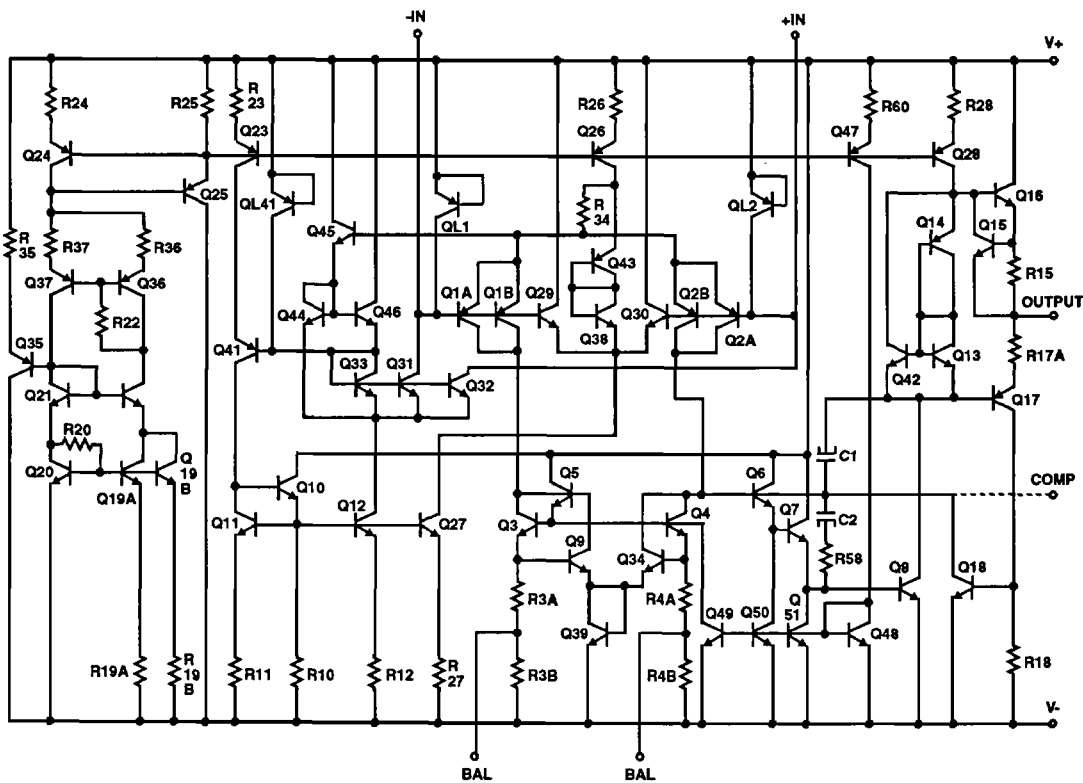

2
OPERATIONAL AMPLIFIERS

Specifications HA-5101, HA-5111

Absolute Maximum Ratings (Note 1)

$T_A = +25^\circ\text{C}$ Unless Otherwise Specified
Voltage Between V+ and V- Terminals 40.0V
Differential Input Voltage 7V
Voltage (at Any Lead) $\pm V_{\text{SUPPLY}}$
Output Current Full Short Circuit Protection
Junction Temperature (Note 8) $+175^\circ\text{C}$
Junction Temperature (Plastic Packages) $+150^\circ\text{C}$
Lead Temperature (Soldering 10 Sec.) $+300^\circ\text{C}$

Operating Conditions

Operating Temperature Range	HA-5101/5111-2 -55°C to $+125^\circ\text{C}$
	HA-5101/5111-5 0°C to $+75^\circ\text{C}$
	HA-5101/5111-9 -40°C to $+85^\circ\text{C}$
Storage Temperature Range -65°C to $+150^\circ\text{C}$	

CAUTION: Stresses above those listed in "Absolute Maximum Ratings" may cause permanent damage to the device. This is a stress only rating and operation of the device at these or any other conditions above those indicated in the operational sections of this specification is not implied.

Electrical Specifications $V_+ = +15\text{V}$, $V_- = -15\text{V}$, $R_S = 100\Omega$, $R_L = 2\text{k}\Omega$, $C_L = 50\text{pF}$, Unless Otherwise Specified.

PARAMETER	TEMP	HA-5101-2, -5 HA-5111-2, -5			HA-5101-9 HA-5111-9			UNITS
		MIN	TYP	MAX	MIN	TYP	MAX	
INPUT CHARACTERISTICS								
Offset Voltage	$+25^\circ\text{C}$	-	0.5	3	-	0.5	3	mV
	Full	-	-	4	-	-	4	mV
Offset Voltage Drift	Full	-	3	-	-	3	-	$\mu\text{V}/^\circ\text{C}$
Bias Current	$+25^\circ\text{C}$	-	100	200	-	100	200	nA
	Full	-	-	325	-	-	325	nA
Offset Current	$+25^\circ\text{C}$	-	30	75	-	30	75	nA
	Full	-	-	125	-	-	125	nA
Input Resistance	$+25^\circ\text{C}$	-	500	-	-	500	-	$\text{k}\Omega$
Common Mode Range	Full	± 12	-	-	± 12	-	-	V
TRANSFER CHARACTERISTICS								
Large Signal Voltage Gain (Note 2)	$+25^\circ\text{C}$	-	1000	-	-	1000	-	KV/V
	Full	100	250	-	100	250	-	KV/V
Common Mode Rejection Ratio (Note 3)	Full	80	100	-	80	100	-	dB
Small Signal Bandwidth HA-5101 ($A_V = 1$)	$+25^\circ\text{C}$	-	10	-	-	10	-	MHz
Minimum Stable Gain	Full	1	-	-	1	-	-	V/V
	Full	10	-	-	10	-	-	V/V
Gain Bandwidth Product HA-5111 ($A_V = 10$)	$+25^\circ\text{C}$	-	100	-	-	100	-	MHz
OUTPUT CHARACTERISTICS								
Output Voltage Swing	Full	± 12	± 13	-	± 12	± 13	-	V
	Full	± 12	± 13	-	± 12	± 13	-	V
($V_{PS} = \pm 18$, $R_L = 600$)	$+25^\circ\text{C}$	± 15	-	-	± 15	-	-	V
Output Current (Note 4)	$+25^\circ\text{C}$	25	30	-	25	30	-	mA
Full Power Bandwidth (Note 5)	$+25^\circ\text{C}$	95	160	-	95	160	-	kHz
	$+25^\circ\text{C}$	630	790	-	630	790	-	kHz
Output Resistance	$+25^\circ\text{C}$	-	110	-	-	110	-	Ω
Maximum Load Capacitance	$+25^\circ\text{C}$	-	800	-	-	800	-	pF

Specifications HA-5101, HA-5111

Electrical Specifications $V_+ = +15V$, $V_- = -15V$, $R_s = 100\Omega$, $R_L = 2k\Omega$, $C_L = 50pF$, Unless Otherwise Specified. (Continued)

PARAMETER	TEMP	HA-5101-2, -5 HA-5111-2, -5			HA-5101-9 HA-5111-9			UNITS
		MIN	TYP	MAX	MIN	TYP	MAX	
TRANSIENT RESPONSE (Note 6)								
Rise Time								
HA-5101	+25°C	-	50	100	-	50	100	ns
HA-5111	+25°C	-	30	60	-	30	60	ns
Overshoot								
HA-5101	+25°C	-	20	35	-	20	35	%
HA-5111	+25°C	-	20	40	-	20	40	%
Slew Rate								
HA-5101	+25°C	6	10	-	6	10	-	V/ μ s
HA-5111	+25°C	40	50	-	40	50	-	V/ μ s
Settling Time (Note 7)								
HA-5101 0.01%	-	-	2.6	-	-	2.6	-	μ s
HA-5111 0.01%	-	-	0.5	-	-	0.5	-	μ s
NOISE CHARACTERISTICS (Note 10)								
Input Noise Voltage								
f = 10Hz	+25°C	-	5	7	-	5	7	nV/ \sqrt{Hz}
f = 1kHz	+25°C	-	3.0	4.0	-	3.0	4.0	nV/ \sqrt{Hz}
Input Noise Current								
f = 10Hz	+25°C	-	4.0	9	-	4.0	9	pA/ \sqrt{Hz}
f = 1kHz	-	-	0.6	2.5	-	0.6	2.5	pA/ \sqrt{Hz}
Broadband Noise Voltage f = DC to 30kHz	+25°C	-	0.870	-	-	0.870	-	μ Vrms
POWER SUPPLY CHARACTERISTICS								
Supply Current HA-5101/5111	Full	-	4	6	-	4	7	mA
Power Supply Rejection Ratio (Note 9)	Full	80	100	-	80	100	-	dB

NOTES:

1. Absolute maximum ratings are limiting values, applied individually, beyond which the serviceability of the circuit may be impaired. Functional operability under any of these conditions is not necessarily implied.
2. $V_{OUT} = \pm 10V$, $R_L = 2K$.
3. $V_{CM} = \pm 10V$.
4. Output current is measured with $V_{OUT} = \pm 15V$ with $V_{SUPPLY} = \pm 18V$.
5. Full power bandwidth is guaranteed by equation: Full power bandwidth = $\frac{\text{Slew Rate}}{2\pi V_{Peak}}$, $V_{Peak} = 10V$
6. Refer to Test Circuits section of the data sheet.
7. Settling time is measured to 0.01% of final value for a 10V output step, and $A_v = -10$ for HA-5111 and 0.01% of final value for a 10V output step, $A_v = -1$ for HA-5101.
8. See Thermal Constants in "Die Characteristics" text. Maximum power dissipation, including output load, must be designed to maintain the maximum junction temperature below +175°C for hermetic packages, and below +150°C for the plastic packages.
9. Delta $V_{SUPPLY} = \pm 5V$.
10. The limits for these parameters are guaranteed based on lab characterization, and reflect lot-to-lot variation.

2
**OPERATIONAL
AMPLIFIERS**

Die Characteristics

Transistor Count	54
Die Dimensions	69 x 69 x 19 mils (1800 x 1800 x 480 μ m)
Substrate Potential*	V- or Float
Process	Bipolar DI

* The Substrate may be left floating (Insulating Die Mount) or it may be mounted on a conductor at V- potential.

Thermal Constants ($^{\circ}$ C/W)	θ_{JA}	θ_{JC}
HA2-5101/5111 (Can)	114	35
HA3-5101/5111 (PDIP)	94	32
HA4P5101 (PLCC)	74	33
HA7-5101/5111 (CDIP)	115	35
HA9P5101/5111 (SOIC)	157	43

Test Circuits

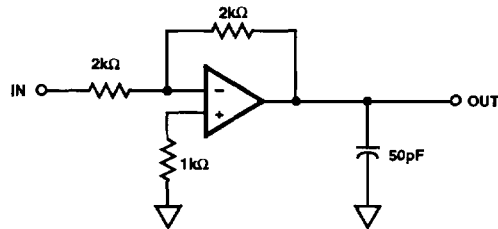

FIGURE 1. HA-5101 LARGE SIGNAL RESPONSE CIRCUIT

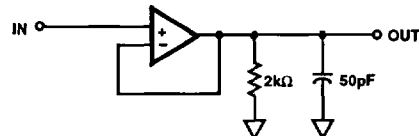
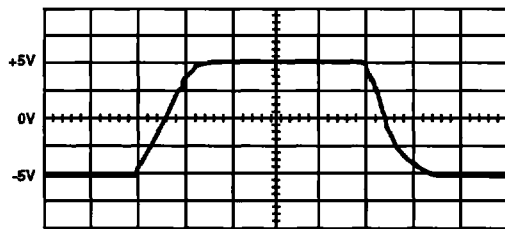
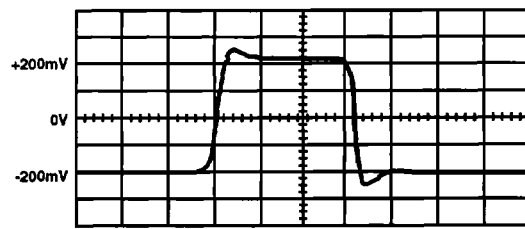

FIGURE 2. HA-5101 SMALL SIGNAL RESPONSE CIRCUIT



Ch. 1 = 2.5V/Div.
Timebase = 200ns/Div.

FIGURE 3. HA-5111 LARGE SIGNAL TRANSIENT RESPONSE



Ch. 1 = 100mV/Div.
Timebase = 100ns/Div.

FIGURE 4. HA-5111 SMALL SIGNAL TRANSIENT RESPONSE

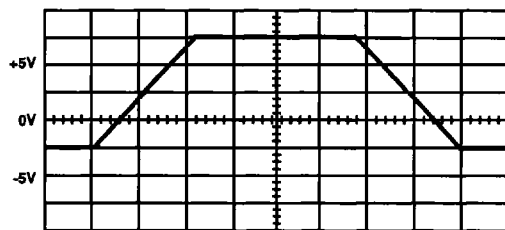

Ch. 1 = 2.5V/Div.
Timebase = 1.00 μ s/Div.

FIGURE 5. HA-5101 LARGE SIGNAL TRANSIENT RESPONSE

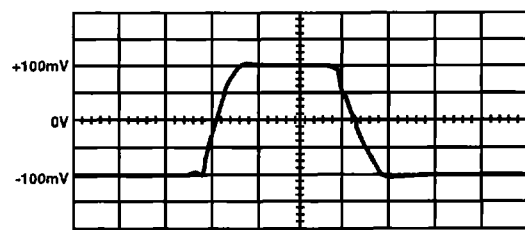

Ch. 1 = 50mV/Div.
Timebase = 100ns/Div.

FIGURE 6. HA-5101 SMALL SIGNAL TRANSIENT RESPONSE

Test Circuits (Continued)

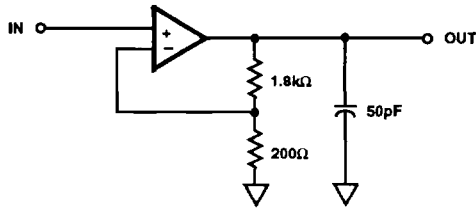

FIGURE 7. HA-5111 LARGE AND SMALL SIGNAL RESPONSE CIRCUIT

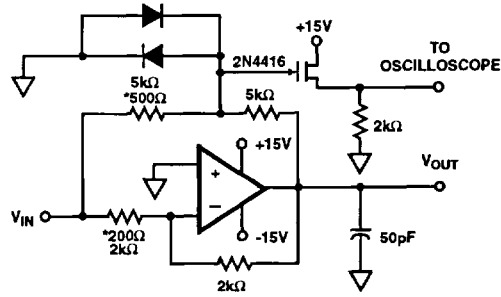

FIGURE 8. SETTLING TIME CIRCUIT

- $A_V = -1$ (HA-5101), $*A_V = -10$ (HA-5111)
- Feedback and summing resistors should be 0.1% matched.
- Clipping diodes are optional, HP5082-2810 recommended.

Typical Performance Curves

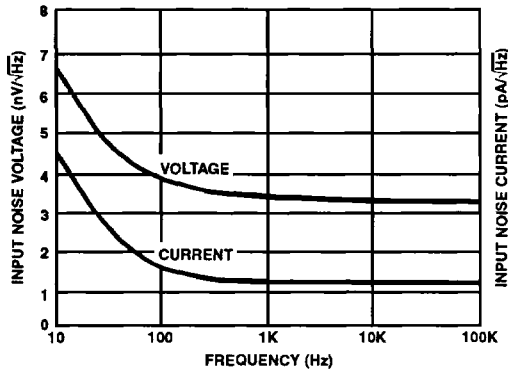

FIGURE 9. HA-5101/11 NOISE SPECTRUM

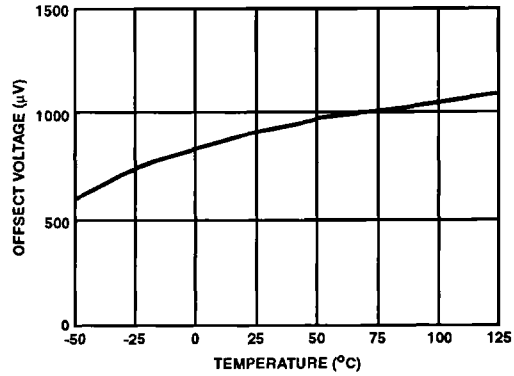
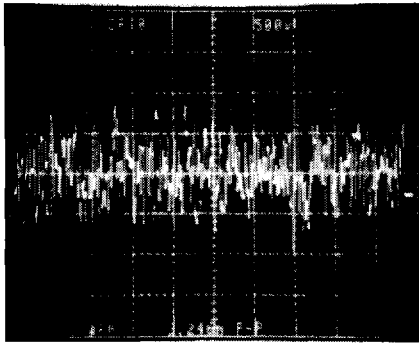
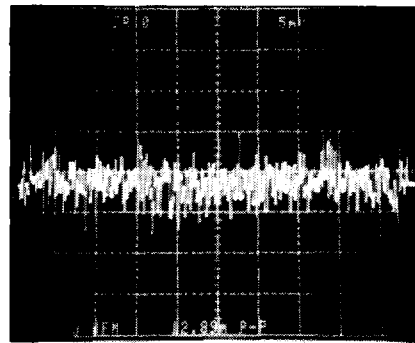

FIGURE 10. OFFSET VOLTAGE vs TEMPERATURE

PEAK-TO-PEAK NOISE 0.1Hz TO 10Hz
 $A_V = 25000$, $V_{CC} = \pm 15V$ (2.25μVp-p RTO)



PEAK-TO-PEAK TOTAL NOISE 0.1Hz TO 1MHz
 $A_V = 25000$, $V_{CC} = \pm 15V$ (12.89mVp-p RTO)



Typical Performance Curves (Continued)

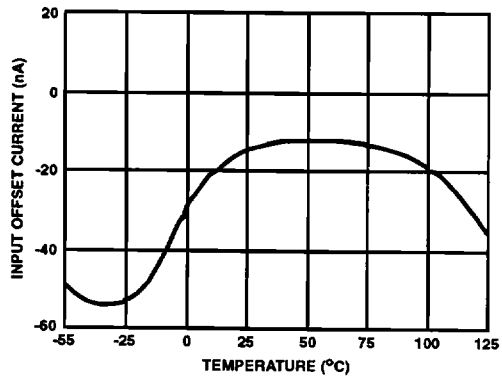

FIGURE 11. INPUT OFFSET CURRENT vs TEMPERATURE

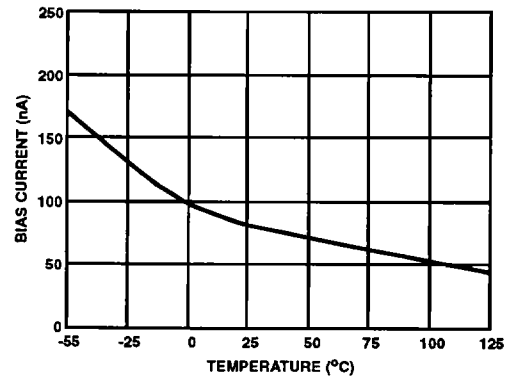

FIGURE 12. INPUT BIAS CURRENT vs TEMPERATURE

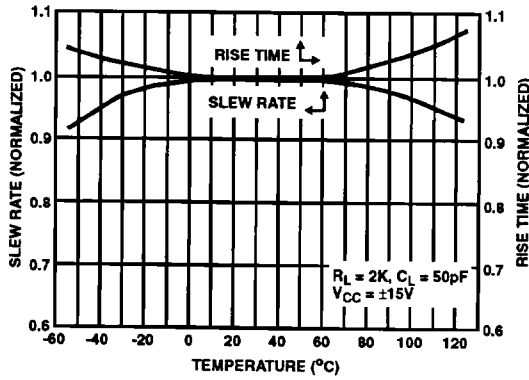

FIGURE 13. SLEW RATE/RISE TIME vs TEMPERATURE

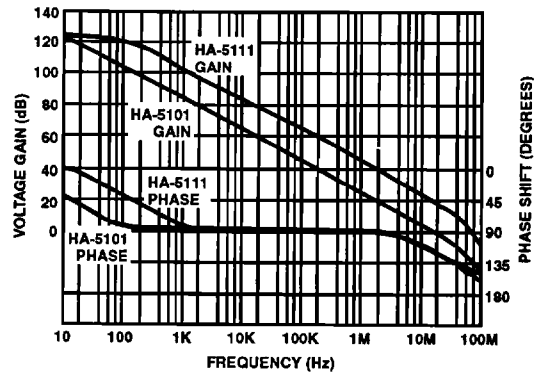

FIGURE 14. OPEN-LOOP GAIN/PHASE vs FREQUENCY

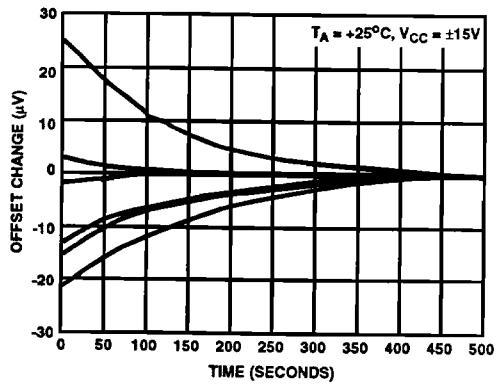

FIGURE 15. INPUT OFFSET WARMUP DRIFT vs TIME (Normalized To Zero Final Value) (Six Representative Units)

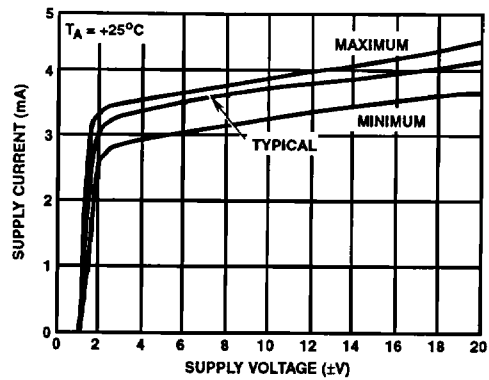

FIGURE 16. SUPPLY CURRENT vs SUPPLY VOLTAGE

Typical Performance Curves (Continued)

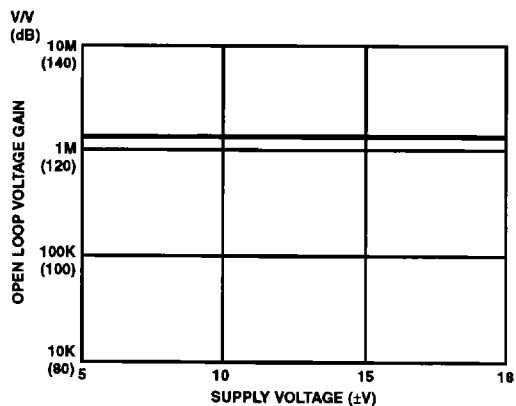

FIGURE 17. DC OPEN-LOOP VOLTAGE GAIN vs SUPPLY VOLTAGE

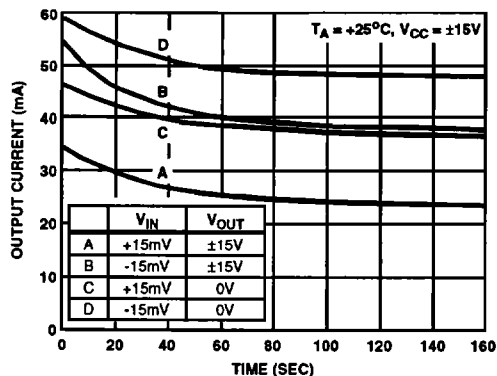

FIGURE 18. SHORT CIRCUIT CURRENT vs TIME

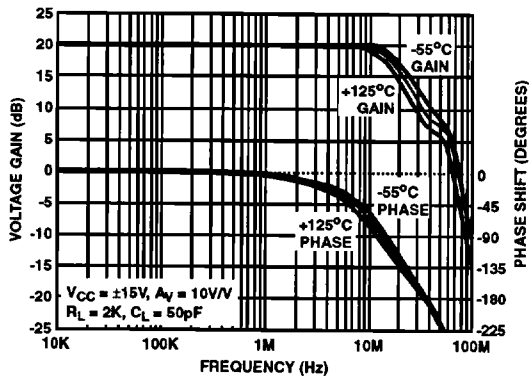

FIGURE 19. HA-5111 CLOSED-LOOP GAIN AND PHASE AT HIGH AND LOW TEMPERATURE (Typical Response of One Amplifier)

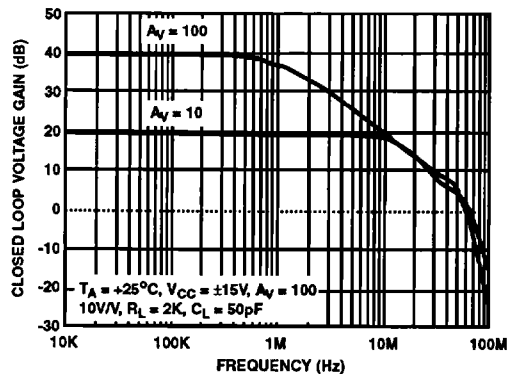

FIGURE 20. HA-5111 CLOSED-LOOP VOLTAGE GAIN vs FREQUENCY AT DIFFERENT CLOSED-LOOP GAINS

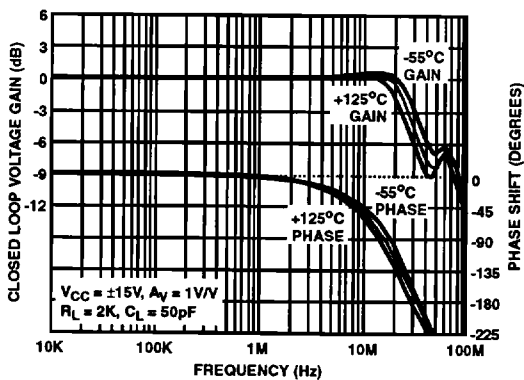

FIGURE 21. HA-5101 CLOSED-LOOP GAIN AND PHASE AT HIGH AND LOW TEMPERATURE (Typical Response of One Amplifier)

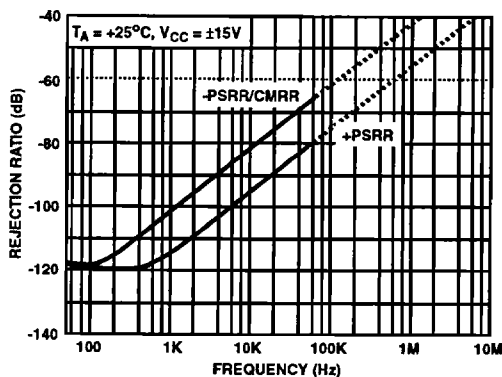

FIGURE 22. HA-5111 REJECTION RATIOS vs FREQUENCY

Typical Performance Curves (Continued)

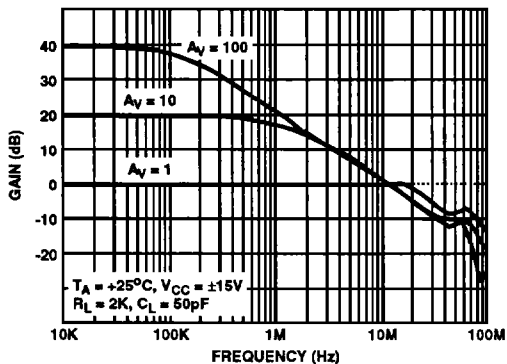

FIGURE 23. HA-5101 CLOSED-LOOP VOLTAGE GAIN vs FREQUENCY AT DIFFERENT CLOSED-LOOP GAINS

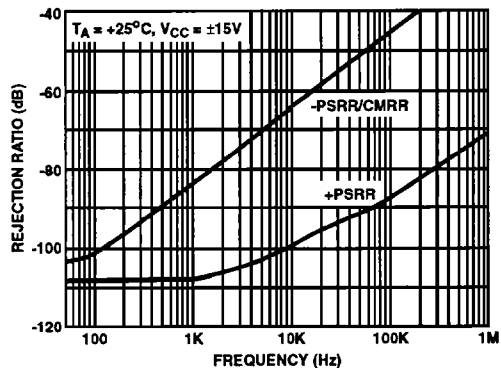

FIGURE 24. HA-5101 REJECTION RATIOS vs FREQUENCY

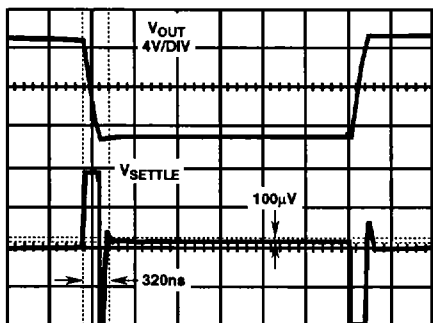

FIGURE 25. HA-5111 SETTLING WAVEFORM 500ns/DIV.

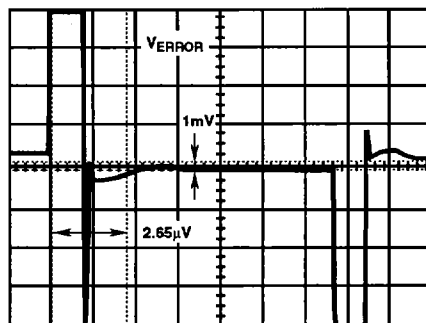

FIGURE 26. HA-5101 SETTLING WAVEFORM 1.5µs/DIV

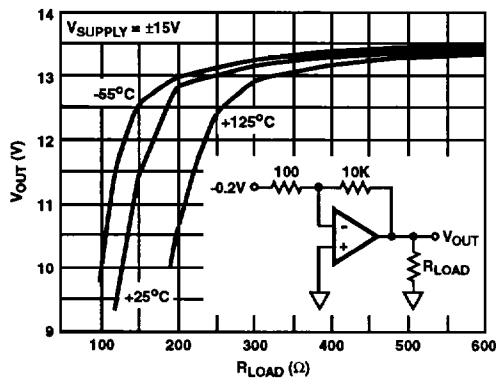

FIGURE 27. HA-5101 V_{OUT} vs R_L

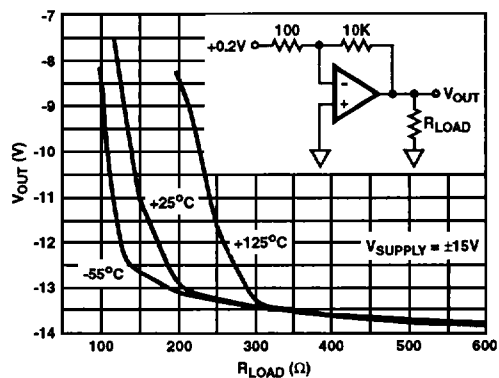

FIGURE 28. HA-5101 V_{OUT} vs R_L

Applications Information

Operation At ±5V Supply

The HA-5101/11 performs well at $V_{CC} = \pm 5V$ exhibiting typical characteristics as listed below:

I_{CC}	3.7	mA
V_{IO}	0.5	mV
I_{BIAS}	56	nA
A_{VOL} ($V_O = \pm 3V$)	106	kV/V
V_{OUT}	3.7	V
I_{OUT}	13	mA
CMRR ($\Delta V_{CM} = \pm 2.5V$)	90	dB
PSRR ($\Delta V_{CC} = 0.5V$)	90	dB
Unity Bandwidth (5101)	10	MHz
GBW (5111)	100	MHz
Slew Rate (5101)	7	V/ μ s
Slew Rate (5111)	40	V/ μ s

Offset Adjustment

* The following is the recommended V_{IO} adjust configuration:

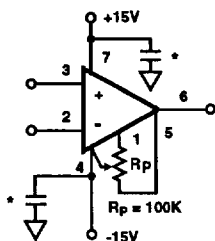

* Proper decoupling is always recommended, 0.1 μ F high quality capacitor should be at or very near the device's supply pins.

Compensation

An external compensation capacitor can be used with the HA-5111 connected between pin 8 and ground (or V_- , V_+ not Recommended). A plot of gain bandwidth product vs compensation capacitor has been included as a design aid. The capacitor should be a high frequency type mounted near the device leads to minimize parasitics.

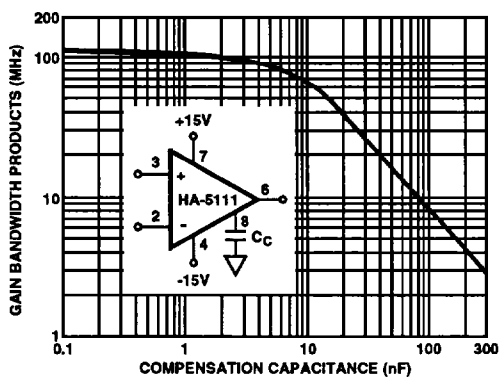

Input Protection

The HA-5101/11 has built-in back-to-back protection diodes which will limit the differential input voltage to approximately 7V. If the 5101/11 will be used in conditions where that voltage may be exceeded, then current limiting resistors must be used. No more than 25mA should be allowed to flow in the HA-5101/11's input.

Comparator Circuit

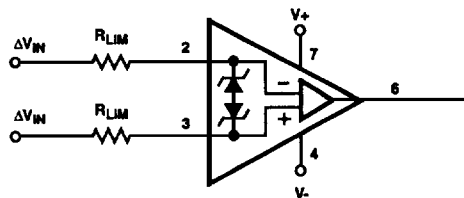

Choose R_{LIM} Such That:
$$\frac{(\Delta V_{INMAX} - 7V)}{25mA} \leq 2R_{LIM}$$

Output Saturation

When an op amp is overdriven, output devices can saturate and sometimes take a long time to recover. Saturation can be avoided (sometimes) by using circuits such as:

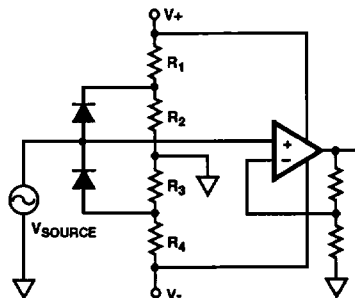

If saturation cannot be avoided the HA-5101/11 recovers from a 25% overdrive in about 6.5 μ s (see photos).

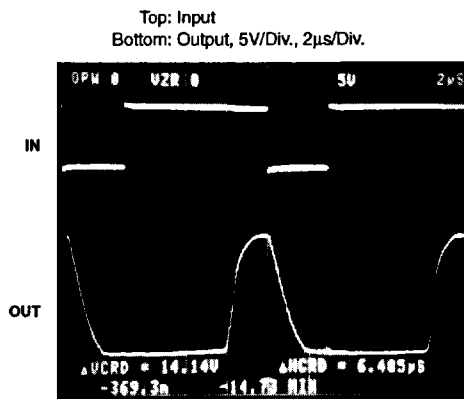

Output is overdriven negative and recovers in 6 μ s.