



HA-5170

Precision JFET Input Operational Amplifier

March 1993

Features

- Low Offset Voltage.....100 μ V
- Low Offset Voltage Drift2 μ V/ $^{\circ}$ C
- Low Noise.....10nV/ $\sqrt{\text{Hz}}$
- High Open Loop Gain600kV/V
- Wide Bandwidth.....8MHz
- Unity Gain Stable
- Applications
- High Gain Instrumentation Amplifiers
- Precision Data Acquisition
- Precision Integrators
- Precision Threshold Detectors
- For Further Design Ideas, Refer to App. Note 540

Description

The Harris HA-5170 is a precision, JFET input, operational amplifier which features low noise, low offset voltage and low offset voltage drift. Constructed using FET/Bipolar technology, the Harris Dielectric Isolation (DI) process, and laser trimming this amplifier offers low input bias and offset currents. This operational amplifier design also completely eliminates the troublesome errors due to warm-up drift.

Complementing these excellent input characteristics are dynamic performance characteristics never before available from precision operational amplifiers. An 8V/ μ s slew rate and 8MHz bandwidth allow the designer to extend precision instrumentation applications in both speed and bandwidth. These characteristics make the HA-5170 well suited for precision integrator amplifier designs.

The superior input characteristics also make the HA-5170 ideally suited for transducer signal amplifiers, precision voltage followers and precision data acquisition systems. For application assistance, please refer to Application Note 540 addressing specifically this device.

Military version (-8) product and data sheets available upon request.

Ordering Information

PART NUMBER	TEMPERATURE RANGE	PACKAGE
HA2-5170-2	-55 $^{\circ}$ C to +125 $^{\circ}$ C	8 Pin Can
HA2-5170-5	0 $^{\circ}$ C to +75 $^{\circ}$ C	8 Pin Can
HA7-5170-2	-55 $^{\circ}$ C to +125 $^{\circ}$ C	8 Lead Ceramic DIP
HA7-5170-5	0 $^{\circ}$ C to +75 $^{\circ}$ C	8 Lead Ceramic DIP

Pinouts

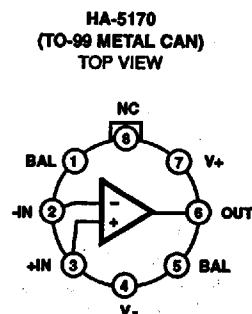
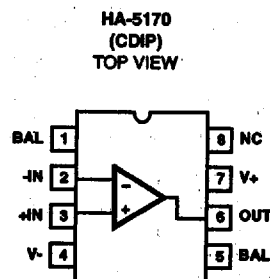

Absolute Maximum Ratings (Note 1)

$T_A = +25^\circ\text{C}$, Unless Otherwise Specified

Voltage Between V_+ and V_- Terminals	44.0V
Differential Input Voltage	30.0V
Output Short Circuit Duration	Indefinite
Junction Temperature (Note 2)	+175°C
Lead Temperature (Soldering 10 Sec.)	+300°C

Operating Conditions

Operating Temperature Range	
HA-5170-2	$-55^\circ\text{C} \leq T_A \leq +125^\circ\text{C}$
HA-5170-5	$0^\circ\text{C} \leq T_A \leq +75^\circ\text{C}$
Storage Temperature Range	
	$-65^\circ\text{C} \leq T_A \leq +150^\circ\text{C}$
Thermal Package Characteristics ($^\circ\text{C}/\text{W}$)	
	θ_{JA} θ_{JC}
Ceramic DIP	113 34
Can	105 32

CAUTION: Stresses above those listed in "Absolute Maximum Ratings" may cause permanent damage to the device. This is a stress only rating and operation of the device at these or any other conditions above those indicated in the operational sections of this specification is not implied.

Electrical Specifications $V_+ = +15\text{V}$, $V_- = -15\text{V}$, Unless Otherwise Specified

PARAMETER	TEMP	HA-5170-2 -55°C to $+125^\circ\text{C}$			HA-5170-5 0°C to $+75^\circ\text{C}$			UNITS	
		MIN	TYP	MAX	MIN	TYP	MAX		
INPUT CHARACTERISTICS									
Offset Voltage	+25°C	-	0.1	0.3	-	0.1	0.3	mV	
	Full	-	-	0.5	-	-	0.5	mV	
Average Offset Voltage Drift (Note 3)	Full	-	2	5	-	2	5	$\mu\text{V}/^\circ\text{C}$	
Bias Current	+25°C	-	20	100	-	20	100	pA	
	Full	-	3	30	-	0.1	2	nA	
Bias Current Average Drift	Full	-	3	-	-	3	-	$\text{pA}/^\circ\text{C}$	
Offset Current	+25°C	-	3	30	-	3	60	pA	
	Full	-	-	5	-	-	0.1	nA	
Offset Current Average Drift (Note 3)	Full	-	0.3	1	-	0.3	1	$\text{pA}/^\circ\text{C}$	
Common Mode Range	Full	± 10	+15.1	-	± 10	+15.1	-	V	
	Full		-12	-	-	-12	-	V	
Differential Input Capacitance	+25°C	-	80	100	-	80	100	pF	
Differential Input Resistance (Note 3)	+25°C	1×10^{10}	6×10^{10}	-	1×10^{10}	6×10^{10}	-	Ω	
Input Capacitance (Single Ended)	+25°C	-	12	-	-	12	-	pF	
Input Noise Voltage 0.1Hz to 10Hz (Note 3)	+25°C	-	0.5	5	-	0.5	5	$\mu\text{V}_{\text{p-p}}$	
Input Noise Voltage Density (Note 3)	+25°C	-	$f_o = 10\text{Hz}$	20	150	-	20	150	$\text{nV}/\sqrt{\text{Hz}}$
			$f_o = 100\text{Hz}$	12	50	-	12	50	$\text{nV}/\sqrt{\text{Hz}}$
			$f_o = 1000\text{Hz}$	10	25	-	10	25	$\text{nV}/\sqrt{\text{Hz}}$
Input Noise Current Density (Note 3)	+25°C	-	$f_o = 10\text{Hz}$	0.05	-	-	0.05	-	$\text{pA}/\sqrt{\text{Hz}}$
			$f_o = 100\text{Hz}$	0.01	-	-	0.01	-	$\text{pA}/\sqrt{\text{Hz}}$
			$f_o = 1000\text{Hz}$	0.01	0.1	-	0.01	0.1	$\text{pA}/\sqrt{\text{Hz}}$

2
**OPERATIONAL
 AMPLIFIERS**

Specifications HA-5170

Electrical Specifications $V_+ = +15V$, $V_- = -15V$, Unless Otherwise Specified

PARAMETER	TEMP	HA-5170-2 -55°C to +125°C			HA-5170-5 0°C to +75°C			UNITS
		MIN	TYP	MAX	MIN	TYP	MAX	
TRANSFER CHARACTERISTICS								
Large Signal Voltage Gain (Notes 4)	+25°C	300	600	-	300	600	-	kV/V
	Full	200	-	-	250	-	-	kV/V
Common Mode Rejection Ratio (Note 5)	Full	85	100	-	90	100	-	dB
Minimum Stable Gain	+25°C	1	-	-	1	-	-	V/V
Closed Loop Bandwidth ($A_{VCL} = +1$)	+25°C	4	8	-	4	8	-	MHz
OUTPUT CHARACTERISTICS								
Output Voltage Swing (Note 6)	+25°C	±10	±12	-	±10	±12	-	V
Full Power Bandwidth (Note 7)	+25°C	80	120	-	80	120	-	kHz
Output Current (Note 8)	+25°C	±10	±15	-	±10	±15	-	mA
Output Resistance (Note 3 & 9)	+25°C	-	45	100	-	45	100	Ω
TRANSIENT RESPONSE								
Rise Time	+25°C	-	45	100	-	45	100	ns
Slew Rate	+25°C	5	8	-	5	8	-	V/μs
Settling Time (Notes 3 & 10)	+25°C	-	1	5	-	1	5	μs
POWER SUPPLY CHARACTERISTICS								
Supply Current	Full	-	1.9	2.5	-	1.9	2.5	mA
Power Supply Rejection Ratio (Note 11)	Full	85	105	-	90	105	-	dB

NOTES:

- Absolute maximum ratings are limiting values, applied individually, beyond which the serviceable of the circuit may be impaired. Functional operable under any of these conditions is not necessarily implied.
- Maximum power dissipation must be designed to maintain junction temperature below +175°C.
- Parameter is not 100% tested. 90% of all units meet or exceed these specifications.
- $V_{OUT} = \pm 10V$, $R_L = 2k\Omega$.
- $\Delta V_{CM} = \pm 10VDC$.
- $R_L = 2k\Omega$.
- $R_L = 2k\Omega$; Full power bandwidth guaranteed based on slew rate measurement using $FPBW = \frac{SlewRate}{2\pi V_{PEAK}}$
- $V_{OUT} = \pm 10V$. I_{SC} turns on at $\pm 23mA$.
- Output resistance measured under open loop conditions ($f = 100Hz$).
- Settling time is measured to 0.1% of final value for a 10V output step and $A_V = -1$.
- $V_+ = +15V$, $V_- = -10V$ to $-20V$ and $V_- = -15V$, $V_+ = +10V$ to $+20V$.

Schematic

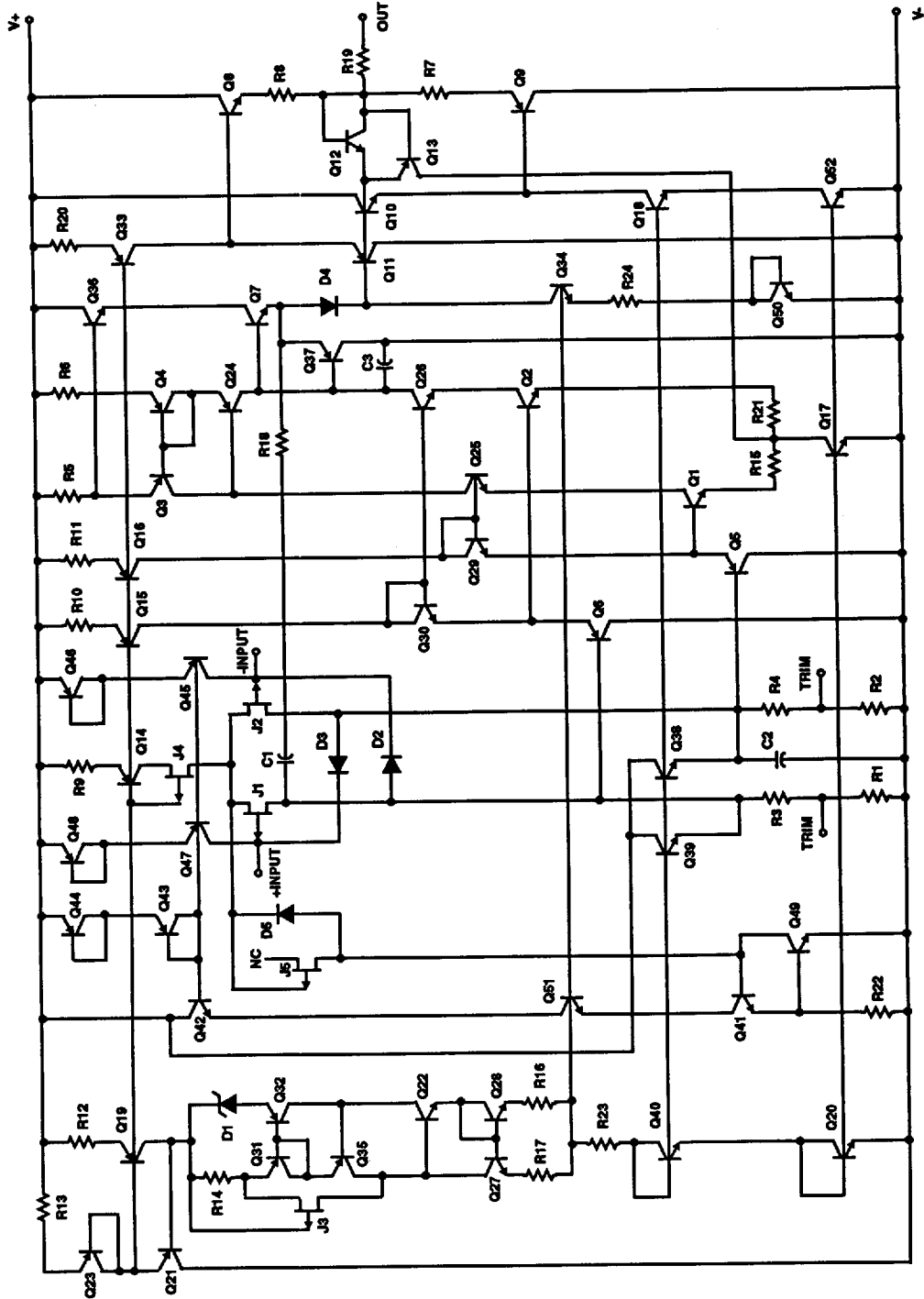

Test Circuits

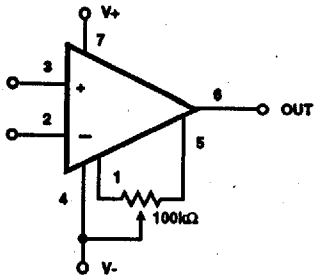

FIGURE 1. V_{OS} ADJUSTMENT

Tested Offset Adjustment Range is $|V_{OS} + 1mV|$ minimum referred to output. Typical range is $\pm 5mV$ with $R_T = 1k\Omega$ and $\pm 15mV$ with $R_T = 100k\Omega$.

LARGE SIGNAL RESPONSE

Vertical Scale: 5V/Div.
Horizontal Scale: 1 μ s/Div.

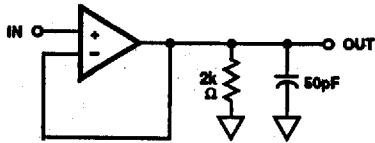
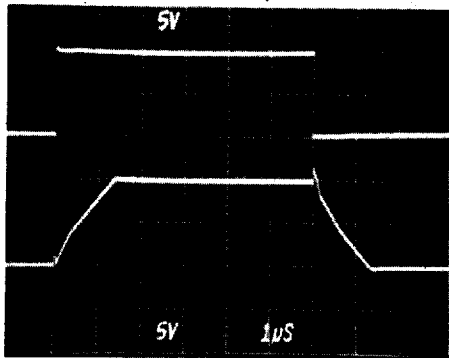
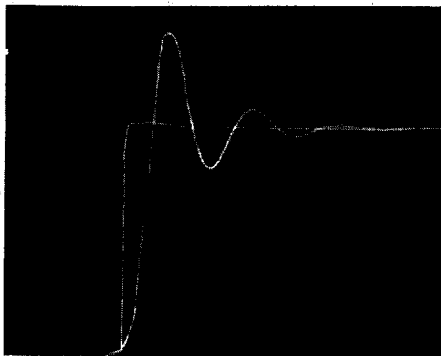

FIGURE 2. LARGE AND SMALL SIGNAL RESPONSE CIRCUIT

SMALL SIGNAL RESPONSE

Vertical Scale: 10mV/Div.
Horizontal Scale: 100ns/Div.



HA-5170 LOW FREQUENCY NOISE (0.1Hz TO 10Hz)

Vertical Scale: 200nV/Div. (Noise Referred to Input)
5mV/Div. at Output, $A_{vCL} = 25,000$.
Horizontal Scale: 1s/Div.

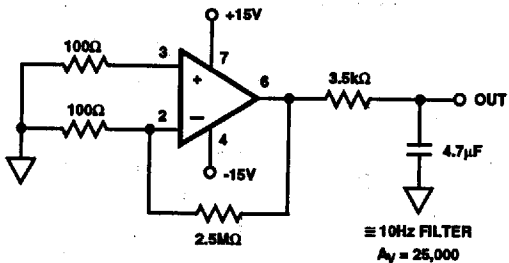
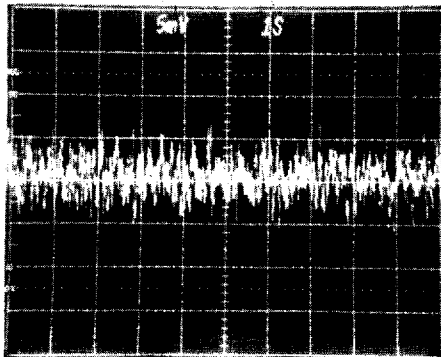

FIGURE 3. LOW FREQUENCY NOISE TEST CIRCUIT



Typical Performance Curves

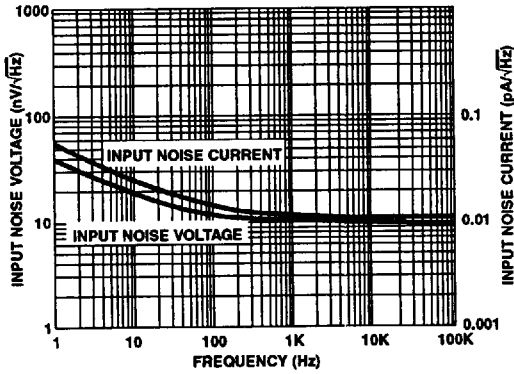

FIGURE 4. INPUT NOISE vs FREQUENCY

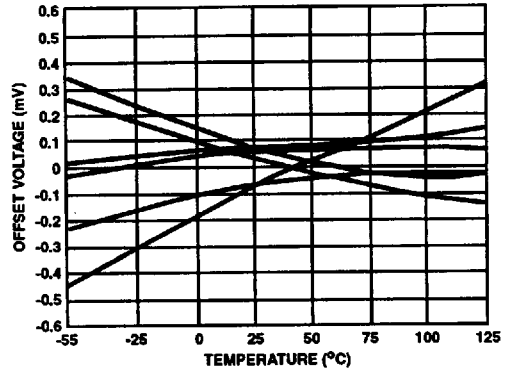

FIGURE 5. OFFSET VOLTAGE DRIFT vs TEMPERATURE OF REPRESENTATIVE UNITS

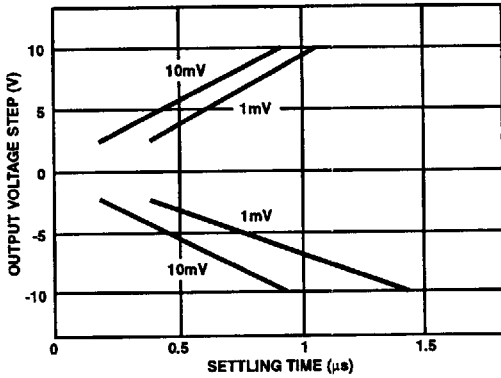

FIGURE 6. SETTLING TIME FOR VARIOUS OUTPUT STEP VOLTAGES

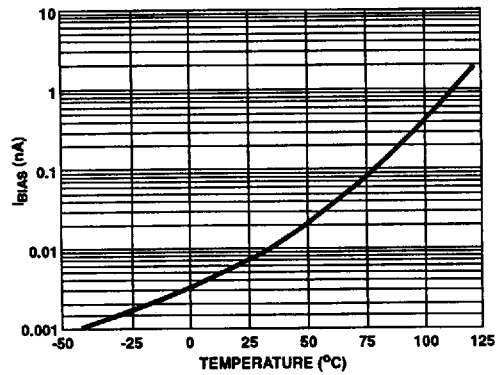

FIGURE 7. BIAS CURRENT vs TEMPERATURE

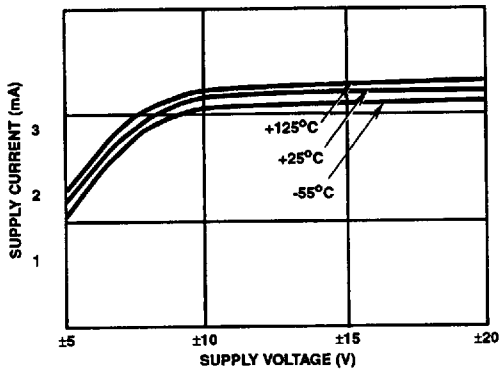

FIGURE 8. POWER SUPPLY CURRENT vs SUPPLY VOLTAGE AND TEMPERATURE

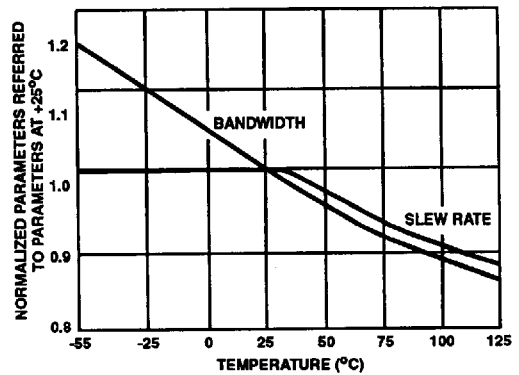

FIGURE 9. NORMALIZED AC PARAMETERS vs TEMPERATURE

2
OPERATIONAL
AMPLIFIERS

Typical Performance Curves (Continued)

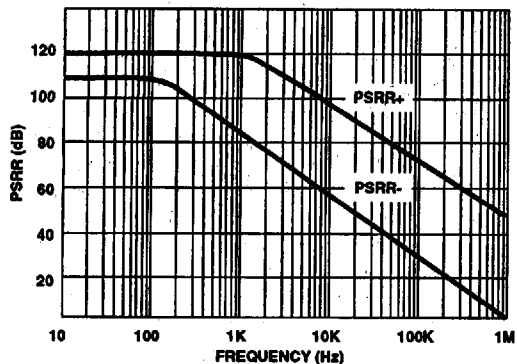

FIGURE 10. POWER SUPPLY REJECTION RATIO vs FREQUENCY

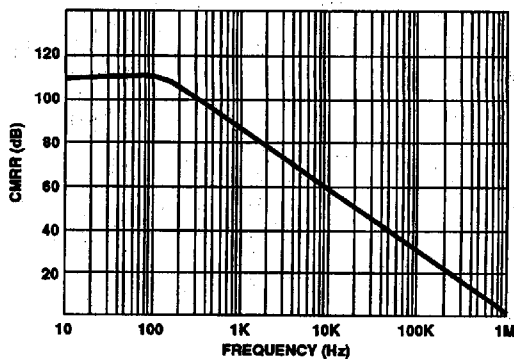

FIGURE 11. COMMON MODE REJECTION RATIO vs FREQUENCY

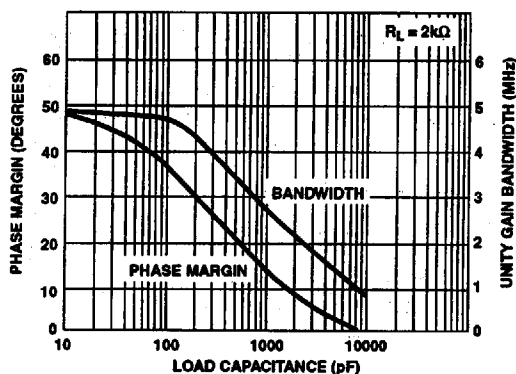

FIGURE 12. SMALL SIGNAL BANDWIDTH AND PHASE MARGIN vs LOAD CAPACITANCE

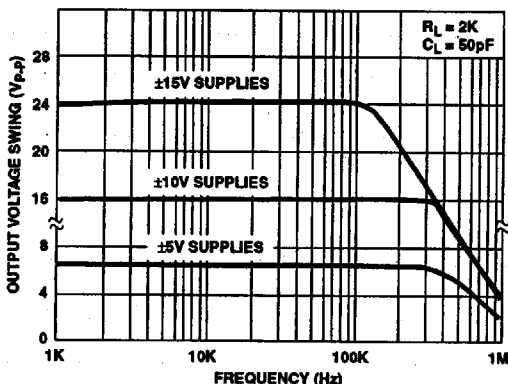

FIGURE 13. OUTPUT VOLTAGE SWING vs FREQUENCY AND SUPPLY VOLTAGE

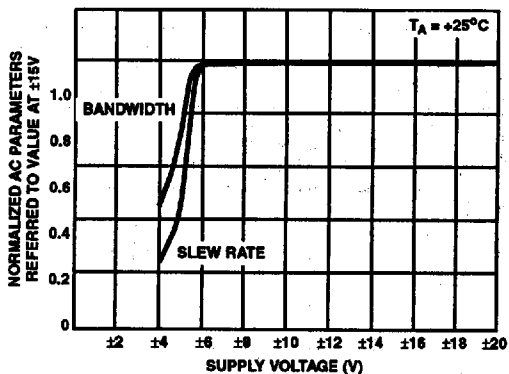

FIGURE 14. NORMALIZED AC PARAMETERS vs SUPPLY VOLTAGE

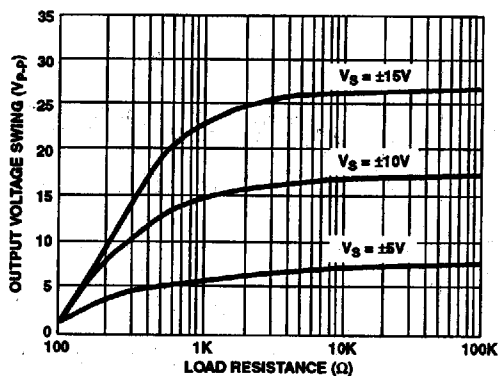

FIGURE 15. MAXIMUM OUTPUT VOLTAGE SWING vs LOAD RESISTANCE

Typical Performance Curves (Continued)

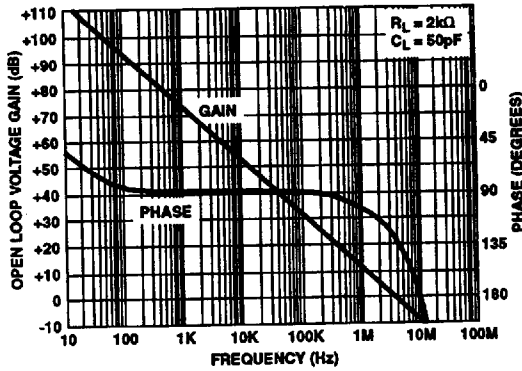

FIGURE 16. OPEN LOOP FREQUENCY RESPONSE

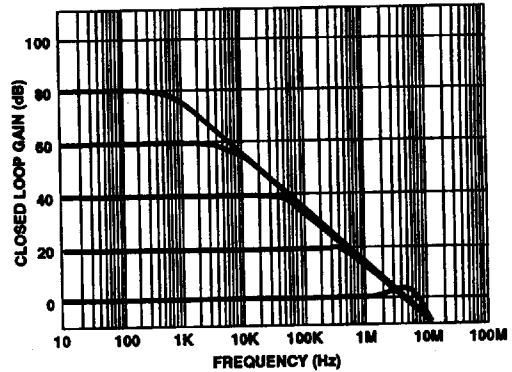

FIGURE 17. CLOSED LOOP FREQUENCY RESPONSE FOR VARIOUS CLOSED LOOP GAINS