

SD3421/5421

Silicon PIN Photodiode

FEATURES

- TO-46 metal can package
- Choice of flat window or lensed package
- 90° or 18° (nominal) acceptance angle option
- Fast response time
- Wide operating temperature range (-55°C to +125°C)
- Mechanically and spectrally matched to SE3450/5450, SE3455/5455 and SE3470/5470 infrared emitting diodes

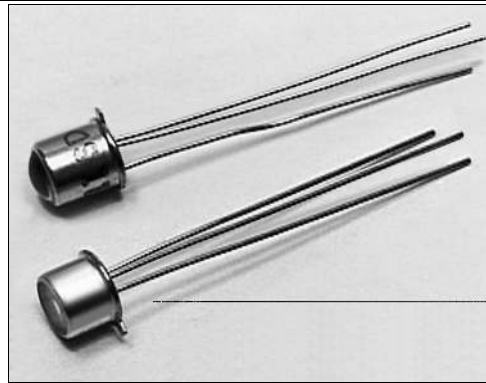

INFRA-57.TIF

DESCRIPTION

The SD3421/5421 series consists of PIN photodiodes mounted in a TO-46 metal can package. The SD3421 utilizes flat window cans providing a wide acceptance angle, while the SD5421 employs glass lensed cans providing a narrow acceptance angle. The TO-46 packages are ideally suited for operation in hostile environments.

OUTLINE DIMENSIONS in inches (mm)

Tolerance	3 plc decimals	±0.005(0.12)
	2 plc decimals	±0.020(0.51)

SD3421

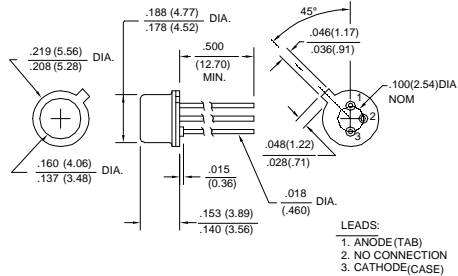

SD5421

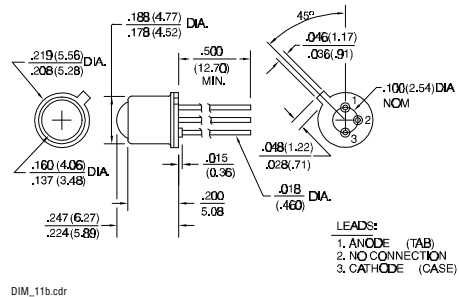

SD3421/5421

Silicon PIN Photodiode

ELECTRICAL CHARACTERISTICS (25°C unless otherwise noted)

PARAMETER	SYMBOL	MIN	TYP	MAX	UNITS	TEST CONDITIONS
Light Current SD3421-002 SD5421-002	I_L	10.0 40.0			μA	$V_R=20\text{ V}$ $H=5\text{ mW/cm}^2$ ⁽¹⁾
Dark Current	I_D			20	nA	$V_R=20\text{ V}$ $H=0$
Reverse Breakdown Voltage	V_{BR}	75			V	$I_R=10\ \mu\text{A}$
Angular Response ⁽²⁾ SD3421 SD5421	\emptyset		90 18		degr.	$I_F=\text{Constant}$
Rise And Fall Time	t_r, t_f		15		ns	$V_R=20\text{ V}$ $R_L=50\ \Omega$

Notes

- The radiation source is a tungsten lamp operating at a color temperature of 2870°K.
- Angular response is defined as the total included angle between the half sensitivity points.

ABSOLUTE MAXIMUM RATINGS

(25°C Free-Air Temperature unless otherwise noted)

Cathode Anode Voltage	75 V
Power Dissipation	150 mW ⁽¹⁾
Operating Temperature Range	-55°C to 125°C
Storage Temperature Range	-65°C to 150°C
Soldering Temperature (10 sec)	260°C

Notes

- Derate linearly from 25°C free-air temperature at the rate of 1.43 mW/°C.

SCHEMATIC

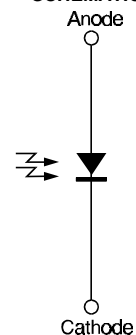

Honeywell reserves the right to make changes in order to improve design and supply the best products possible.

Honeywell

SD3421/5421

Silicon PIN Photodiode

SWITCHING TIME TEST CIRCUIT

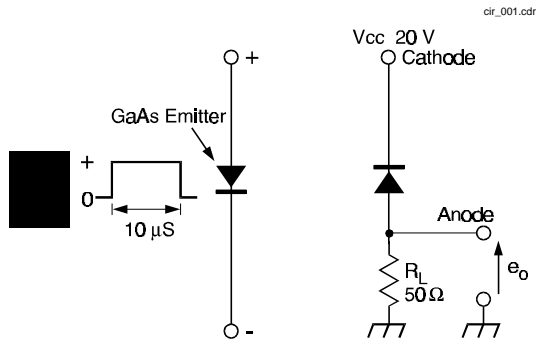
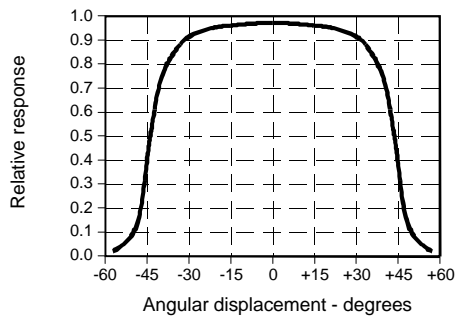

Fig. 1 Responsivity vs Angular Displacement (SD3421)



SWITCHING WAVEFORM

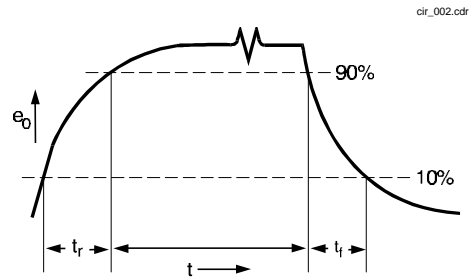

Fig. 2 Responsivity vs Angular Displacement (SD5421)

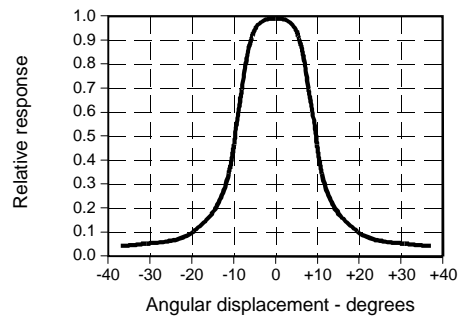

Fig. 3 Dark Current vs Temperature

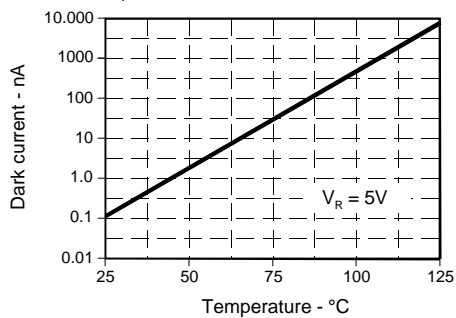
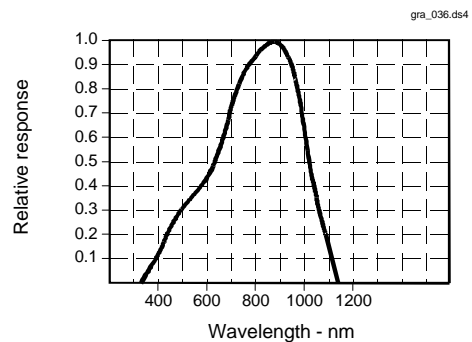

Fig. 4 Spectral Responsivity



All Performance Curves Show Typical Values

SD3421/5421
Silicon PIN Photodiode



Honeywell reserves the right to make changes in order to improve design and supply the best products possible.

Honeywell