



- SMD Common mode choke for power application
- Operating temperature range: -40°C to +120°C



Electrical Specifications @25°C								
OCL @10KHz/0.03V		DCR (mΩ) Max		Rated Current (A)	Insulation Resistance @ 500Vdc (MΩ Min)		HiPot VAC / 2mA / 3S	
(1 - 2)	(3 - 4)	(1 - 2)	(3 - 4)		Pri-Sec	Pri,Sec-Core	Coil-Coil	Coil-Core
470μH±35%	470μH±35%	8.0	8.0	14.0	100	100	1000	500

All specifications subject to change without notice.

MECHANICAL

Dimensions: $\frac{\text{inch}}{\text{mm}}$

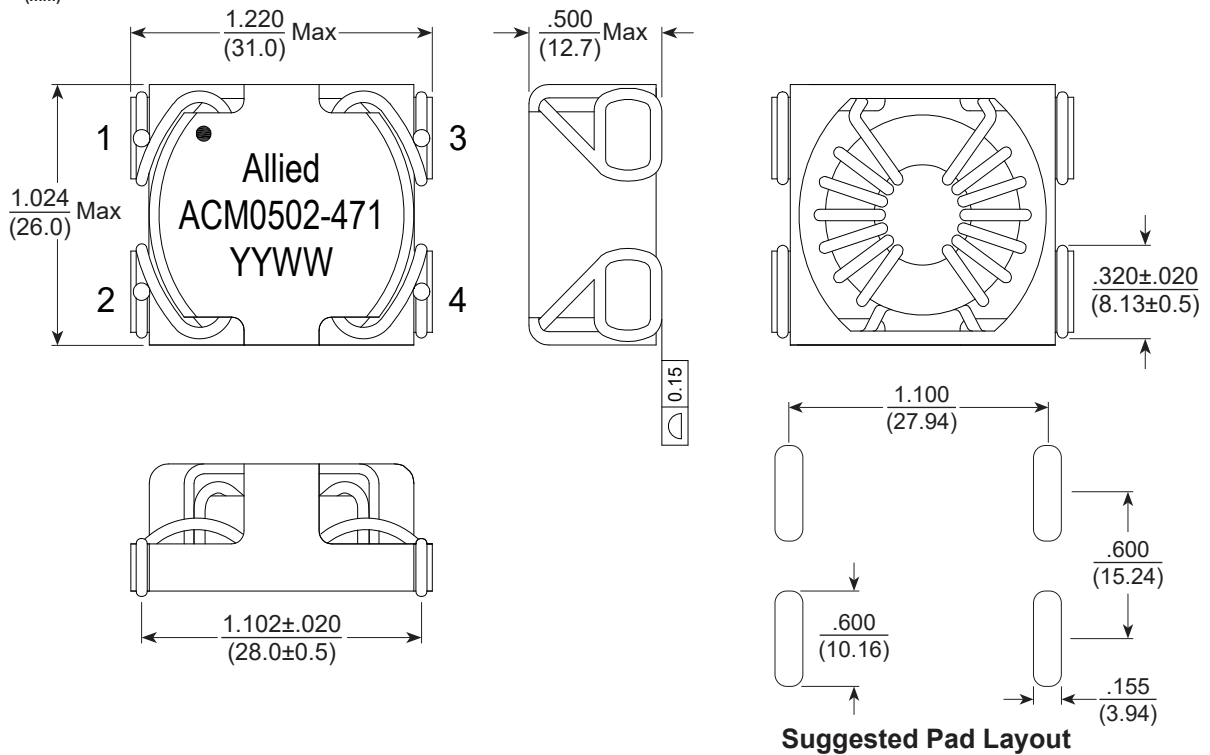

SCHEMATIC

