

PTVSxS1UR series

400 W Transient Voltage Suppressor

Rev. 3 — 10 January 2011

Product data sheet

1. Product profile

1.1 General description

400 W unidirectional Transient Voltage Suppressor (TVS) in a SOD123W small and flat lead low-profile Surface-Mounted Device (SMD) plastic package, designed for transient overvoltage protection.

1.2 Features and benefits

- Rated peak pulse power:
 $P_{PPM} = 400\text{ W}$ (350 W for 3V3)
- Reverse standoff voltage range:
 $V_{RWM} = 3.3\text{ V}$ to 64 V
- Reverse current: $I_{RM} = 0.001\text{ }\mu\text{A}$
- Small plastic package suitable for surface-mounted design
- Very low package height: 1 mm
- AEC-Q101 qualified

1.3 Applications

- Power supply protection
- Automotive application
- Industrial application
- Power management

1.4 Quick reference data

Table 1. Quick reference data

Symbol	Parameter	Conditions	Min	Typ	Max	Unit
P_{PPM}	rated peak pulse power		[1][2]	-	400	W
V_{RWM}	reverse standoff voltage		3.3	-	64	V



[1] In accordance with IEC 61643-321 (10/1000 μs current waveform).

[2] For PTVS3V3S1UR: $P_{PPM} = 350\text{ W}$

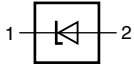

2. Pinning information

Table 2. Pinning

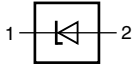
Pin	Description	Simplified outline	Graphic symbol
1	cathode	[1]	
2	anode		 006aaa152

[1] The marking bar indicates the cathode.

3. Ordering information

Table 3. Ordering information

Type number[1]	Package		
	Name	Description	Version
PTVSxS1UR series	-	plastic surface-mounted package; 2 leads	SOD123W

[1] The series consists of 35 types with reverse standoff voltages from 3.3 V to 64 V.

4. Marking

Table 4. Marking codes

Type number	Marking code	Type number	Marking code
PTVS3V3S1UR	A1	PTVS20VS1UR	AL
PTVS5V0S1UR	A2	PTVS22VS1UR	AM
PTVS6V0S1UR	A3	PTVS24VS1UR	AN
PTVS6V5S1UR	A4	PTVS26VS1UR	AP
PTVS7V0S1UR	A5	PTVS28VS1UR	AR
PTVS7V5S1UR	A6	PTVS30VS1UR	AS
PTVS8V0S1UR	A7	PTVS33VS1UR	AT
PTVS8V5S1UR	A8	PTVS36VS1UR	AU
PTVS9V0S1UR	A9	PTVS40VS1UR	AV
PTVS10VS1UR	AA	PTVS43VS1UR	AW
PTVS11VS1UR	AB	PTVS45VS1UR	AX
PTVS12VS1UR	AC	PTVS48VS1UR	AY
PTVS13VS1UR	AD	PTVS51VS1UR	AZ
PTVS14VS1UR	AE	PTVS54VS1UR	B1
PTVS15VS1UR	AF	PTVS58VS1UR	B2
PTVS16VS1UR	AG	PTVS60VS1UR	B3
PTVS17VS1UR	AH	PTVS64VS1UR	B4
PTVS18VS1UR	AK	-	-

5. Limiting values

Table 5. Limiting values

In accordance with the Absolute Maximum Rating System (IEC 60134).

Symbol	Parameter	Conditions	Min	Max	Unit
P_{PPM}	rated peak pulse power		[1][2] -	400	W
I_{PPM}	rated peak pulse current		[1] -	see Table 9 and 10	
I_{FSM}	Non-repetitive peak forward current	single half-sine wave; $t_p = 8.3$ ms	-	50	A
T_j	junction temperature		-	150	°C
T_{amb}	ambient temperature		-55	+150	°C
T_{stg}	storage temperature		-65	+150	°C

[1] In accordance with IEC 61643-321 (10/1000 μ s current waveform).

[2] For PTVS3V3S1UR: $P_{PPM} = 350$ W

Table 6. ESD maximum ratings

$T_{amb} = 25$ °C unless otherwise specified.

Symbol	Parameter	Conditions	Min	Max	Unit
Per diode					
V_{ESD}	electrostatic discharge voltage	IEC 61000-4-2 (contact discharge)	[1][2] -	30	kV

[1] Device stressed with ten non-repetitive ElectroStatic Discharge (ESD) pulses.

[2] Soldering point of cathode tab.

Table 7. ESD standards compliance

Standard	Conditions
Per diode	
IEC 61000-4-2; level 4 (ESD)	> 15 kV (air); > 8 kV (contact)
MIL-STD-883; class 3 (human body model)	> 4 kV

6. Thermal characteristics

Table 8. Thermal characteristics

Symbol	Parameter	Conditions	Min	Typ	Max	Unit	
$R_{th(j-a)}$	thermal resistance from junction to ambient	in free air	[1]	-	-	220	K/W
			[2]	-	-	130	K/W
			[3]	-	-	70	K/W
$R_{th(j-sp)}$	thermal resistance from junction to solder point		[4]	-	-	18	K/W

- [1] Device mounted on an FR4 Printed-Circuit Board (PCB), single-sided copper, tin-plated and standard footprint.
- [2] Device mounted on an FR4 PCB, single-sided copper, tin-plated, mounting pad for cathode 1 cm².
- [3] Device mounted on a ceramic PCB, Al₂O₃, standard footprint.
- [4] Soldering point of cathode tab.

7. Characteristics

Table 9. Characteristics per type; PTVS3V3S1UR to PTVS7V0S1UR

$T_j = 25\text{ °C}$ unless otherwise specified.

Type number	Reverse standoff voltage V_{RWM} (V)	Breakdown voltage V_{BR} (V)			Reverse leakage current I_{RM} (μA)		Clamping voltage V_{CL} (V)	
		$I_R = 10\text{ mA}$			at V_{RWM} (V)		Max	I_{PPM} (A)
	Max	Min	Typ	Max	Typ	Max		
PTVS3V3S1UR	3.3	5.20	5.60	6.00	5	600	8.0	43.8
PTVS5V0S1UR	5.0	6.40	6.70	7.00	5	400	9.2	43.5
PTVS6V0S1UR	6.0	6.67	7.02	7.37	5	400	10.3	38.8
PTVS6V5S1UR	6.5	7.22	7.60	7.98	5	250	11.2	35.7
PTVS7V0S1UR	7.0	7.78	8.20	8.60	3	100	12.0	33.3

Table 10. Characteristics per type; PTVS7V5S1UR to PTVS64VS1UR

$T_j = 25\text{ °C}$ unless otherwise specified.

Type number	Reverse standoff voltage V_{RWM} (V)	Breakdown voltage V_{BR} (V)			Reverse leakage current I_{RM} (μA)		Clamping voltage V_{CL} (V)	
		$I_R = 1\text{ mA}$			at V_{RWM} (V)		Max	I_{PPM} (A)
	Max	Min	Typ	Max	Typ	Max		
PTVS7V5S1UR	7.5	8.33	8.77	9.21	0.2	50	12.9	31.0
PTVS8V0S1UR	8.0	8.89	9.36	9.83	0.03	25	13.6	29.4
PTVS8V5S1UR	8.5	9.44	9.92	10.40	0.01	10	14.4	27.8
PTVS9V0S1UR	9.0	10.00	10.55	11.10	0.005	5	15.4	26.0
PTVS10VS1UR	10	11.10	11.70	12.30	0.005	2.5	17.0	23.5
PTVS11VS1UR	11	12.20	12.85	13.50	0.005	2.5	18.2	22.0
PTVS12VS1UR	12	13.30	14.00	14.70	0.005	2.5	19.9	20.1
PTVS13VS1UR	13	14.40	15.15	15.90	0.001	0.1	21.5	18.6

Table 10. Characteristics per type; PTVS7V5S1UR to PTVS64VS1UR ...continued

 $T_j = 25\text{ }^\circ\text{C}$ unless otherwise specified.

Type number	Reverse standoff voltage V_{RWM} (V)	Breakdown voltage V_{BR} (V)			Reverse leakage current I_{RM} (μA)		Clamping voltage V_{CL} (V)	
		$I_R = 1\text{ mA}$			at V_{RWM} (V)		Max	I_{PPM} (A)
	Max	Min	Typ	Max	Typ	Max		
PTVS14VS1UR	14	15.60	16.40	17.20	0.001	0.1	23.2	17.2
PTVS15VS1UR	15	16.70	17.60	18.50	0.001	0.1	24.4	16.4
PTVS16VS1UR	16	17.80	18.75	19.70	0.001	0.1	26.0	15.4
PTVS17VS1UR	17	18.90	19.90	20.90	0.001	0.1	27.6	14.5
PTVS18VS1UR	18	20.00	21.00	22.10	0.001	0.1	29.2	13.7
PTVS20VS1UR	20	22.20	23.35	24.50	0.001	0.1	32.4	12.3
PTVS22VS1UR	22	24.40	25.60	26.90	0.001	0.1	35.5	11.3
PTVS24VS1UR	24	26.70	28.10	29.50	0.001	0.1	38.9	10.3
PTVS26VS1UR	26	28.90	30.40	31.90	0.001	0.1	42.1	9.5
PTVS28VS1UR	28	31.10	32.80	34.40	0.001	0.1	45.4	8.8
PTVS30VS1UR	30	33.30	35.10	36.80	0.001	0.1	48.4	8.3
PTVS33VS1UR	33	36.70	38.70	40.60	0.001	0.1	53.3	7.5
PTVS36VS1UR	36	40.00	42.10	44.20	0.001	0.1	58.1	6.9
PTVS40VS1UR	40	44.40	46.80	49.10	0.001	0.1	64.5	6.2
PTVS43VS1UR	43	47.80	50.30	52.80	0.001	0.1	69.4	5.8
PTVS45VS1UR	45	50.00	52.65	55.30	0.001	0.1	72.7	5.5
PTVS48VS1UR	48	53.30	56.10	58.90	0.001	0.1	77.4	5.2
PTVS51VS1UR	51	56.70	59.70	62.70	0.001	0.1	82.4	4.9
PTVS54VS1UR	54	60.00	63.15	66.30	0.001	0.1	87.1	4.6
PTVS58VS1UR	58	64.40	67.80	71.20	0.001	0.1	93.6	4.3
PTVS60VS1UR	60	66.70	70.20	73.70	0.001	0.1	96.8	4.1
PTVS64VS1UR	64	71.10	74.85	78.60	0.001	0.1	103.0	3.9

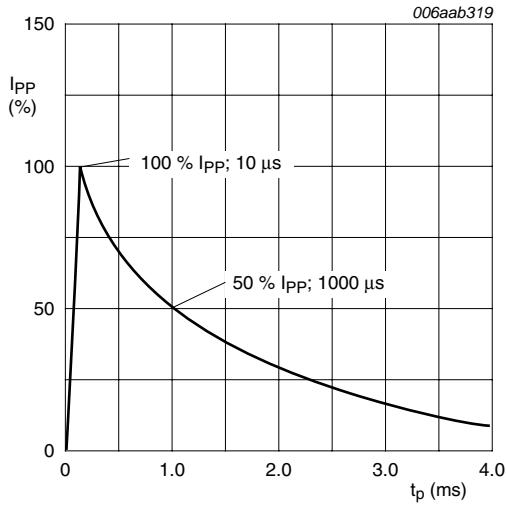

Fig 1. 10/1000 μ s pulse waveform according to IEC 61643-321

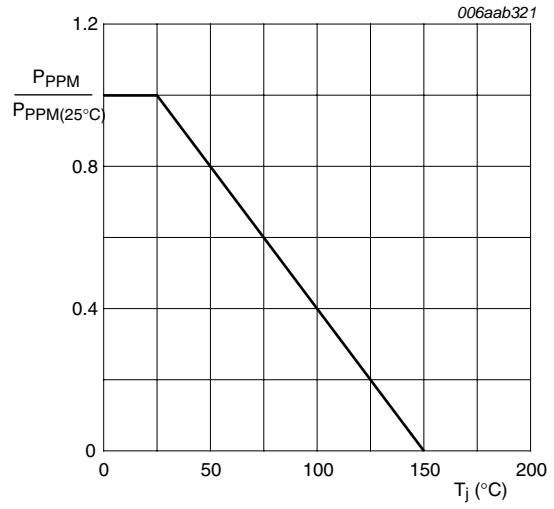
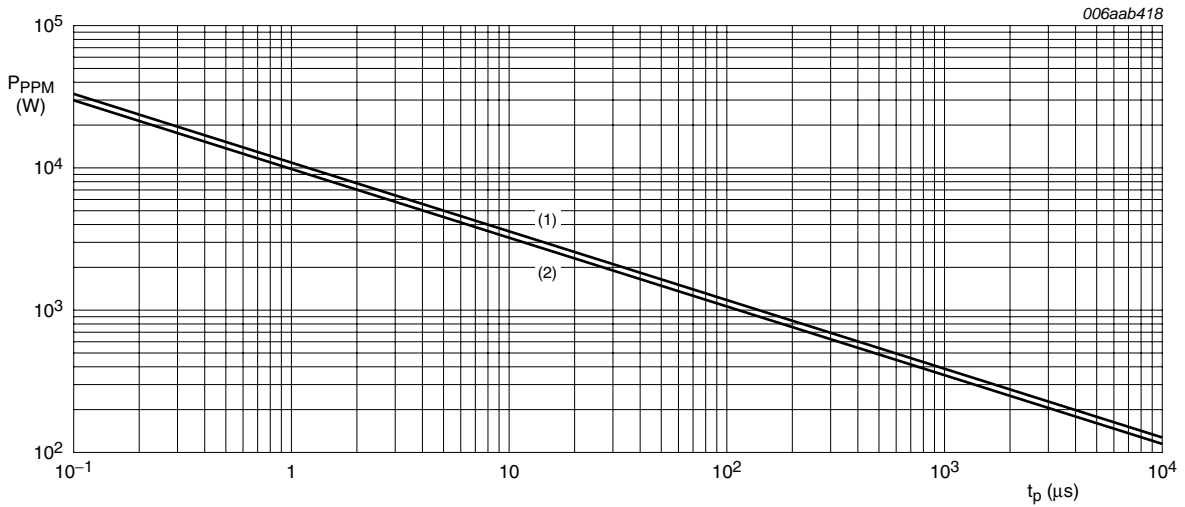

Fig 2. Relative variation of rated peak pulse power as a function of junction temperature; typical values



$T_{amb} = 25^\circ\text{C}$

- (1) PTVS5V0S1UR to PTVS64VS1UR
- (2) PTVS3V3S1UR

Fig 3. Rated peak pulse power as a function of pulse duration; typical values

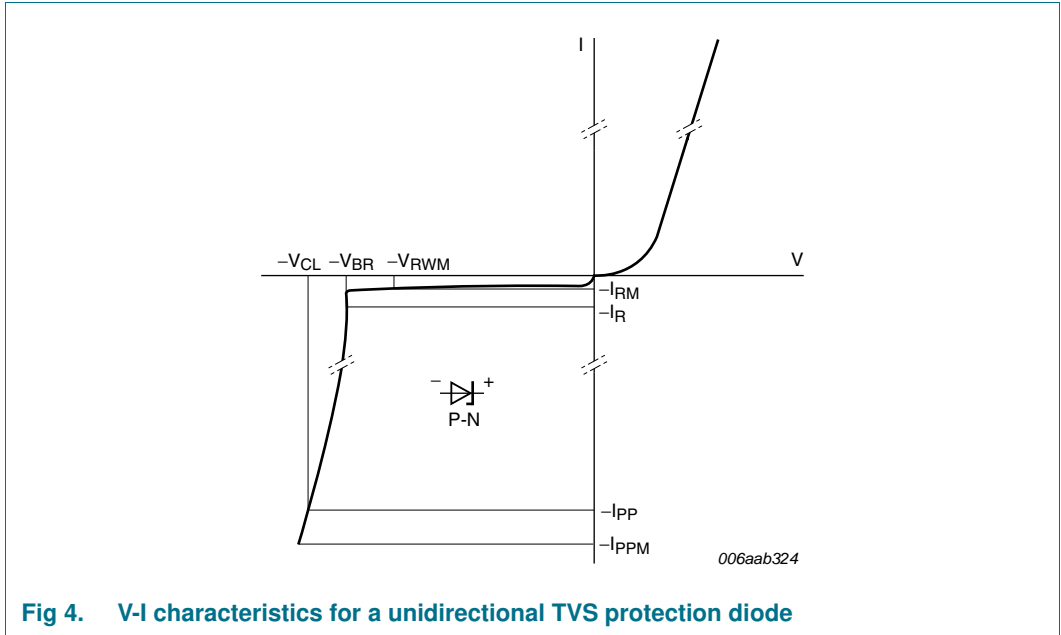

Fig 4. V-I characteristics for a unidirectional TVS protection diode

8. Test information

8.1 Quality information

This product has been qualified in accordance with the Automotive Electronics Council (AEC) standard Q101 - Stress test qualification for discrete semiconductors, and is suitable for use in automotive applications.

9. Package outline

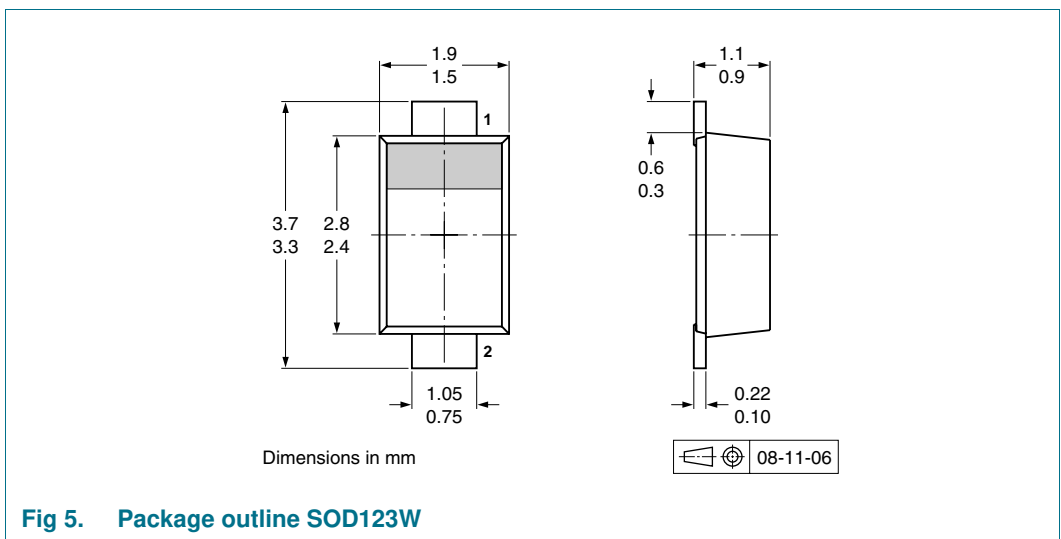

Fig 5. Package outline SOD123W

10. Packing information

Table 11. Packing methods

The indicated -xxx are the last three digits of the 12NC ordering code.^[1]

Type number ^[2]	Package	Description	Packing quantity
			3000
PTVSxS1UR series	SOD123W	4 mm pitch, 8 mm tape and reel	-115

[1] For further information and the availability of packing methods, see [Section 14](#).

[2] The series consists of 35 types with reverse standoff voltages from 3.3 V to 64 V.

11. Soldering

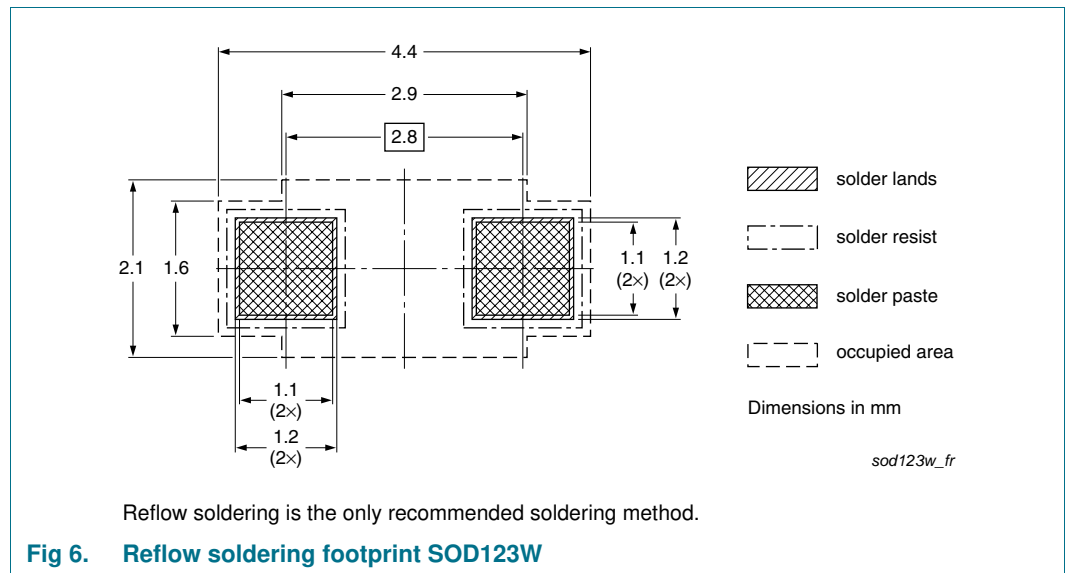

12. Revision history

Table 12. Revision history

Document ID	Release date	Data sheet status	Change notice	Supersedes
PTVSXS1UR_SER v.3	20110110	Product data sheet	-	PTVSXS1UR_SER v.2
Modifications:	<ul style="list-style-type: none">• Table 6 and 7: added.• Section 13 "Legal information": updated.			
PTVSXS1UR_SER v.2	20090910	Product data sheet	-	PTVSXS1UR_SER v.1
PTVSXS1UR_SER v.1	20090202	Product data sheet	-	-

13. Legal information

13.1 Data sheet status

Document status ^{[1][2]}	Product status ^[3]	Definition
Objective [short] data sheet	Development	This document contains data from the objective specification for product development.
Preliminary [short] data sheet	Qualification	This document contains data from the preliminary specification.
Product [short] data sheet	Production	This document contains the product specification.

[1] Please consult the most recently issued document before initiating or completing a design.

[2] The term 'short data sheet' is explained in section "Definitions".

[3] The product status of device(s) described in this document may have changed since this document was published and may differ in case of multiple devices. The latest product status information is available on the Internet at URL <http://www.nxp.com>.

13.2 Definitions

Draft — The document is a draft version only. The content is still under internal review and subject to formal approval, which may result in modifications or additions. NXP Semiconductors does not give any representations or warranties as to the accuracy or completeness of information included herein and shall have no liability for the consequences of use of such information.

Short data sheet — A short data sheet is an extract from a full data sheet with the same product type number(s) and title. A short data sheet is intended for quick reference only and should not be relied upon to contain detailed and full information. For detailed and full information see the relevant full data sheet, which is available on request via the local NXP Semiconductors sales office. In case of any inconsistency or conflict with the short data sheet, the full data sheet shall prevail.

Product specification — The information and data provided in a Product data sheet shall define the specification of the product as agreed between NXP Semiconductors and its customer, unless NXP Semiconductors and customer have explicitly agreed otherwise in writing. In no event however, shall an agreement be valid in which the NXP Semiconductors product is deemed to offer functions and qualities beyond those described in the Product data sheet.

13.3 Disclaimers

Limited warranty and liability — Information in this document is believed to be accurate and reliable. However, NXP Semiconductors does not give any representations or warranties, expressed or implied, as to the accuracy or completeness of such information and shall have no liability for the consequences of use of such information.

In no event shall NXP Semiconductors be liable for any indirect, incidental, punitive, special or consequential damages (including - without limitation - lost profits, lost savings, business interruption, costs related to the removal or replacement of any products or rework charges) whether or not such damages are based on tort (including negligence), warranty, breach of contract or any other legal theory.

Notwithstanding any damages that customer might incur for any reason whatsoever, NXP Semiconductors' aggregate and cumulative liability towards customer for the products described herein shall be limited in accordance with the *Terms and conditions of commercial sale* of NXP Semiconductors.

Right to make changes — NXP Semiconductors reserves the right to make changes to information published in this document, including without limitation specifications and product descriptions, at any time and without notice. This document supersedes and replaces all information supplied prior to the publication hereof.

Suitability for use — NXP Semiconductors products are not designed, authorized or warranted to be suitable for use in life support, life-critical or safety-critical systems or equipment, nor in applications where failure or

malfunction of an NXP Semiconductors product can reasonably be expected to result in personal injury, death or severe property or environmental damage. NXP Semiconductors accepts no liability for inclusion and/or use of NXP Semiconductors products in such equipment or applications and therefore such inclusion and/or use is at the customer's own risk.

Applications — Applications that are described herein for any of these products are for illustrative purposes only. NXP Semiconductors makes no representation or warranty that such applications will be suitable for the specified use without further testing or modification.

Customers are responsible for the design and operation of their applications and products using NXP Semiconductors products, and NXP Semiconductors accepts no liability for any assistance with applications or customer product design. It is customer's sole responsibility to determine whether the NXP Semiconductors product is suitable and fit for the customer's applications and products planned, as well as for the planned application and use of customer's third party customer(s). Customers should provide appropriate design and operating safeguards to minimize the risks associated with their applications and products.

NXP Semiconductors does not accept any liability related to any default, damage, costs or problem which is based on any weakness or default in the customer's applications or products, or the application or use by customer's third party customer(s). Customer is responsible for doing all necessary testing for the customer's applications and products using NXP Semiconductors products in order to avoid a default of the applications and the products or of the application or use by customer's third party customer(s). NXP does not accept any liability in this respect.

Limiting values — Stress above one or more limiting values (as defined in the Absolute Maximum Ratings System of IEC 60134) will cause permanent damage to the device. Limiting values are stress ratings only and (proper) operation of the device at these or any other conditions above those given in the Recommended operating conditions section (if present) or the Characteristics sections of this document is not warranted. Constant or repeated exposure to limiting values will permanently and irreversibly affect the quality and reliability of the device.

Terms and conditions of commercial sale — NXP Semiconductors products are sold subject to the general terms and conditions of commercial sale, as published at <http://www.nxp.com/profile/terms>, unless otherwise agreed in a valid written individual agreement. In case an individual agreement is concluded only the terms and conditions of the respective agreement shall apply. NXP Semiconductors hereby expressly objects to applying the customer's general terms and conditions with regard to the purchase of NXP Semiconductors products by customer.

No offer to sell or license — Nothing in this document may be interpreted or construed as an offer to sell products that is open for acceptance or the grant, conveyance or implication of any license under any copyrights, patents or other industrial or intellectual property rights.

Export control — This document as well as the item(s) described herein may be subject to export control regulations. Export might require a prior authorization from national authorities.

Quick reference data — The Quick reference data is an extract of the product data given in the Limiting values and Characteristics sections of this document, and as such is not complete, exhaustive or legally binding.

13.4 Trademarks

Notice: All referenced brands, product names, service names and trademarks are the property of their respective owners.

14. Contact information

For more information, please visit: <http://www.nxp.com>

For sales office addresses, please send an email to: salesaddresses@nxp.com

15. Contents

1 Product profile 1

1.1 General description 1

1.2 Features and benefits 1

1.3 Applications 1

1.4 Quick reference data 1

2 Pinning information 2

3 Ordering information 2

4 Marking 2

5 Limiting values 3

6 Thermal characteristics 4

7 Characteristics 4

8 Test information 7

8.1 Quality information 7

9 Package outline 7

10 Packing information 8

11 Soldering 8

12 Revision history 9

13 Legal information 10

13.1 Data sheet status 10

13.2 Definitions 10

13.3 Disclaimers 10

13.4 Trademarks 11

14 Contact information 11

15 Contents 12

Please be aware that important notices concerning this document and the product(s) described herein, have been included in section 'Legal information'.

© NXP B.V. 2011. All rights reserved.

For more information, please visit: <http://www.nxp.com>
 For sales office addresses, please send an email to: salesaddresses@nxp.com

Date of release: 10 January 2011
 Document identifier: PTVSxS1UR_SER