



LOW PROFILE IOT ANTENNA

FOR VEHICLE MOUNTING

This antenna is designed to decrease the lifetime cost of M2M and IoT applications by offering a robust low profile antenna for challenging environments.

The antenna covers 698-960/1710-3800 MHz supporting 3G, 4G and 3.5GHz 5G , optional 2.4/5.0GHz Wi-Fi and optional GPS/GNSS with a 26dB LNA. The efficient design ensures a high first time correction rate and an ongoing, robust communication link even in many low coverage areas.

The antenna can be installed on conductive or non-conductive panels via the 19mm (3/4") mounting bush and is fitted with Flame retardant RG174 cables compliant with UN ECE R118 and either Fakra or SMA connectors.

Technical Drawing

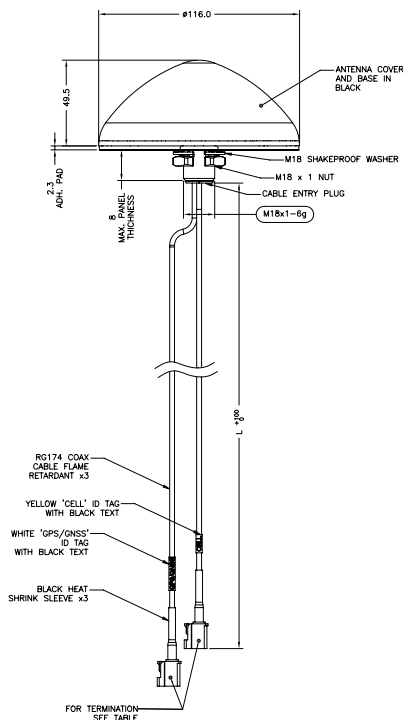

Partnumber	Cell	WLAN	GNSS	Length	Connector
2370914-1	Y	Y	Y	3m	SMA
2370914-2	Y	Y	Y	3m	Fakra
2370914-3	Y	Y	Y	1m	Fakra
2370914-4	Y	Y	Y	1m	SMA
1-2370914-1	Y	N	Y	3m	SMA
1-2370914-2	Y	N	Y	3m	Fakra
1-2370914-3	Y	N	Y	1m	Fakra
1-2370914-4	Y	N	Y	1m	SMA
2-2370914-1	Y	N	N	3m	SMA
2-2370914-2	Y	N	N	3m	Fakra
2-2370914-3	Y	N	N	1m	Fakra
2-1234567-4	Y	N	N	1m	SMA

LOW PROFILE IOT ANTENNA

FOR VEHICLE MOUNTING

Electrical Data		2370914-1	2370914-2	2370914-3	2370914-4
Frequency Range (MHz)	Element 1	698-960/1710-3800MHz			
	Element 2	2400-2485/4900-6000MHz			
	Element 3	1562-1612			
Operational Band		2G/3G/ 3.5GHz 5G, GPS/GNSS, Wi-Fi			
Radiation pattern		Omni-Directional			
Nominal Polarisation		Vertical			
Peak Gain (excl cable loss)	698-960 MHz	1dBi			
	1710-3800 MHz	6dBi			
	2.4GHz	7dBi			
	5.0GHz	7dBi			
Typical VSWR		<2.5:1			
Impedance		50Ω			
Max input power (W)		20W			
GPS/GNSS data					
Frequency Range (MHz)		1562-1612 MHz			
LNA Gain (dB)		26dB			
Operating Voltage		3-5VDC (Fed via Coax)			
Typical Current		15mA			
Mechanical Data					
Dimensions (mm)	Height (mm)	49.5 (1.94")			
	Diameter (mm)	116 (4.56")			
Operating Temp (°C)		-40 to +85°C (-40 to 185°F)			
Material		Lexan EXL 9330 (UL94V-0)			
Colour		Black			
Weight (g)		TBD		TBD	
Ingress Protection		IK10, IP69K			
Mounting Data					
Fixing		Panel mount 19mm (3/4")			
Cable Data					
Cable type Cellular/WiFi/GNSS		RG174 (meets UN ECE 118)			
Diameter (mm)		2.8 (0.11")			
Length (m)		3 (10')		1 (3' 3")	
Termination Cellular		SMA (m)	Fakra D (Burgundy) Jack	Fakra D (Burgundy) Jack	SMA (m)
Termination Termination WiFi		SMA rev Pol	Fakra I (beige) Jack	Fakra I (Beige) Jack	SMA rev Pol
Termination GPS/GNSS		SMA (m)	Fakra C (Blue) Jack	Fakra C (Blue) Jack	SMA (m)

LOW PROFILE IOT ANTENNA

FOR VEHICLE MOUNTING

Electrical Data		1-2370914-1	1-2370914-2	1-2370914-3	1-2370914-4
Frequency Range (MHz)	Element 1	698-960/1710-3800MHz			
	Element 3	1562-1612			
Operational Band		2G/3G/ 3.5GHz 5G, GPS/GNSS			
Radiation pattern		Omni-Directional			
Nominal Polarisation		Vertical			
Peak Gain (excl cable loss)	698-960 MHz	1dBi			
	1710-3800 MHz	6dBi			
Typical VSWR		<2.5:1			
Impedance		50Ω			
Max input power (W)		20W			
GPS/GNSS data					
Frequency Range (MHz)		1562-1612 MHz			
LNA Gain (dB)		26dB			
Operating Voltage		3-5VDC (Fed via Coax)			
Typical Current		15mA			
Mechanical Data					
Dimensions (mm)	Height (mm)	49.5 (1.94")			
	Diameter (mm)	116 (4.56")			
Operating Temp (°C)		-40 to +85°C (-40 to 185°F)			
Material		Lexan EXL 9330 (UL94V-0)			
Colour		Black			
Weight (g)		TBD		TBD	
Ingress Protection		IK10, IP69K			
Mounting Data					
Fixing		Panel mount 19mm (3/4")			
Cable Data					
Cable type Cellular/GNSS		RG174 (meets UN ECE 118)			
Diameter (mm)		2.8 (0.11")			
Length (m)		3 (10')		1 (3' 3")	
Termination Cellular		SMA (m)	Fakra D (Burgundy) Jack	Fakra D (Burgundy) Jack	SMA (m)
Termination GNSS		SMA (m)	Fakra C (Blue) Jack	Fakra C (Blue) Jack	SMA (m)

LOW PROFILE IOT ANTENNA

FOR VEHICLE MOUNTING

Electrical Data		2-2370914-1	2-2370914-2	2-2370914-3	2-2370914-4
Frequency Range (MHz)	Element 1	698-960/1710-3800MHz			
Operational Band		2G/3G/ 3.5GHz 5G			
Radiation pattern		Omni-Directional			
Nominal Polarisation		Vertical			
Peak Gain (excl cable loss)	698-960 MHz	1dBi			
	1710-3800 MHz	6dBi			
Typical VSWR		<2.5:1			
Impedance		50Ω			
Max input power (W)		20W			
Mechanical Data					
Dimensions (mm)	Height (mm)	49.5 (1.94")			
	Diameter (mm)	116 (4.56")			
Operating Temp (°C)		-40 to +85°C (-40 to 185°F)			
Material		Lexan EXL 9330 (UL94V-0)			
Colour		Black			
Weight (g)		TBD		TBD	
Ingress Protection		IK10, IP69K			
Mounting Data					
Fixing		Panel mount 19mm (3/4")			
Cable Data					
Cable type Cellular		RG174 (meets UN ECE 118)			
Diameter (mm)		2.8 (0.11")			
Length (m)		3 (10')		1 (3' 3")	
Termination Cellular		SMA (m)	Fakra D (Burgundy) Jack	Fakra D (Burgundy) Jack	SMA (m)

typical VSWR - Element 1

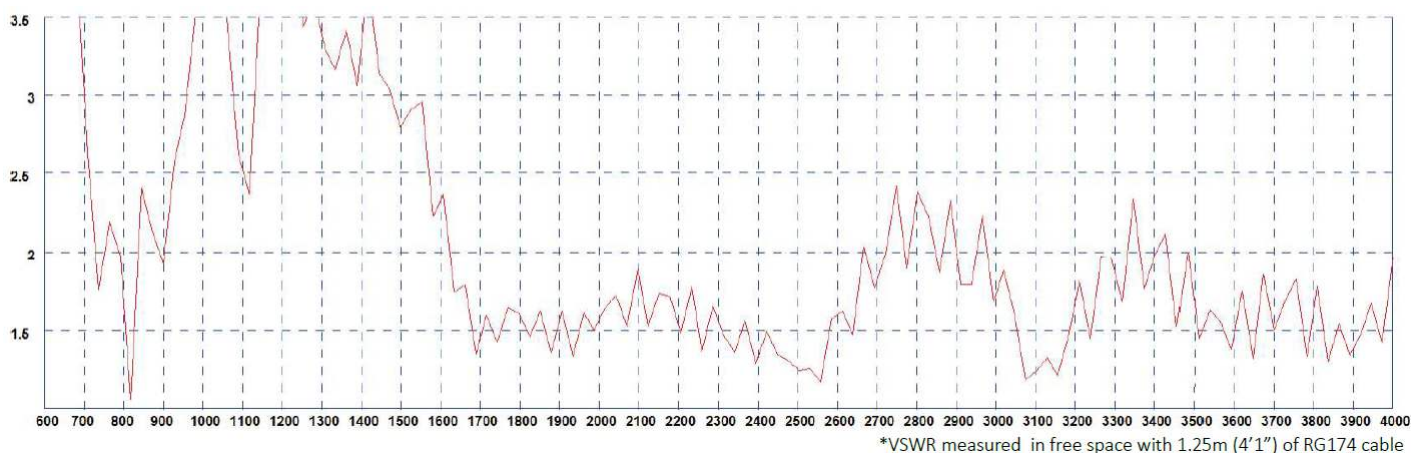

LOW PROFILE IOT ANTENNA FOR VEHICLE MOUNTING

typical VSWR - Element 2

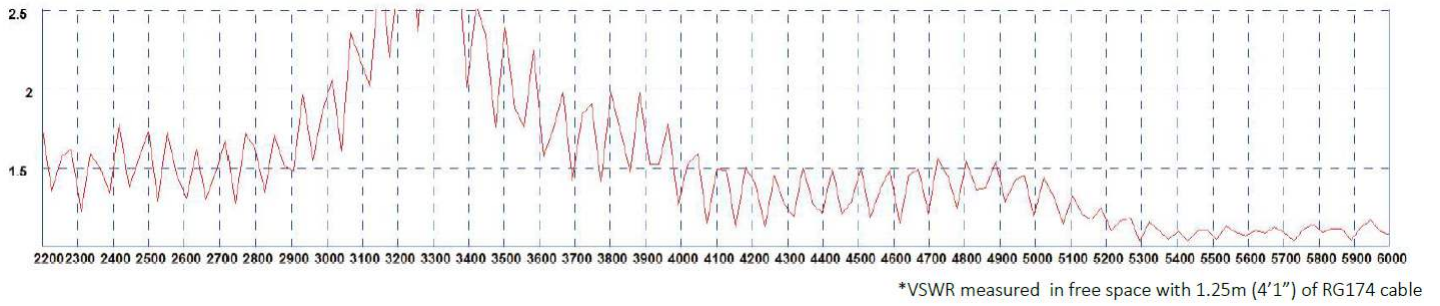

3D Patterns - Element 1

Typical 3D Pattern Side -700MHz

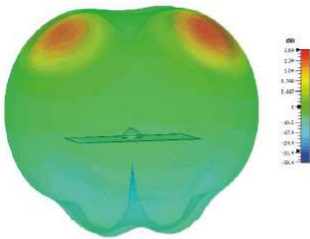

Typical 3D Pattern Side -800MHz

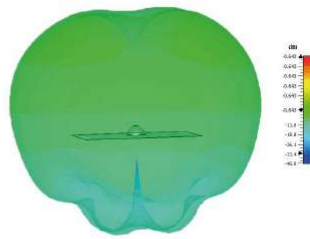

Typical 3D Pattern Side -900MHz

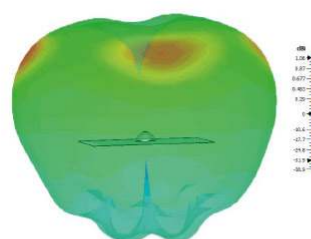

Typical 3D Pattern Side -1800MHz

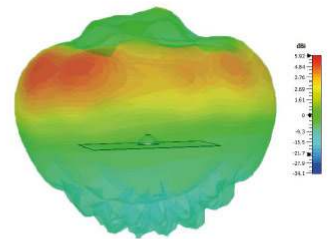

Typical 3D Pattern Side -2100MHz

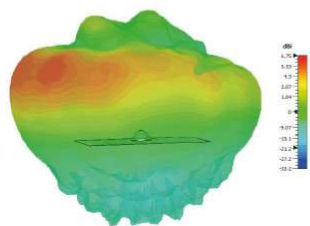

Typical 3D Pattern Side -2600MHz

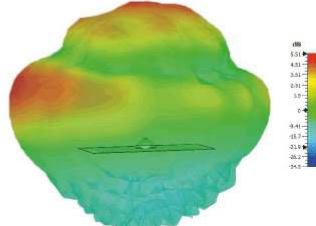

Typical 3D Pattern Side -3600MHz

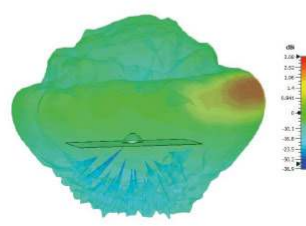

3D Patterns - Element 2

Typical 3D Pattern Side -2400MHz

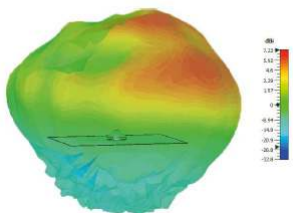

Typical 3D Pattern Side -5400MHz

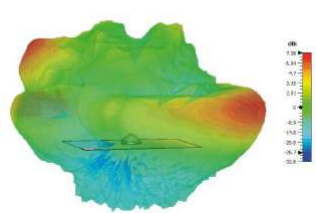

Typical Pattern - Element 3

Typical E-Plane 1575MHz

