

NTA4153N, NTE4153N, NVA4153N, NVE4153N

MOSFET – Single, N-Channel with ESD Protection, Small Signal, SC-75 and SC-89 20 V, 915 mA

Features

- Low $R_{DS(on)}$ Improving System Efficiency
- Low Threshold Voltage, 1.5 V Rated
- ESD Protected Gate
- NV Prefix for Automotive and Other Applications Requiring Unique Site and Control Change Requirements; AEC-Q101 Qualified and PPAP Capable
- Pb-Free Packages are Available

Applications

- Load/Power Switches
- Power Supply Converter Circuits
- Battery Management
- Portables like Cell Phones, PDAs, Digital Cameras, Pagers, etc.

MAXIMUM RATINGS ($T_J = 25^\circ\text{C}$ unless otherwise stated)

Parameter		Symbol	Value	Units	
Drain-to-Source Voltage		V_{DSS}	20	V	
Gate-to-Source Voltage		V_{GS}	± 6.0	V	
Continuous Drain Current (Note 1)	Steady State	I_D	$T_A = 25^\circ\text{C}$	915	mA
			$T_A = 85^\circ\text{C}$	660	
Power Dissipation (Note 1)	Steady State	P_D	300	mW	
Pulsed Drain Current	$t_p = 10 \mu\text{s}$	I_{DM}	1.3	A	
Operating Junction and Storage Temperature		T_J, T_{STG}	-55 to 150	$^\circ\text{C}$	
Continuous Source Current (Body Diode)		I_S	280	mA	
Lead Temperature for Soldering Purposes (1/8" from case for 10 s)		T_L	260	$^\circ\text{C}$	

THERMAL RESISTANCE RATINGS

Parameter	Symbol	Value	Units
Junction-to-Ambient – Steady State (Note 1) SC-75 / SOT-416 SC-89	$R_{\theta JA}$	416 400	$^\circ\text{C/W}$

Stresses exceeding those listed in the Maximum Ratings table may damage the device. If any of these limits are exceeded, device functionality should not be assumed, damage may occur and reliability may be affected.

1. Surface mounted on FR4 board using 1 in sq pad size (Cu area = 1.127 in sq [1 oz] including traces).



ON Semiconductor®

<http://onsemi.com>

$V_{(BR)DSS}$	$R_{DS(on)}$ TYP	I_D MAX
20 V	0.127 Ω @ 4.5 V	915 mA
	0.170 Ω @ 2.5 V	
	0.242 Ω @ 1.8 V	
	0.500 Ω @ 1.5 V	

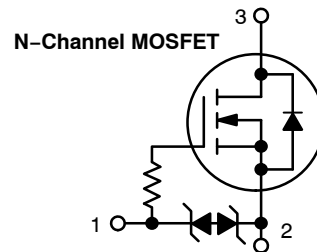

MARKING DIAGRAM & PIN ASSIGNMENT

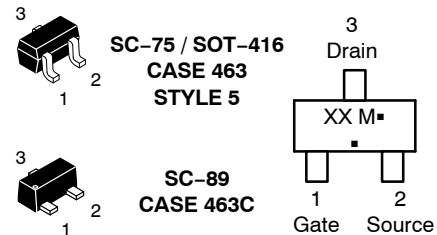

XX = Device Code
M = Date Code*
▪ = Pb-Free Package
(Note: Microdot may be in either location)

*Date Code orientation may vary depending upon manufacturing location.

SC-75, SC-89

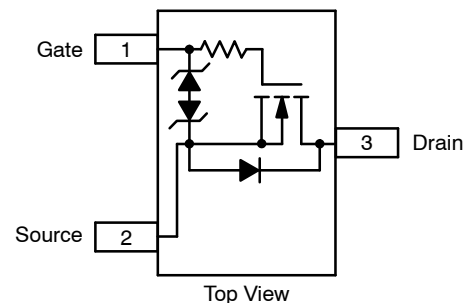

ORDERING INFORMATION

See detailed ordering and shipping information on page 4 of this data sheet.

NTA4153N, NTE4153N, NVA4153N, NVE4153N

ELECTRICAL CHARACTERISTICS (T_J = 25°C unless otherwise stated)

Parameter	Symbol	Test Condition	Min	Typ	Max	Unit
-----------	--------	----------------	-----	-----	-----	------

OFF CHARACTERISTICS

Drain-to-Source Breakdown Voltage	V _{(BR)DSS}	V _{GS} = 0 V, I _D = 250 μA	20	26		V
Drain-to-Source Breakdown Voltage Temperature Coefficient	V _{(BR)DSS} /T _J			18.4		mV/°C
Zero Gate Voltage Drain Current	I _{DSS}	V _{GS} = 0 V, V _{DS} = 16 V			100	nA
Gate-to-Source Leakage Current	I _{GSS}	V _{DS} = 0 V, V _{GS} = ±4.5 V			±1.0	μA

ON CHARACTERISTICS (Note 2)

Gate Threshold Voltage	V _{GS(TH)}	V _{GS} = V _{DS} , I _D = 250 μA	0.45	0.76	1.1	V
Negative Threshold Temperature Coefficient	V _{GS(TH)} /T _J			-2.15		mV/°C
Drain-to-Source On Resistance	R _{DS(on)}	V _{GS} = 4.5 V, I _D = 600 mA		127	230	mΩ
		V _{GS} = 2.5 V, I _D = 500 mA		170	275	
		V _{GS} = 1.8 V, I _D = 350 mA		242	700	
		V _{GS} = 1.5 V, I _D = 40 mA		500	950	
Forward Transconductance	g _{FS}	V _{DS} = 10 V, I _D = 400 mA		1.4		S

CHARGES AND CAPACITANCES

Input Capacitance	C _{ISS}	V _{GS} = 0 V, f = 1.0 MHz, V _{DS} = 16 V		110		pF
Output Capacitance	C _{OSS}			16		
Reverse Transfer Capacitance	C _{RSS}			12		
Total Gate Charge	Q _{G(TOT)}	V _{GS} = 4.5 V, V _{DS} = 10 V, I _D = 0.2 A		1.82		nC
Threshold Gate Charge	Q _{G(TH)}			0.2		
Gate-to-Source Charge	Q _{GS}			0.3		
Gate-to-Drain Charge	Q _{GD}			0.42		

SWITCHING CHARACTERISTICS (Note 3)

Turn-On Delay Time	t _{d(ON)}	V _{GS} = 4.5 V, V _{DD} = 10 V, I _D = 0.2 A, R _G = 10 Ω		3.7		ns
Rise Time	t _r			4.4		
Turn-Off Delay Time	t _{d(OFF)}			25		
Fall Time	t _f			7.6		

DRAIN-SOURCE DIODE CHARACTERISTICS

Forward Diode Voltage	V _{SD}	V _{GS} = 0 V, I _S = 200 mA	T _J = 25°C	0.67	1.1	V
			T _J = 125°C	0.54		

Product parametric performance is indicated in the Electrical Characteristics for the listed test conditions, unless otherwise noted. Product performance may not be indicated by the Electrical Characteristics if operated under different conditions.

2. Pulse Test: pulse width ≤ 300 μs, duty cycle ≤ 2%.

3. Switching characteristics are independent of operating junction temperatures.

TYPICAL ELECTRICAL CHARACTERISTICS

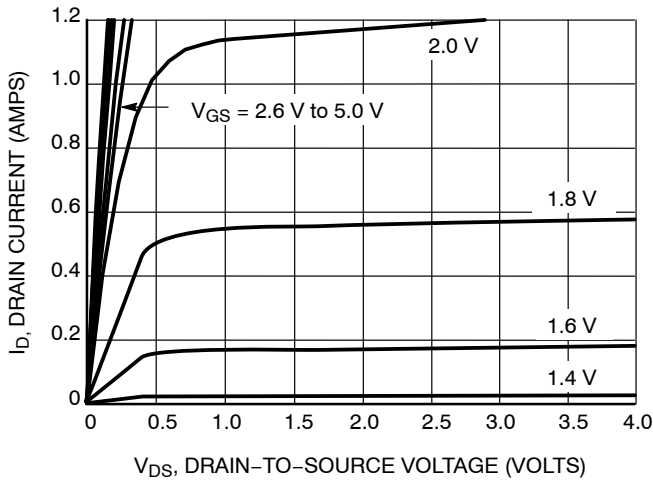

Figure 1. On-Region Characteristics

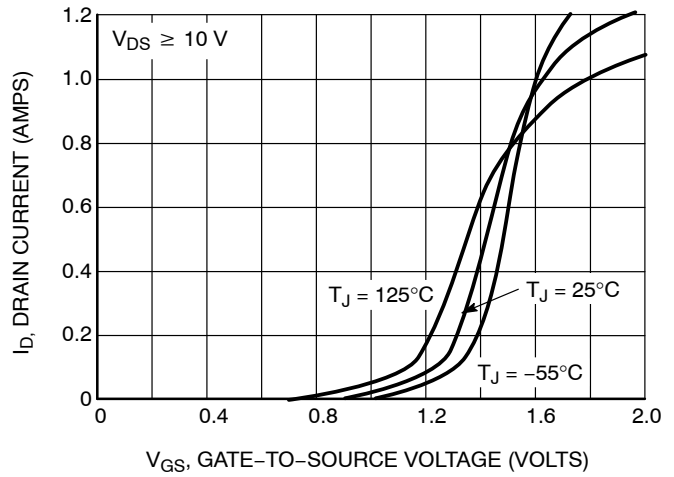

Figure 2. Transfer Characteristics

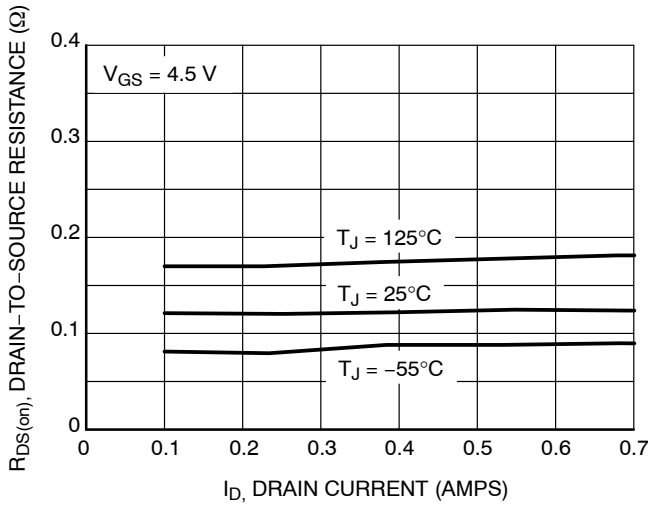

Figure 3. On-Resistance vs. Drain Current and Temperature

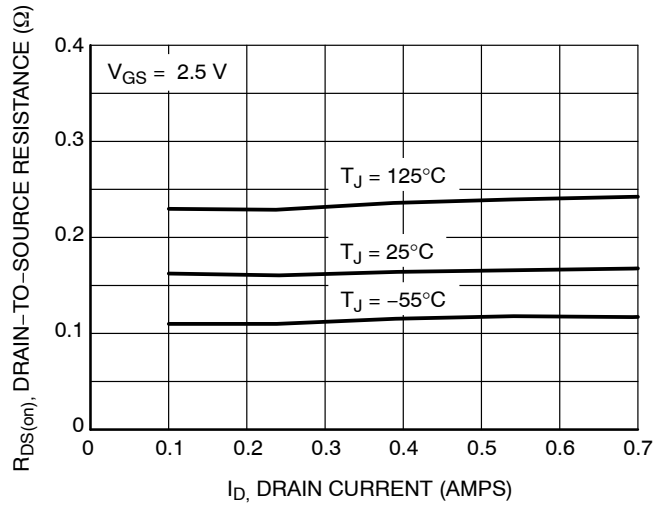

Figure 4. On-Resistance vs. Drain Current and Temperature

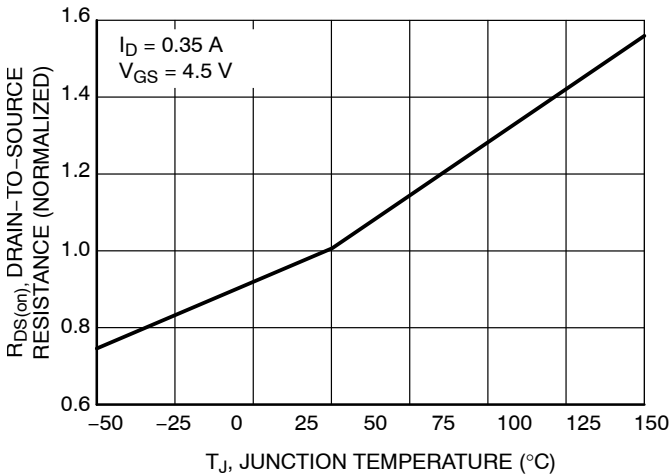

Figure 5. On-Resistance Variation with Temperature

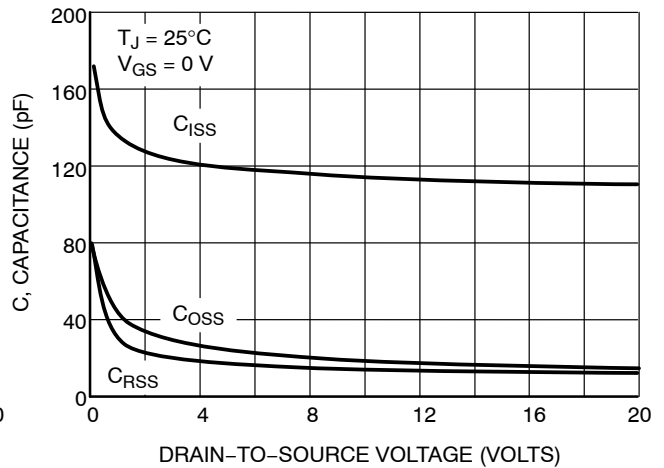

Figure 6. Capacitance Variation

NTA4153N, NTE4153N, NVA4153N, NVE4153N

TYPICAL ELECTRICAL CHARACTERISTICS

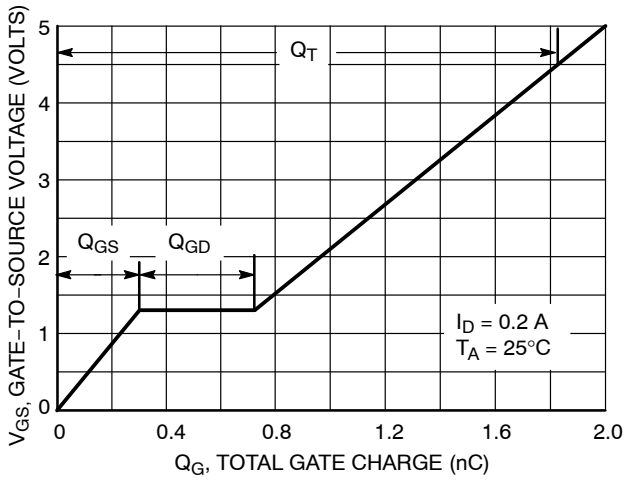

Figure 7. Gate-to-Source Voltage vs. Total Gate Charge

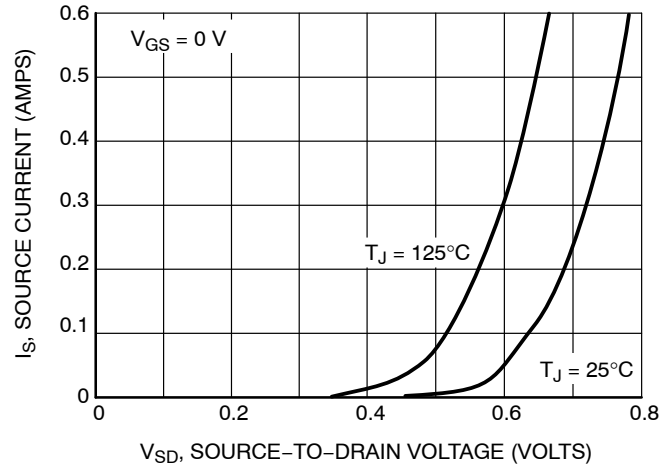

Figure 8. Diode Forward Voltage vs. Current

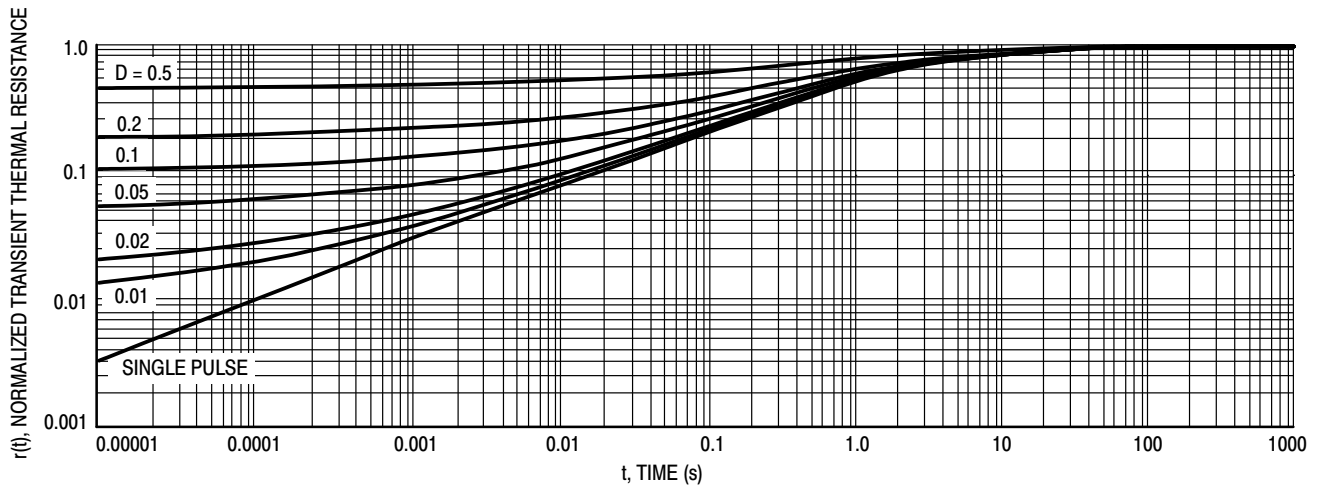

Figure 9. Normalized Thermal Response

ORDERING INFORMATION

Device	Marking	Package	Shipping [†]
NTA4153NT1	TR	SC-75 / SOT-416	3000 / Tape & Reel
NTA4153NT1G	TR	SC-75 / SOT-416 (Pb-Free)	3000 / Tape & Reel
NTE4153NT1G	TP	SC-89 (Pb-Free)	3000 / Tape & Reel
NVA4153NT1G	VR	SC-75 / SOT-416 (Pb-Free)	3000 / Tape & Reel
NVE4153NT1G	VP	SC-89 (Pb-Free)	3000 / Tape & Reel

[†]For information on tape and reel specifications, including part orientation and tape sizes, please refer to our Tape and Reel Packaging Specifications Brochure, BRD8011/D.

MECHANICAL CASE OUTLINE

PACKAGE DIMENSIONS

ON Semiconductor®

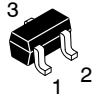

SC-75/SOT-416
CASE 463-01
ISSUE G

DATE 07 AUG 2015

SCALE 4:1

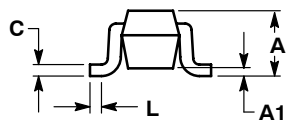
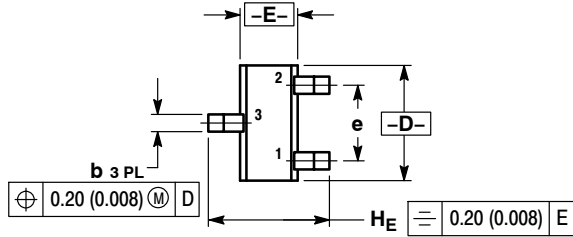

STYLE 1:
PIN 1. BASE
2. EMITTER
3. COLLECTOR

STYLE 2:
PIN 1. ANODE
2. N/C
3. CATHODE

STYLE 3:
PIN 1. ANODE
2. ANODE
3. CATHODE

STYLE 4:
PIN 1. CATHODE
2. CATHODE
3. ANODE

STYLE 5:
PIN 1. GATE
2. SOURCE
3. DRAIN

NOTES:

- DIMENSIONING AND TOLERANCING PER ANSI Y14.5M, 1982.
- CONTROLLING DIMENSION: MILLIMETER.

DIM	MILLIMETERS			INCHES		
	MIN	NOM	MAX	MIN	NOM	MAX
A	0.70	0.80	0.90	0.027	0.031	0.035
A1	0.00	0.05	0.10	0.000	0.002	0.004
b	0.15	0.20	0.30	0.006	0.008	0.012
C	0.10	0.15	0.25	0.004	0.006	0.010
D	1.55	1.60	1.65	0.061	0.063	0.065
E	0.70	0.80	0.90	0.027	0.031	0.035
e	1.00 BSC			0.04 BSC		
L	0.10	0.15	0.20	0.004	0.006	0.008
HE	1.50	1.60	1.70	0.060	0.063	0.067

GENERIC MARKING DIAGRAM*

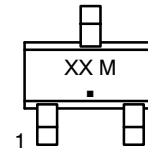

- XX = Specific Device Code
- M = Date Code
- = Pb-Free Package

*This information is generic. Please refer to device data sheet for actual part marking. Pb-Free indicator, "G" or microdot "■", may or may not be present.

SOLDERING FOOTPRINT*

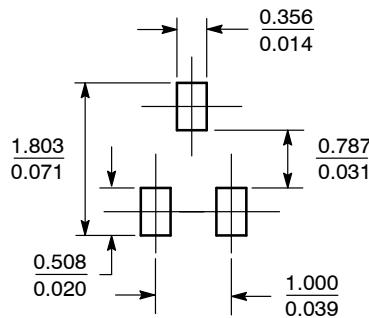

SCALE 10:1 (mm/inches)

*For additional information on our Pb-Free strategy and soldering details, please download the ON Semiconductor Soldering and Mounting Techniques Reference Manual, SOLDERRM/D.

DOCUMENT NUMBER:	98ASB15184C	Electronic versions are uncontrolled except when accessed directly from the Document Repository. Printed versions are uncontrolled except when stamped "CONTROLLED COPY" in red.
DESCRIPTION:	SC-75/SOT-416	PAGE 1 OF 1

ON Semiconductor and ON are trademarks of Semiconductor Components Industries, LLC dba ON Semiconductor or its subsidiaries in the United States and/or other countries. ON Semiconductor reserves the right to make changes without further notice to any products herein. ON Semiconductor makes no warranty, representation or guarantee regarding the suitability of its products for any particular purpose, nor does ON Semiconductor assume any liability arising out of the application or use of any product or circuit, and specifically disclaims any and all liability, including without limitation special, consequential or incidental damages. ON Semiconductor does not convey any license under its patent rights nor the rights of others.

MECHANICAL CASE OUTLINE

PACKAGE DIMENSIONS

ON Semiconductor®



SC-89, 3 LEAD CASE 463C-03 ISSUE C

DATE 31 JUL 2003



SCALE 4:1

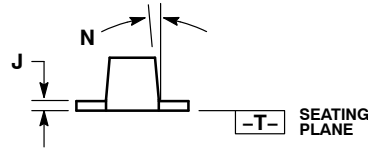
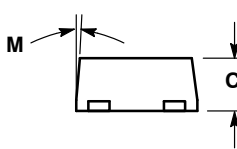
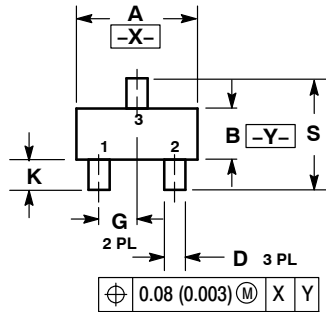

STYLE 1:
PIN 1. BASE
2. EMITTER
3. COLLECTOR

STYLE 2:
PIN 1. ANODE
2. N/C
3. CATHODE

STYLE 3:
PIN 1. ANODE
2. ANODE
3. CATHODE

STYLE 4:
PIN 1. CATHODE
2. CATHODE
3. ANODE

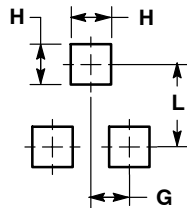

RECOMMENDED PATTERN OF SOLDER PADS

NOTES:

- DIMENSIONING AND TOLERANCING PER ANSI Y14.5M, 1982.
- CONTROLLING DIMENSION: MILLIMETERS
- MAXIMUM LEAD THICKNESS INCLUDES LEAD FINISH THICKNESS. MINIMUM LEAD THICKNESS IS THE MINIMUM THICKNESS OF BASE MATERIAL.
- 463C-01 OBSOLETE, NEW STANDARD 463C-02.

DIM	MILLIMETERS			INCHES		
	MIN	NOM	MAX	MIN	NOM	MAX
A	1.50	1.60	1.70	0.059	0.063	0.067
B	0.75	0.85	0.95	0.030	0.034	0.040
C	0.60	0.70	0.80	0.024	0.028	0.031
D	0.23	0.28	0.33	0.009	0.011	0.013
G	0.50 BSC			0.020 BSC		
H	0.53 REF			0.021 REF		
J	0.10	0.15	0.20	0.004	0.006	0.008
K	0.30	0.40	0.50	0.012	0.016	0.020
L	1.10 REF			0.043 REF		
M	---	---	10	---	---	10
N	---	---	10	---	---	10
S	1.50	1.60	1.70	0.059	0.063	0.067

GENERIC MARKING DIAGRAM*

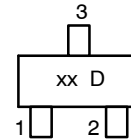

xx = Specific Device Code
D = Date Code

*This information is generic. Please refer to device data sheet for actual part marking.

DOCUMENT NUMBER:	98AON11472D	Electronic versions are uncontrolled except when accessed directly from the Document Repository. Printed versions are uncontrolled except when stamped "CONTROLLED COPY" in red.
DESCRIPTION:	SC-89, 3 LEAD	PAGE 1 OF 1

ON Semiconductor and are trademarks of Semiconductor Components Industries, LLC dba ON Semiconductor or its subsidiaries in the United States and/or other countries. ON Semiconductor reserves the right to make changes without further notice to any products herein. ON Semiconductor makes no warranty, representation or guarantee regarding the suitability of its products for any particular purpose, nor does ON Semiconductor assume any liability arising out of the application or use of any product or circuit, and specifically disclaims any and all liability, including without limitation special, consequential or incidental damages. ON Semiconductor does not convey any license under its patent rights nor the rights of others.

onsemi, **Onsemi**, and other names, marks, and brands are registered and/or common law trademarks of Semiconductor Components Industries, LLC dba "**onsemi**" or its affiliates and/or subsidiaries in the United States and/or other countries. **onsemi** owns the rights to a number of patents, trademarks, copyrights, trade secrets, and other intellectual property. A listing of **onsemi**'s product/patent coverage may be accessed at www.onsemi.com/site/pdf/Patent-Marking.pdf. **onsemi** reserves the right to make changes at any time to any products or information herein, without notice. The information herein is provided "as-is" and **onsemi** makes no warranty, representation or guarantee regarding the accuracy of the information, product features, availability, functionality, or suitability of its products for any particular purpose, nor does **onsemi** assume any liability arising out of the application or use of any product or circuit, and specifically disclaims any and all liability, including without limitation special, consequential or incidental damages. Buyer is responsible for its products and applications using **onsemi** products, including compliance with all laws, regulations and safety requirements or standards, regardless of any support or applications information provided by **onsemi**. "Typical" parameters which may be provided in **onsemi** data sheets and/or specifications can and do vary in different applications and actual performance may vary over time. All operating parameters, including "Typicals" must be validated for each customer application by customer's technical experts. **onsemi** does not convey any license under any of its intellectual property rights nor the rights of others. **onsemi** products are not designed, intended, or authorized for use as a critical component in life support systems or any FDA Class 3 medical devices or medical devices with a same or similar classification in a foreign jurisdiction or any devices intended for implantation in the human body. Should Buyer purchase or use **onsemi** products for any such unintended or unauthorized application, Buyer shall indemnify and hold **onsemi** and its officers, employees, subsidiaries, affiliates, and distributors harmless against all claims, costs, damages, and expenses, and reasonable attorney fees arising out of, directly or indirectly, any claim of personal injury or death associated with such unintended or unauthorized use, even if such claim alleges that **onsemi** was negligent regarding the design or manufacture of the part. **onsemi** is an Equal Opportunity/Affirmative Action Employer. This literature is subject to all applicable copyright laws and is not for resale in any manner.

ADDITIONAL INFORMATION

TECHNICAL PUBLICATIONS:

Technical Library: www.onsemi.com/design/resources/technical-documentation
onsemi Website: www.onsemi.com

ONLINE SUPPORT: www.onsemi.com/support

For additional information, please contact your local Sales Representative at www.onsemi.com/support/sales