

SMJ4C1024

1 048576-BIT DYNAMIC RANDOM-ACCESS MEMORY

SGMS023E - DECEMBER 1988 - REVISED MARCH 1996

- Organization . . . 1048576 × 1
- Processed to MIL-STD-883, Class B
- Single 5-V Supply (10% Tolerance)
- Performance Ranges:

	ACCESS TIME	ACCESS TIME	ACCESS TIME	READ OR WRITE CYCLE (MIN)
	$t_a(R)$ (t_{RAC}) (MAX)	$t_a(C)$ (t_{CAC}) (MAX)	$t_a(CA)$ (t_{AA}) (MAX)	
'4C1024-80	80 ns	20 ns	40 ns	150 ns
'4C1024-10	100 ns	25 ns	45 ns	190 ns
'4C1024-12	120 ns	30 ns	55 ns	220 ns
'4C1024-15	150 ns	40 ns	70 ns	260 ns

- Enhanced Page Mode Operation for Faster Memory Access

- Higher Data Bandwidth Than Conventional Page Mode Parts
- Random Single-Bit Access Within a Row With a Column Address

- One of TI's CMOS Megabit Dynamic Random-Access Memory (DRAM) Family Including SMJ44C256 — 256K × 4 Enhanced Page Mode

- CAS-Before-RAS (CBR) Refresh

- Long Refresh Period
512-Cycle Refresh in 8 ms (Max)

- 3-State Unlatched Output

- Low Power Dissipation

- Fabricated Using the Texas Instruments Enhanced Performance Implanted CMOS (EPIC™) Process

- All Inputs/Outputs and Clocks Are TTL-Compatible

- Packaging Offered:

- 20/26-Pin J-Leaded Ceramic Surface Mount Package (HJ Suffix)
- 18-Pin 300-Mil Ceramic Dual-In-Line Package (JD Suffix)
- 20-Pin Ceramic Flatpack (HK Suffix)
- 20/26-Terminal Leadless Ceramic Surface Mount Package (FQ/HL Suffixes)
- 20-Pin Ceramic Zig-Zag In-Line Package (SV Suffix)

- Operating Temperature Range
- 55°C to 125°C

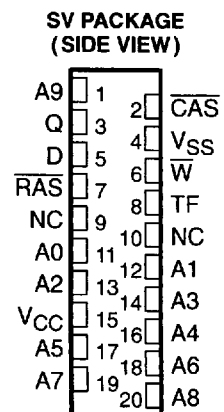
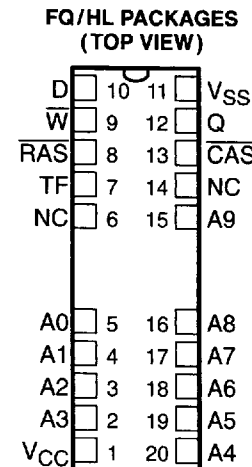
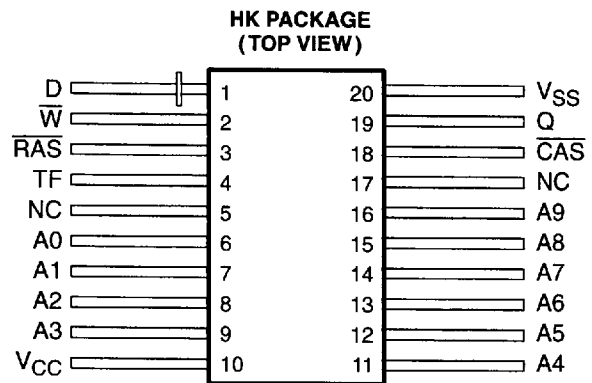
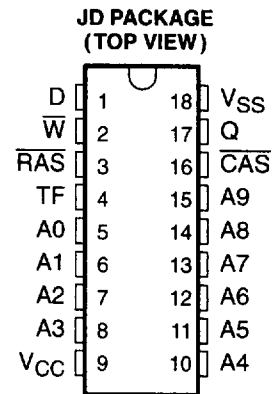
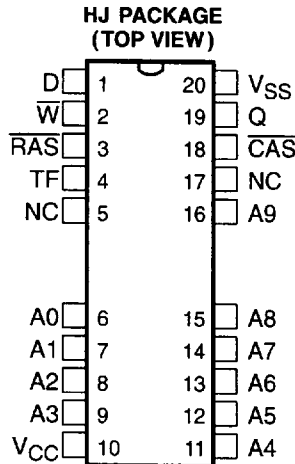

Please be aware that an important notice concerning availability, standard warranty, and use in critical applications of Texas Instruments semiconductor products and disclaimers thereto appears at the end of this data sheet.

EPIC is a trademark of Texas Instruments Incorporated.

PRODUCTION DATA information is current as of publication date. Products conform to specifications per the terms of Texas Instruments standard warranty. Production processing does not necessarily include testing of all parameters.

**TEXAS
INSTRUMENTS**

POST OFFICE BOX 655303 • DALLAS, TEXAS 75265
POST OFFICE BOX 1443 • HOUSTON, TEXAS 77251-1443

Copyright © 1996, Texas Instruments Incorporated

8961725 0086485 850

SMJ4C1024 1048576-BIT DYNAMIC RANDOM-ACCESS MEMORY

SGMS023E – DECEMBER 1988 – REVISED MARCH 1996

PIN NOMENCLATURE	
A0–A9	Address Inputs
CAS	Column Address Strobe
D	Data In
NC	No Internal Connection
Q	Data Out
$\overline{\text{RAS}}$	Row Address Strobe
TF	Test Function
VCC	5-V Supply
VSS	Ground
W	Write Enable

description

The SMJ4C1024 is a high-speed, 1 048 576-bit DRAM organized as 1 048 576 words of one bit each. It employs EPIC™ technology for high performance, reliability, and low power at a low cost.

This device features maximum $\overline{\text{RAS}}$ access times of 80 ns, 100 ns, 120 ns, and 150 ns. Maximum power dissipation is as low as 305 mW operating and 16.5 mW standby on 150-ns devices.

The EPIC™ technology permits operation from a single 5-V supply, reducing system power supply and decoupling requirements and easing board layout. I_{DD} peaks are typically 140 mA and a –1 V input voltage undershoot can be tolerated, minimizing system noise.

All inputs and outputs, including clocks, are compatible with series 54 TTL. All addresses and data-in lines are latched on-chip to simplify system design. Data out is unlatched to allow greater system flexibility.

The SMJ4C1024 is offered in an 18-pin ceramic dual-in-line package (JD suffix), a 20/26-terminal leadless ceramic carrier package (FQ/HL suffixes), a 20/26-pin J-leaded carrier package (HJ suffix), a 20-pin flatpack (HK suffix), and a 20-pin ceramic zig-zag in-line package (SV suffix). They are characterized for operation from –55°C to 125°C.

■ 8961725 0086486 797 ■

 **TEXAS
INSTRUMENTS**

POST OFFICE BOX 655303 • DALLAS, TEXAS 75265
POST OFFICE BOX 1443 • HOUSTON, TEXAS 77251-1443

SMJ4C1024 1048576-BIT DYNAMIC RANDOM-ACCESS MEMORY

SGMS023E – DECEMBER 1988 – REVISED MARCH 1996

logic symbol†

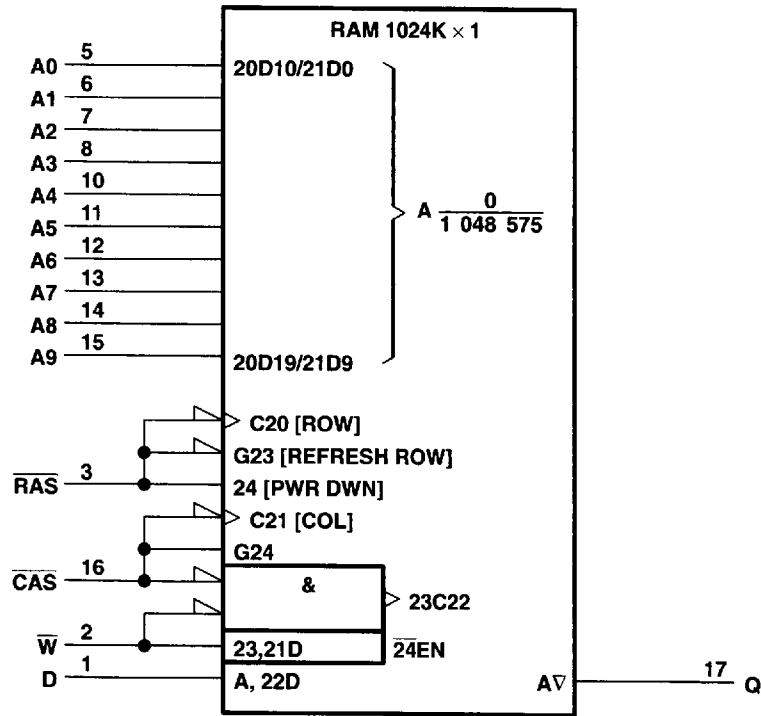

† This symbol is in accordance with ANSI/IEEE Std. 91-1984 and IEC Publication 617-12.
The pin numbers shown are for the 18-pin JD package.

SMJ4C1024 1048576-BIT DYNAMIC RANDOM-ACCESS MEMORY

SGMS023E – DECEMBER 1988 – REVISED MARCH 1996

functional block diagram

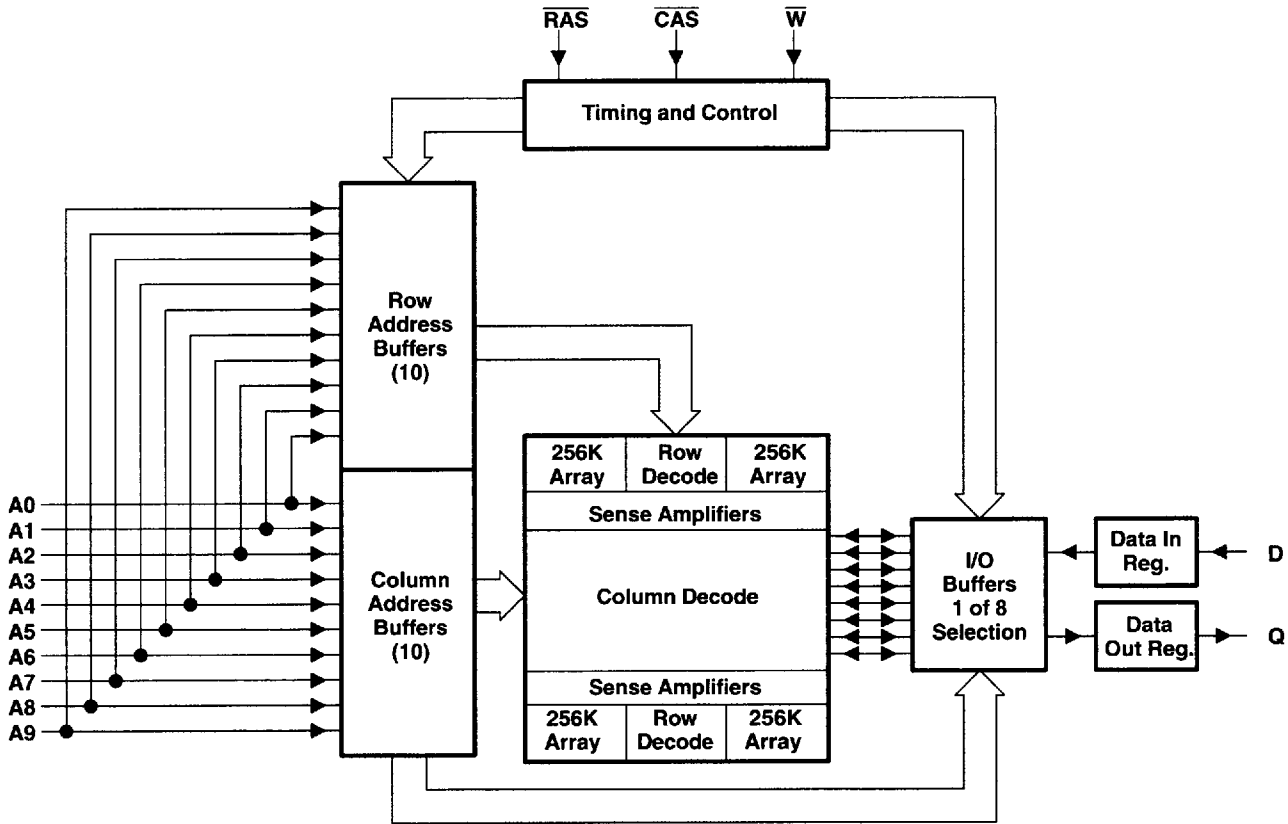

operation

enhanced page mode

Enhanced page-mode operation allows faster memory access by keeping the same row address while selecting random column addresses. The time for row-address setup and hold and for address multiplexing is eliminated. The maximum number of columns that can be accessed is determined by the maximum $\overline{\text{RAS}}$ low time and the $\overline{\text{CAS}}$ page-cycle time used. With minimum $\overline{\text{CAS}}$ page-cycle time, all 1024 columns specified by column addresses A0 through A9 can be accessed without intervening $\overline{\text{RAS}}$ cycles.

Unlike conventional page-mode DRAMs, the column-address buffers in this device are activated on the falling edge of $\overline{\text{RAS}}$. The buffers act as transparent or flow-through latches while $\overline{\text{CAS}}$ is high. The falling edge of $\overline{\text{CAS}}$ latches the column addresses. This feature lets the SMJ4C1024 operate at a higher data bandwidth than conventional page-mode parts, since data retrieval begins as soon as the column address is valid rather than when $\overline{\text{CAS}}$ goes low. This performance improvement is referred to as enhanced page mode. A valid column address can be presented immediately after the row-address hold time has been satisfied, usually well in advance of the falling edge of $\overline{\text{CAS}}$. In this case, data is obtained after $t_{a(C)}$ maximum (access time from $\overline{\text{CAS}}$ low) if $t_{a(CA)}$ maximum (access time from column address) has been satisfied. If the column addresses for the next page cycle are valid at the same time $\overline{\text{CAS}}$ goes high, access time for the next cycle is determined by the later occurrence of $t_{a(CA)}$ or $t_{a(CP)}$ (access time from rising edge of $\overline{\text{CAS}}$).

address (A0–A9)

Twenty address bits are required to decode one of 1048576 storage cell locations. Ten row-address bits are set up on inputs A0 through A9 and latched onto the chip by $\overline{\text{RAS}}$. The ten column-address bits are set up on pins A0 through A9 and latched onto the chip by $\overline{\text{CAS}}$. All addresses must be stable on or before the falling edges

of \overline{RAS} and \overline{CAS} . \overline{RAS} is similar to a chip enable in that it activates the sense amplifiers as well as the row decoder. \overline{CAS} is used as a chip select to activate the output buffer as well as to latch the address bits into the column-address buffer.

write enable (\overline{W})

The read or write mode is selected through \overline{W} . A logic high on the \overline{W} input selects the read mode and a logic low selects the write mode. The write-enable pin can be driven from standard TTL circuits without a pullup resistor. The data input is disabled when the read mode is selected. When \overline{W} goes low prior to \overline{CAS} (early write), data out remains in the high-impedance state for the entire cycle, permitting common input/output operation.

data in (D)

Data-in is written during a write or a read-modify-write cycle. Depending on the mode of operation, the falling edge of \overline{CAS} or \overline{W} strobes data into the on-chip latch. In an early-write cycle, \overline{W} is brought low prior to \overline{CAS} , and the data is strobed in by \overline{CAS} with setup and hold times referenced to this signal. In a delayed-write or a read-modify-write cycle, \overline{CAS} is already low, and the data is strobed in by \overline{W} with setup and hold times referenced to this signal.

data out (Q)

The 3-state output buffers provide direct TTL compatibility (no pullup resistor required) with a fanout of two series 54 TTL loads. Data out is the same polarity as data in. The output is in the high-impedance (floating) state until \overline{CAS} is brought low. In a read cycle, the output becomes valid after the access time $t_{a(C)}$. The access time from \overline{CAS} low ($t_{a(C)}$) begins with the negative transition of \overline{CAS} as long as $t_{a(R)}$ and $t_{a(CA)}$ are satisfied. The output becomes valid after the access time has elapsed and remains valid while \overline{CAS} is low; when \overline{CAS} goes high, the output returns to a high-impedance state. In a delayed-write or read-modify-write cycle, the output follows the sequence for the read cycle.

refresh

A refresh operation must be performed at least once every 8 ms to retain data. This can be achieved by strobing each of the 512 rows (A0–A8). A normal read or write cycle refreshes all bits in each selected row. A \overline{RAS} -only operation can be used by holding \overline{CAS} at the high (inactive) level, conserving power as the output buffer remains in the high-impedance state. Externally generated addresses must be used for a \overline{RAS} -only refresh. Hidden refresh can be performed while maintaining valid data at the output pin. This is accomplished by holding \overline{CAS} at V_{IL} after a read operation and cycling \overline{RAS} after a specified precharge period, similar to a \overline{RAS} -only refresh cycle.

\overline{CAS} -before- \overline{RAS} (CBR) refresh

CBR refresh is used by bringing \overline{CAS} low earlier than \overline{RAS} (see parameter $t_{d(CLRL)R}$) and holding it low after \overline{RAS} falls (parameter $t_{d(RLCH)R}$). For successive CBR refresh cycles, \overline{CAS} can remain low while cycling \overline{RAS} . The external address is ignored and the refresh address is generated internally. The external address is also ignored during the hidden refresh cycles.

power up

To achieve proper device operation, an initial pause of 200 μ s followed by a minimum of eight initialization cycles is required after full V_{CC} level is achieved.

test function (TF) pin

During normal device operation, TF must be disconnected or biased at a voltage $\leq V_{CC}$.

SMJ4C1024

1048576-BIT DYNAMIC RANDOM-ACCESS MEMORY

SGMS023E – DECEMBER 1988 – REVISED MARCH 1996

absolute maximum ratings over operating free-air temperature range (unless otherwise noted)†

Voltage range on any pin (see Note 1)	– 1 V to 7 V
Voltage range on V_{CC}	– 1 V to 7 V
Short-circuit output current, I_{OS}	50 mA
Power dissipation	1 W
Operating free-air temperature range, T_A	– 55°C to 125°C
Storage temperature range, T_{stg}	– 65°C to 150°C

† Stresses beyond those listed under “absolute maximum ratings” may cause permanent damage to the device. These are stress ratings only, and functional operation of the device at these or any other conditions beyond those indicated under “recommended operating conditions” is not implied. Exposure to absolute-maximum-rated conditions for extended periods may affect device reliability.

NOTE 1: All voltage values are with respect to V_{SS} .

recommended operating conditions

	MIN	NOM	MAX	UNIT
V_{CC} Supply voltage	4.5	5	5.5	V
V_{IH} High-level input voltage	2.4		6.5	V
V_{IL} Low-level input voltage (see Note 2)	– 1		0.8	V
T_A Minimum operating free-air temperature	– 55			°C
T_C Maximum operating case temperature			125	°C

NOTE 2: The algebraic convention, where the more negative (less positive) limit is designated as minimum, is used for logic-voltage levels only.

8961725 0086490 118



POST OFFICE BOX 655303 • DALLAS, TEXAS 75265
POST OFFICE BOX 1443 • HOUSTON, TEXAS 77251-1443

SMJ4C1024 1 048576-BIT DYNAMIC RANDOM-ACCESS MEMORY

SGMS023E – DECEMBER 1988 – REVISED MARCH 1996

electrical characteristics over recommended ranges of supply voltage and operating free-air temperature (unless otherwise noted)

PARAMETER	TEST CONDITIONS	'4C1024-80		'4C1024-10		'4C1024-12		'4C1024-15		UNIT
		MIN	MAX	MIN	MAX	MIN	MAX	MIN	MAX	
V _{OH}	High-level output voltage I _{OH} = - 5 mA	2.4		2.4		2.4		2.4		V
V _{OL}	Low-level output voltage I _{OL} = 4.2 mA	0.4		0.4		0.4		0.4		V
I _I	Input current (leakage) V _{CC} = 5.5 V, V _I = 0 V to 6.5 V, All other pins = 0 V to V _{CC}	± 10		± 10		± 10		± 10		µA
I _O	Output current (leakage) V _{CC} = 5.5 V, V _O = 0 V to V _{CC} , CAS high	± 10		± 10		± 10		± 10		µA
I _{CC1}	Read- or write-cycle current V _{CC} = 5.5 V, Minimum cycle	75		70		60		55		mA
I _{CC2}	Standby current After one memory cycle, RAS and CAS high, V _{IH} = 2.4 V	3		3		3		3		mA
I _{CC3}	Average refresh current (RAS only or CBR) V _{CC} = 5.5 V, Minimum cycle, RAS cycling, CAS high (RAS only), RAS low after CAS low (CBR)	70		65		55		50		mA
I _{CC4}	Average page current V _{CC} = 5.5 V, t _{PC} = minimum, RAS low, CAS cycling	50		45		35		30		mA

capacitance over recommended ranges of supply voltage and operating free-air temperature, f = 1 MHz (see Note 3)

PARAMETER	HL/JD/FQ		HJ		HK		SV		UNIT
	MIN	MAX	MIN	MAX	MIN	MAX	MIN	MAX	
C _{i(A)}	Input capacitance, address inputs		6		7		8		pF
C _{i(D)}	Input capacitance, data input		5		5		6		pF
C _{i(RC)}	Input capacitance, strobe inputs		7		7		8		pF
C _{i(W)}	Input capacitance, write-enable input		7		7		7		pF
C _O	Output capacitance		7		9		10		pF

NOTE 3: Capacitance is sampled only at initial design and after any major change. Samples are tested at 0 V and 25°C with a 1-MHz signal applied to the pin under test. All other pins are open.

switching characteristics over recommended ranges of supply voltage and operating free-air temperature (see Figure 1)

PARAMETER	ALT. SYMBOL	'4C1024-80		'4C1024-10		'4C1024-12		'4C1024-15		UNIT
		MIN	MAX	MIN	MAX	MIN	MAX	MIN	MAX	
t _{a(C)}	Access time from CAS low	20		25		30		40		ns
t _{a(CA)}	Access time from column address	40		45		55		70		ns
t _{a(R)}	Access time from RAS low	80		100		120		150		ns
t _{a(CP)}	Access time from column precharge	40		40		60		75		ns
t _{dis(CH)}	Output disable time after CAS high (see Note 4)	20		25		30		35		ns

NOTE 4: t_{dis(CH)} is specified when the output is no longer driven. The output is disabled by bringing CAS high.

8961725 0086491 054



POST OFFICE BOX 655303 • DALLAS, TEXAS 75265
POST OFFICE BOX 1443 • HOUSTON, TEXAS 77251-1443

SMJ4C1024

1048576-BIT DYNAMIC RANDOM-ACCESS MEMORY

SGMS023E - DECEMBER 1988 - REVISED MARCH 1996

timing requirements over recommended ranges of supply voltage and operating free-air temperature (see Note 5)

	ALT. SYMBOL	'4C1024-80		'4C1024-10		'4C1024-12		'4C1024-15		UNIT
		MIN	MAX	MIN	MAX	MIN	MAX	MIN	MAX	
$t_{c(rd)}$ Cycle time, read (see Note 6)	t_{RC}	150		190		220		260		ns
$t_{c(W)}$ Cycle time, write	t_{WC}	150		190		220		260		ns
$t_{c(rdW)}$ Cycle time, read-write/read-modify-write	t_{RWC}	175		220		265		315		ns
$t_{c(P)}$ Cycle time, page-mode read or write (see Note 7)	t_{PC}	50		55		65		80		ns
$t_{c(PM)}$ Cycle time, page-mode read-modify-write	t_{PRWC}	75		85		110		135		ns
$t_{w(CH)}$ Pulse duration, \overline{CAS} high	t_{CP}	10		10		15		25		ns
$t_{w(CL)}$ Pulse duration, \overline{CAS} low (see Note 8)	t_{CAS}	20	10 000	25	10 000	30	10 000	40	10 000	ns
$t_{w(RH)}$ Pulse duration, \overline{RAS} high (precharge)	t_{RP}	60		80		90		100		ns
$t_{w(RL)}$ Pulse duration, nonpage mode, \overline{RAS} low (see Note 9)	t_{RAS}	80	10 000	100	10 000	120	10 000	150	10 000	ns
$t_{w(RL)P}$ Pulse duration, page mode, \overline{RAS} low (see Note 9)	t_{RASP}	80	100 000	100	100 000	120	100 000	150	100 000	ns
$t_{w(WL)}$ Pulse duration, write	t_{WP}	15		15		20		25		ns
$t_{su(CA)}$ Setup time, column address before \overline{CAS} low	t_{ASC}	0		3		3		3		ns
$t_{su(RA)}$ Setup time, row address before \overline{RAS} low	t_{ASR}	0		0		0		0		ns
$t_{su(D)}$ Setup time, data (see Note 10)	t_{DS}	0		0		0		0		ns
$t_{su(rd)}$ Setup time, read before \overline{CAS} low	t_{RCS}	0		0		0		0		ns
$t_{su(WCL)}$ Setup time, \overline{W} low before \overline{CAS} low (see Note 11)	t_{WCS}	0		0		0		0		ns
$t_{su(WCH)}$ Setup time, \overline{W} low before \overline{CAS} high	t_{CWL}	20		25		30		40		ns
$t_{su(WRH)}$ Setup time, \overline{W} low before \overline{RAS} high	t_{RWL}	20		25		30		40		ns
$t_h(CA)$ Hold time, column address after \overline{CAS} low	t_{CAH}	15		20		20		25		ns
$t_h(RA)$ Hold time, row address after \overline{RAS} low	t_{RAH}	12		15		15		20		ns

- NOTES:
- Timing measurements in this table are referenced to V_{IL} max and V_{IH} min.
 - All cycle times assume $t_t = 5$ ns.
 - To assure $t_{c(P)}$ min, $t_{su(CA)}$ should be $\geq t_{w(CH)}$.
 - In a read-modify-write cycle, $t_{d(CLWL)}$ and $t_{su(WCH)}$ must be observed.
 - In a read-modify-write cycle, $t_{d(RLWL)}$ and $t_{su(WRH)}$ must be observed.
 - Referenced to the later of \overline{CAS} or \overline{W} in write operations
 - Early write operation only

8961725 0086492 T90



POST OFFICE BOX 655303 • DALLAS, TEXAS 75265
POST OFFICE BOX 1443 • HOUSTON, TEXAS 77251-1443

SMJ4C1024 1048576-BIT DYNAMIC RANDOM-ACCESS MEMORY

SGMS023E – DECEMBER 1988 – REVISED MARCH 1996

timing requirements over recommended ranges of supply voltage and operating free-air temperature (see Note 5) (continued)

	ALT. SYMBOL	'4C1024-80		'4C1024-10		'4C1024-12		'4C1024-15		UNIT
		MIN	MAX	MIN	MAX	MIN	MAX	MIN	MAX	
$t_{h(RLCA)}$ Hold time, column address after \overline{RAS} low (see Note 12)	t_{AR}	60		70		80		100		ns
$t_{h(D)}$ Hold time, data (see Note 10)	t_{DH}	15		20		25		30		ns
$t_{h(RLD)}$ Hold time, data after \overline{RAS} low (see Note 12)	t_{DHR}	60		70		85		110		ns
$t_{h(CHrd)}$ Hold time, read after \overline{CAS} high (see Note 13)	t_{RCH}	0		0		0		0		ns
$t_{h(RHrd)}$ Hold time, read after \overline{RAS} high (see Note 13)	t_{RRH}	10		10		10		10		ns
$t_{h(CLW)}$ Hold time, write after \overline{CAS} low (see Note 11)	t_{WCH}	15		20		25		30		ns
$t_{h(RLW)}$ Hold time, write after \overline{RAS} low (see Note 12)	t_{WCR}	60		70		85		100		ns
$t_d(RLCH)$ Delay time, \overline{RAS} low to \overline{CAS} high	t_{CSH}	80		100		120		150		ns
$t_d(CHRL)$ Delay time, \overline{CAS} high to \overline{RAS} low	t_{CRP}	0		0		0		0		ns
$t_d(CLRH)$ Delay time, \overline{CAS} low to \overline{RAS} high	t_{RSH}	20		25		30		40		ns
$t_d(CLWL)$ Delay time, \overline{CAS} low to \overline{W} low (see Note 14)	t_{CWD}	20		25		40		50		ns
$t_d(RLCL)$ Delay time, \overline{RAS} low to \overline{CAS} low (see Note 15)	t_{RCD}	22	60	28	75	28	90	33	110	ns
$t_d(RLCA)$ Delay time, \overline{RAS} low to column address (see Note 15)	t_{RAD}	17	40	20	55	20	65	25	80	ns
$t_d(CARH)$ Delay time, column address to \overline{RAS} high	t_{RAL}	40		45		55		70		ns
$t_d(CACH)$ Delay time, column address to \overline{CAS} high	t_{CAL}	40		45		55		70		ns
$t_d(RLWL)$ Delay time, \overline{RAS} low to \overline{W} low (see Note 14)	t_{RWD}	80		100		130		160		ns
$t_d(CAWL)$ Delay time, column address to \overline{W} low (see Note 14)	t_{AWD}	40		45		65		80		ns
$t_d(RLCH)R$ Delay time, \overline{RAS} low to \overline{CAS} high (see Note 16)	t_{CHR}	20		25		25		30		ns
$t_d(CLRL)R$ Delay time, \overline{CAS} low to \overline{RAS} low (see Note 16)	t_{CSR}	10		10		10		15		ns
$t_d(RHCL)R$ Delay time, \overline{RAS} high to \overline{CAS} low	t_{RPC}	0		0		0		0		ns
t_{rf} Refresh time interval	t_{REF}		8		8		8		8	ms
t_t Transition time (see Note 17)	—	—		—		—		—		ns

- NOTES: 5. Timing measurements in this table are referenced to V_{IL} max and V_{IH} min.
 10. Referenced to the later of \overline{CAS} or \overline{W} in write operations.
 11. Early-write operation only
 12. The minimum value is measured when $t_d(RLCL)$ is set $t_d(RLCL)$ min as a reference.
 13. Either $t_{h(RHrd)}$ or $t_{h(CHrd)}$ must be satisfied for a read cycle.
 14. Read-modify-write operation only
 15. Maximum value specified only to assure access time.
 16. CBR refresh only
 17. Transition times (rise and fall) for \overline{RAS} and \overline{CAS} are to be minimum of 3 ns and a maximum of 50 ns.

■ 8961725 0086493 927 ■



POST OFFICE BOX 655303 • DALLAS, TEXAS 75265
 POST OFFICE BOX 1443 • HOUSTON, TEXAS 77251-1443

SMJ4C1024 1048576-BIT DYNAMIC RANDOM-ACCESS MEMORY

SGMS023E – DECEMBER 1988 – REVISED MARCH 1996

PARAMETER MEASUREMENT INFORMATION

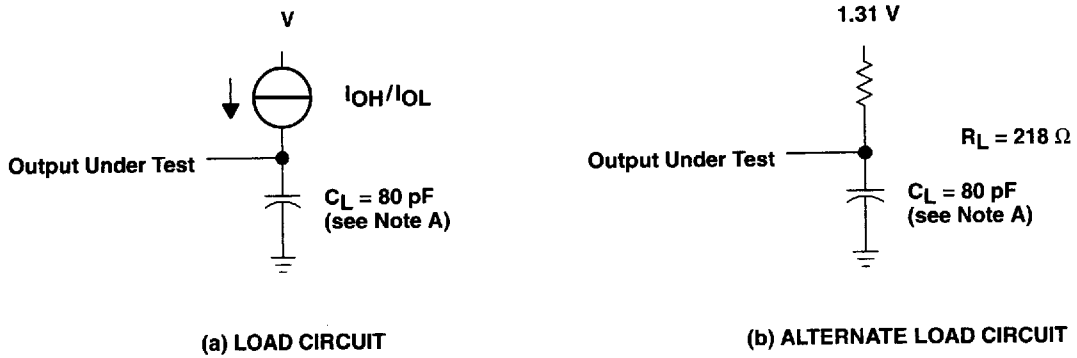

NOTE A: C_L includes probe and fixture capacitance.

Figure 1. Load Circuits for Timing Parameters

PARAMETER MEASUREMENT INFORMATION

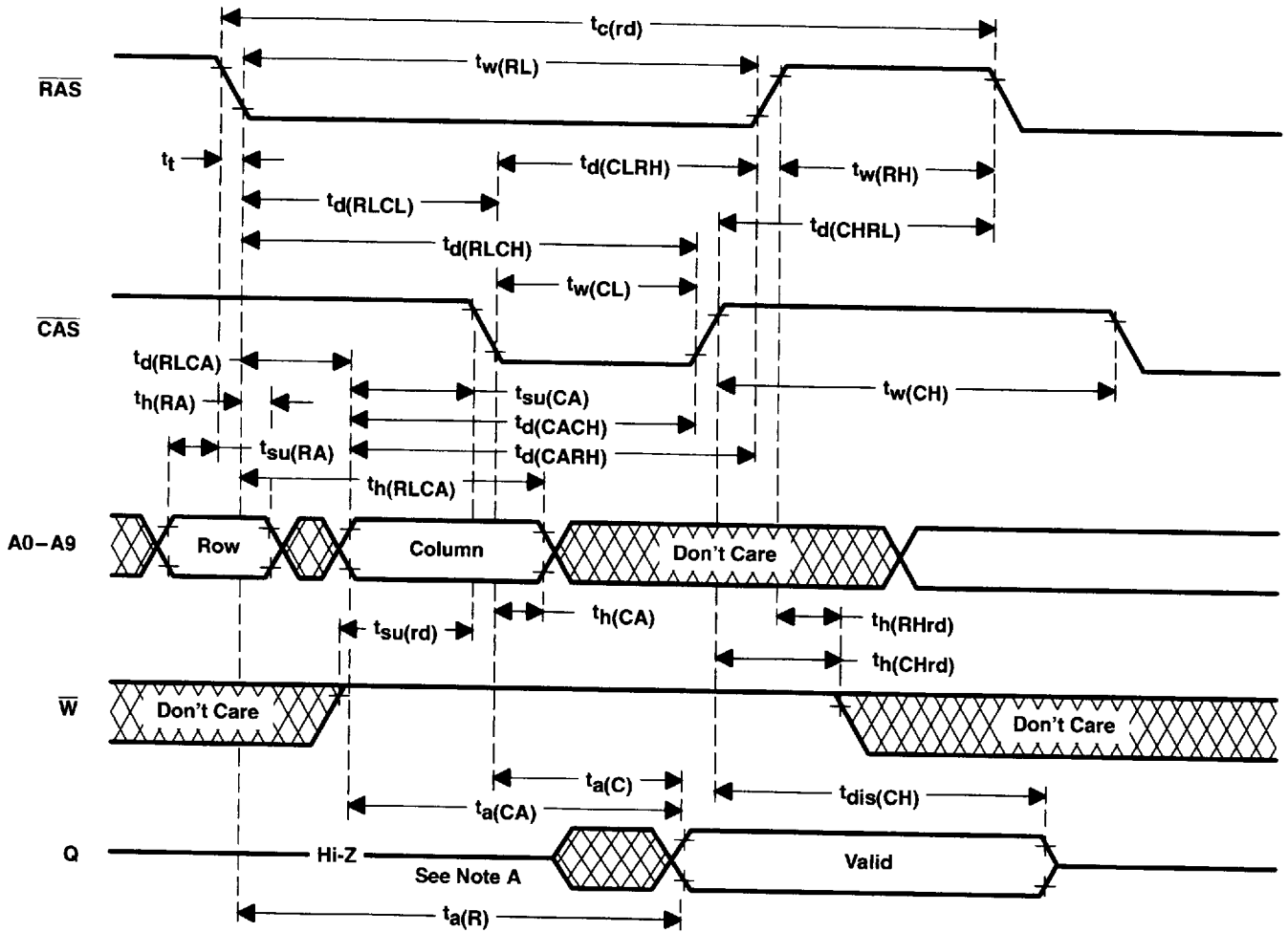

NOTE A: Output can go from the high-impedance state to an invalid-data state prior to the specified access time.

Figure 2. Read-Cycle Timing

SMJ4C1024
1048576-BIT DYNAMIC RANDOM-ACCESS MEMORY

SGMS023E - DECEMBER 1988 - REVISED MARCH 1996

PARAMETER MEASUREMENT INFORMATION

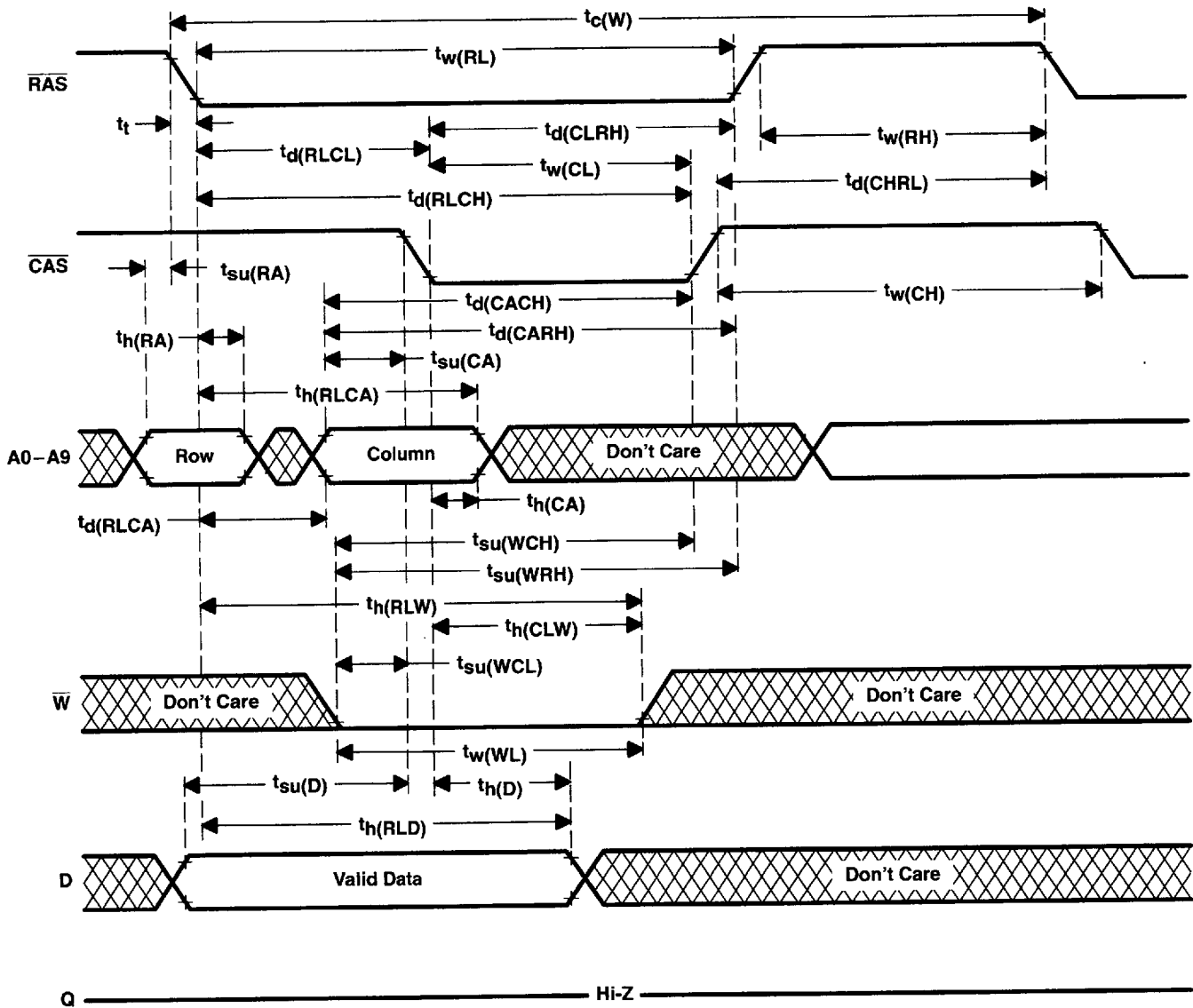

Figure 3. Early-Write-Cycle Timing

PARAMETER MEASUREMENT INFORMATION

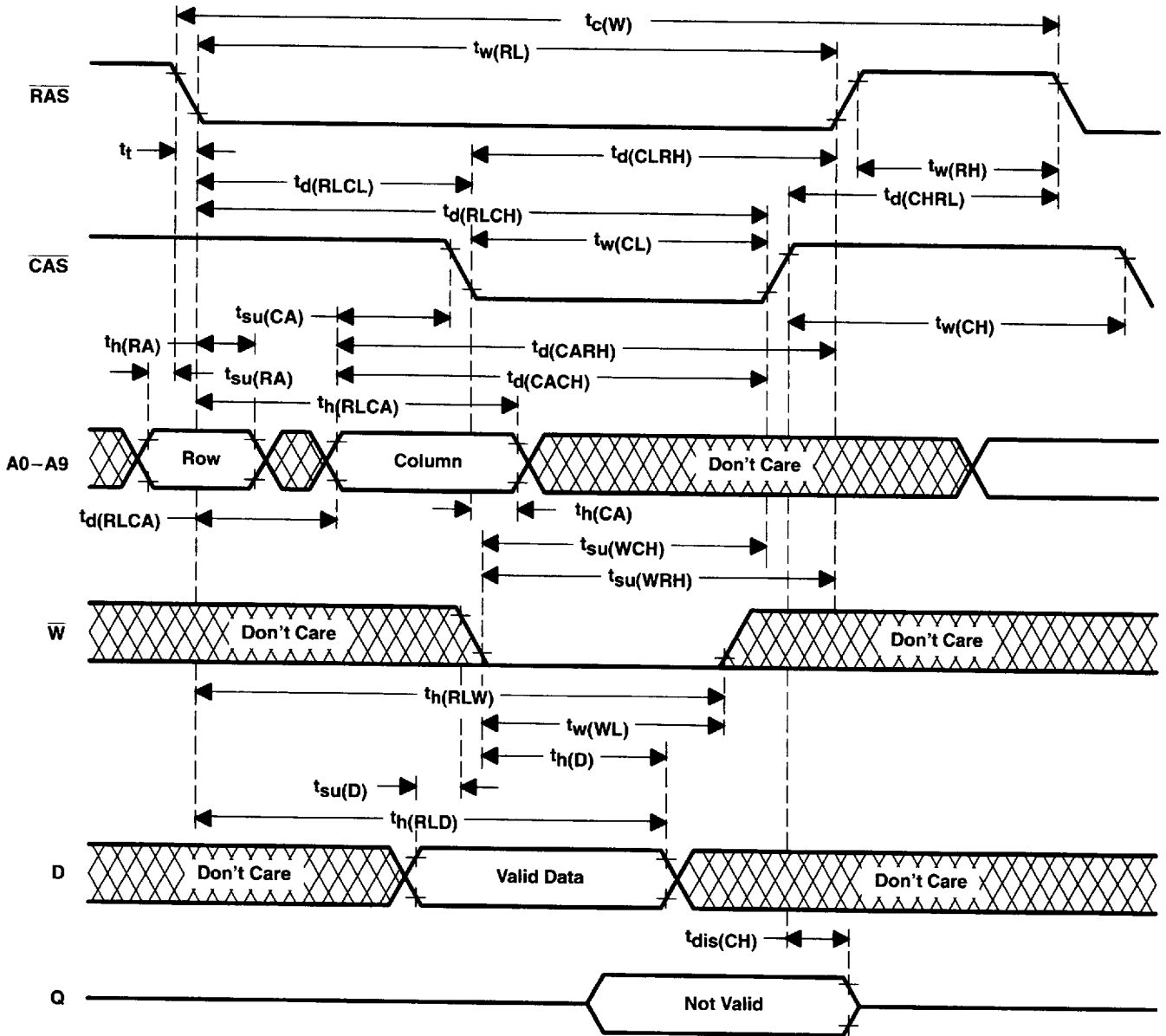
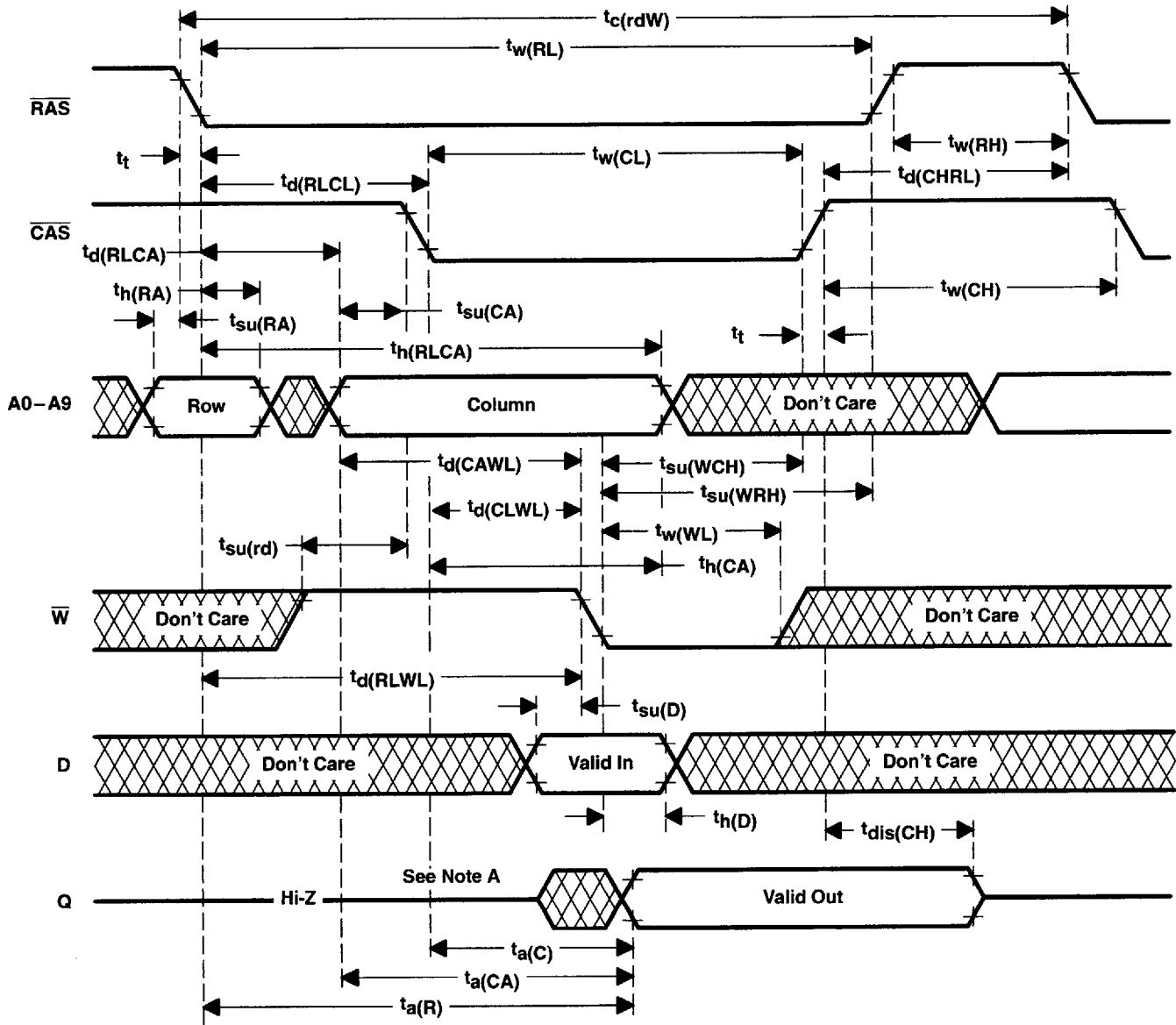

Figure 4. Write-Cycle Timing

SMJ4C1024 1048576-BIT DYNAMIC RANDOM-ACCESS MEMORY

SGMS023E - DECEMBER 1988 - REVISED MARCH 1996

PARAMETER MEASUREMENT INFORMATION



NOTE A: Output can go from the high-impedance state to an invalid-data state prior to the specified access time.

Figure 5. Read-Write-/Read-Modify-Write-Cycle Timing

PARAMETER MEASUREMENT INFORMATION

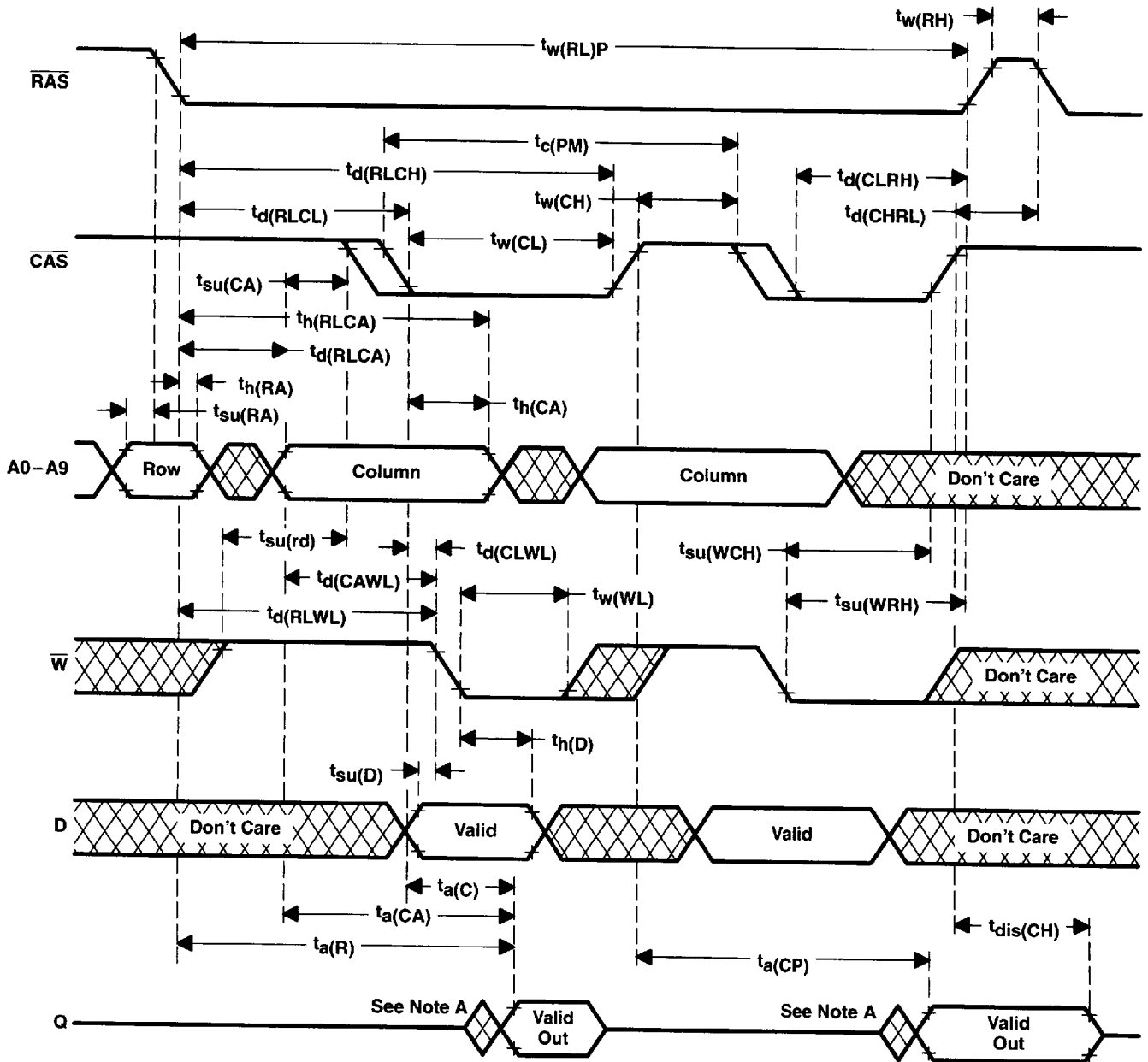

- NOTES: A. Output can go from high-impedance state to an invalid-data state prior to the specified access time.
 B. A read or a write cycle can be intermixed with read-modify-write cycles as long as the read and write timing specifications are not violated.

Figure 8. Enhanced-Page-Mode Read-Modify-Write Cycle Timing

SMJ4C1024
1048576-BIT DYNAMIC RANDOM-ACCESS MEMORY

SGMS023E - DECEMBER 1988 - REVISED MARCH 1996

PARAMETER MEASUREMENT INFORMATION

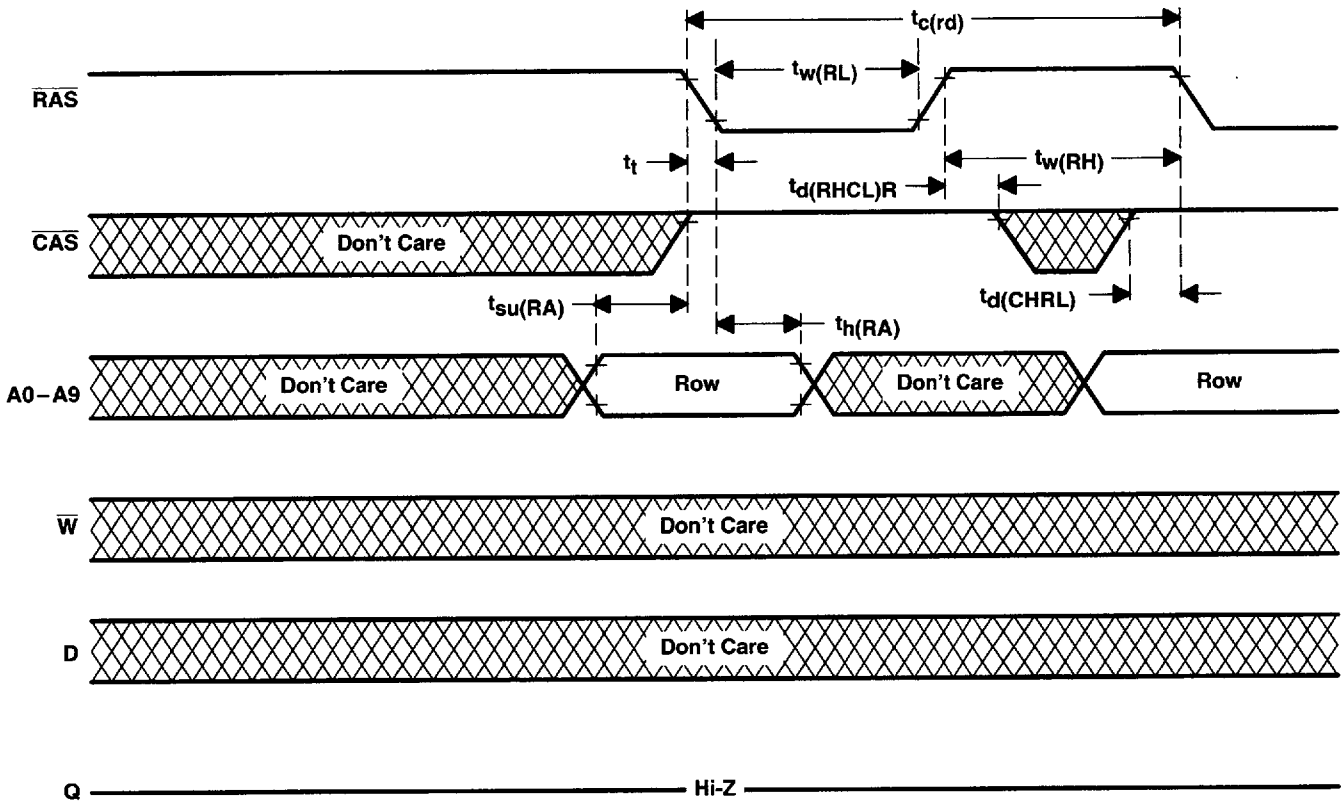

Figure 9. \overline{RAS} -Only Refresh-Cycle Timing

8961725 0086502 76T



POST OFFICE BOX 655303 • DALLAS, TEXAS 75265
 POST OFFICE BOX 1443 • HOUSTON, TEXAS 77251-1443

PARAMETER MEASUREMENT INFORMATION

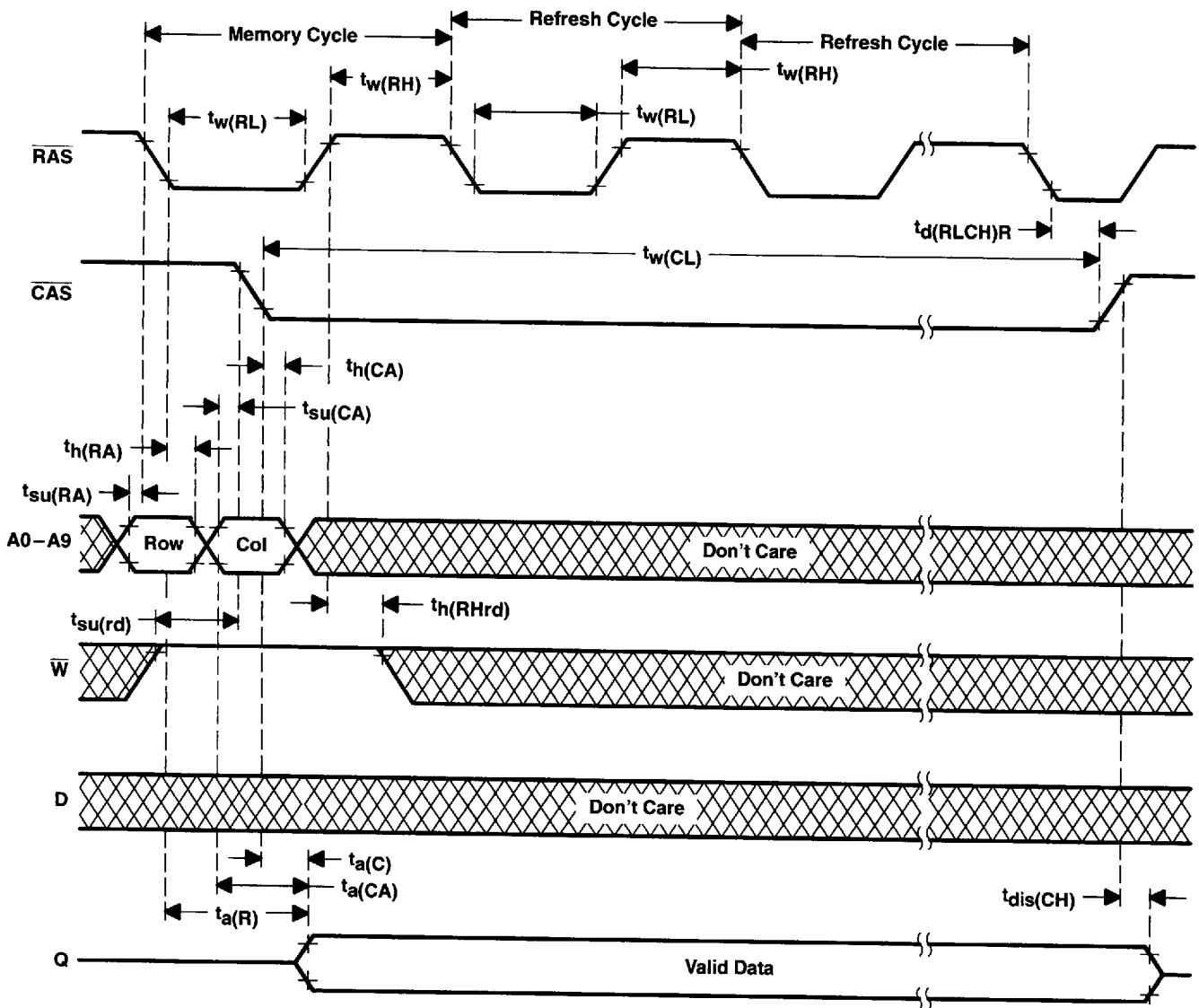

Figure 10. Hidden-Refresh-Cycle Timing

SMJ4C1024
1 048576-BIT DYNAMIC RANDOM-ACCESS MEMORY

SGMS023E - DECEMBER 1988 - REVISED MARCH 1996

PARAMETER MEASUREMENT INFORMATION

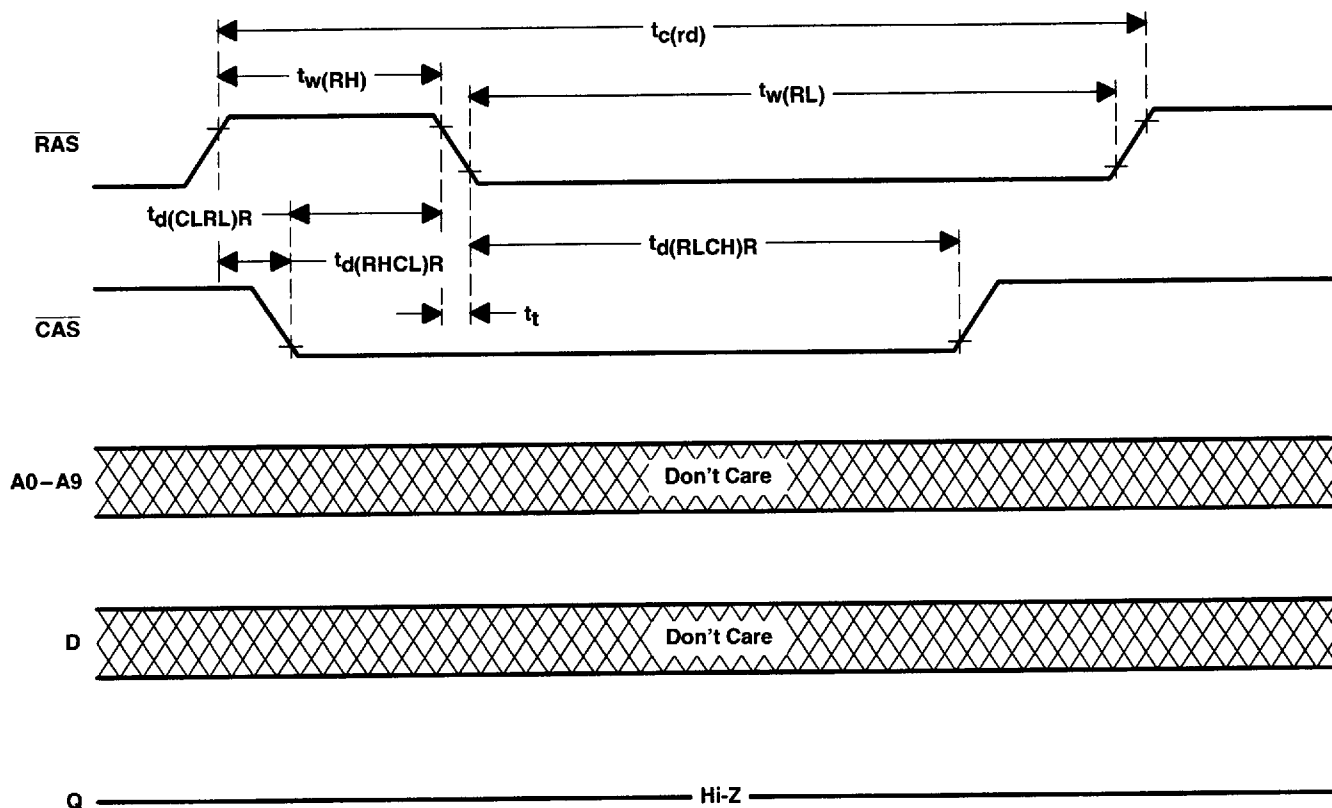

Figure 11. Automatic-CBR-Refresh-Cycle Timing

SMJ4C1024 1048576-BIT DYNAMIC RANDOM-ACCESS MEMORY

SGMS023E - DECEMBER 1988 - REVISED MARCH 1996

MECHANICAL DATA

HJ (R-CDCC-J20)

J-LEADED CERAMIC CHIP CARRIER

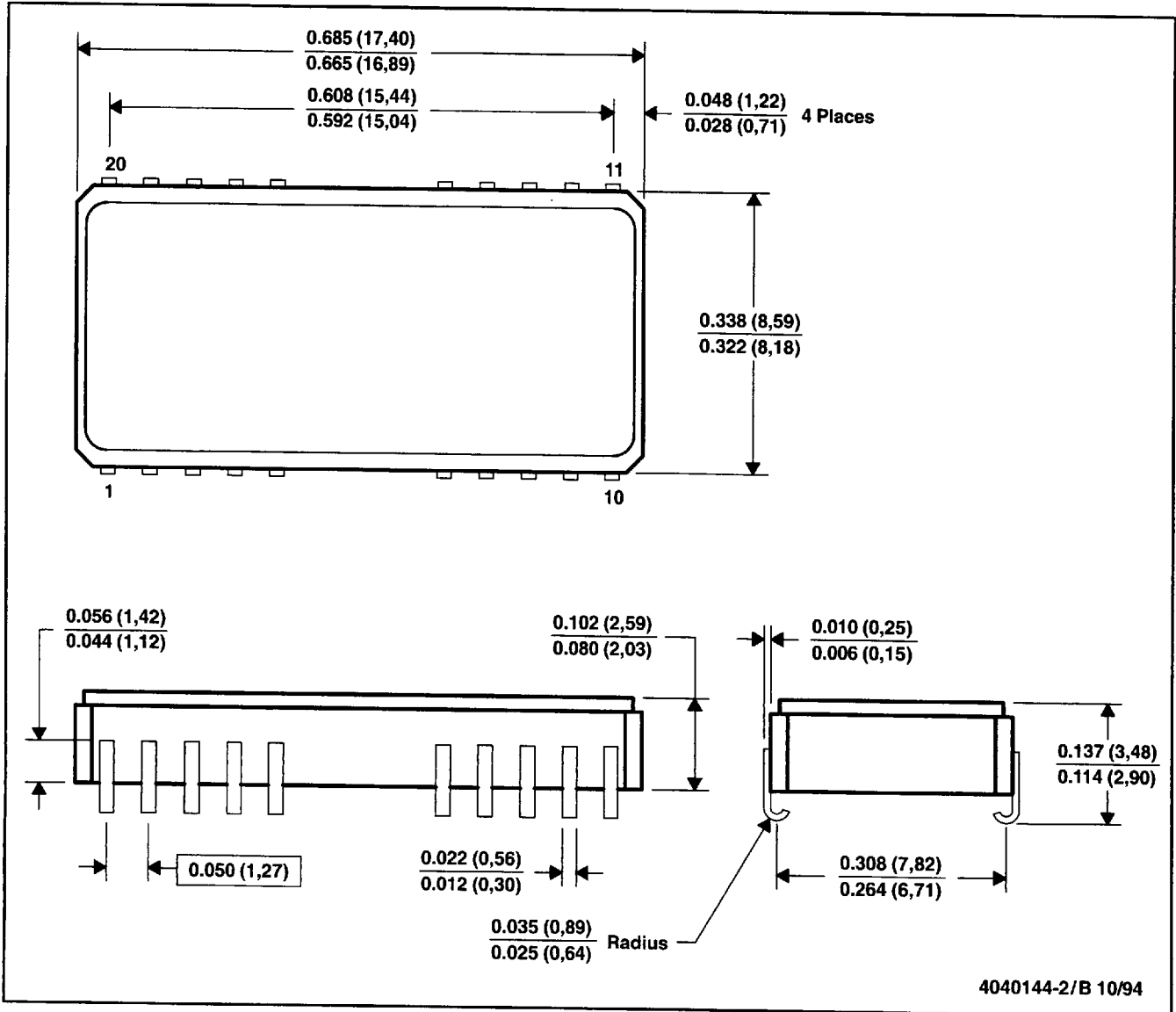

- NOTES: A. All linear dimensions are in inches (millimeters).
 B. This drawing is subject to change without notice.
 C. This package can be hermetically sealed with a metal lid.
 D. The terminals will be gold plated.

SMJ4C1024
1048576-BIT DYNAMIC RANDOM-ACCESS MEMORY

SGMS023E - DECEMBER 1988 - REVISED MARCH 1996

MECHANICAL DATA

FQ (R-CDCC-N20)

LEADLESS CERAMIC CHIP CARRIER

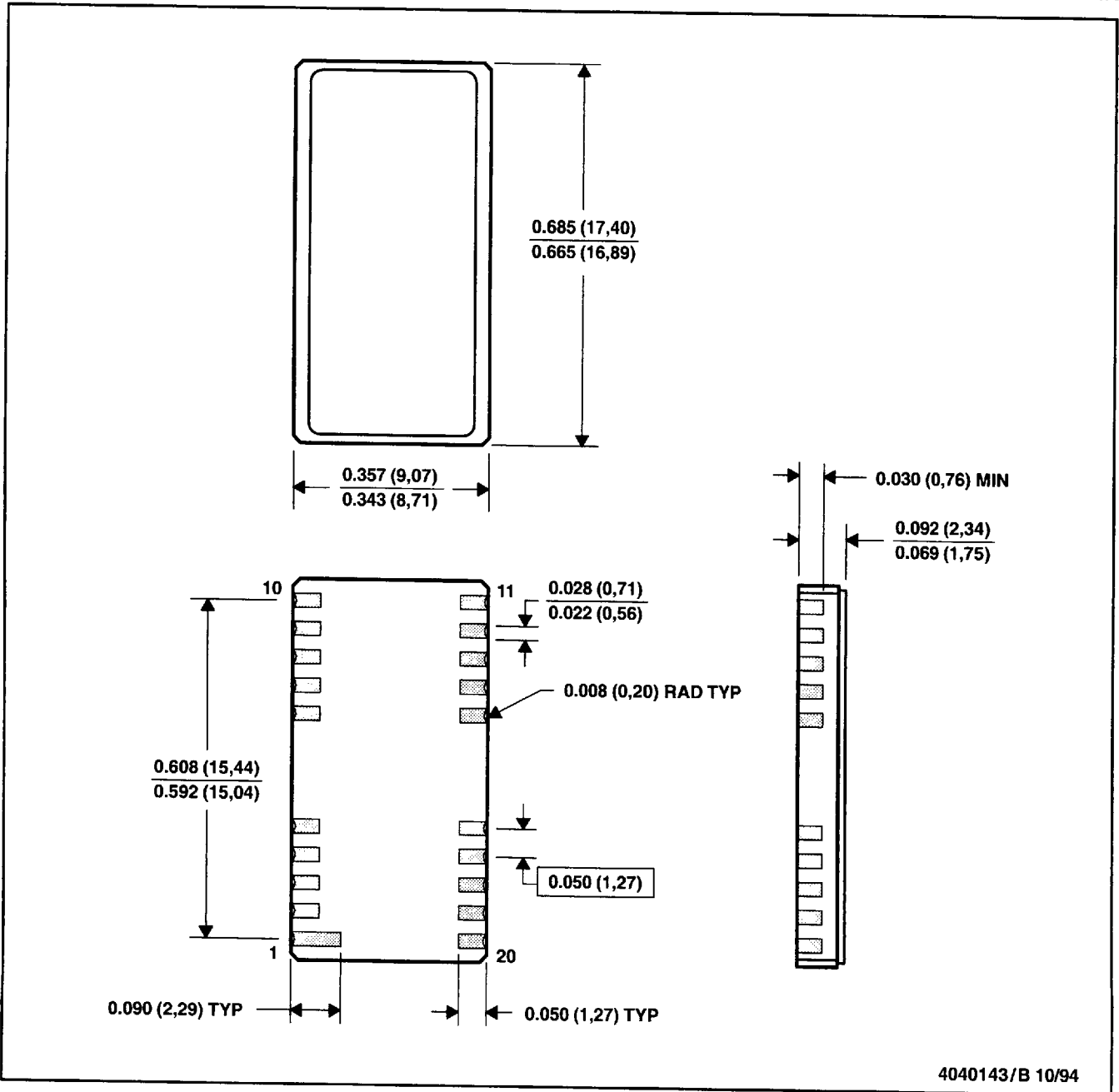

- NOTES: A. All linear dimensions are in inches (millimeters).
B. This drawing is subject to change without notice.
C. This package can be hermetically sealed with a metal lid.
D. The terminals are gold plated.

8961725 0086507 241

 TEXAS
INSTRUMENTS

POST OFFICE BOX 655303 • DALLAS, TEXAS 75265
POST OFFICE BOX 1443 • HOUSTON, TEXAS 77251-1443

SMJ4C1024
1048576-BIT DYNAMIC RANDOM-ACCESS MEMORY

SGMS023E - DECEMBER 1988 - REVISED MARCH 1996

MECHANICAL DATA

HL (R-CDCC-N20/26)

LEADLESS CERAMIC CHIP CARRIER

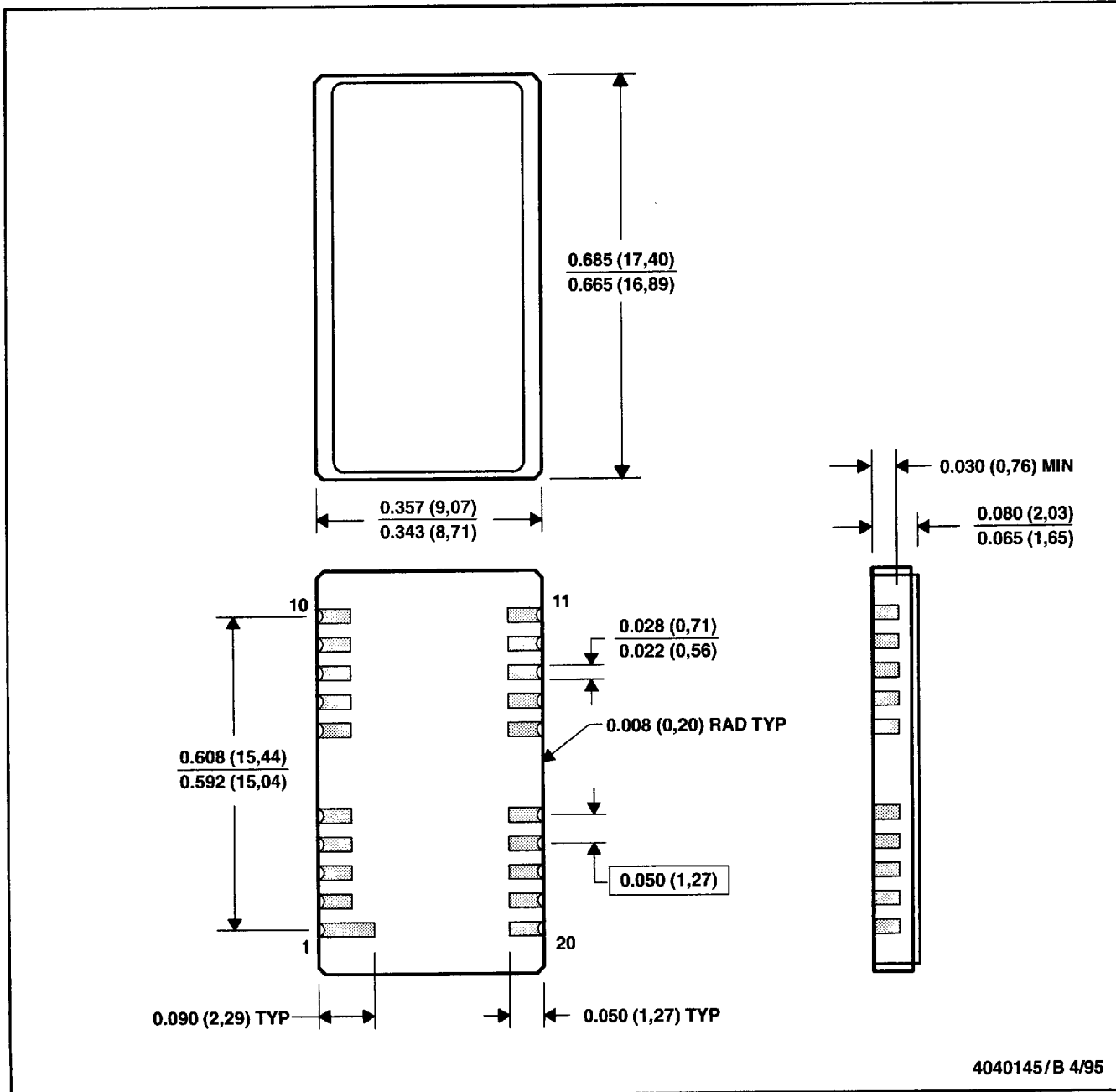

4040145/B 4/95

- NOTES: A. All linear dimensions are in inches (millimeters).
 B. This drawing is subject to change without notice.
 C. This package can be hermetically sealed with a metal lid.
 D. The terminals are gold plated.

8961725 0086508 188



POST OFFICE BOX 655303 • DALLAS, TEXAS 75265
 POST OFFICE BOX 1443 • HOUSTON, TEXAS 77251-1443

SMJ4C1024 1048576-BIT DYNAMIC RANDOM-ACCESS MEMORY

SGMS023E - DECEMBER 1988 - REVISED MARCH 1996

MECHANICAL DATA

SV (R-CZIP-T**)

CERAMIC ZIG-ZAG PACKAGE

20 PIN SHOWN

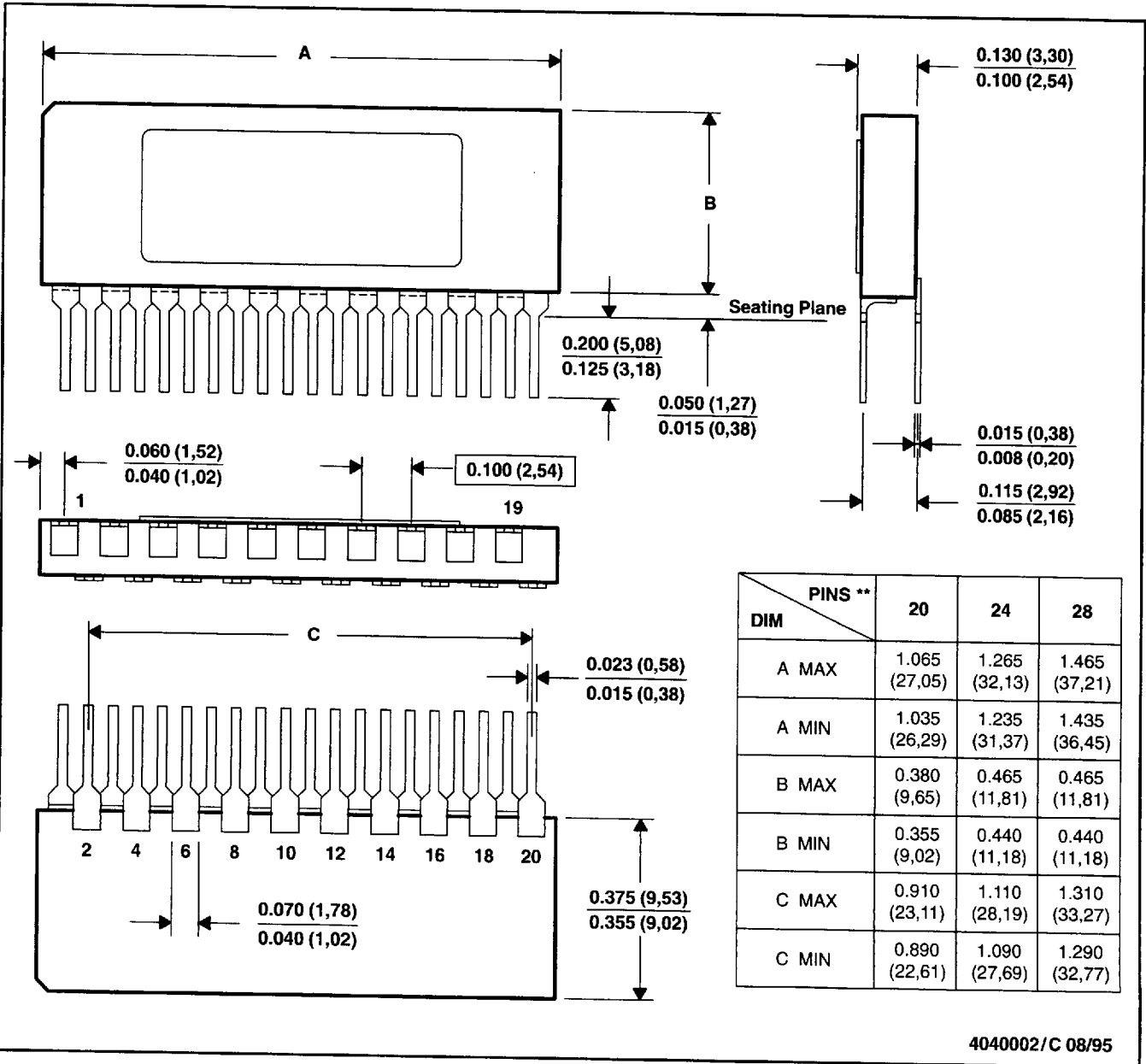

NOTES: A. All linear dimensions are in inches (millimeters).
B. This drawing is subject to change without notice.

8961725 0086509 014

**TEXAS
INSTRUMENTS**

POST OFFICE BOX 655303 • DALLAS, TEXAS 75265
POST OFFICE BOX 1443 • HOUSTON, TEXAS 77251-1443

SMJ4C1024 1048576-BIT DYNAMIC RANDOM-ACCESS MEMORY

SGMS023E - DECEMBER 1988 - REVISED MARCH 1996

MECHANICAL DATA

JD (R-CDIP-T**)

CERAMIC SIDE-BRAZE DUAL-IN-LINE PACKAGE

20 PIN SHOWN

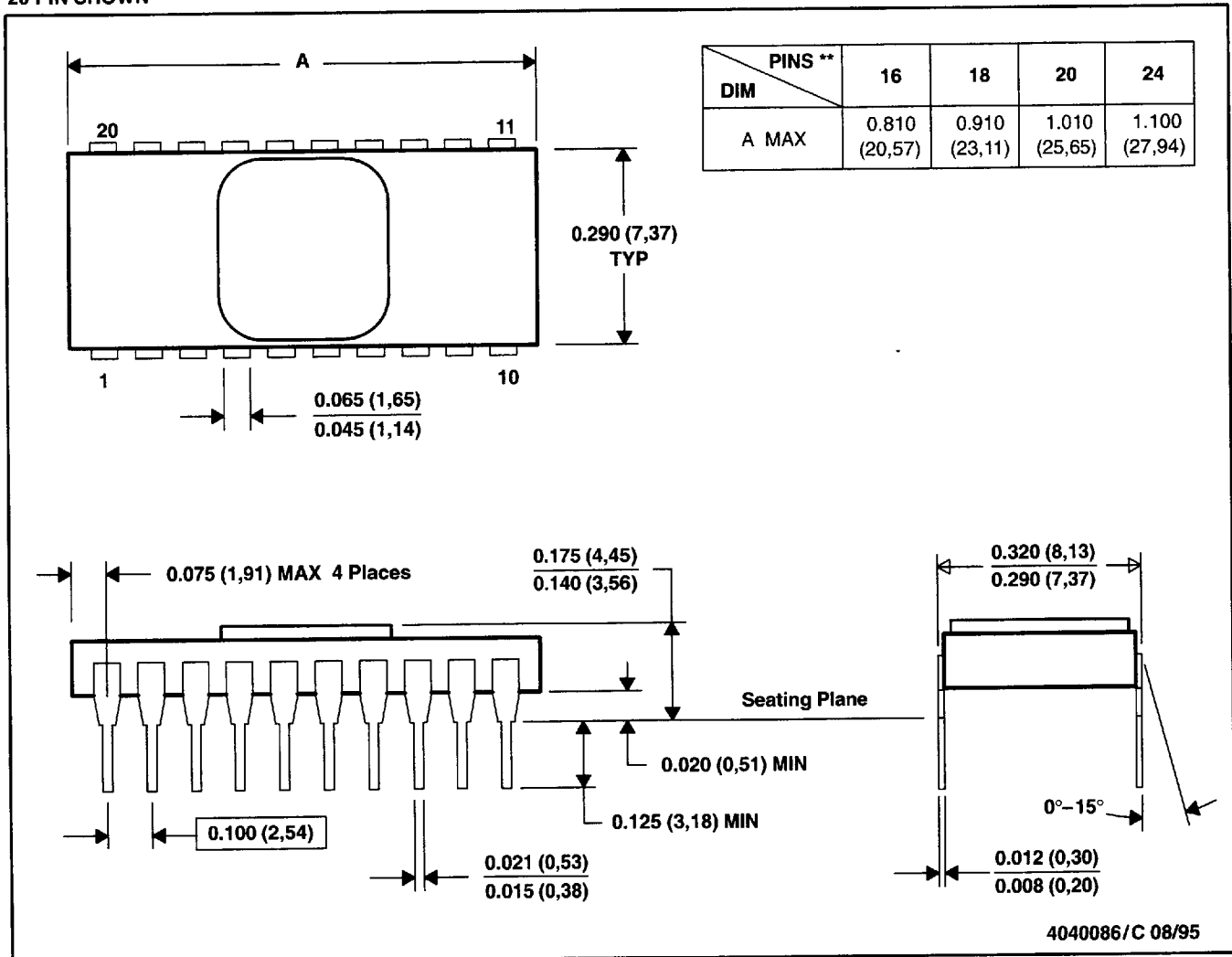

- NOTES: A. All linear dimensions are in inches (millimeters).
 B. This drawing is subject to change without notice.
 C. This package can be hermetically sealed with a metal lid.
 D. The terminals are gold plated.

8961725 0086510 836



POST OFFICE BOX 655303 • DALLAS, TEXAS 75265
 POST OFFICE BOX 1443 • HOUSTON, TEXAS 77251-1443