

CPDUR Series-HF

RoHS Device

Halogen Free



Features

- Bi-directional ESD protection
- Surface mount package.
- High component density.

Mechanical data

- Case: 0603/SOD-523F standard package, molded plastic.
- Terminals: Gold plated, solderable per MIL-STD-750, method 2026.
- Marking Code:
 - CPDUR5V0-HF: E05
 - CPDUR12V-HF: E12
 - CPDUR24V-HF: E24
- Mounting position: Any.
- Weight: 0.003 grams(approx.).

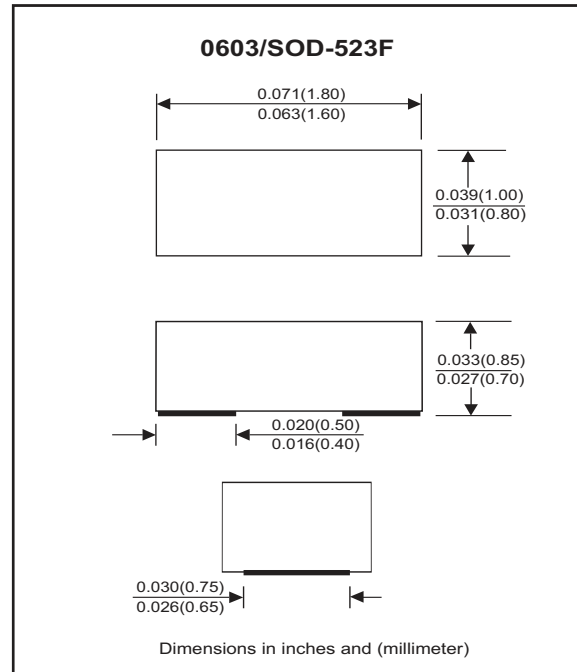

Electrical Characteristics (at TA=25°C unless otherwise noted)

Parameter		Conditions	Symbol	Min	Typ	Max	Unit
Diode breakdown voltage	CPDUR5V0-HF	I _R = 1mA	V _{BD}	5.1	7.0		V
	CPDUR12V-HF			13	17		
	CPDUR24V-HF			25	28		
Leakage current	CPDUR5V0-HF	V _R = 5V	I _L		0.1	2.0	uA
	CPDUR12V-HF	V _R = 12V					
	CPDUR24V-HF	V _R = 24V					
Junction capacitance	CPDUR5V0-HF	V _R = 0V, f = 1MHz	C _T		15	20	pF
	CPDUR12V-HF				12	-	
	CPDUR24V-HF				10	-	
ESD capability	CPDUR Series-HF	IEC 61000-4-2(air) IEC 61000-4-2(contact)	ESD			16 8	kV
Clamping voltage	CPDUR5V0-HF	I _{PP} = 1A, T _P =8/20us	V _C			10	V
	CPDUR12V-HF	I _{PP} = 5A, T _P =8/20us				15	
	CPDUR24V-HF	I _{PP} = 1A, T _P =8/20us I _{PP} = 1A, T _P =8/20us				25 47	
Peak pulse power	CPDUR5V0-HF CPDUR12V-HF CPDUR24V-HF	T _P =8/20us	P _{PP}			75 25 47	W
Operation temperature range	CPDUR Series-HF		T _j	-40		125	°C
Storage temperature range	CPDUR Series-HF		T _{STG}	-55		150	°C

Company reserves the right to improve product design , functions and reliability without notice.

REV:D

RATING AND CHARACTERISTIC CURVES (CPDUR Series-HF)

Fig.1 - Peak Pulse Current Wave
Form Acc. IEC 61000-4-5

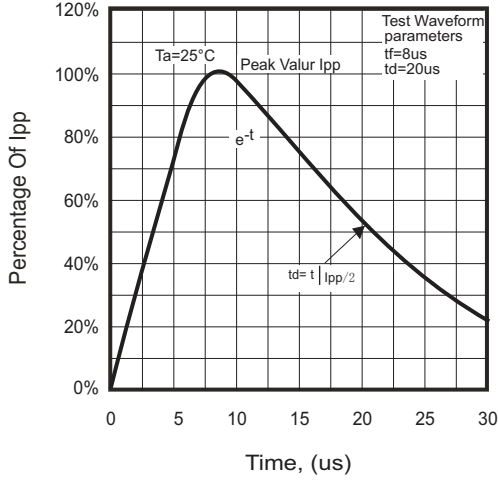

Fig.2-1 - Reverse Characteristics

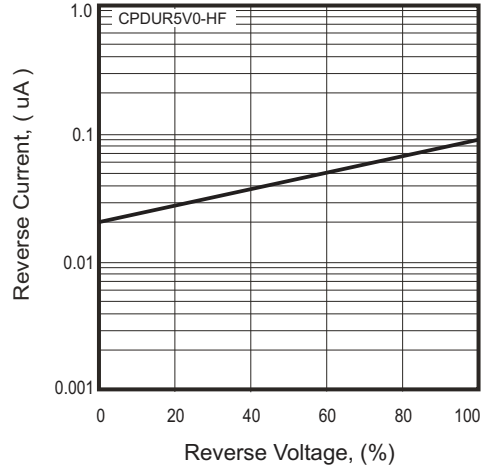

Fig.2-2 - Reverse Characteristics

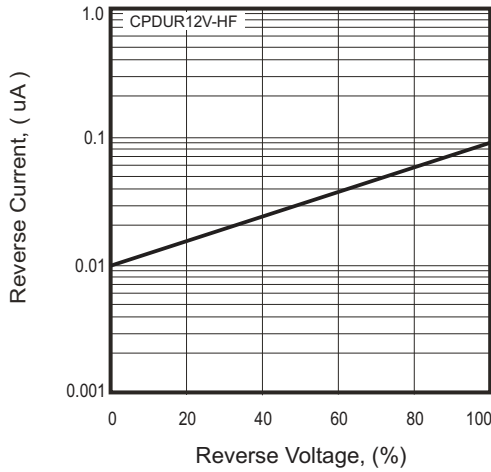

Fig.2-3 - Reverse Characteristics

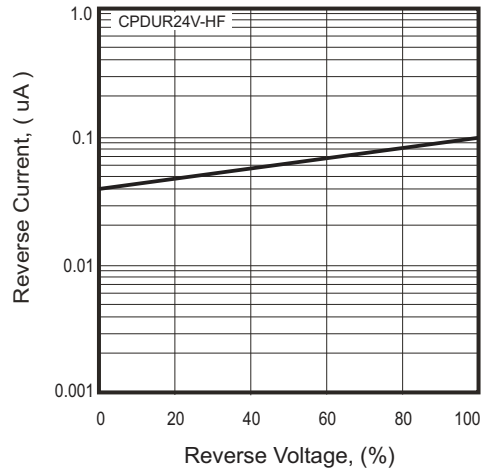

Fig.3 - Capacitance Between
Terminals Characteristics

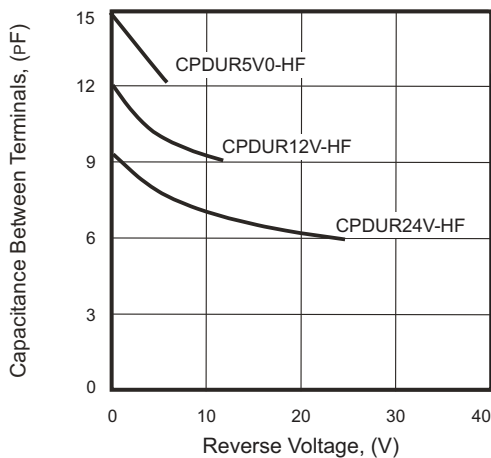
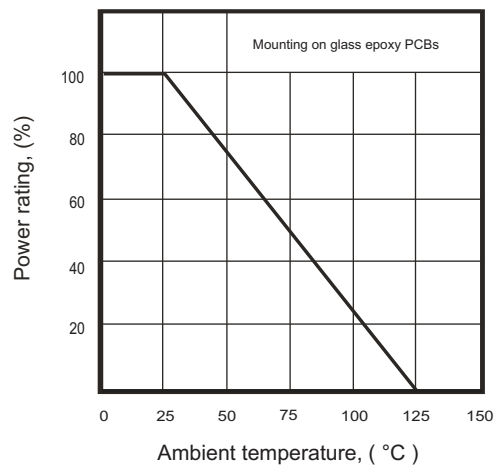
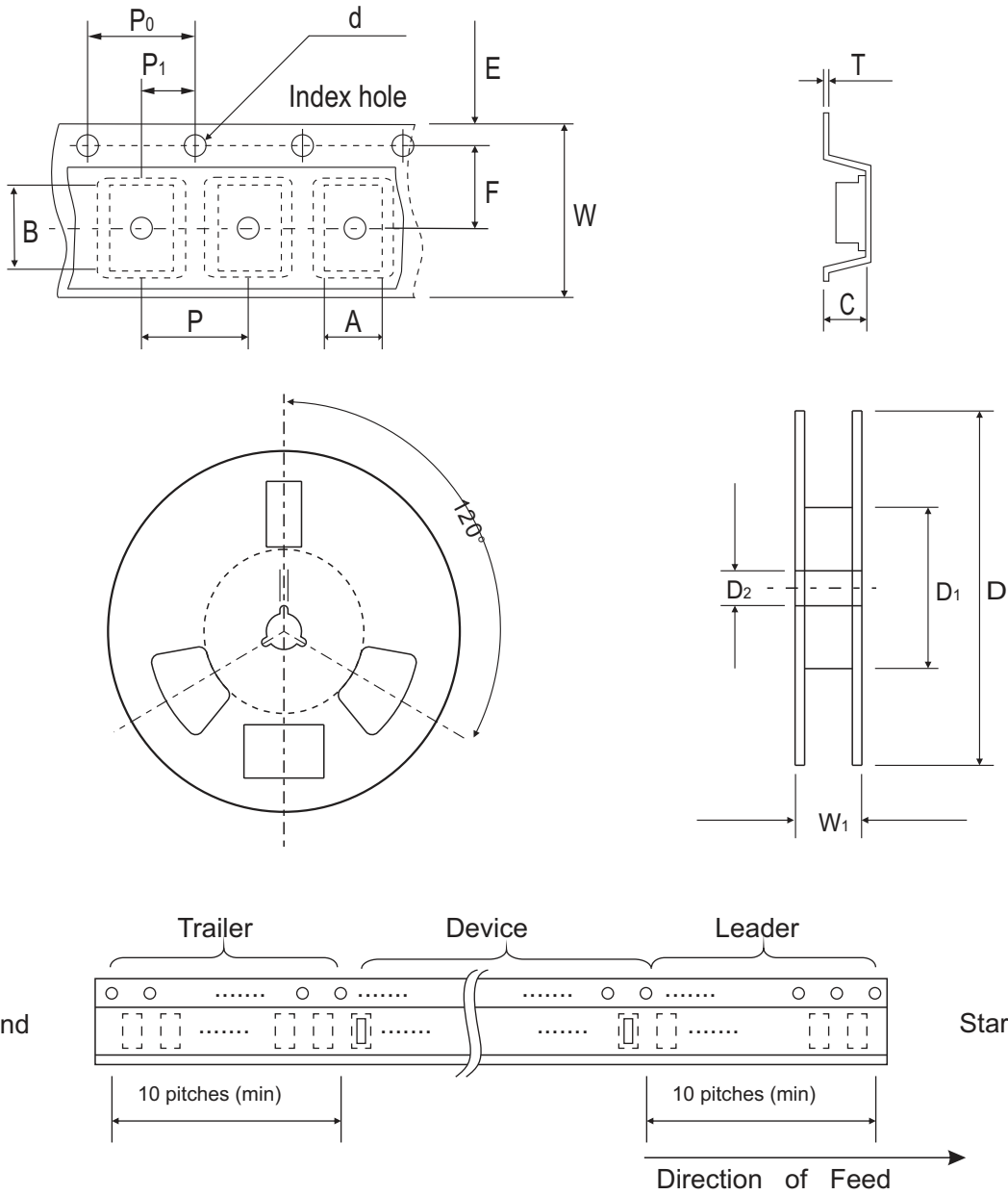

Fig. 4 - Power rating derating curve



Company reserves the right to improve product design, functions and reliability without notice.

Reel Taping Specification



0603 (SOD-523)	SYMBOL	A	B	C	d	D	D ₁	D ₂
	(mm)	1.00 ± 0.10	1.85 ± 0.10	1.00 ± 0.10	1.55 ± 0.05	178 ± 1	60.0 MIN.	13.0 ± 0.20
	(inch)	0.039 ± 0.004	0.073 ± 0.004	0.039 ± 0.004	0.061 ± 0.002	7.008 ± 0.04	2.362 MIN.	0.512 ± 0.008

0603 (SOD-523)	SYMBOL	E	F	P	P ₀	P ₁	T	W	W ₁
	(mm)	1.75 ± 0.10	3.50 ± 0.05	4.00 ± 0.10	4.00 ± 0.10	2.00 ± 0.05	0.23 ± 0.05	8.00 ± 0.20	13.5 MAX.
	(inch)	0.069 ± 0.004	0.138 ± 0.002	0.157 ± 0.004	0.157 ± 0.004	0.079 ± 0.004	0.009 ± 0.002	0.315 ± 0.008	0.531 MAX.

Company reserves the right to improve product design, functions and reliability without notice.

REV.D

Marking Code

Part Number	Marking Code
CPDUR5V0-HF	E05
CPDUR12V-HF	E12
CPDUR24V-HF	E24



xxx = Product type marking code

Suggested PAD Layout

SIZE	0603/SOD-523F	
	(mm)	(inch)
A	1.25	0.049
B	0.60	0.024
C	1.00	0.039
D	1.85	0.073
E	0.65	0.026

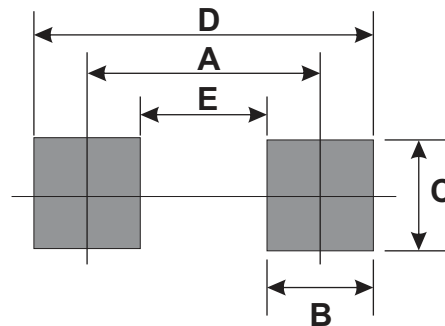

Standard Packaging

Case Type	Qty Per Reel	Reel Size
	(Pcs)	(inch)
0603/SOD-523F	4,000	7