

Single-Conversion DVB-H Tuner

General Description

The MAX2165 direct-conversion tuner IC is designed for handheld digital video broadcast (DVB-H) applications. The tuner covers a 470MHz to 780MHz input frequency range and features an I/Q baseband interface.

The MAX2165's direct-conversion architecture eliminates the need for an IF-SAW filter, allowing for reduced bill of materials cost. The design integrates a variable-gain, low-noise amplifier (LNA); a notch filter; an RF tracking filter; a quadrature mixer; a power detector; programmable baseband lowpass channel-selection filters; baseband variable-gain amplifiers (VGA); DC offset correction circuitry; and a complete fractional-N frequency synthesizer. The part is programmable through a 2-wire I²C-compatible serial interface.

The MAX2165 integrates a tuneable notch filter. This filter is designed to notch out interfering signals in the 830MHz to 950MHz frequency range to allow for operation in the presence of large cellular signals. Programmable baseband channel-selection filters allow for operation with 7MHz and 8MHz channels. Digital DC offset correction circuitry supports time-sliced operation by minimizing power-up time delay. The fractional-N synthesizer reduces VCO lock time and minimizes close-in phase noise, eliminating the need for power-hungry, phase-noise reduction algorithms.

The MAX2165 is available in a tiny, 5mm x 5mm x 0.8mm, 28-pin thin QFN package with an exposed paddle. It is specified for operation over the -40°C to +85°C extended temperature range.

Applications

DVB-H Handheld Receivers
DVB-T Portable Devices
DMB-T/H Portable Devices
ISDB-T Receivers (13 Segment)

Features

- ◆ 93mA (typ) Current Consumption from a Single +2.85V Supply Voltage
- ◆ 21mW (typ) Average Power Consumption at 8% Duty Cycle
- ◆ Direct-Conversion Architecture Eliminates IF-SAW Filter
- ◆ Integrated RF Tuneable Notch Filter for Operation in the Presence of Cellular Blockers
- ◆ Integrated DC Offset Correction Circuitry
- ◆ Integrated RF Notch Filter for Operation in the Presence of Up to -7dBm Cellular Blockers
- ◆ Extended UHF Band Operation
- ◆ 5mm x 5mm x 0.8mm, 28-Pin Thin QFN Package

Ordering Information

PART	TEMP RANGE	PIN-PACKAGE
MAX2165ETI+	-40°C to +85°C	28 TQFN-EP*

+ Denotes a lead(Pb)-free/RoHS-compliant package.

*EP = Exposed paddle.

Pin Configuration/ Functional Diagram

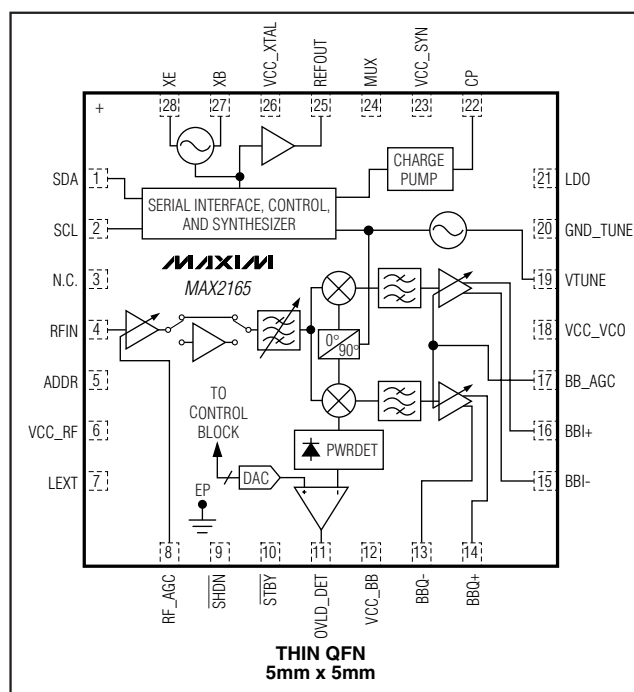

Single-Conversion DVB-H Tuner

ABSOLUTE MAXIMUM RATINGS

All V_{CC} Pins to GND-0.3V to +3.6V
 GND_TUNE to GND-0.3V to +0.3V
 All Other Pins to GND-0.3V to (V_{CC} + 0.3V)
 BBI_, BBQ_ Short Circuit to Ground DurationIndefinite
 Maximum RF Input Power+13dBm
 Continuous Power Dissipation (T_A = +70°C)
 28-Pin Thin QFN (derate 34.5mW/°C above +70°C).....2758mW

Operating Temperature Range-40°C to +85°C
 Junction Temperature+150°C
 Storage Temperature Range-65°C to +150°C
 Lead Temperature (soldering, 10s)+300°C

Stresses beyond those listed under "Absolute Maximum Ratings" may cause permanent damage to the device. These are stress ratings only, and functional operation of the device at these or any other conditions beyond those indicated in the operational sections of the specifications is not implied. Exposure to absolute maximum rating conditions for extended periods may affect device reliability.



CAUTION! ESD SENSITIVE DEVICE

DC ELECTRICAL CHARACTERISTICS

(MAX2165 EV kit, V_{CC} = +2.75V to +3.3V, V_{RF_AGC} = V_{BB_AGC} = 2.3V (maximum gain), no RF input signals at RFIN, default register settings, T_A = -40°C to +85°C, unless otherwise noted. Typical values are at V_{CC} = +2.85V, T_A = +25°C, unless otherwise noted.) (Note 1)

PARAMETER	CONDITIONS	MIN	TYP	MAX	UNITS
SUPPLY VOLTAGE AND CURRENT					
Supply Voltage		2.75		3.30	V
Supply Current	LNASW = 1 (RF LNA on)		109	134	mA
	LNASW = 0 (RF LNA off)		93	116	
Shutdown Current				20	μA
Gain-Control Voltage	Required to obtain full range of RF and baseband gain	0.4		2.3	V
RF_AGC and BB_AGC Input Bias Current	V _{AGC} at +0.4V and +2.3V	-50		+50	μA
SERIAL INTERFACE					
Input Logic-Level Low				0.3 x V _{CC}	V
Input Logic-Level High		0.7 x V _{CC}			V
Input Hysteresis			0.05 x V _{CC}		V
SDA, SCL Input Current		-10		+10	μA
Output Logic-Level Low	I _{SINK} = 0.3mA			0.4	V
Output Logic-Level High	I _{SOURCE} = 0.3mA	V _{CC} - 0.4			V

AC ELECTRICAL CHARACTERISTICS

(MAX2165 EV kit, V_{CC} = +2.75V to +3.3V, V_{RF_AGC} = V_{BB_AGC} = 2.3V (maximum gain), V_{OUT} = 1V_{p-p}, 75Ω system impedance, registers set according to the specified default register conditions, T_A = -40°C to +85°C, unless otherwise noted. Typical values are at V_{CC} = +2.85V, T_A = +25°C, unless otherwise noted.) (Note 1)

PARAMETER	CONDITIONS	MIN	TYP	MAX	UNITS
OVERALL PERFORMANCE (RF INPUT TO BASEBAND OUTPUTS)					
Operating Frequency Range	Meets specified performance	470		783	MHz
	Operates with derated performance (Note 2)	470		832	
Input Return Loss	50Ω system, worst case across band, any gain-control setting (Note 3)	7			dB

Single-Conversion DVB-H Tuner

MAX2165

AC ELECTRICAL CHARACTERISTICS (continued)

(MAX2165 EV kit, $V_{CC} = +2.75V$ to $+3.3V$, $V_{RF_AGC} = V_{BB_AGC} = 2.3V$ (maximum gain), $V_{OUT} = 1V_{P-P}$, 75Ω system impedance, registers set according to the specified default register conditions, $T_A = -40^\circ C$ to $+85^\circ C$, unless otherwise noted. Typical values are at $V_{CC} = +2.85V$, $T_A = +25^\circ C$, unless otherwise noted.) (Note 1)

PARAMETER	CONDITIONS	MIN	TYP	MAX	UNITS
Voltage Gain	$Z_{SOURCE} = 75\Omega$, $Z_{LOAD} > 1k\Omega$	Maximum gain	74	82	dB
		Minimum gain on (LNASW = 1)		23 29	
RF Gain-Control Range	$0.4V \leq V_{RF_AGC} \leq 2.3V$	29	34		dB
Baseband Gain-Control Range	$0.4V \leq V_{BB_AGC} \leq 2.3V$	21	25		dB
LNA Gain Step	Gain change caused by switching RF LNA on (LNASW = 1) and off (LNASW = 0)	13.5	17		dB
LNA Gain Step Phase Change	Phase change caused by switching RF LNA on (LNASW = 1) and off (LNASW = 0)		10		degrees
Noise Figure (Note 3)	At 470MHz		3.8	6.5	dB
	At 783MHz		4.0	6.5	
Input IP2 (Note 4)	Maximum gain	0	9		dBm
	23dB gain reduction		26		
Input IP3 (Note 5)	Maximum gain	-20	-4		dBm
	23dB gain reduction		17		
In-Band Input P_{1dB}	Maximum gain (Note 6)	-22			dBm
Cellular Blocker Desensitization (Note 7)	Cellular Tx blocker gain compression		1.2	3	dB
	Cellular Tx blocker noise figure rise		3		
In-Band IM3	Two tones (782.8MHz and 782.3MHz) within passband of baseband filter, 780MHz LO frequency		-55	-40	dBc
RF Beats Converted to Output	170MHz to 960MHz RF input frequency		< -60		dBc
	960MHz to 1400MHz RF input frequency		< -60		
RF Isolation	DC to 50MHz, RF input to baseband outputs relative to desired channel		-60		dBc
I/Q Output Swing	$Z_{LOAD} = 10k\Omega \parallel 10pF$		0.5	1	V_{P-P}
I/Q DC Voltage	I+, I-, Q+, Q- outputs to ground		$V_{CC} / 2$		V
I/Q Quadrature Accuracy	Phase error			2	degrees
	Amplitude error	-1.5		+1.5	dB
Spurious Emissions at RF Input (Note 3)	50MHz to 470MHz		-38	-33	dBmV
	470MHz to 878MHz		-52	-35	
	878MHz to 1732MHz		-49	-35	
	Spur at four times Rx frequency, tested at $f_{LO} = 474MHz$, $f_{SPUR} = 1896MHz$		-58	-51	dBm
Closed-Loop Phase Noise	1kHz offset to 10kHz (Note 3)	-86	-96		dBc/Hz
	1MHz offset (Note 3)	-108	-126		
	> 10MHz offset		-140		

Single-Conversion DVB-H Tuner

AC ELECTRICAL CHARACTERISTICS (continued)

(MAX2165 EV kit, $V_{CC} = +2.75V$ to $+3.3V$, $V_{RF_AGC} = V_{BB_AGC} = 2.3V$ (maximum gain), $V_{OUT} = 1V_{P-P}$, 75Ω system impedance, registers set according to the specified default register conditions, $T_A = -40^\circ C$ to $+85^\circ C$, unless otherwise noted. Typical values are at $V_{CC} = +2.85V$, $T_A = +25^\circ C$, unless otherwise noted.) (Note 1)

PARAMETER	CONDITIONS	MIN	TYP	MAX	UNITS
Power-Up Time	Shutdown to full operation, VCO settled to the Rx frequency, DC offset calibrated (Note 8)		< 1	20	ms
BASEBAND FILTERS					
Passband Cutoff Attenuation	Lower corner (Note 9)		0 or 200		Hz
	Upper corner at 3.85MHz (UHF mode), $T_A = +25^\circ C$		0.9	5	dB
	Upper corner at 3.35MHz (VHF mode), $T_A = +25^\circ C$		2.7	5	
Amplitude Ripple	$T_A = +25^\circ C$		0.5	1.5	dB _{P-P}
Group Delay Ripple			150		μ SP-P
Group Delay Matching			5		ns
Rejection Ratio (Note 10)	4.75MHz (VHF mode) (Note 11)	23			dB
	5.25MHz (UHF mode) (Note 11)	23			
	14.5MHz (VHF and UHF mode) (Note 12)	59	75		
	> 16.2MHz		84		
FRACTIONAL SYNTHESIZER					
RF N-Divider Ratio		7		251	
RF R-Divider Ratio		1		2	
Fractional Ratio	Length of fractional accumulator (Note 13)		20		bits
Integer Spurs	Worst-case spur inside baseband filter bandwidth		-60		dBc
Settling Time	35MHz step, settled to within 100Hz frequency error / 20° phase error		200		μ s
Charge-Pump Current	ICP = 0		0.6		mA
	ICP = 1		1.2		
Charge-Pump Leakage		-10		+10	μ A
REFERENCE OSCILLATOR					
Reference Frequency		4		26	MHz
Reference Buffer Output Voltage Swing	10k Ω 10pF load	0.5	1		V _{P-P}
Input Impedance	When used as a passive input for an external reference oscillator		12		k Ω
Input Voltage	When used as a passive input for an external reference oscillator	100		600	mV _{RMS}
OVERLOAD DETECTOR					
Attack-Point Accuracy			± 2.5		dB
Attack-Point Increment	3-bit DAC, change per LSB step		2.5		dB
Detector Output Sink	Detector on	0.1			mA
	Detector off			5	μ A

Single-Conversion DVB-H Tuner

AC ELECTRICAL CHARACTERISTICS (continued)

(MAX2165 EV kit, $V_{CC} = +2.75V$ to $+3.3V$, $V_{RF_AGC} = V_{BB_AGC} = 2.3V$ (maximum gain), $V_{OUT} = 1V_{P-P}$, 75Ω system impedance, registers set according to the specified default register conditions, $T_A = -40^\circ C$ to $+85^\circ C$, unless otherwise noted. Typical values are at $V_{CC} = +2.85V$, $T_A = +25^\circ C$, unless otherwise noted.) (Note 1)

PARAMETER	CONDITIONS	MIN	TYP	MAX	UNITS
Detector Gain			150		V/V
Detector Response Time			5		μs
2-WIRE SERIAL INTERFACE					
Clock Rate	I ² C fast mode, slave category			400	kHz

- Note 1:** Min and max limits are guaranteed by test at $T_A = +25^\circ C$ and are guaranteed by design and characterization at $T_A = -40^\circ C$ and $+85^\circ C$. The default register settings are not production tested. Load registers no sooner than $100\mu s$ after power-up.
- Note 2:** Notch filter must be disabled by programming the TF_NTCH[3:0] bits to 1111 to enable operation up to 832MHz. Under extreme conditions, the part can experience up to 3dB degradation in sensitivity and intermodulation distortion.
- Note 3:** Guaranteed by design and characterization over the specified operating conditions. Not production tested.
- Note 4:** UHF tones resulting in $f_1 - f_2$ beat frequency within the baseband output. Two tones at 350MHz and 1133MHz with IM2 measured at 783MHz.
- Note 5:** Two tones converted to 5.25MHz and 10.75MHz, IM3 measured at 250kHz.
- Note 6:** A desired signal at $P_{DESIRED} = -78dBm$ is injected and downconverted to 3.75MHz. A blocker tone is injected at 10MHz higher in frequency. Specified level is blocker power at which desired output signal compresses by 1dB. $T_A = +25^\circ C$.
- Note 7:** A single blocker at -7dBm with a bandwidth of less than 4MHz is injected at 880MHz with the receiver tuned to 783MHz and set to maximum gain.
- Note 8:** VCO locked to within 100Hz of the Rx frequency. Wake-up initiated by toggling the \overline{SHDN} pin from low to high and connecting the \overline{STBY} pin to ground.
- Note 9:** Applies to continuous DC correction operation (DVB-T mode). In DVB-H mode, optional correction hold feature allows quasi-DC-coupling.
- Note 10:** Depends on 7MHz/8MHz bandwidth mode.
- Note 11:** Equivalent to video carrier in upper adjacent channel. $T_A = +25^\circ C$.
- Note 12:** Equivalent to $f_{NYQUIST} - 3.8MHz$ for 18.3MHz sampling rate baseband DAC.
- Note 13:** Total frequency resolution is $f_{REF} / 2^{20}$, or approximately 20Hz with a 20MHz reference frequency.

Typical Operating Characteristics

(MAX2165 EV kit, $V_{CC} = +2.85V$, default register settings, $V_{RF_AGC} = V_{BB_AGC} = 2.3V$, $V_{IOUT} = V_{QOUT} = 500mV_{P-P}$, $T_A = +25^\circ C$, unless otherwise noted.)

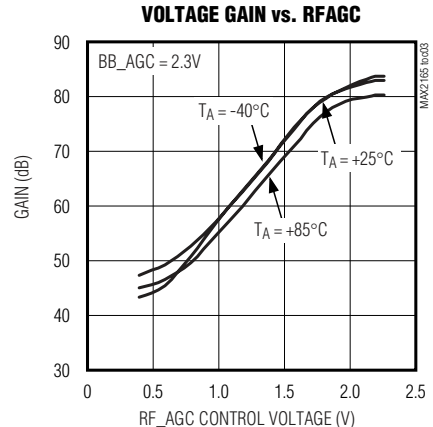
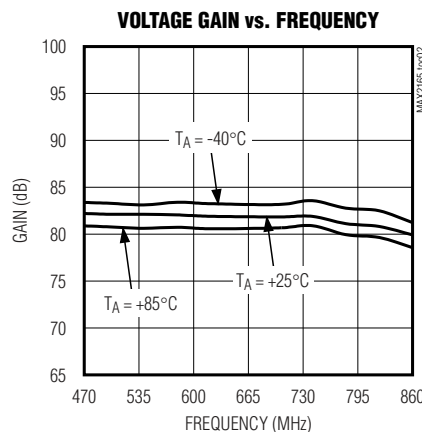
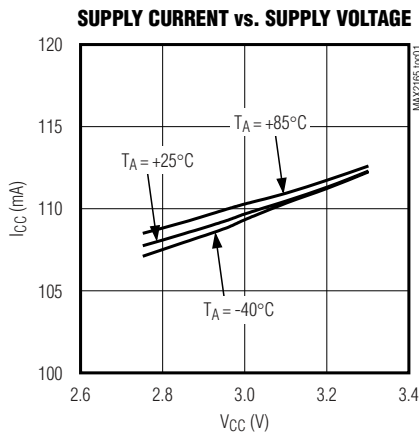

Single-Conversion DVB-H Tuner

Typical Operating Characteristics (continued)

(MAX2165 EV kit, $V_{CC} = +2.85V$, default register settings, $V_{RF_AGC} = V_{BB_AGC} = 2.3V$, $V_{IOUT} = V_{QOUT} = 500mV_{P-P}$, $T_A = +25^\circ C$, unless otherwise noted.)

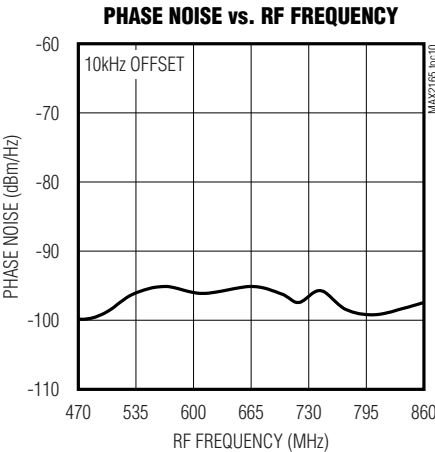
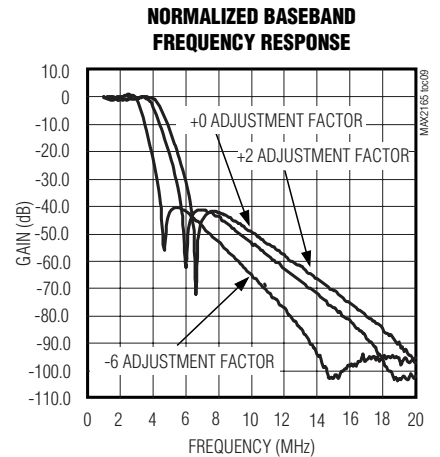
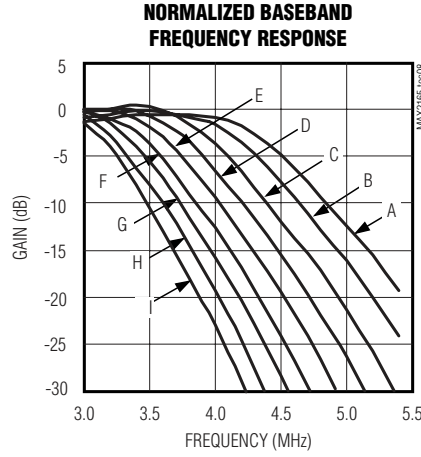
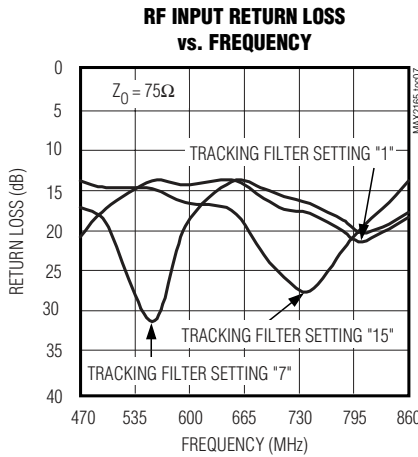
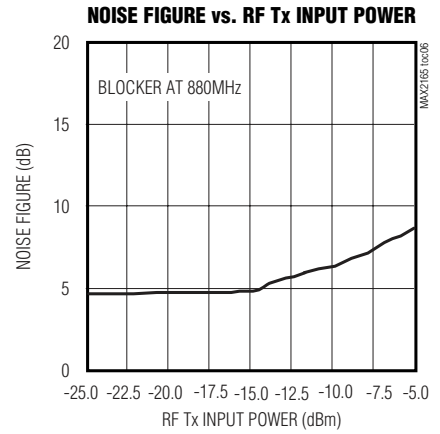
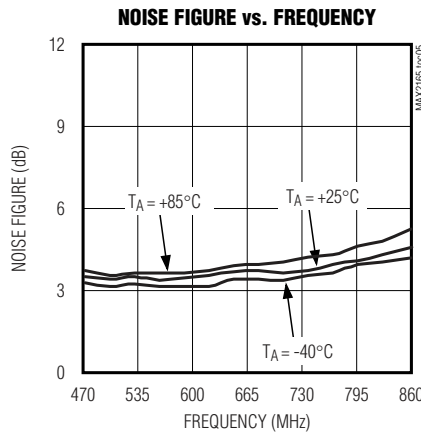
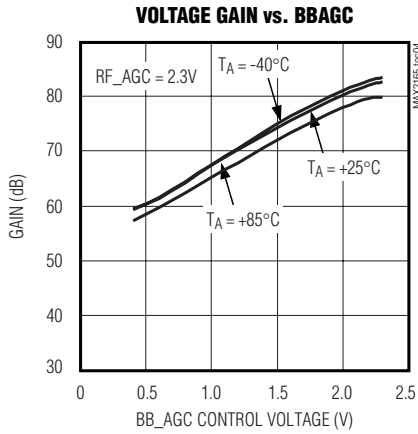

A: +2 ADJUSTMENT FACTOR F: -3 ADJUSTMENT FACTOR
 B: +1 ADJUSTMENT FACTOR G: -4 ADJUSTMENT FACTOR
 C: 0 ADJUSTMENT FACTOR H: -5 ADJUSTMENT FACTOR
 D: -1 ADJUSTMENT FACTOR I: -6 ADJUSTMENT FACTOR
 E: -2 ADJUSTMENT FACTOR

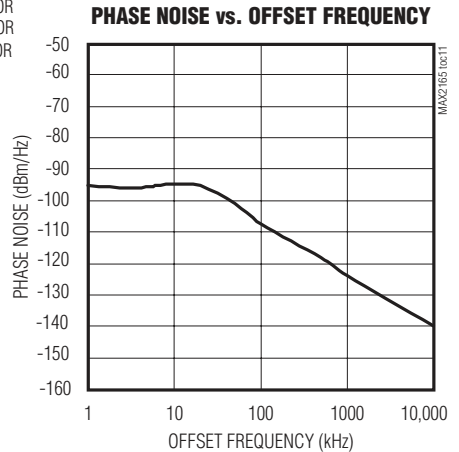

Single-Conversion DVB-H Tuner

Typical Operating Characteristics (continued)

(MAX2165 EV kit, $V_{CC} = +2.85V$, default register settings, $V_{RF_AGC} = V_{BB_AGC} = 2.3V$, $V_{IOUT} = V_{QOUT} = 500mV_{P-P}$, $T_A = +25^{\circ}C$, unless otherwise noted.)

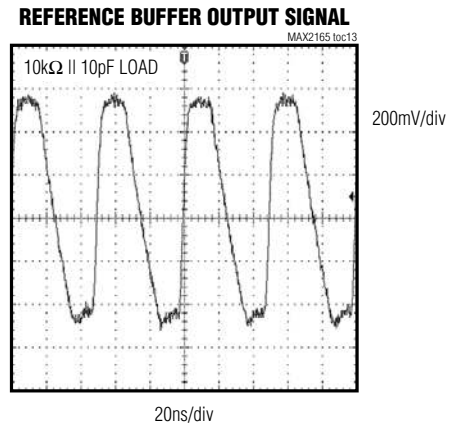
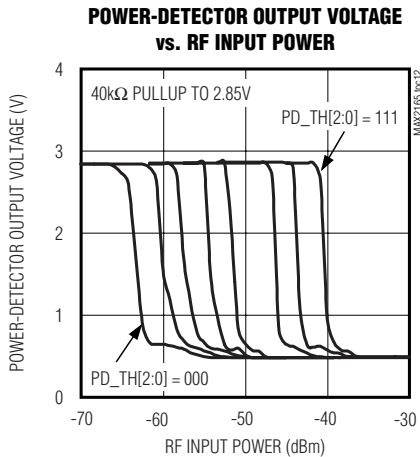

Pin Description

PIN	NAME	FUNCTION
1	SDA	Serial-Data Input/Output. Requires a pullup resistor to V_{CC} .
2	SCL	Serial-Clock Input. Requires a pullup resistor to V_{CC} .
3	N.C.	No Connection. Connect this pin to ground.
4	RFIN	RF Input. Internally matched to 75 Ω . Requires a DC-blocking capacitor.
5	ADDR	Address-Select Input. Selects the I ² C slave address. See Table 20.
6	VCC_RF	RF Power-Supply Input. Connect to a low-noise, power-supply voltage. Bypass to the PCB ground plane with a 2200pF and 100nF capacitor placed as close as possible to the pin.
7	LEXT	External Inductor Connection. Connect to V_{CC} with a 39nH inductor.
8	RF_AGC	RF Gain-Control Voltage Input. Accepts voltages from 0.4V to 2.3V with 2.3V providing maximum RF gain. This pin can also be controlled by the OVLD_DET output. See the <i>Typical Application Circuit</i> .
9	\overline{SHDN}	Shutdown Input. Drive this pin low to disable all internal circuits and to put the device into low-power shutdown mode. Drive this pin high for normal operation.
10	\overline{STBY}	Standby Input. Controls the power-up sequence of the chip. See the <i>Power-Up Sequence</i> section for more information on this pin's operation.
11	OVLD_DET	Overload-Detection Output. This output provides an error signal between the internal power-detector output voltage and an internal programmable reference voltage. This output can be connected to the RF_AGC input to implement a closed RF automatic gain-control loop.
12	VCC_BB	Baseband Power-Supply Input. Connect to a low-noise power-supply voltage. Bypass to the PCB ground plane with a 1000pF and 100nF capacitor placed as close as possible to the pin.
13	BBQ-	Inverting Quadrature Baseband Output

Single-Conversion DVB-H Tuner

Pin Description (continued)

PIN	NAME	FUNCTION
14	BBQ+	Noninverting Quadrature Baseband Output
15	BBI-	Inverting In-Phase Baseband Output
16	BBI+	Noninverting In-Phase Baseband Output
17	BB_AGC	Baseband Gain-Control Voltage Input. Accepts voltages from 0.4V to 2.3V with 2.3V providing the maximum baseband gain.
18	VCC_VCO	VCO Power-Supply Input. Connect to a low-noise power-supply voltage. Bypass to the PCB ground plane with a 1000pF and 100nF capacitor placed as close as possible to the pin.
19	VTUNE	VCO Tuning Voltage Input. Connect to the PLL loop filter output.
20	GND_TUNE	VCO Tuning Voltage Ground. Connect to the PCB ground plane.
21	LDO	VCO Linear-Regulator Noise Bypass. Bypass to the PCB ground plane with a 470nF capacitor placed as close as possible to the pin.
22	CP	Charge-Pump Output. Connect to the PLL loop filter input.
23	VCC_SYN	Synthesizer Power-Supply Input. Connect to a low-noise power-supply voltage. Bypass to the PCB ground plane with a 1000pF and 100nF capacitor placed as close as possible to the pin.
24	MUX	Multiplexed Output Line. Output for various test functions, can also be used as a PLL lock-detect indicator. See Table 9 for more information. When used as a PLL lock detector, logic-high indicates PLL is not locked and logic-low indicates PLL is locked.
25	REFOUT	Reference Buffer Output. Provides a buffered crystal-oscillator signal that can be used as a clock reference for the demodulator. Requires a DC-blocking capacitor.
26	VCC_XTAL	Crystal-Oscillator Power-Supply Input. Connect to a low-noise power-supply voltage. Bypass to the PCB ground plane with a 1000pF and 100nF capacitor placed as close as possible to the pin.
27	XB	Reference Input. Connect to a parallel resonant mode crystal through a load-matching capacitor or to a reference oscillator.
28	XE	Reference-Oscillator Feedback Input. Connect to a capacitive feedback network when the on-chip reference oscillator is used. Leave unconnected when an external reference is used.
EP	EP	Exposed Paddle. Solder evenly to the board's ground plane to achieve the lowest impedance path.

Detailed Description

Register Descriptions

The MAX2165 includes 15 programmable registers and three read-only registers. See Table 1 for register configurations. The register configuration of Table 1 shows each bit name and the bit usage information for all registers. U labeled under each bit name indicates that the bit value is user defined to meet specific application

requirements. A 0 or 1 indicates that the bit must be set to the defined 0 or 1 value for proper operation. Operation is not tested or guaranteed if these bits are programmed to other values and is only for factory/bench evaluation. In typical application, always program to the operation defined state.

See Tables 2–19 for detailed descriptions of each register. All registers must be written 100 μ s after power-up and no earlier than 100 μ s after power-up.

Single-Conversion DVB-H Tuner

MAX2165

Table 1. Register Configuration*

REGISTER NAME	REGISTER ADDRESS	REGISTER SETTINGS		DATA BYTE								MSB	LSB
		OPERATION DEFINED	DEFAULT (POR)	D7	D6	D5	D4	D3	D2	D1	D0		
N-Divider Integer	0x00	—	H17	N7 U	N6 U	N5 U	N4 U	N3 U	N2 U	N1 U	N0 U		
N-Divider Frac2	0x01	—	H18	X 0	X 0	X 0	FRAC U	F19 U	F18 U	F17 U	F16 U		
N-Divider Frac1	0x02	—	H00	F15 U	F14 U	F13 U	F12 U	F11 U	F10 U	F9 U	F8 U		
N-Divider Frac0	0x03	—	H00	F7 U	F6 U	F5 U	F4 U	F3 U	F2 U	F1 U	F0 U		
Tracking Filter	0x04	—	H72	TF_NTCH3 U	TF_NTCH2 U	TF_NTCH1 U	TF_NTCH0 U	TF_BAL3 U	TF_BAL2 U	TF_BAL1 U	TF_BAL0 U		
LNA	0x05	—	H01	X 0	X 0	X 0	X 0	X 0	X 0	X 0	LNASW U		
PLL Configuration	0x06	—	H0A	RDIV U	ICP U	CPS U	ADLY0 U	ADLY0 U	LFDIV2 U	LFDIV1 U	LFDIV0 U		
Test	0x07	—	H08	CP_TST2 0	CP_TST1 0	CP_TST0 0	X 0	X 1	LD_MUX2 U	LD_MUX1 U	LD_MUX0 U		
Shutdown	0x08	—	H00	X 0	SHDN_REF U	X 0	SHDN_SYN U	SHDN_RF U	SHDN_BB U	SHDN_PD U	SHDN_BG U		
VCO Control	0x09	—	H50	VCO1 U	VCO0 U	BS2 U	BS1 U	BS0 U	VAS 1	ADL 0	ADE 0		
Baseband Control	0x0A	—	HF3	BB_BW3 U	BB_BW2 U	BB_BW1 U	BB_BW0 U	BB_BIA0 0	PD_TH2 U	PD_TH1 U	PD_TH0 U		
DC Offset Control	0x0B	H79	H71	X 0	DC_DAC8	DC_MO1 1	DC_MO0 1	DC_SP1 1	DC_SP0 0	DC_TH1 0	DC_TH0 0		
DC Offset DAC	0x0C	H00	H00	DC_DAC7 0	DC_DAC6 0	DC_DAC5 0	DC_DAC4 0	DC_DAC3 0	DC_DAC2 0	DC_DAC1 0	DC_DAC0 0		
ROM Table Address	0x0D	—	H00	X 0	FUSE_TH 0	X 0	WR 0	TFA3 U	TFA2 U	TFA1 U	TFA0 U		
Reserved	0x0E	H00	H00	X 0	X 0	X 0	X 0	X 0	X 0	X 0	X 0		
ROM Table Data Readback	0x10	N/A	N/A	TRF7	TRF6	TRF5	TRF4	TRF3	TRF2	TRF1	TRF0		
Chip Status Readback	0x11	N/A	N/A	POR	VASA	VASE	LD	DC_LO	DC_HI	X	PD_OVLD		
Autotuner Readback	0x12	N/A	N/A	VCO1	VCO0	BS2	BS1	BS0	ADC2	ADC1	ADC0		

*See the Register Descriptions section for more information on recommended settings.

Table 2. N-Divider Integer Register (Address: 0x00)

BIT NAME	BIT LOCATION (0 = LSB)	FUNCTION
N[7:0]	7-0	Programs the integer value of the PLL N-divider ratio. Default integer divide value is 23.

Single-Conversion DVB-H Tuner

Table 3. N-Divider Frac2 Register* (Address: 0x01)

BIT NAME	BIT LOCATION (0 = LSB)	FUNCTION
X	7, 6, 5	Reserved. Set to 000 for normal operation.
FRAC	4	PLL mode select: 1 = Fractional mode selected. 0 = Integer mode selected.
F[19:16]	3–0	Sets the 4 most significant bits of the fractional PLL divider ratio.

*When programming the fractional divider ratio, all three fractional divider registers must be written before the ratio is updated.

Table 4. N-Divider Frac1 Register* (Address: 0x02)

BIT NAME	BIT LOCATION (0 = LSB)	FUNCTION
F[15:8]	7–0	Sets bits 15 through 8 of the fractional PLL divider ratio.

*When programming the fractional divider ratio, all three fractional divider registers must be written before the ratio is updated.

Table 5. N-Divider Frac0 Register* (Address: 0x03)

BIT NAME	BIT LOCATION (0 = LSB)	FUNCTION
F[7:0]	7–0	Sets the 8 least significant bits of the fractional PLL divider ratio.

*When programming the fractional divider ratio, all three fractional divider registers must be written before the ratio is updated.

Table 6. Tracking Filter Register (Address: 0x04)

BIT NAME	BIT LOCATION (0 = LSB)	FUNCTION
TF_NTCH[3:0]	7–4	Programs the notch frequency of the internal tracking filter. Optimal values for notch frequencies of 783MHz and 725MHz can be read from the ROM table entries. See the <i>Reading the ROM Table</i> section.
TF_BAL[3:0]	3–0	Programs the tracking filter balun. Optimum values over frequency can be interpolated from the ROM table entries. See the <i>Reading the ROM Table</i> section.

Table 7. LNA Register (Address: 0x05)

BIT NAME	BIT LOCATION (0 = LSB)	FUNCTION
X	7–1	Reserved. Set to all zeros for normal operation.
LNASW	0	LNA enable: 1 = LNA is enabled. 0 = LNA is disabled.

Single-Conversion DVB-H Tuner

MAX2165

Table 8. PLL Configuration Register (Address: 0x06)

BIT NAME	BIT LOCATION (0 = LSB)	FUNCTION
RDIV	7	Selects the PLL reference divider: 1 = Divide reference by 2. 0 = Divide reference by 1.
ICP	6	Selects the charge-pump current: 1 = 1.2mA 0 = 0.6mA
CPS	5	Selects how the charge-pump current is programmed: 1 = Charge-pump current is automatically programmed to the optimal setting by the VCO autotuner. 0 = Charge-pump current is set manually by programming the ICP bit.
ADLY[1:0]	4, 3	Sets the VCO autoselect wait time: 00 = ~200µs 01 = ~400µs 10 = ~800µs 11 = ~1600µs
LF_DIV[2:0]	2, 1, 0	Sets the prescaler for internal low-frequency clocks; program these bits so the crystal frequency divided by the prescaler value is equal to 2MHz: 000 = Divide by 8 (for 16MHz crystals). 001 = Divide by 9 (for 18MHz crystals). 010 = Divide by 10 (for 20MHz crystals). 011 = Divide by 11 (for 22MHz crystals). 100 = Divide by 12 (for 24MHz crystals). 101 = Divide by 13 (for 26MHz crystals). 110 = Divide by 14 (for 28MHz crystals). 111 = Divide by 2 (for 4MHz crystals).

Table 9. Test Register (Address: 0x07)

BIT NAME	BIT LOCATION (0 = LSB)	FUNCTION
CP_TST[2:0]	7, 6, 5	Charge-pump test modes: 000 = Normal operation. 100 = Force charge pump into low-impedance state. 101 = Force charge-pump source current. 110 = Force charge-pump sink current. 111 = Force charge pump into high-impedance state.
X	4, 3	Reserved. Set to 01 for normal operation.
LD_MUX[2:0]	2, 1, 0	Selects which signal is output to the MUX pin: 000 = PLL lock indicator (normal operation). 001 = N-divider output (after divide by 2). 010 = R-divider output (after divide by 2). 011 = Factory use only. 1XX = Factory use only.

Single-Conversion DVB-H Tuner

Table 10. Shutdown Register (Address: 0x08)

BIT NAME	BIT LOCATION (0 = LSB)	FUNCTION
X	7	Reserved. Set to 0 for normal operation.
SHDN_REF	6	<p>Crystal-oscillator buffer shutdown control: 1 = Buffered crystal-oscillator output is disabled. 0 = Buffered crystal-oscillator output is enabled. Note: The crystal oscillator is activated by either the SHDN_SYN bit or the SHDN_REF bit. If either bit is 0, the crystal oscillator is enabled. If both are 1, the crystal oscillator is disabled.</p>
X	5	Reserved. Set to 0 for normal operation.
SHDN_SYN	4	<p>PLL shutdown control: 1 = PLL is disabled. 0 = PLL is enabled. Note: The crystal oscillator is activated by either the SHDN_SYN bit or the SHDN_REF bit. If either bit is 0, the crystal oscillator is enabled. If both are 1, the crystal oscillator is disabled.</p>
SHDN_RF	3	<p>RF front-end shutdown control: 1 = RF circuits are disabled. 0 = RF circuits are enabled.</p>
SHDN_BB	2	<p>Mixer, baseband filters, and baseband variable-gain amplifiers (VGA) shutdown control: 1 = Mixer, baseband filters, and baseband VGA are disabled. 0 = Mixer, baseband filters, and baseband VGA are enabled.</p>
SHDN_PD	1	<p>Baseband power-detector shutdown control: 1 = Baseband power detector is disabled. 0 = Baseband power detector is enabled.</p>
SHDN_BG	0	<p>Main bias shutdown control: 1 = Main bias circuits are disabled. 0 = Main bias circuits are enabled. Note: The main bias circuits can and will be shut down once all other blocks are shut down (all bits in the Shutdown register are set to 1, and the VCO[1:0] bits in the VCO Control register and the DC_MO[1:0] in the DC Offset Control register are set to 00).</p>

Single-Conversion DVB-H Tuner

MAX2165

Table 11. VCO Control Register (Address: 0x09)

BIT NAME	BIT LOCATION (0 = LSB)	FUNCTION
VCO[1:0]	7, 6	Controls which VCO is activated when using manual VCO programming mode: 00 = VCO disabled. 01 = Select VCO 0 (lowest frequency VCO). 10 = Select VCO 1. 11 = Select VCO 2 (highest frequency VCO).
SB[2:0]	5, 4, 3	Selects which VCO sub-band is activated when using manual VCO programming mode: 000 = Select sub-band 0 (lowest frequency sub-band). 001 = Select sub-band 1. 010 = Select sub-band 2. 011 = Select sub-band 3. 100 = Select sub-band 4. 101 = Select sub-band 5. 110 = Select sub-band 6. 111 = Select sub-band 7 (highest frequency sub-band).
VAS	2	Enables or disables the VCO autotuner function: 1 = VCO and VCO sub-band are programmed automatically by the autotuner. 0 = VCO and VCO sub-band selection is controlled manually by programming the VCO[1:0] and SB[2:0] bits.
ADL	1	Enables or disables the VCO tuning voltage ADC latch when the VCO autotuner is disabled (VAS = 0): 1 = Latches the ADC output. 0 = Disables the ADC latch.
ADE	0	Enables or disables the VCO tuning voltage ADC read when the VCO autotuner is disabled (VAS = 0): 1 = Enables ADC read. 0 = Disables ADC read.

Table 12. Baseband Control Register (Address: 0x0A)

BIT NAME	BIT LOCATION (0 = LSB)	FUNCTION
BB_BW[3:0]	7–4	Programs the bandwidth of the baseband filter. Optimum values for 6MHz to 8MHz wide channels can be calculated after reading a ROM table entry. See the <i>Reading the ROM Table</i> section.
BB_BIA	3	Baseband filter bias current control: 1 = High-bias current. 0 = Low-bias current.
PD_TH[2:0]	2, 1, 0	Programs the power-detector attack point for closed-loop RF gain control; see the <i>Typical Operating Characteristics</i> for power-detector behavior: 000 = Most aggressive RF gain reduction. 001 ... 110

Single-Conversion DVB-H Tuner

Table 13. DC Offset Control Register (Address: 0x0B)

BIT NAME	BIT LOCATION (0 = LSB)	FUNCTION
X	7	Reserved. Set to 0 for normal operation.
DC_DAC8	6	Most significant bit of the DC offset correction DAC.
DC_MO[1:0]	5, 4	Controls the DC offset correction mode of operation: 00 = Offset correction disabled. 01, 10 = I/Q channel DC correction DACs are programmed direct from the DC_DAC[8:0] bits for manual offset correction. 11 = Normal operation.
DC_SP[1:0]	3, 2	Controls the DC offset correction speed (highpass corner frequency): 00 = Offset correction off, hold DAC values. 01 = Select correction speed 1 (slowest correction speed, ~20Hz highpass corner). 10 = Select correction speed 2. 11 = Select correction speed 3 (fastest correction speed, ~500Hz highpass corner).
DC_TH[1:0]	1, 0	Control the DC offset correction accuracy thresholds: 00 = Not recommended. 01 = Keep typical DC offset to within $\pm 100\text{mV}$. 10 = Keep typical DC offset to within $\pm 200\text{mV}$. 11 = Keep typical DC offset to within $\pm 400\text{mV}$.

Table 14. DC Offset DAC Register (Address: 0x0C)

BIT NAME	BIT LOCATION (0 = LSB)	FUNCTION
DC_DAC[7:0]	7-0	Programs the I/Q DC offset DAC for manual DC offset correction. Note the MSB, DC_DAC8, is located in the DC Offset Control register.

Table 15. ROM Table Address Register (Address: 0x0D)

BIT NAME	BIT LOCATION (0 = LSB)	FUNCTION
X	7-4	Reserved. Set to 0000 for normal operation.
TFA[3:0]	3-0	Programs which ROM table address that data is to be read from (see Table 21): 0001 = Tracking filter notch coefficients for 783MHz and 725MHz. 0010 = Balun coefficients for 470MHz and 780MHz. 0011 = Baseband filter bandwidth settings for 7MHz and 8MHz channels. All other codes = Reserved.

Table 16. Reserved Register (Address: 0x0E)

BIT NAME	BIT LOCATION (0 = LSB)	FUNCTION
X	7-0	Reserved. Set to 0x00 for normal operation.

Single-Conversion DVB-H Tuner

Table 17. ROM Table Data Readback Register (Address: 0x10)

BIT NAME	BIT LOCATION (0 = LSB)	FUNCTION
TFR[7:0]	7–0	ROM table data read register. Data from the register at the address programmed into the TFA[3:0] bits are written to this register for reading by the host processor.

Table 18. Chip-Status Readback Register (Address: 0x11)

BIT NAME	BIT LOCATION (0 = LSB)	FUNCTION
POR	7	Power-on-reset indicator: 1 = Power has been reset since last read. 0 = Power has not been reset since last read.
VASA*	6	Indicates whether VCO autotuner selection was successful: 1 = Indicates successful automatic VCO selection. 0 = Indicates the autoselect function is disabled or automatic VCO selection was unsuccessful.
VASE*	5	Status indicator for the VCO autotuner function: 1 = Indicates the automatic VCO selection process is active. 0 = Indicates the automatic VCO selection process is inactive.
LD	4	PLL lock detect: 1 = PLL is locked. 0 = PLL is unlocked.
DC_LO*	3	Indicates DC offset correction accuracy: 1 = DC offset correction detected negative signal excursions in either the I or Q channel. 0 = No signal excursions detected.
DC_HI*	2	Indicates DC offset correction accuracy: 1 = DC offset correction detected positive signal excursions in either the I or Q channel. 0 = No signal excursions detected.
X	1	Reserved.
PD_OVLD	0	Indicates whether the signal level is above or below the programmed attack-point threshold: 1 = Signal is above the programmed attack-point threshold. 0 = Signal is below the programmed attack-point threshold.

*The functionality of these bits is not production tested or guaranteed.

Table 19. Autotuner Readback Register (Address: 0x12)

BIT NAME	BIT LOCATION (0 = LSB)	FUNCTION
VCO[1:0]*	7, 6	Indicates which VCO was selected by the VCO autotuner.
BS[2:0]*	5, 4, 3	Indicates which VCO sub-band was selected by the VCO autotuner.
ADC[2:0]*	2, 1, 0	Provides a 3-bit digital reading of the VCO tuning voltage.

*The functionality of these bits is not production tested or guaranteed.

Single-Conversion DVB-H Tuner

2-Wire Serial Interface

The MAX2165 uses a 2-wire I²C-compatible serial interface consisting of a serial-data line (SDA) and a serial-clock line (SCL). SDA and SCL facilitate bidirectional communication between the MAX2165 and the master at clock frequencies up to 400kHz. The master initiates a data transfer on the bus and generates the SCL signal to permit data transfer. The MAX2165 behaves as a slave device that transfers and receives data to and from the master. SDA and SCL must be pulled high with external pullup resistors (1k Ω or larger) for proper bus operation.

One bit is transferred during each SCL clock cycle. A minimum of nine clock cycles is required to transfer a byte in or out of the MAX2165 (8 bits and an ACK/NACK). The data on SDA must remain stable during the high period of the SCL clock pulse. Changes in SDA while SCL is high and stable are considered control signals (see the *START and STOP Conditions* section). Both SDA and SCL remain high when the bus is not busy.

START and STOP Conditions

The master initiates a transmission with a START condition (S), which is a high-to-low transition on SDA while SCL is high. The master terminates a transmission with a STOP condition (P), which is a low-to-high transition on SDA while SCL is high.

Table 20. Programmable Device Address

ADDR	READ ADDRESS	WRITE ADDRESS
1	0xC3	0xC2
0	0xC1	0xC0

I²C bus is a registered trademark of Philips Corp.

Acknowledge and Not-Acknowledge Conditions

Data transfers are framed with an acknowledge bit (ACK) or a not-acknowledge bit (NACK). Both the master and the MAX2165 (slave) generate acknowledge bits. To generate an acknowledge, the receiving device must pull SDA low before the rising edge of the acknowledge-related clock pulse (ninth pulse) and keep it low during the high period of the clock pulse.

To generate a not-acknowledge condition, the receiver allows SDA to be pulled high before the rising edge of the acknowledge-related clock pulse, and leaves SDA high during the high period of the clock pulse. Monitoring the acknowledge bits allows for detection of unsuccessful data transfers. An unsuccessful data transfer happens if a receiving device is busy or if a system fault has occurred. In the event of an unsuccessful data transfer, the bus master must reattempt communication at a later time.

Slave Address

The MAX2165 has a 7-bit slave address that must be sent to the device following a START condition to initiate communication. The slave address can be programmed to one of two possible addresses through the ADDR pin (Table 20). The eighth bit (R/W) following the 7-bit address determines whether a read or write operation occurs.

The MAX2165 continuously awaits a START condition followed by its slave address. When the device recognizes its slave address, it acknowledges by pulling the SDA line low for one clock period; it is ready to accept or send data depending on the R/W bit (Figure 1).

Write Cycle

When addressed with a write command, the MAX2165 allows the master to write to a single register or to multiple successive registers.

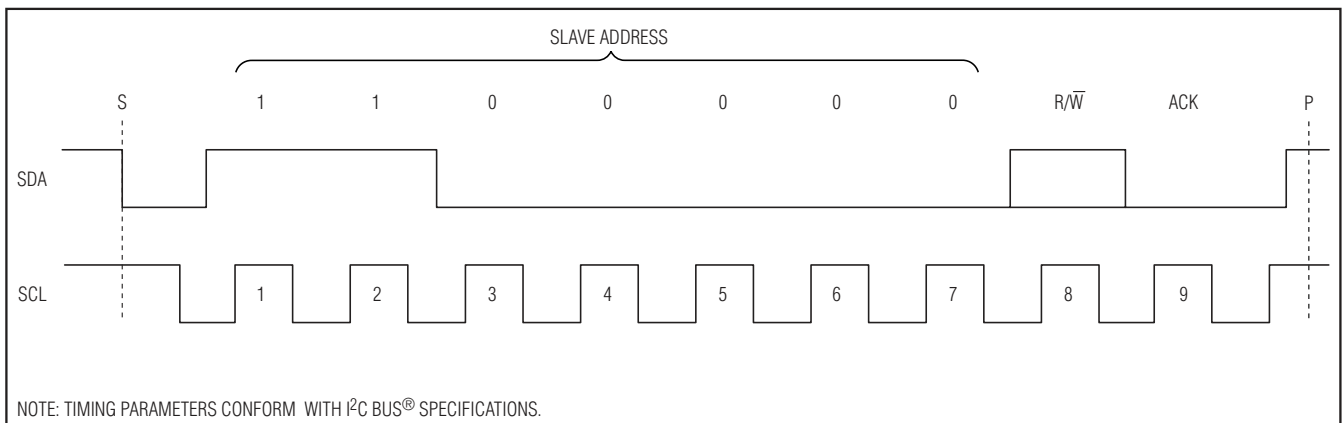

Figure 1. MAX2165 Slave Address Byte

Single-Conversion DVB-H Tuner

START	WRITE DEVICE ADDRESS	R/W	ACK	WRITE REGISTER ADDRESS	ACK	WRITE DATA TO REGISTER 0x00	ACK	WRITE DATA TO REGISTER 0x01	ACK	WRITE DATA TO REGISTER 0x02	ACK	STOP
	110000[ADDR]	0		0x00		0x0E		0xD8		0xE1		

Figure 2. Example of Writing Registers 0 Through 2 with 0x0E, 0xD8, and 0xE1, Respectively

START	WRITE DEVICE ADDRESS	R/W	ACK	WRITE 1st REGISTER ADDRESS	ACK	START	WRITE DEVICE ADDRESS	R/W	ACK	WRITE DATA REG 0	ACK	WRITE DATA REG 1	NACK	STOP
	110000[ADDR]	0		00000000			110000[ADDR]	1		D7-D0		D7-D0		

Figure 3. Example of Reading Data from Registers 0 Through 2

A write cycle begins with the bus master issuing a START condition followed by the 7 slave address bits and a write bit ($R/\bar{W} = 0$). The MAX2165 issues an ACK if the slave address byte is successfully received. The bus master must then send to the slave the address of the first register it wishes to write to (see Table 1 for register addresses). If the slave acknowledges the address, the master can then write one byte to the register at the specified address. Data is written beginning with the most significant bit and is clocked in on the rising edge of SCLK. The MAX2165 again issues an ACK if the data is successfully written to the register. The master can continue to write data to the successive internal registers with the MAX2165 acknowledging each successful transfer, or it can terminate transmission by issuing a STOP condition. The write cycle does not terminate until the master issues a STOP condition.

Figure 2 illustrates an example in which registers 0 through 2 are written with 0x0E, 0xD8, and 0xE1, respectively.

Read Cycle

All registers on the MAX2165 are available to be read by the master with 3 of the registers being read-only.

A read cycle begins with the bus master issuing a START condition followed by the 7 slave address bits and a write bit ($R/\bar{W} = 0$). The MAX2165 issues an ACK if the slave address byte is successfully received. The master then sends the address of the first register that it wishes to read. The MAX2165 then issues another ACK. Next, the master must issue a START condition followed by the 7 slave address bits and a read bit ($R/\bar{W} = 1$). The MAX2165 issues an ACK if it successfully recognizes its address and begins sending data from the specified register address starting with the most significant bit (MSB). Data is clocked out of the MAX2165 on the rising edge of SCLK. On the 9th rising edge of SCLK, the master can issue an ACK and continue reading successive registers, or it can issue a NACK followed by a STOP condition to terminate transmission.

The read cycle does not terminate until the master issues a STOP condition. Figure 3 illustrates an example in which registers 0 and 1 are read back.

Applications Information

RF Input

The RF input is internally matched and provides good return loss over the entire band of operation for either 50Ω or 75Ω systems, and requires a DC-blocking capacitor.

RF and Baseband Gain Control

The MAX2165 features separate RF and baseband gain-control inputs that can be used to achieve optimum SNR over a wide input dynamic range. Baseband gain control is achieved through the BB_AGC pin. This pin is typically controlled by the baseband processor and can accept voltages from 0.4V to 2.3V with 2.3V providing maximum baseband gain.

RF gain control is achieved through the RF_AGC pin. This pin also accepts control voltages from 0.4V to 2.3V with 2.3V providing maximum RF gain. Closed-loop automatic RF gain control can be achieved by connecting the OVLD_DET pin through a lowpass filter to the RF_AGC pin. See the *IF Power Detector* section.

The RF signal path features a low-noise amplifier (LNA) that can be switched in an out-of-signal path. Program the LNASW bit in the LNA register (Table 7) to 1 to enable the LNA. Enabling the LNA adds about 17mA of current, 16dB of gain, and causes less than 10° of phase change in the received signal.

IF Power Detector

The MAX2165 baseband power detector compares the total weighted received input signal within approximately 2 channels of the wanted channel to a programmable threshold. This threshold can be programmed to different values with the PD_TH[2:0] bits in the baseband control register.

Single-Conversion DVB-H Tuner

To close the RF gain-control loop, connect the 300 μ A control current sink of the power detector (pin OVLD_DET) to V_{CC} with a 40k Ω pullup resistor. The resulting voltage is fed with an RC lowpass to the RF_AGC input.

VCO Autotuner

The MAX2165 includes 3 VCOs with each VCO containing 8 VCO sub-bands. The appropriate VCO and VCO sub-band for the desired local oscillator frequency can be manually selected by programming the VCO[1:0] and SB[2:0] bits in the VCO control register (Table 11).

Alternatively, the MAX2165 can be set to autonomously choose a VCO and VCO sub-band. Automatic VCO selection is enabled by setting the VAS bit in the VCO Control register (Table 11). The autotuner begins selecting the appropriate VCO once the fractional portion of the N-divider has been programmed. Therefore, when changing LO frequencies, all the N-divider registers (integer and fractional) must be programmed to activate the autotuner function.

PLL lock detection can be achieved by monitoring the MUX pin or by reading the LD bit in the Chip-Status Readback register (Table 18).

Charge-Pump Current Selection

The PLL charge-pump current can also be either manually programmed or automatically selected by the VCO autotuner. Program the CPS bit in the PLL configuration register (Table 8) to 1 to enable automatic charge-

pump-current selection, or program CPS to 0 to enable manual charge-pump-current selection. The autotuner function must be enabled (VAS = 1) to enable automatic charge-pump-current selection. When in manual mode, the charge-pump current is programmed by the ICP bit in the PLL Configuration register.

VCO Autotuner Delay Selection

During the autotuner selection process, the autotuner must allow time for the PLL to settle before determining if VCO selection was successful. This wait time is programmable through the ADLY[1:0] bits in the PLL Configuration register (Table 8). Program the wait time to be longer than the expected PLL settling time.

RF Notch Filter

The MAX2165 integrates an RF notch filter that can be used to notch out large interfering signals in the 830MHz to 950MHz frequency range to prevent performance degradation when operating in the presence of large cellular phone signals. The notch frequency of the filter is programmable through the TF_NTCH[3:0] bits in the Tracking Filter register (Table 6). Optimal notch filter codes for two different notch frequencies are stored in an on-chip ROM table. See the *Baseband Filter and Tracking Filter* section for additional details. When no interfering cellular signals are present or when receiving signals in the 783MHz to 860MHz frequency range, the TF_NTCH[3:0] bits must be programmed to 111 to move the notch out to the highest possible frequency to minimize the filter's in-band attenuation.

Table 21. ROM Table

DESCRIPTION	ADDRESS	MSB								LSB
		DATA BYTE								
		D7	D6	D5	D4	D3	D2	D1	D0	
Reserved	0x0	X	X	X	X	X	X	X	X	X
Optimal tracking filter notch settings for operation below 725MHz and above 725MHz	0x1	TF_NTCH[3:0] Tracking filter notch low Recommended notch frequency settings for Rx frequencies below 725MHz				TF_NTCH[3:0] Tracking filter notch high Recommended notch frequency settings for Rx frequencies above 725MHz				
Optimal tracking settings at 780MHz and 470MHz	0x2	TF_BAL[3:0] Optimal tracking filter settings at 780MHz				TF_BAL[3:0] Optimal tracking filter settings at 470MHz				
Optimal baseband filter BW for 8MHz channel	0x3	BB_BW[3:0] 8MHz wide				X	X	X	X	

Single-Conversion DVB-H Tuner

Unlike the tracking filter, it is not necessary to interpolate notch filter settings for various operating frequencies. When receiving channels below 725MHz in the presence of cellular blockers, the TF_NTCH[3:0] bits should be programmed to the lower notch frequency that is stored in the ROM table. When receiving channels above 725MHz in the presence of cellular blockers the TF_NTCH[3:0] bits can be programmed to the upper notch frequency that is stored in the ROM table.

Baseband Filter and Tracking Filter

The MAX2165 includes programmable baseband and tracking filters. The baseband filter bandwidth is controlled through the BB_BW[3:0] bits in the Baseband Control register (Table 12). The tracking filter's balun frequency can be programmed through the TF_BAL[3:0] in the Tracking Filter register (Table 6).

Reading the ROM Table

To accommodate process variations, each part is factory calibrated. During calibration, the best notch filter settings for two different notch frequencies, the best balun settings for 470MHz and 780MHz, and the best baseband filter settings for 6MHz to 8MHz channels are determined. These settings are stored in an on-chip ROM table that must be read upon power-up and stored in the microprocessor local memory (3 bytes total). Table 21 shows the address and bits for each ROM table entry.

Each ROM table entry must be read using a two-step process. First, the address of the bits to be read must be programmed into the TFA[3:0] bits in the ROM Table Address register (Table 15).

Once the address has been programmed, the data stored in that address is transferred to the TRF[7:0] bits in the ROM Table Data Readback register (Table 17). The ROM data at the specified address can then be read from the TRF[7:0] bits and stored in the microprocessor's local memory.

Interpolating Balun Coefficients

The TF_BAL[3:0] bits must be reprogrammed for each channel frequency to optimize performance over the band. The values given for 780MHz and 470MHz in the ROM table can be used to interpolate the optimal coefficients for any other frequency using the equation:

$$\text{Value} = \text{BAL_L} + (\text{BAL_H} - \text{BAL_L}) \times \frac{f - 470\text{MHz}}{780\text{MHz} - 470\text{MHz}}$$

where:

Value = decimal value of the optimal TF_BAL[3:0] setting for desired channel frequency, f

BAL_L = decimal value of the optimal TF_BAL[3:0] setting for 470MHz as read from the ROM table

BAL_H = decimal value of the optimal TF_BAL[3:0] setting for 780MHz as read from the ROM table

f = desired channel frequency in MHz

Example: Assume the TF_BAL[3:0] values read from the ROM table for 780MHz and 470MHz are 14 and 2, respectively, and we wish to program the balun for operation at an RF frequency of 620MHz.

Using the previous equation, we can calculate:

$$\text{Value at 620MHz} = 2 + (14 - 2) \times \frac{620\text{MHz} - 470\text{MHz}}{780\text{MHz} - 470\text{MHz}} = 7.8$$

Rounding to the nearest integer value gives us 8; therefore, when operating at 620MHz, the TF_BAL[3:0] bits in the Tracking Filter register must be programmed to 1000.

Setting the Baseband Filter

The MAX2165 baseband filter is freely programmable over a wide range of 3dB cutoff frequencies from approximately 3.0MHz to 4.3MHz, but the exact cutoff frequency varies from part-to-part due to manufacturing process variations. To avoid requiring the user to find the correct setting, the best setting for a 3.9MHz cutoff frequency (i.e., 8MHz wide DVB-T/H channels) is determined by Maxim and stored on a ROM table on every chip. The user needs to read this value from the ROM table entry 0x3 (see Table 21) and write it back into register 0xA bits BB_BW[3:0] (see Table 12) upon powering up the MAX2165.

Baseband Filter Setting for RF Channels Other than 8MHz or Modulation Types Other than DVB-T

If a different cutoff frequency than 3.9MHz is desired, a fixed value per Table 22 can be added or subtracted from the number read-out of the ROM table, before writing it back into the corresponding MAX2165 register. This way the factory calibration is still utilized and the resulting cutoff frequency is still reasonably accurate.

Single-Conversion DVB-H Tuner

Table 22. Offsets for Various Cutoff Frequencies

DESIRED 3dB CUTOFF FREQUENCY (TYPICAL) (MHz)	OFFSET TO BE ADDED TO ROM TABLE ENTRY 0x3 BEFORE WRITING BACK INTO REGISTER 0xA
3.10	-6
3.20	-5
3.30	-4
3.44	-3
3.56	-2
3.70	-1
3.90	0
4.10	+1
4.23	+2

DC Offset Correction

Direct-conversion receivers are susceptible to DC offsets that can limit linearity performance, as well as downstream data converter/demodulator dynamic range. The MAX2165 includes on-chip fast-settling DC offset cancellation circuitry that requires no off-chip components to remove any undesirable DC offsets that are present in the output signal.

The correction threshold can be programmed to four different values through the DC_TH[1:0] bits in the DC Offset Control register (Table 13).

When offset correction is active, the correction circuitry creates a highpass characteristic in the signal path with the highpass cutoff frequency determining the offset correction speed. This correction speed is programmable through the DC_SP[1:0] bits in the DC Offset Control register.

For DVB-H applications, it is recommended that the DC correction be performed once after the part is taken out of shutdown, then disabled by programming the DC_SP[1:0] bits to 00 (hold state). Disabling the DC offset correction during signal reception prevents the highpass characteristic introduced by the correction circuitry from distorting the lower frequency components of the received signal and allows for DC-coupling to the demodulator. The only requirements for operation with DC-coupling are that the receive frequency and baseband filter setting remain constant after the one-time cancellation. The typical time-sliced operating nature of DVB-H easily allows for operation under these conditions.

The part can be configured to automatically perform DC correction upon power-up through the use of the SHDN and STBY pins. See the *Power-Up Sequence* section for further information.

Power-Up Sequence and Shutdown Modes

Driving the SHDN pin low places the MAX2165 in hardware shutdown mode, where all internal circuits are disabled and the supply current decreases to less than 20µA. Driving SHDN low shuts the entire IC down regardless of the state of the internal registers except for the shutdown reference bit (SHDN_REF). Register settings are maintained when the part comes out of shutdown mode.

The MAX2165 also features a software-shutdown mode. In software-shutdown mode, the individual bits of the Shutdown register can be programmed to power down the MAX2165 functional blocks. Program the Shutdown register (Table 10) to 0xFF, the VCO[1:0] bits in the VCO Control register (Table 11) to 00, and the DC_MO[1:0] bits in the DC Offset Control register (Table 13) to 00 to shut down the entire chip through the software.

The MAX2165 features a power-up sequencer that very quickly removes the DC offset upon exiting hardware shutdown mode. To enable the power-up sequence feature, connect STBY to ground while SHDN transitions from low to high.

Power-Up Sequence

Holding STBY low while SHDN transitions high causes the part to power up in a two-step process. In the first step, the VCO and PLL power up and settle. The typical current consumption during this first step is approximately 20mA. In the second step, the entire signal path is powered up and the RF_AGC voltage, the BB_AGC voltage, and the DC correction are automatically overridden with DC offset correction performed in less than 0.5ms. Once DC correction has been achieved the part is returned to its originally programmed state. The entire power-up process completes in approximately 2ms.

Single-Conversion DVB-H Tuner

The benefit of the automatic DC correction is that it allows the DC offset to be removed in less than 0.5ms, much faster than the effective highpass corner frequency of the correction circuit would otherwise allow. If the DC_SP[1:0] bits are programmed to 00 prior to exiting hardware shutdown, the part performs a one-time DC offset cancellation upon power up then disables the DC correction circuitry after the power-up sequence completes. This allows for DC-coupling between the baseband outputs and the demodulator as long as the receive frequency, baseband filter setting, and chip temperature stay constant after the one-time cancellation. A change in these parameters while the chip is receiving requires recalibration of the DC offset. However, the typical time-sliced nature of DVB-H does meet the above requirements for operation with DC-coupling.

When $\overline{\text{STBY}}$ is connected to VCC, the chip does not follow the power-up procedure described above, and all circuit blocks are powered up at the same time. If the DC_SP[1:0] bits are set to 00 (i.e., quasi-DC-coupled), a DC calibration is never executed and the MAX2165 is not functional.

The state of the $\overline{\text{STBY}}$ pin only determines whether or not DC correction is automatically performed upon exiting hardware shutdown.

Crystal-Oscillator Interface

The MAX2165 reference-oscillator input can be configured as a crystal oscillator or it can be used as a high-impedance reference input driven by an external source.

When using an external reference oscillator, drive XB through an AC-coupling capacitor with a signal amplitude

of approximately 1V_{p-p} and leave XE unconnected. The phase noise of the external reference must exceed -140dBc/Hz at offsets of 1kHz to 100kHz.

When connecting directly to a crystal, see the *Typical Application Circuit* for the required topology.

Crystal-Oscillator Buffer Output

A buffered crystal-oscillator signal is provided at the REFOUT pin and can be used to drive the demodulator. This output requires a DC-blocking capacitor. This buffer can be enabled or disabled through the SHDN_REF bit in the Shutdown register (Table 10).

Layout Considerations

The EV kit can serve as a guide for PCB layout. Keep RF signal lines as short as possible to minimize losses and radiation. Use controlled impedance on all high-frequency traces. The exposed paddle must be soldered evenly to the board's ground plane for proper operation. Use abundant vias beneath the exposed paddle for maximum heat dissipation. Use abundant ground vias between RF traces to minimize undesired coupling. To minimize coupling between different sections of the IC, the ideal power-supply layout is a star configuration, which has a large decoupling capacitor at the central VCC node. The VCC traces branch out from this node with each trace going to separate VCC pins of the MAX2165. Each VCC pin must have a bypass capacitor with a low impedance to ground at the frequency of interest. Do not share ground vias among multiple connections to the PCB ground plane.

Single-Conversion DVB-H Tuner

Typical Application Circuit

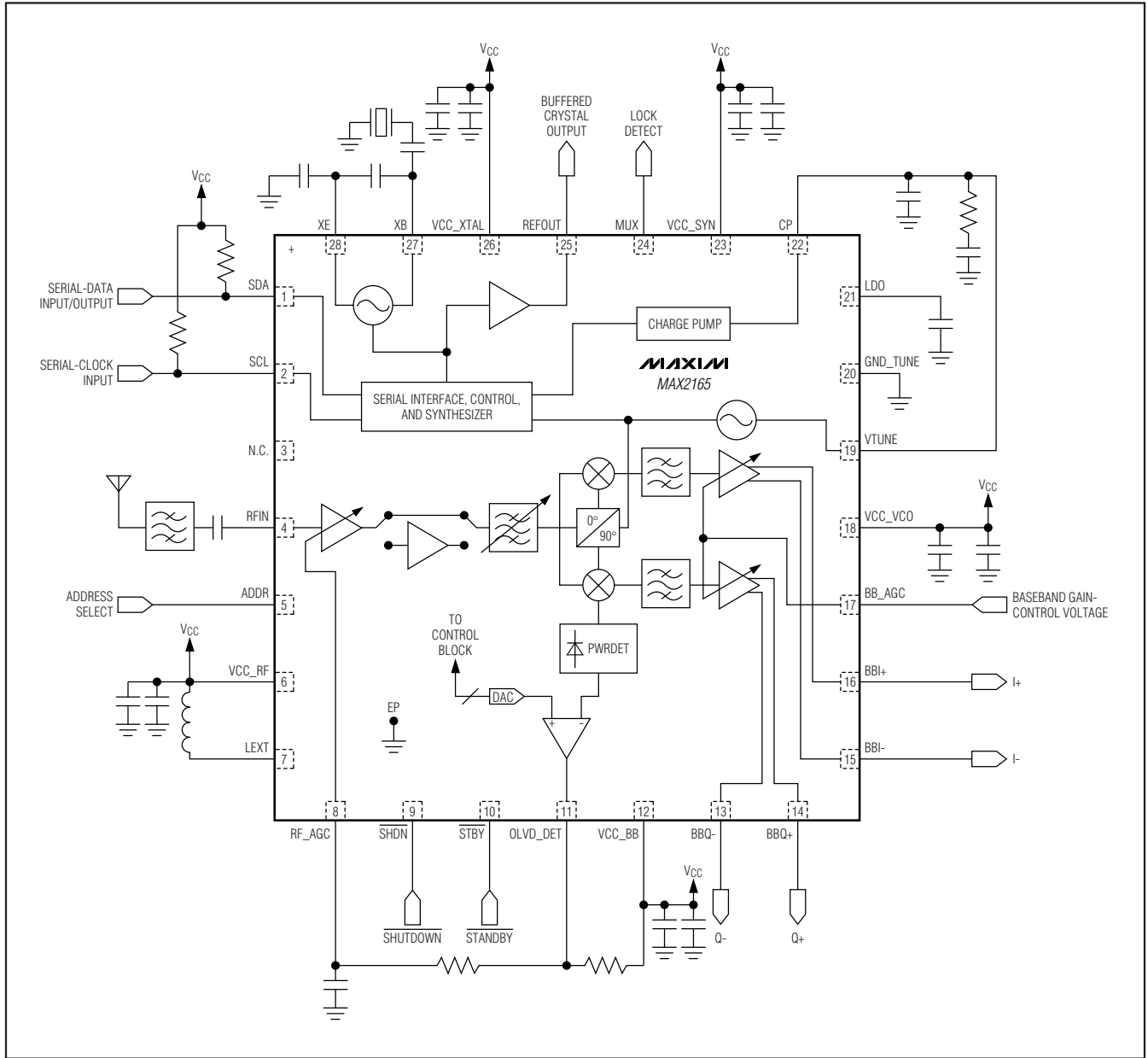

Single-Conversion DVB-H Tuner

Package Information

MAX2165

For the latest package outline information and land patterns, go to www.maxim-ic.com/packages.

PACKAGE TYPE	PACKAGE CODE	DOCUMENT NO.
28 TQFN-EP	T2855-8	21-0140

Single-Conversion DVB-H Tuner

Revision History

REVISION NUMBER	REVISION DATE	DESCRIPTION	PAGES CHANGED
0	6/07	Initial release	—
1	3/09	Added Note 3 to Spurious Emissions at RF Input specification, added condition to Passband Cutoff Attenuation and Amplitude Ripple specifications, corrected Notes 1, 6, and 11	3, 4, 5

Maxim cannot assume responsibility for use of any circuitry other than circuitry entirely embodied in a Maxim product. No circuit patent licenses are implied. Maxim reserves the right to change the circuitry and specifications without notice at any time.

24 **Maxim Integrated Products, 120 San Gabriel Drive, Sunnyvale, CA 94086 408-737-7600**