

RER-230-6B

Electronics & Interface > Slim Relay

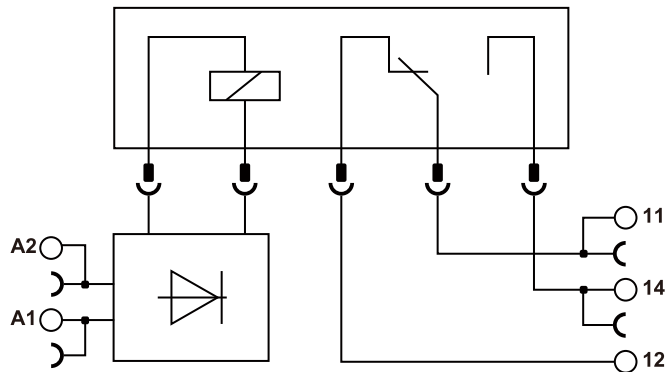

The web catalog is for reference only. Dinkle remains the right of product modification and engineering change of the design. The final product is made according to engineering drawing.

Specification

Coil	
Norminal input voltage	230VAC / VDC
Norminal input current	3.7mA
Typical response time	≤8ms
Typical release time	≤4ms
Protective circuit	Bridge rectifier
Indicator	Green LED
Contact	
Contact type	1C
Contact material	AgNi
Contact rating (Res. load)	6V , 250VAC / 30VDC
Max. switching voltage	400VAC / 125VDC
Max. switching current	6A
Contact resistance	≤100mΩ (1A, 6VDC)
Mechanical endurance	1 x 10 ⁷ cycles
Electrical endurance	3 x 10 ⁴ cycles, NO 1 x 10 ⁴ cycles, NC
General	

Dielectric strength	Coil & contacts	4000VAC / 1min
	Open contacts	1000VAC / 1min
Ambient temperature		-40°C ~ 85°C
Ambient humidity		5% ~ 85% RH
Shock resistance	Functional	49m/s ²
	Destructive	980m/s ²
Vibration resistance		10Hz ~ 55Hz 1mm (dual amplitude)
T x W x H	(mm)	6.2 x 103 x 78.8
Weight		30g
Solid/Stranded wire (AWG/mm ²)		20-16 / 0.5-1.5
Connection method		Spring clamp
Screw torque		-

Accessories Part No.

Plug-in bridge	0149-4S-20
DIN Rail	TS-35 TS-35/15
Tool	0.4x2.5 mm
End bracket	SS4N
Relay	RER-H1C-D60

Approvals

