

**Phase Control SCR**  
**1200 Amperes Average**  
**4400 Volts**

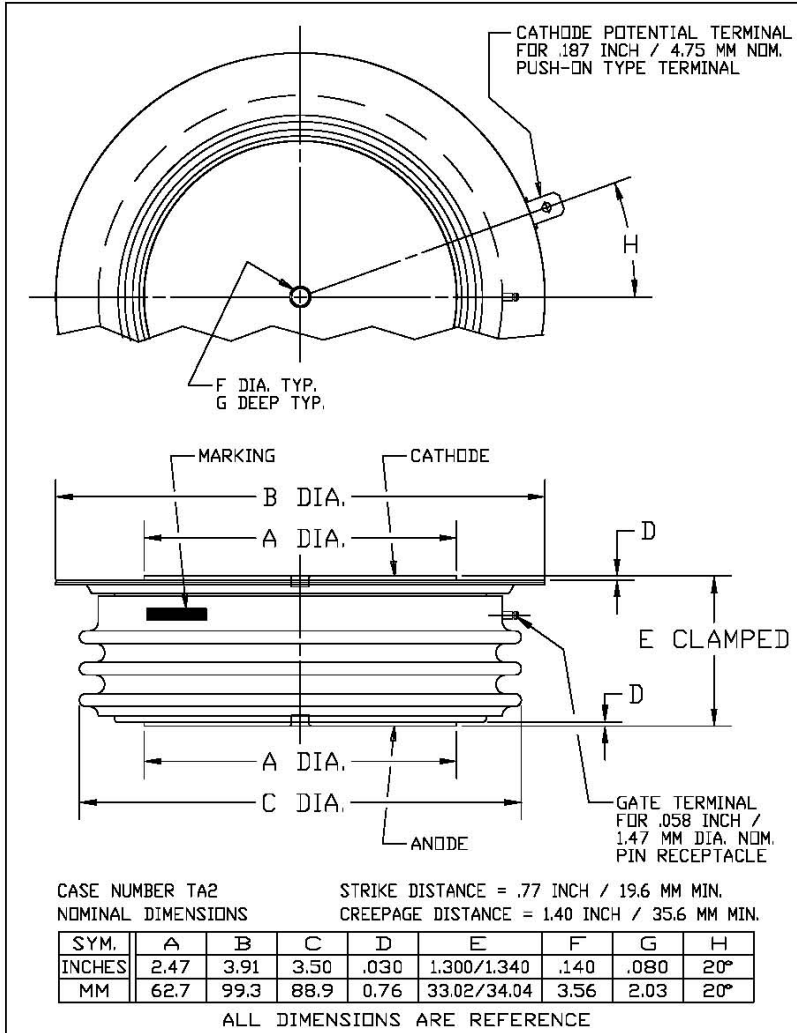

TAK7 120A (Outline Drawing)

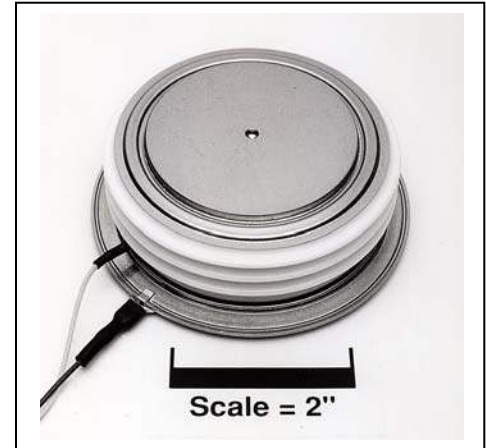

**TAK7 1200A Phase Control SCR**  
1200 Amperes Average, 4400 Volts

**Description:**

Powerex Silicon Controlled Rectifiers (SCR) are designed for phase control applications. These are all-diffused, Press-Pak, hermetic Pow-R-Disc devices employing the field proven amplifying gate.

**Features:**

- Low On-State Voltage
- High di/dt Capability
- High dv/dt Capability
- Hermetic Packaging
- Excellent Surge and I<sup>2</sup>t Ratings

**Applications:**

- Power Supplies
- Battery Chargers
- Static VAR

**Ordering Information:**

Select the complete 12 digit module part number from the table below.  
Example: TAK7441202DH is a 4400V 1200A Phase Control SCR.

Type	Voltage V <sub>RRM</sub> (Volts)	Current I <sub>T(av)</sub> (A)	Turn-off Time t <sub>q</sub> (µsec)	Gate Current I <sub>GT</sub> (mA)	Lead Code
TAK7	36 40 44	12	0	2	DH
	3600V 4000V 4400V	1200A	500 µsec (Typical)	300 mA	12"

**Absolute Maximum Ratings**

Characteristics	Symbol		Units
Non-Repetitive Transient Peak Reverse Blocking Voltage	$V_{RSM}$	$V_{RRM} + 100V$	Volts
RMS On-State Current, $T_C = 82^\circ C$	$I_{T(RMS)}$	1700	Amperes
Average Current 180° Sine Wave, $T_C = 82^\circ C$	$I_{T(AV)}$	1200	Amperes
RMS On-State Current, $T_C = 55^\circ C$	$I_{T(RMS)}$		Amperes
Average Current 180° Sine Wave, $T_C = 55^\circ C$	$I_{T(AV)}$	960	Amperes
Peak One Cycle Surge On-State Current (Non-Repetitive) 60 Hz	$I_{TSM}$	40,000	Amperes
Peak One Cycle Surge On-State Current (Non-Repetitive) 50 Hz	$I_{TSM}$	36,500	Amperes
Critical Rate-of-rise of On-State Current (Non-Repetitive)	di/dt	400	A/ $\mu$ sec
Critical Rate-of-rise of On-State Current (Repetitive)	di/dt	150	A/ $\mu$ sec
$I^2t$ (for Fusing) for One Cycle, 60 Hz	$I^2t$	$6.67 \times 10^9$	A <sup>2</sup> sec
Peak Gate Power Dissipation	$P_{GM}$	16	Watts
Average Gate Power Dissipation	$P_{G(av)}$	3	Watts
Operating Temperature	$T_J$	-40 to +125	°C
Storage Temperature	$T_{stg}$	-40 to +150	°C
Approximate Weight		2.2	lb
		1000	g
Mounting Force		9000 to 11000	lb.
		4100 to 5000	kg.

Information presented is based upon manufacturers testing and projected capabilities.  
This information is subject to change without notice.  
The manufacturer makes no claim as to the suitability of use, reliability, capability,  
or future availability of this product.

**Electrical Characteristics,  $T_J=25^\circ\text{C}$  unless otherwise specified**

Characteristics	Symbol	Test Conditions	Min.	Typ.	Max.	Units
Repetitive Peak Reverse Leakage Current	$I_{RRM}$	$T_J=125^\circ\text{C}, V_R = V_{RRM}$			250	mA
Repetitive Peak Forward Leakage Current	$I_{DRM}$	$T_J=125^\circ\text{C}, V_D = V_{DRM}$			250	mA
Peak On-State Voltage	$V_{TM}$	$T_J=25^\circ\text{C}, I_{TM}=1500\text{A peak},$ Duty Cycle < 0.1 %			1.90	V
Threshold Voltage, Low-level	$V_{(TO)1}$	$T_J = 125^\circ\text{C}, I_{TM} = 250\text{A to } 4000\text{A}$			1.262	V
Slope Resistance, Low-level	$r_{T1}$				0.397	$m\Omega$
Threshold Voltage, High-level	$V_{(TO)2}$	$T_J = 125^\circ\text{C}, I_{TM} \geq 4000\text{A}$			1.412	V
Slope Resistance, High-level	$r_{T2}$				0.368	$m\Omega$
$V_{TM}$ Coefficients		$T_J = 125^\circ\text{C}$		A =	2.53	
				B =	-0.294	
		$V_{TM} = A + B \ln(I) + C(I) + D \text{ Sqrt}(I)$		C =	2.47 E-04	
				D =	0.0284	
Typical Delay Time	$t_d$	$I_{TM} = 1000\text{A}, V_D = 1500\text{ V}$		4		$\mu\text{s}$
Typical Turn-Off Time	$t_q$	$T_J = 125^\circ\text{C}, I_T = 250\text{A},$ $di_R/dt = 50\text{A}/\mu\text{s}$ Reapplied $dv/dt = 20\text{ V}/\mu\text{s}$ Linear to 80% $V_{DRM}$		500		$\mu\text{s}$
Minimum Critical $dv/dt$ – Exponential to $V_{DRM}$	$dv/dt$	$T_J = 125^\circ\text{C}$	1000			$\text{V}/\mu\text{s}$
Gate Trigger Current	$I_{GT}$	$T_J = 25^\circ\text{C}, V_D = 12\text{ V}$			300	mA
Gate Trigger Voltage	$V_{GT}$	$T_J = 25^\circ\text{C}, V_D = 12\text{ V}$			5.0	V
Non-Triggering Gate Voltage	$V_{GDM}$	$T_J = 125^\circ\text{C}, V_D = V_{DRM}$			0.45	V
Peak Forward Gate Current	$I_{GTM}$				4	A
Peak Reverse Gate Voltage	$V_{GRM}$				5	V

**Thermal Characteristics**

Maximum Thermal Resistance, Double Sided Cooling		Max.	Units
Junction-to-Case	$R_{\theta(J-C)}$	0.015	$^\circ\text{C}/\text{W}$
Case-to-Sink	$R_{\theta(C-S)}$	0.007	$^\circ\text{C}/\text{W}$

Powerex, Inc., 173 Pavilion Lane, Youngwood, Pennsylvania 15697 (724) 925-7272  
www.pwr.com

**Phase Control SCR**  
**1200 Amperes Average**  
**4400 Volts**

**Maximum On-State Forward Voltage Drop**  
( $T_J = 125^\circ\text{C}$ )

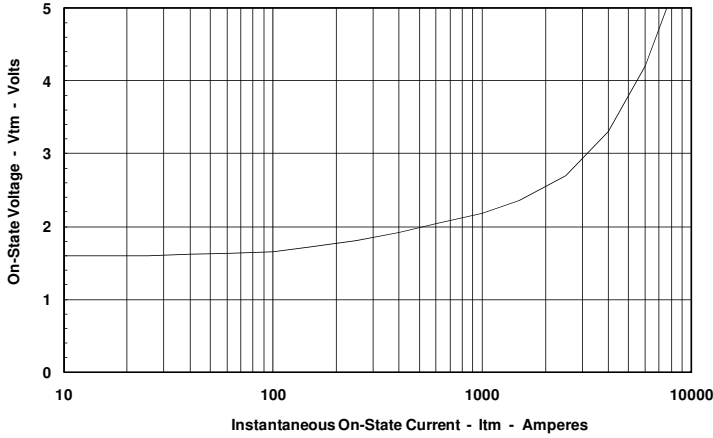

**Maximum Transient Thermal Impedance**  
(Junction to Case)

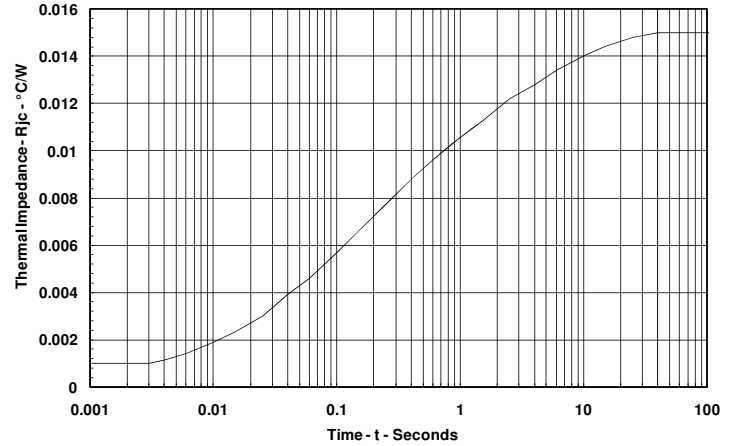

**Maximum On-State Power Dissipation**  
(Sinusoidal Waveform)

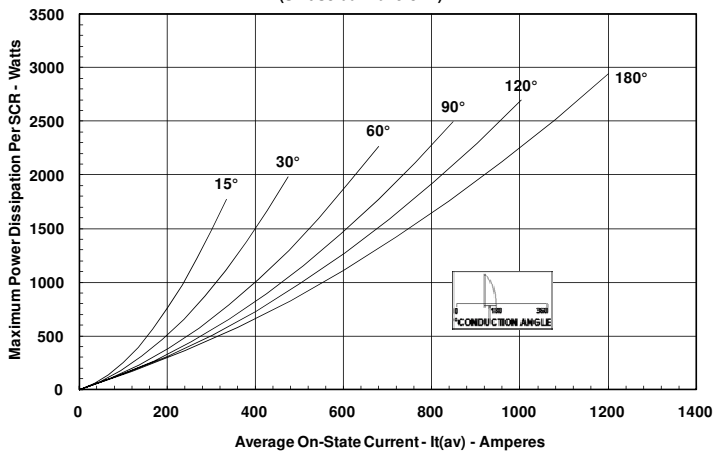

**Maximum Allowable Case Temperature**  
(Sinusoidal Waveform)

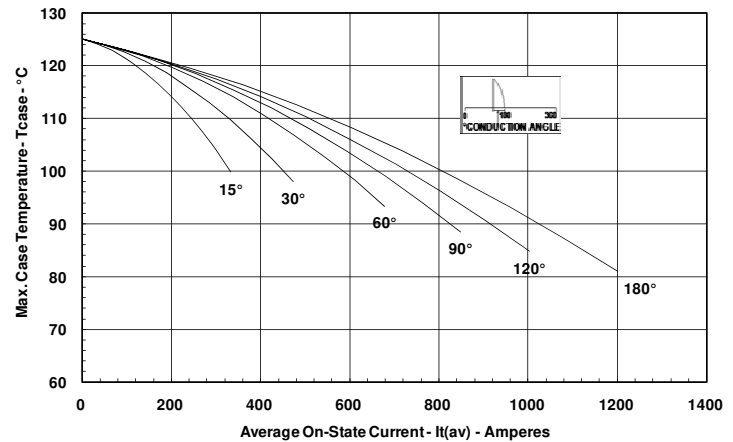

**Maximum On-State Power Dissipation**  
(Rectangular Waveform)

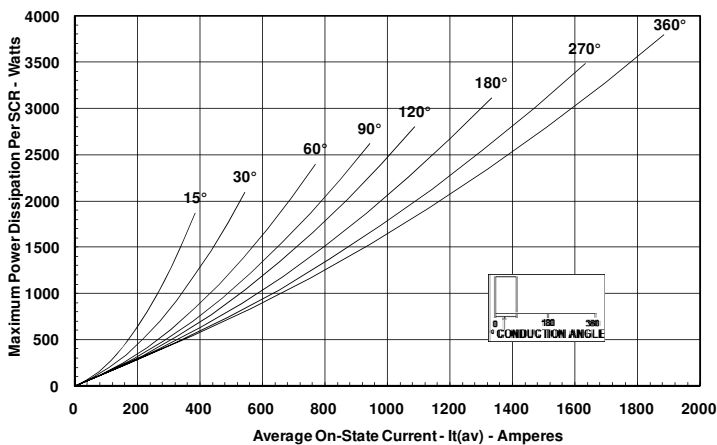

**Maximum Allowable Case Temperature**  
(Rectangular Waveform)

