

Catalog #:	
Project :	
Type :	Date:
Notes:	

LED Center Basket Troffer Luminaire

TECBTA SERIES

DESCRIPTION

High performance lumens per watt offer deepest energy savings. Durable white aluminum body & frosted PC lens. 100% Mercury & Lead Free.

APPLICATIONS

Ideal for lighting offices, schools, hospitality, healthcare & other industrial applications. Easy to install, Snap-on lens, and improved aesthetics.



QUICK SHIP:

TECBTA2430W40KD1WP	TECBTA2230W40KD1WP
TECBTA2440W50KD1WP	TECBTA2240W40KD1WP
TECBTA2440W40KD1WP	
TECBTA2440W50KD1WP	

Made in India

Specification Features



Controls / Dimming

High quality isolated driver; 0-10V dimming; Flicker free. Optional sensor and Emergency Battery Backup available.

Certification

It complies with ETL certification, DLC Applied for. IP20 Rated.

Warranty

5 Years Limited Warranty. See warranty documentation for more information.

Installation / Mounting

Luminaire installs in Lay-in T-Bar Grid or Drop-In Ceiling Mount, Cable Install or Surface Mount install. Beam angle is 150°. Instant start w/NO humming.

Ordering Information

Example: TECBTA2430W40KD1WP

TE	CBTA	24	30W	40K	D1	Voltage	W	J
Brand	Series	Size	Nominal Wattage	Color Temp	Dimmable	Voltage	Housing Color	Version
TE TechnoLED	CBTA Center Basket Troffer	22 2x2 24 2x4	20W 20 Watt 30W 30 Watt 40W 40 Watt 50W 50 Watt	35K 3500K 40K 4000K 50K 5000K	D1 Dimmable N1 Non-Dimmable	Blank 100-277V	W White B Black G Gray	J Standard P Premium
Available Options								
Controls/Mounting/Options								
EM	Emergency 90 Min. Battery Backup							
SMK	Surface Mounting Kit							
CMK	Cable Mount Kit							
N	No Sensor							
P	Microwave Sensors							



Lighting Parameters

Input Voltage	AC100-277V
CCT	3500K / 4000K / 5000K
CRI	Ra>80
Luminous efficacy	125lm/w
PF	0.90
Driver Efficiency	87%
THD	15%
Working temperature	-4°F~104°F
Storage temperature	-22°F~130°F
IP Rating	IP20 Rated

Product Dimension

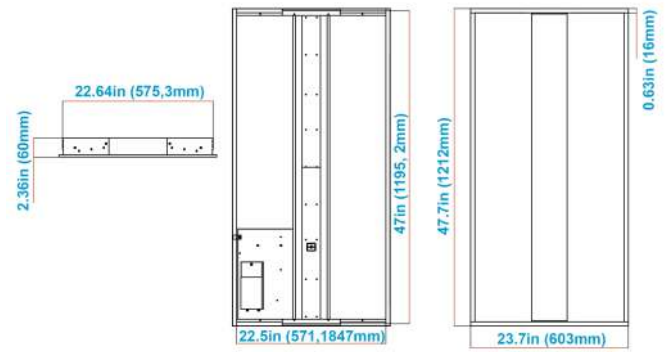

TECBTA22YYWXXKD1WP (2ft x 2ft)	23.74" (L)	23.74" (W)	2.36" (H)
TECBTA24YYWXXKD1WP (2ft x 4ft)	47.74" (L)	23.74" (W)	2.36" (H)

Installation Instructions

Please read the instructions carefully before installation

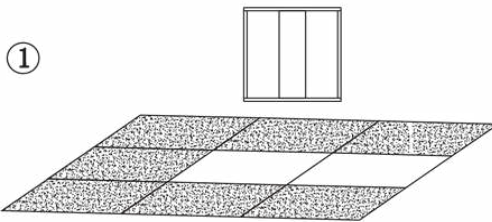

Step 1. Remove two boards.

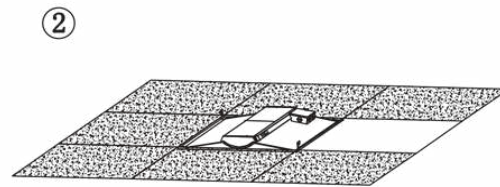

Step 2. Put the lamp on ceiling.

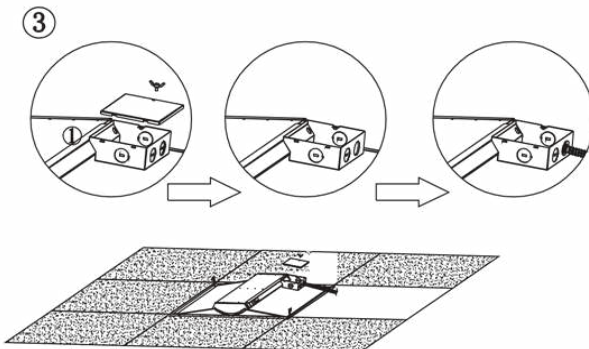

Step 3. Open the cover of junction box; Knock off the piece of side and let the wire conduit through junction box.

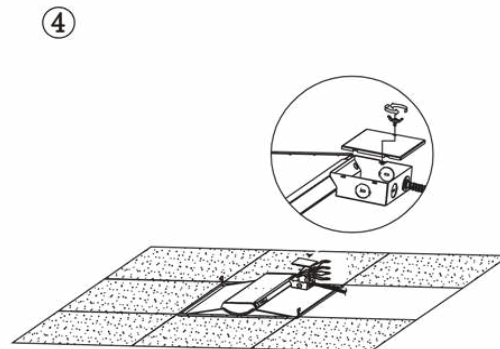

Step 4. Connect the wires with P2, Refer to wiring diagram as below.

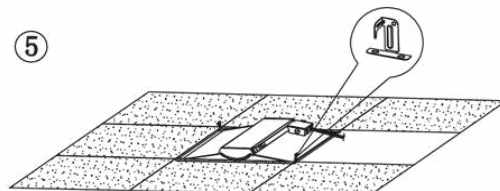

Step 5. Lock the lamp on framework.

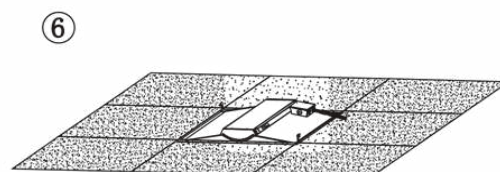

Step 6. Put another board back, check the lamp must be placed firmly.

