

K10KAC-P07LCC0-4500
series_k, type_k1

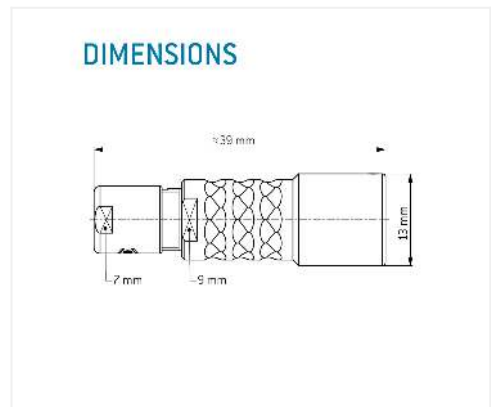

General information

| | |
|--------------------------|---------------------|
| Part number | K10KAC-P07LCC0-4500 |
| Termination | solder |
| Size | 0 |
| Locking principle | break , push |
| Coding | a_key |
| Cable Diameter | cable_mini_45 |
| Cable outlet | standard |

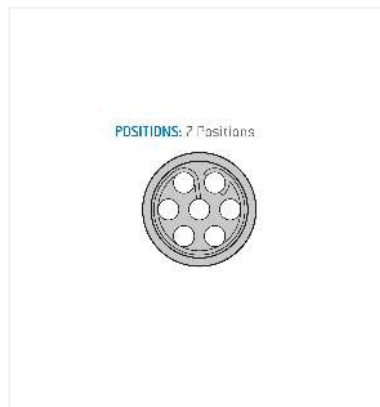
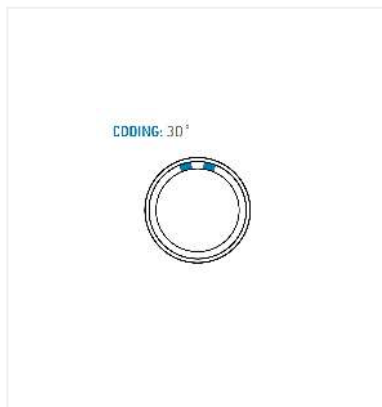

Contact insert description

| | |
|-----------------------------|---------|
| Number of contacts | 7 |
| Contact type | sockets |
| Contact diameter | 05mm |
| Insulator material | peek |
| Wire cross section | 28_awg |
| Termination | solder |
| Termination diameter | 04mm |

reverse_gender_on_request

Technical information

| | | |
|---|----------|---------------|
| Max. creepage and air clearance distance | 07_mm | 07_mm |
| Nominal current single contact | 04_a | iec_60512_5_2 |
| Nominal current insert | 2,6 A | vde_0298_4 |
| Test voltage | 09_kv_ac | sae_13441 |

safety_text

Mechanical and environmental data

| | |
|-----------------------|----------|
| Degree of protection* | ip68 |
| Operating temperature | 40_120_c |
| Mating cycles | 5000 |

mated

Material and surface treatments

| | |
|---------|---------------|
| Housing | m_chrome |
| Contact | cu_alloy_gold |

safety_text_2
ul_text
illustrative_text