

General information

Part number	S11MOC-P02MPHO-6540
Termination	solder
Size	1
Locking principle	push
Coding	0 key
Cable Diameter	cable medi 65
Cable outlet	standard

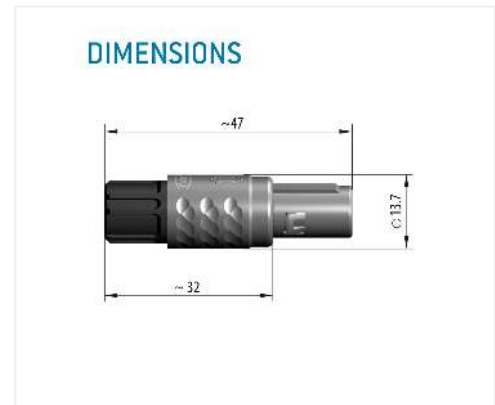
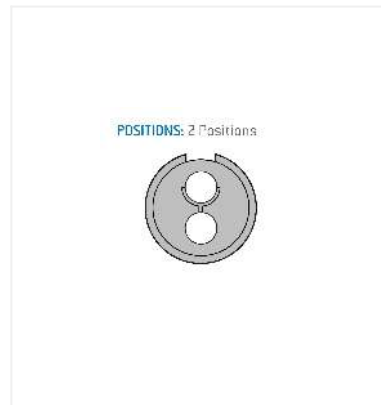
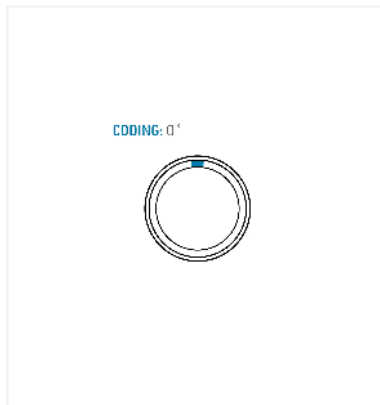

Contact insert description

Number of contacts	2
Contact type	pins
Contact diameter	13mm
Insulator material	peek
Wire cross section	20_awg
Termination	solder
Termination diameter	11mm

reverse_gender_on_request

Technical information

Max. creepage and air clearance distance	13_mm	
Nominal current single contact	12_a	iec_60512_5_2
Nominal current insert	12 A	vde_0298_4
Test voltage	19_kv_dc	sae_13441

safety_text

Mechanical and environmental data

Degree of protection*	ip50
Operating temperature	50_120_c
Mating cycles	2000

mated_unmated

Material and surface treatments

Housing	m_chrome
Color option	yellow
Contact	cu_alloy_gold

safety_text_2
ul_text
illustrative_text