

S13LOC-P10MPHO-1900
series_l, type_s1

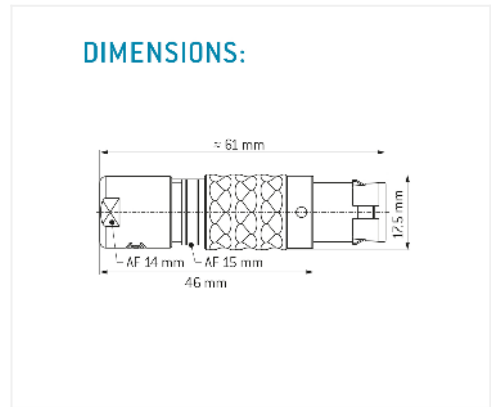

General information

Part number	S13LOC-P10MPHO-1900
Termination	solder
Size	3
Locking principle	push
Coding	0_key
Cable Diameter	cable_mini_19
Cable outlet	standard

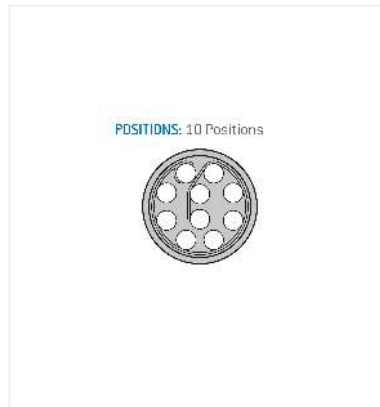

Contact insert description

Number of contacts	10
Contact type	pins
Contact diameter	13mm
Insulator material	peek
Wire cross section	20_awg
Termination	solder
Termination diameter	11mm

reverse_gender_on_request

Technical information

Max. creepage and air clearance distance	12_mm	14_mm
Nominal current single contact	12_a	iec_60512_5_2
Nominal current insert	6,6 A	vde_0298_4
Test voltage	135_kv_ac	sae_13441

safety_text

Mechanical and environmental data

Degree of protection*	ip50
-----------------------	------

Operating temperature	40_120_c
-----------------------	----------

Mating cycles	5000
---------------	------

mated_unmated

Material and surface treatments

Housing	m_chrome
---------	----------

Contact	cu_alloy_gold
---------	---------------

safety_text_2

ul_text

illustrative_text