

STS232033U202

TVS Diode array for ESD protection



Product features

- 350 watts peak pulse power per line (t_p=8/20 μs)
- Protects two I/O lines with uni-directional
- Low clamping voltage
- Working voltage: 3.3 V
- Low leakage current
- Meets moisture sensitivity level (MSL) 3
- Molding compound flammability rating: UL 94V-0
- Termination finish: Tin

Applications

- RS-232, RS-422 & RS-485
- Servers, notebook, and desktop
- Cellular handsets and accessories
- Control & monitoring systems
- Portable electronics
- Wireless bus protection
- Set-top box

Environmental compliance and general specifications

- IEC61000-4-2 (ESD)
 - ±15 kV (air)
 - ±8 kV (contact)
- IEC61000-4-5 (Lightning) 25 A (8/20 μs)



Ordering part number

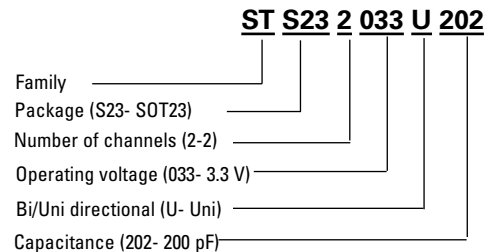

Pin out/functional diagram

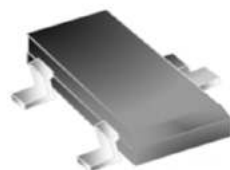

SOT-23

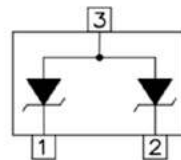

Pin Configuration

Absolute maximum ratings

(+25 °C, RH=45%-75%, unless otherwise noted)

STS232033U202

Parameter	Symbol	Value	Unit
Peak pulse power dissipation on 8/20 μs waveform	P_{PP}	350	W
ESD per IEC 61000-4-2 (Air)	V_{ESD}	+/-15	kV
ESD per IEC 61000-4-2 (Contact)		+/-8	
Lead soldering temperature	T_L	+260 (10 seconds)	°C
Operating junction temperature range	T_J	-55 to +125	°C
Storage temperature range	T_{STG}	-55 to +150	°C

Electrical characteristics

(+25 °C)

STS232033U202

Parameter	Test condition	Minimum	Typical	Maximum	Symbol (Units)
Reverse working voltage	-	-	-	3.3	V_{RWM} (V)
Reverse breakdown voltage	$I_T = 1$ mA	4	-	-	V_{BR} (V)
Reverse leakage current	$V_{RWM} = 3.3$ V	-	-	5	I_R (μA)
Clamping voltage	$I_{PP} = 1$ A, $t_p = 8/20$ μs	-	-	8	V_C (V)
		$I_{PP} = 25$ A, $t_p = 8/20$ μs	-	-	14
Junction capacitance	$V_{RWM} = 0$ V, $f = 1$ MHz	-	200	240	C_J (pF)*

* C_J measured at $V_{RWM} = 0$ V, 1 MHz (pin1 to pin3, pin2 to pin3).

Mechanical parameters, pad layout- mm/inches

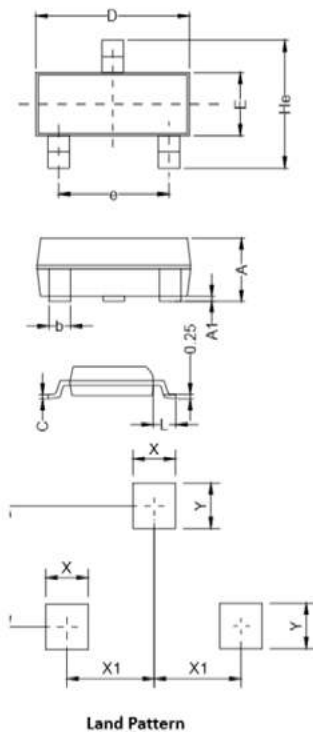

Dimension	Millimeters		Inches	
	Minimum	Maximum	Minimum	Maximum
A	0.90	1.15	0.035	0.045
A1	0.00	0.10	0.000	0.004
b	0.25	0.325	0.010	0.013
C	0.22	0.25	0.009	0.010
D	2.80	3.00	0.110	0.118
e	1.80	1.90	0.071	0.075
E	1.20	1.40	0.047	0.055
L	0.30	0.50	0.012	0.020
He	2.25	2.55	0.089	0.100
X	0.80		0.031	
X1	0.95		0.037	
Y	0.80		0.031	
Z	2.02		0.080	

Part marking

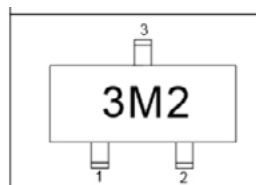

Packaging information mm/inches

Drawing not to scale.

Supplied in tape and reel packaging, 3,000 parts per 7" diameter reel (EIA-481 compliant)

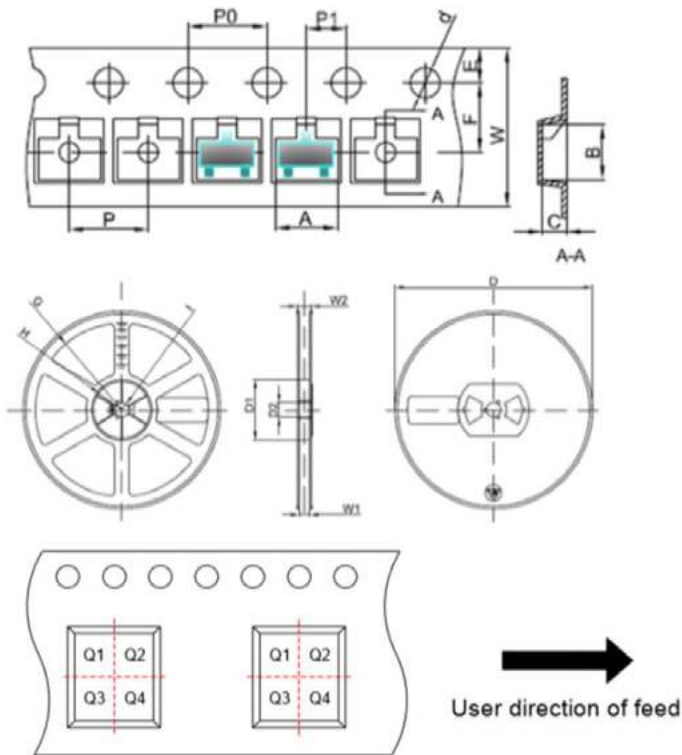

Pin 1 quadrant: Q3

Symbol	Millimeters	Inches
	Typ.	Typ.
A	3.15	0.124
B	2.77	0.109
C	1.22	0.048
d	Φ1.50	Φ0.059
E	1.75	0.069
F	3.50	0.138
P0	4.00	0.157
P	4.00	0.157
P1	2.00	0.079
W	8.00	0.315
D	Φ178	Φ7.008
D1	54.40	2.142
D2	13.00	0.512
G	R78.00	R3.071
H	R25.60	R1.008
I	R6.50	R0.256
W1	9.50	0.374
W2	12.30	0.484

Ratings and V-I characteristic curves (+25 °C unless otherwise noted)

V- I curve characteristics (Uni-directional)

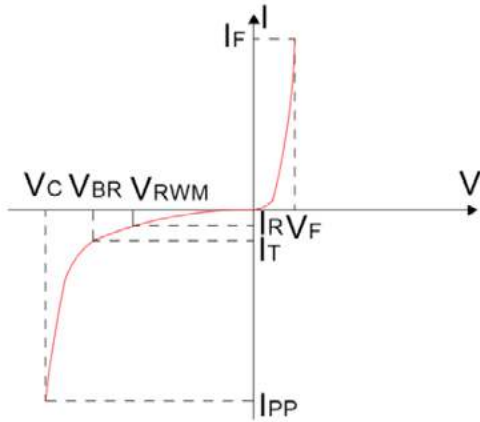

Pulse waveform (8/20 μs)

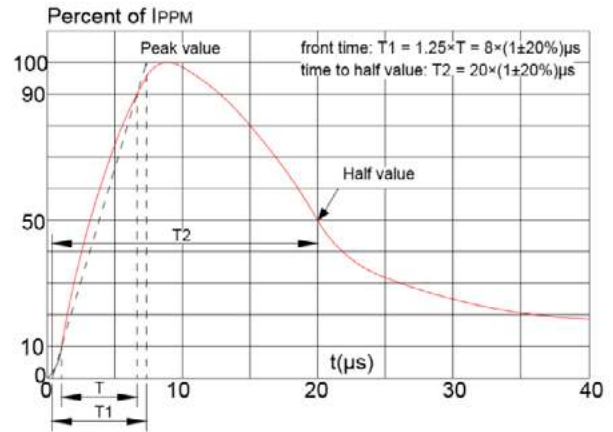

Pulse derating curve

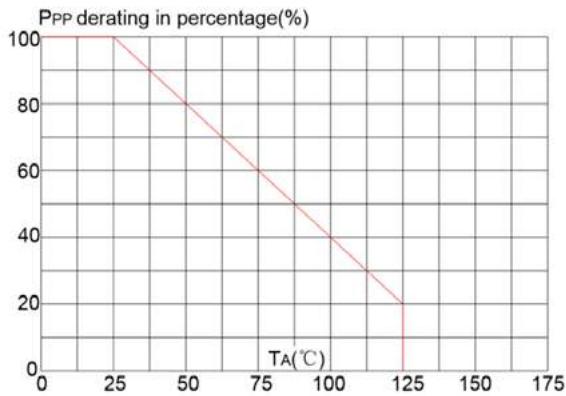

ESD waveform

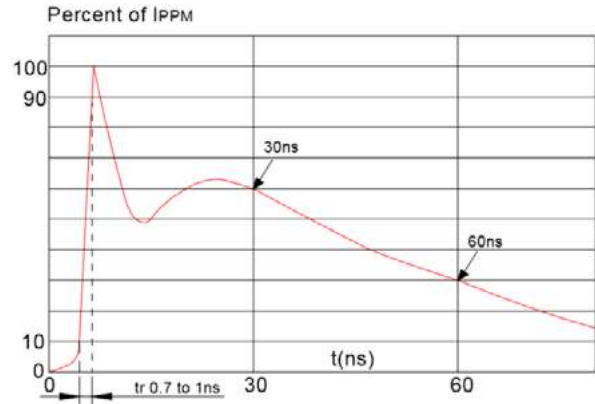

Solder reflow profile

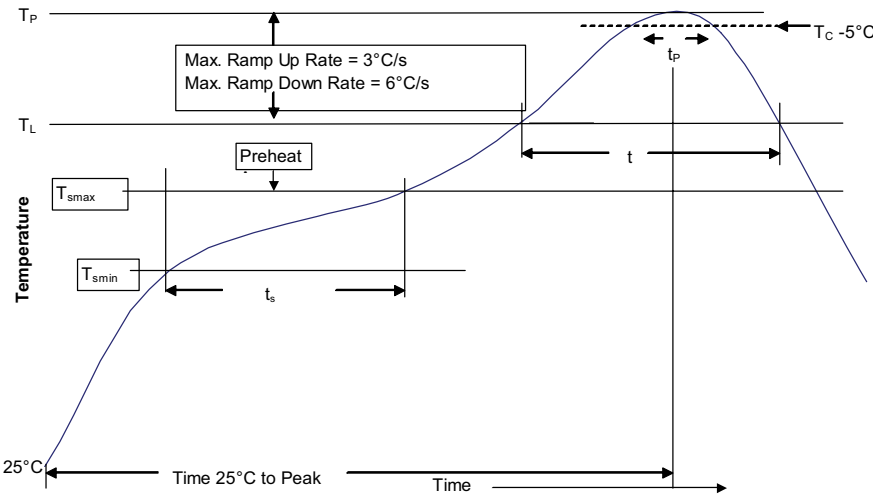

Table 1 - Standard SnPb solder (T_C)

Package thickness	Volume mm ³ <350	Volume mm ³ ≥350
<2.5 mm	235 °C	220 °C
≥2.5 mm	220 °C	220 °C

Table 2 - Lead (Pb) free solder (T_C)

Package thickness	Volume mm ³ <350	Volume mm ³ 350 - 2000	Volume mm ³ >2000
<1.6 mm	260 °C	260 °C	260 °C
1.6 – 2.5 mm	260 °C	250 °C	245 °C
>2.5 mm	250 °C	245 °C	245 °C

Reference J-STD-020

Profile feature	Standard SnPb solder	Lead (Pb) free solder
Preheat and soak		
• Temperature min. (T _{smin})	100 °C	150 °C
• Temperature max. (T _{smax})	150 °C	200 °C
• Time (T _{smin} to T _{smax}) (t _s)	60-120 seconds	60-120 seconds
Ramp up rate T _L to T _p	3 °C/ second max.	3 °C/ second max.
Liquidous temperature (T _L)	183 °C	217 °C
Time (t _L) maintained above T _L	60-150 seconds	60-150 seconds
Peak package body temperature (T _p)*	Table 1	Table 2
Time (t _p)* within 5 °C of the specified classification temperature (T _C)	20 seconds*	30 seconds*
Ramp-down rate (T _p to T _L)	6 °C/ second max.	6 °C/ second max.
Time 25 °C to peak temperature	6 minutes max.	8 minutes max.

* Tolerance for peak profile temperature (T_p) is defined as a supplier minimum and a user maximum.

Life Support Policy: Eaton does not authorize the use of any of its products for use in life support devices or systems without the express written approval of an officer of the Company. Life support systems are devices which support or sustain life, and whose failure to perform, when properly used in accordance with instructions for use provided in the labeling, can be reasonably expected to result in significant injury to the user.

Eaton reserves the right, without notice, to change design or construction of any products and to discontinue or limit distribution of any products. Eaton also reserves the right to change or update, without notice, any technical information contained in this bulletin.

Eaton
Electronics Division
1000 Eaton Boulevard
Cleveland, OH 44122
United States
Eaton.com/electronics

© 2020 Eaton
All Rights Reserved
Printed in USA
Publication No. 11154 BU-MC20136
September 2020

Eaton is a registered trademark.
All other trademarks are property of their respective owners.

Follow us on social media to get the latest product and support information.

