

DESCRIPTION

The MP5016 is a protection device designed to protect circuitry on the output from transients on input. It also protects input from undesired shorts and transients coming from the output.

At startup, inrush current is limited by limiting the slew rate at the output. The slew rate is controlled by DV/DT pin setting and MODE pin setting.

The maximum load at the output is current limited. The magnitude of the current limit is controlled by an external resistor from ILIMIT to GND. There is a fixed 2.5A current limit when floating ILIMIT pin.

The output voltage is limited by output OVP function, the clamp voltage can be set by MODE pin connection.

The device is available in a QFN10 (1.5mm x 2mm) package.

ELECTRICAL SPECIFICATION

Parameter	Value	Units
Input Voltage	2.7 to 15	V
Current Limit	2.5	A
DV/DT Slew Rate	3.8	V/ms

FEATURES

- Wide 2.7V to 15V Continued Operating Input Range
- 26V Absolute Maximum Transient Input Voltage
- Selectable Over Voltage Clamp Threshold
- Fast Output OVP Response
- Integrated 43mΩ Power FET
- Adjustable Current-Limit or Fixed Current Limit when floating ILIMIT pin
- Soft Start Time Programmable through DV/DT pin and MODE pin
- Fast Response for Hard Short Protection
- OCP Hiccup Protection
- Thermal Shutdown and Auto Retry
- Available in QFN10 (1.5mmx2mm) Package

APPLICATIONS

- HDD, SSD
- Hot Swap
- Wireless Modem Data Cards
- PC Cards
- USB Power Distribution
- USB Protection
- USB3.1 Power Delivery

All MPS parts are lead-free, halogen free, and adhere to the RoHS directive. For MPS green status, please visit MPS website under Quality Assurance.

"MPS" and "The Future of Analog IC Technology" are Registered Trademarks of Monolithic Power Systems, Inc.

EV5016-QH-00A EVALUATION BOARD



(LxW)5.4cm×4.1cm

Board Number	MPS IC Number
EV5016-QH-00A	MP5016GQH

Current Limit vs. R_{LIMIT}

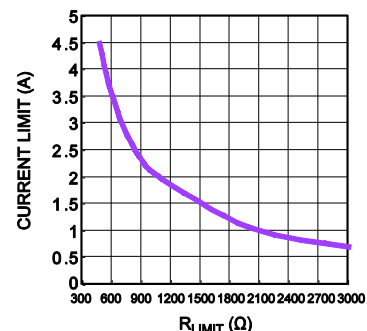

EVALUATION BOARD SCHEMATIC

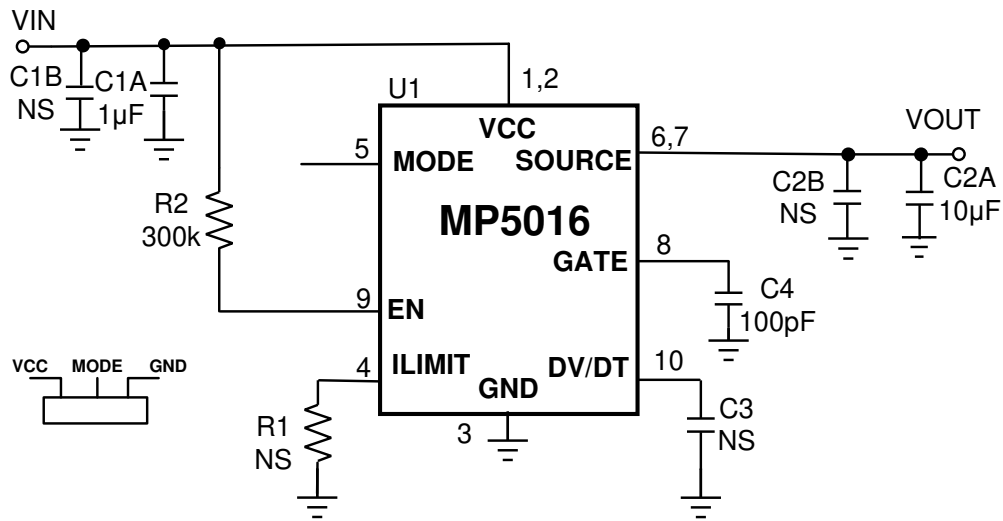

EV5016-QH-00A BILL OF MATERIALS

Qty	Ref	Value	Description	Package	Manufacturer	Manufacturer P/N
1	C1A	1µF	Ceramic Cap,25V,X5R	0805	Murata	GRM216R61E105KA12D
0	C1B, C2B, C3	NS				
1	C2A	10µF	Ceramic Cap,25V,X5R	0805	Murata	GRM21BR61E106KA73L
1	C4	100pF	Ceramic Cap,25V,X7R	0603	Murata	GRM1885C1H101JA01D
0	R1	NS				
1	R2	300K	1% resistor	0603	ROYAL	RL0603FR-07300KL
1	U1	MP5016	Electronic Fuse	QFN 1.5x2-10	MPS	MP5016GQH

EVB TEST RESULTS

$V_{IN}=5V$, $V_{OUT}=5V$, I_{LIMIT} pin float, $MODE$ pin float, DV/DT pin float, $C_{OUT}=10\mu F$, $T_A=25^\circ C$, unless otherwise noted.

Start-Up through Input Voltage
 $I_{LOAD}=0A$

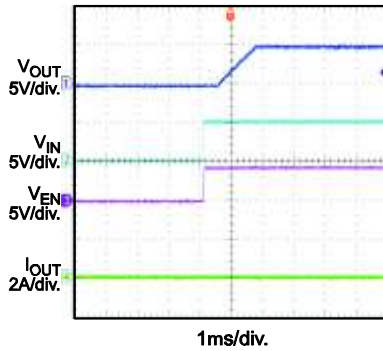

Start-Up through Input Voltage
 $I_{LOAD}=2A$

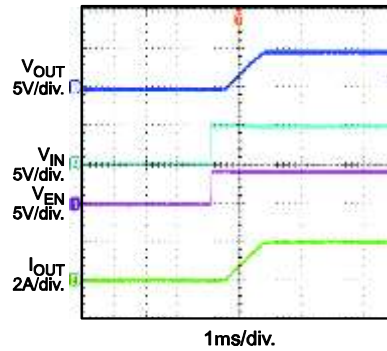

Start-Up through Input Voltage
 $I_{LOAD}=0A$, $C_{OUT}=1000\mu F$

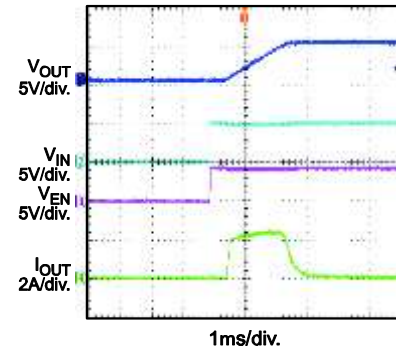

Start-Up through Enable
 $I_{LOAD}=0A$

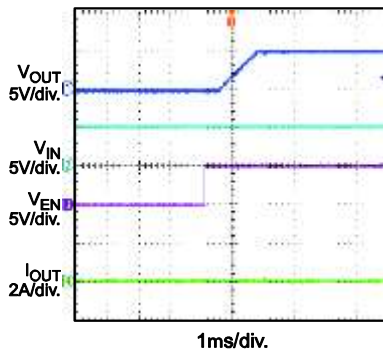

Start-Up through Enable
 $I_{LOAD}=2A$

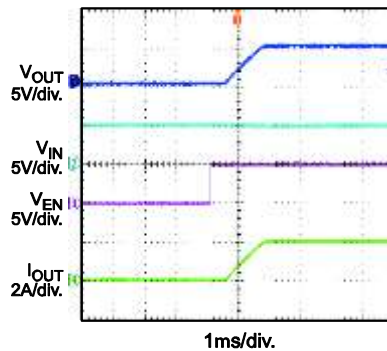

Start-Up through Enable
 $I_{LOAD}=0A$, $C_{OUT}=1000\mu F$

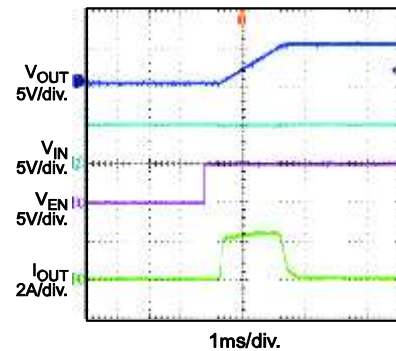

Shutdown through Input Voltage
 $I_{LOAD}=0A$

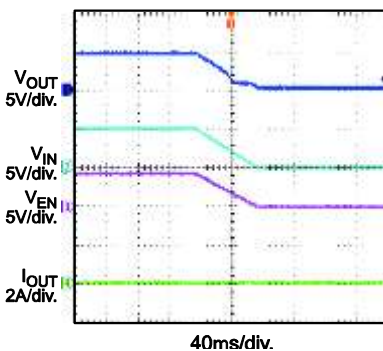

Shutdown through Input Voltage
 $I_{LOAD}=2A$

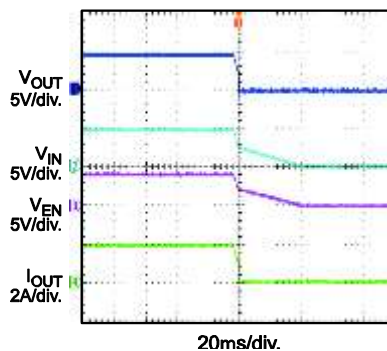

Shutdown through Enable
 $I_{LOAD}=0A$

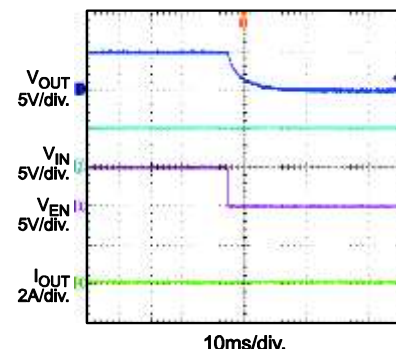

EVB TEST RESULTS

$V_{IN}=5V$, $V_{OUT}=5V$, I_{LIMIT} pin float, $MODE$ pin float, DV/DT pin float, $C_{OUT}=10\mu F$, $T_A=25^\circ C$, unless otherwise noted.

Shutdown through Enable
 $I_{LOAD}=2A$

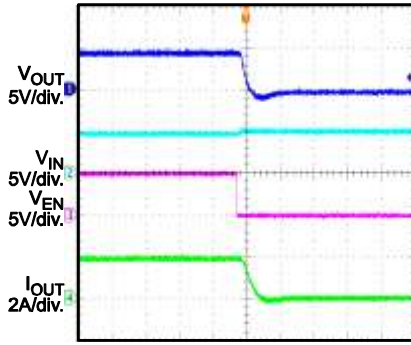

100µs/div.

Current Limit
 Increase I_{OUT} Slowly

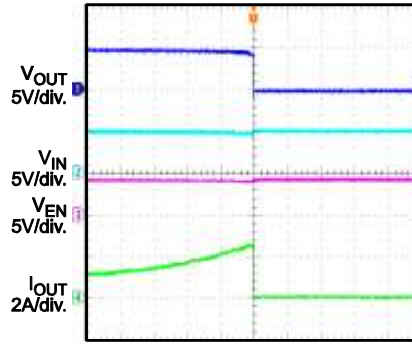

10ms/div.

Short Circuit during Normal Operation and Hiccup
 $I_{LOAD}=0A$

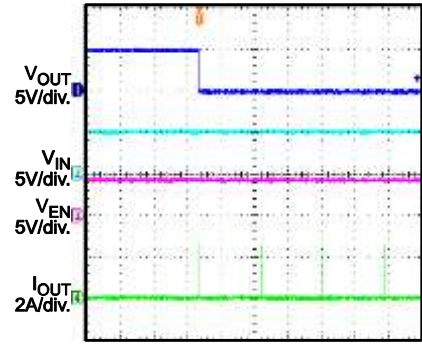

400ms/div.

Short Circuit Entry during Normal Operation
 $I_{LOAD}=0A$

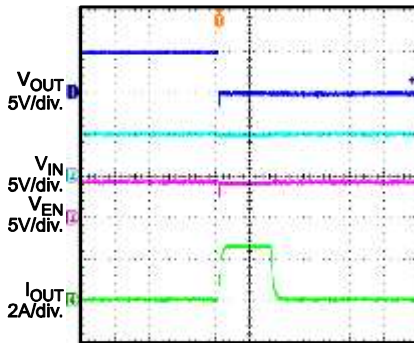

1ms/div.

CIRCUIT BOARD LAYOUT

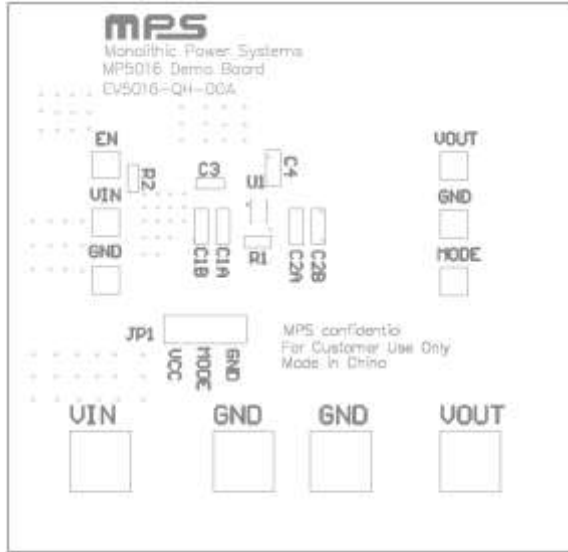

Figure 1: Top Silkscreen Layer

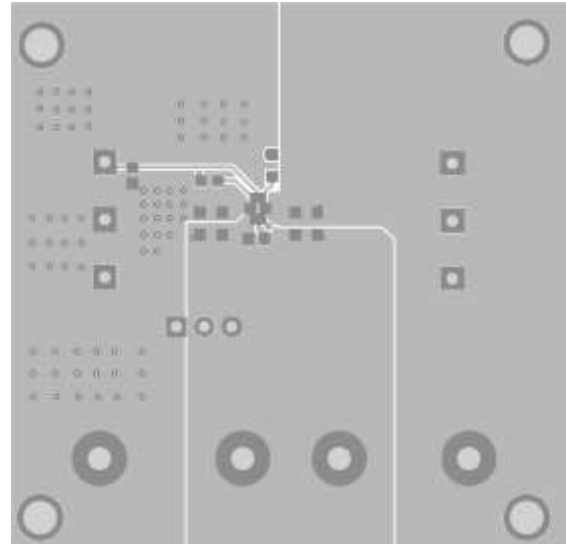

Figure 2: Top Layer

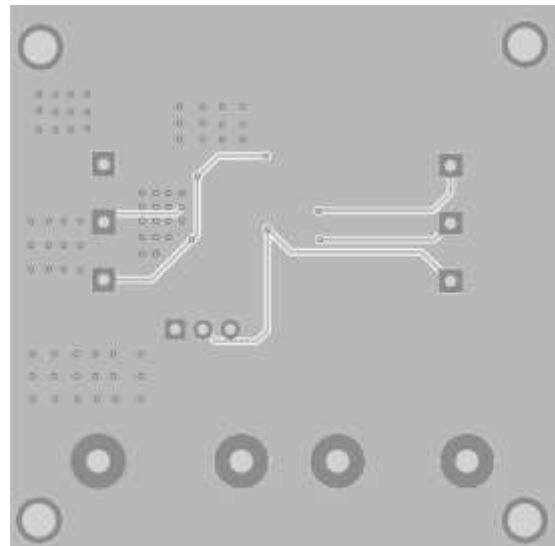

Figure 3: Bottom Layer

QUICK START GUIDE

1. Preset Power Supply to 2.7V-15V.
2. Turn Power Supply off.
3. Connect Power Supply terminals to:
 - a. Positive (+): VIN
 - b. Negative (–): GND
4. Connect Load to:
 - a. Positive (+): VOUT
 - b. Negative (–): GND
5. Turn Power Supply on after making connections. The board will automatically start up.
6. To use the Enable function, apply a digital input to the EN pin. Drive EN higher than 2.0V to turn on the regulator, or less than 1.6V to turn it off.
7. The default current limit is 2.5A (typical). To set different current limit, please choose proper R1. See details in MP5016 datasheet.

NOTICE: The information in this document is subject to change without notice. Please contact MPS for current specifications. Users should warrant and guarantee that third party Intellectual Property rights are not infringed upon when integrating MPS products into any application. MPS will not assume any legal responsibility for any said applications.