

TOSHIBA Bi-CMOS Integrated Circuit Silicon Monolithic

TB9056FNG

Automotive DC Servo Motor Driver

1. Description

TB9056FNG is an automotive DC servo motor driver. With a target motor rotational position supplied by the external LIN (Local Interconnect Network) signal, it measures the current motor position using a potentiometer and controls motor rotation so that its rotational position reaches to the target position. Up to 16 devices can be connected as slaves on a single bus.

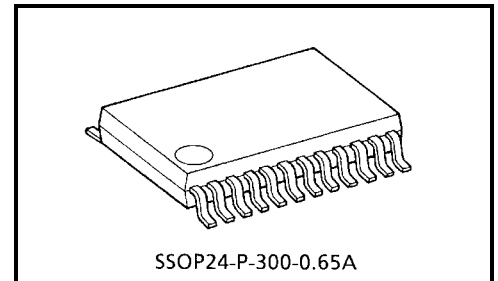

Weight: 0.13 g (typ.)

2. Applications

Automotive DC Servo Motor Driver

3. Features

- Data communications with LIN (slave)
- Communication rate: 19,200 / 9,600 / 4,800 / 2,400 bps (with switching pins)
- Based on LIN 1.3 Protocol Specification
- Bidirectional DC motor driver(H-bridge): 1 channel (R_{on} typ.: $Pch+Nch = 2.2 \Omega$)
- Driver short-circuit protection: ± 1.5 A (typ.)
- Over temperature and overvoltage protection circuits.
- Standby current consumption: 10 μ A or less
- Operating supply voltage range: 7 to 18 V
- Operating temperature range: -40 to 125°C
- Junction temperature (T_j max): 150 °C
- The product(s) is/are compatible with RoHS regulations (EU directive 2011 / 65 / EU) as indicated, if any, on the packaging label ("[[G]]/RoHS COMPATIBLE", "[[G]]/RoHS [[Chemical symbol(s) of controlled substance(s)]]", "RoHS COMPATIBLE" or "RoHS COMPATIBLE, [[Chemical symbol(s) of controlled substance(s)]]>MCV").

4. Block Diagram

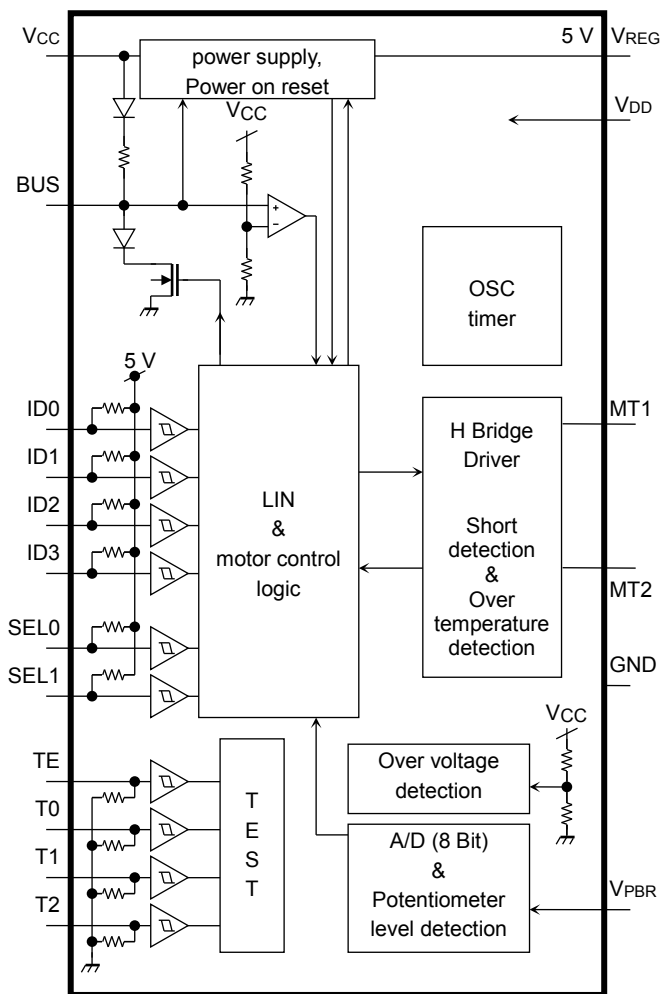

Figure 4.1 Block Diagram

5. Pin Assignments

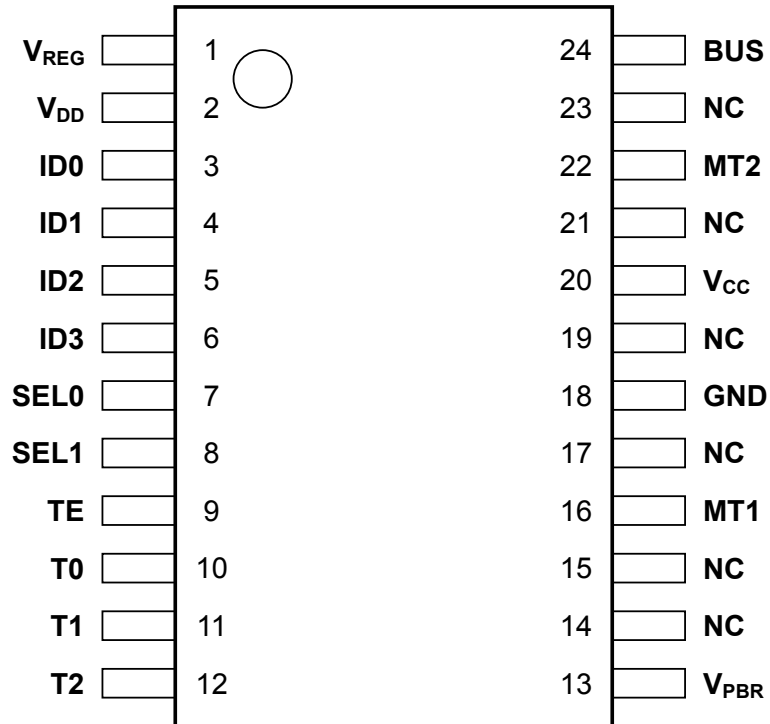

Figure 5.1 Pin Assignments (top view)

6. Pin Description

6.1. Pin Table

Table 6.1 Pin Description

Pin No.	Symbol	Description	Structure	IN, OUT	Remarks
1	V _{REG}	5 V power supply output	Bip	OUT	-
2	V _{DD}	CMOS power supply input	CMOS	-	-
3	ID0	Address setup pin 0	CMOS	IN	50 kΩ pull-up
4	ID1	Address setup pin 1	CMOS	IN	50 kΩ pull-up
5	ID2	Address setup pin 2	CMOS	IN	50 kΩ pull-up
6	ID3	Address setup pin 3	CMOS	IN	50 kΩ pull-up
7	SEL0	Baud rate setup pin 0	CMOS	IN	50 kΩ pull-up
8	SEL1	Baud rate setup pin 1	CMOS	IN	50 kΩ pull-up
9	TE	Test enable input	CMOS	IN	50 kΩ pull-down
10	T0	Test pin 0	CMOS	IN	50 kΩ pull-down
11	T1	Test pin 1	CMOS	IN	50 kΩ pull-down
12	T2	Test pin 2	CMOS	IN	50 kΩ pull-down
13	V _{PBR}	Potentiometer signal input	Bip	IN	2.5 MΩ pull-up
14	NC	-	-	-	Should be left open
15	NC	-	-	-	Should be left open
16	MT1	Driver 1 output	HVMOS	OUT	-
17	NC	-	-	-	Should be left open
18	GND	GND pin	-	-	-
19	NC	-	-	-	Should be left open
20	V _{CC}	12 V power supply	-	-	-
21	NC	-	-	-	Should be left open
22	MT2	Driver 2 output	HVMOS	OUT	-
23	NC	-	-	-	Should be left open
24	BUS	LIN input/output	Bip / MOS	IN / OUT	30 kΩ pull-up

Note: NC means Non Connect pin.

Note: Design of printed circuit board and notes on testing

Pin No. 2 to 12 have a withstand voltage of 6V. Pay attention not to connect or short to the pins like V_{CC}, MT1, 2, BUS which have a higher withstand voltage.

Although it may operate normally when shorting between adjacent pins or opening a pin, there could be an abnormal operation, non-operation or a different operation from setting. Therefore, after mounting, please be sure to verify that all parts are properly connected electrically and securely

6.2. Pin Equivalent Circuits

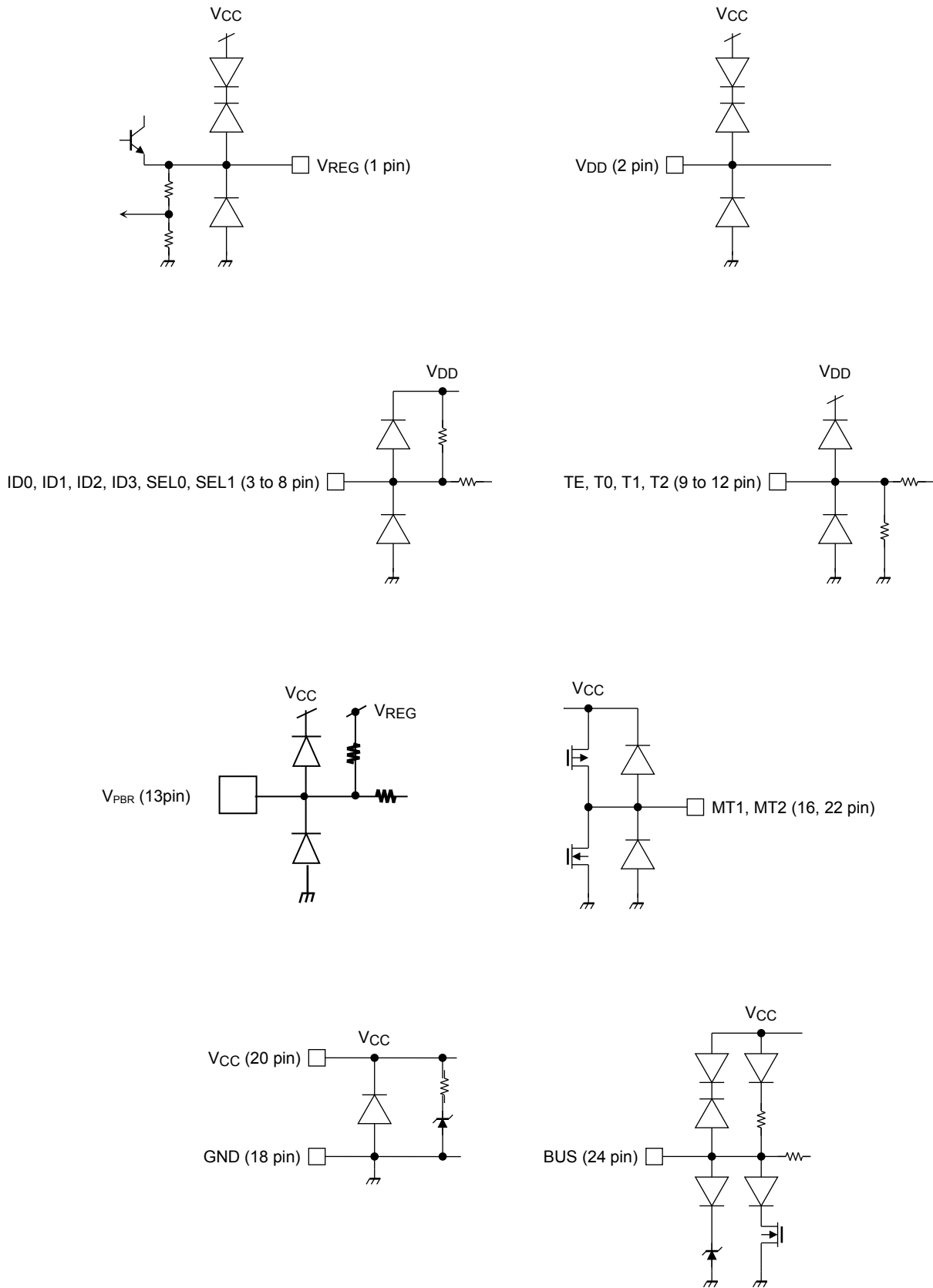

Figure 6.1 Pin Equivalent Circuits

7. Functional Descriptions

7.1. Example System Configuration

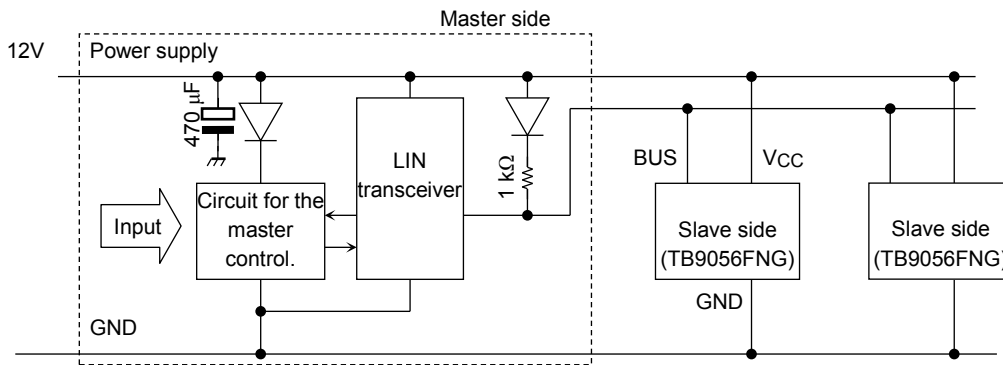

Figure 7.1 Example System Configuration

7.1.1. Example Slave Application Circuit

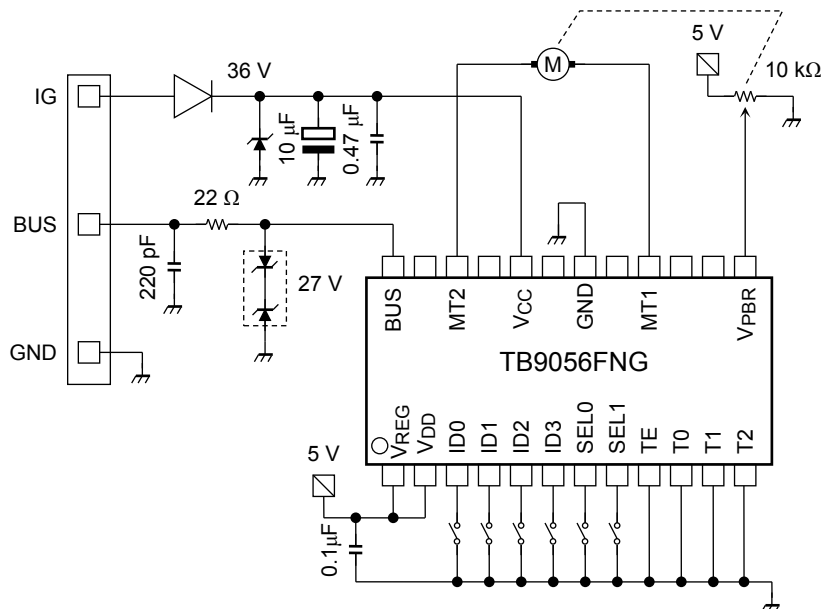

Figure 7.2 Example Slave Application Circuit

7.1.2. Baud Rate Settings

Table 7.1 Baud Rate

Unit: bps

SEL0	SEL1	Baud rate
0	0	2,400
1	0	4,800
0	1	9,600
1	1	19,200

Note 1: Open , 0: GND short

7.1.3. Slave ID Settings

Table 7.2 Slave ID

ID0	ID1	ID2	ID3	Node ID No.
0	0	0	0	0
1	0	0	0	1
0	1	0	0	2
1	1	0	0	3
0	0	1	0	4
1	0	1	0	5
0	1	1	0	6
1	1	1	0	7
0	0	0	1	8
1	0	0	1	9
0	1	0	1	10
1	1	0	1	11
0	0	1	1	12
1	0	1	1	13
0	1	1	1	14
1	1	1	1	15

Note 1: Open , 0: GND short

7.1.4. Example Communication Sequences

7.1.4.1. Example Control Sequence with Two Slaves (9,600 bps)

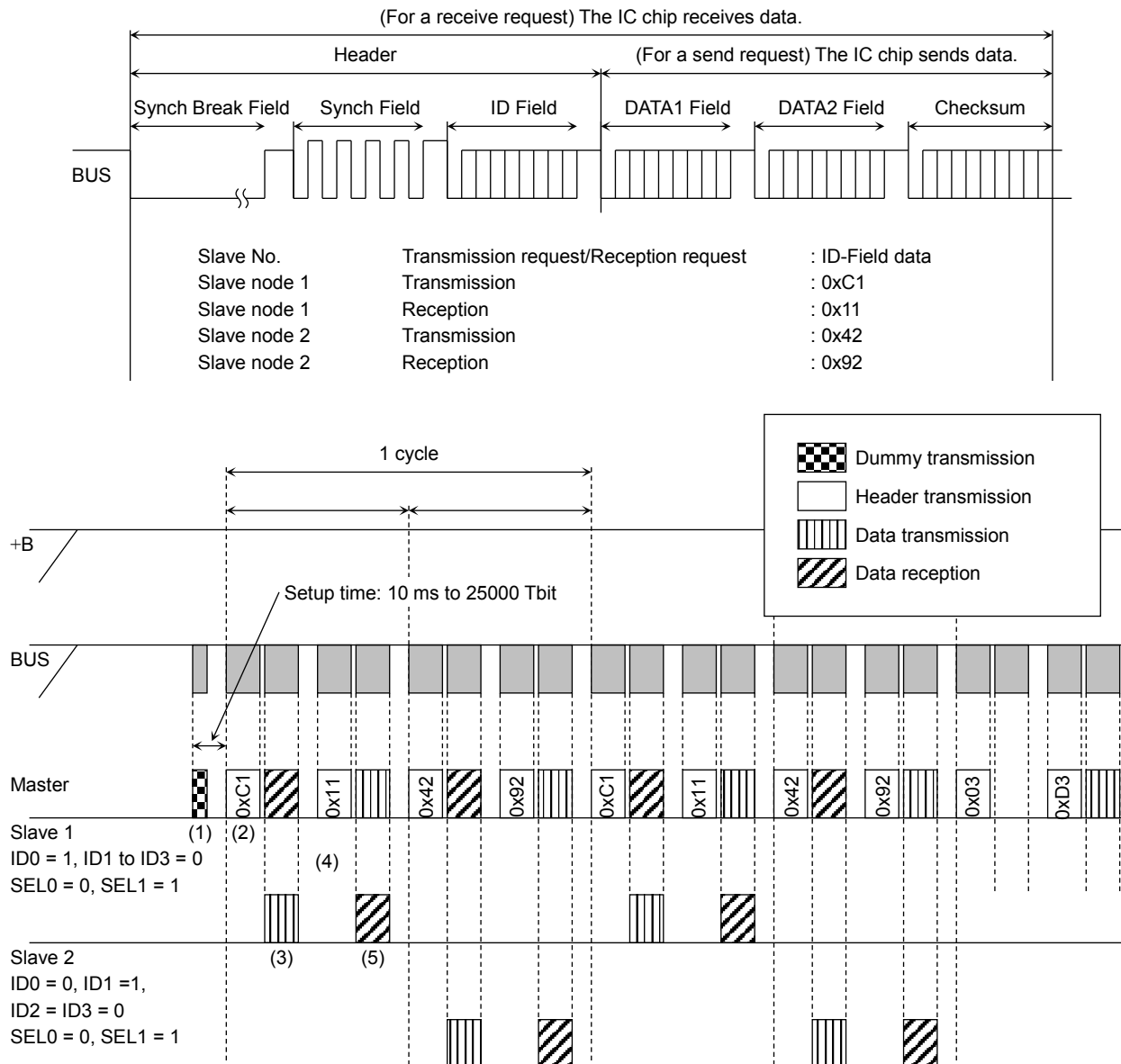

Figure 7.3 Example Control Sequence with Two Slaves (9600 bps)

- (1) The master sends a dummy signal. (Slaves wake up upon receiving a dummy signal.)
- (2) The master sends a header (0xC1). (Requests a reply in order to obtain the status of slave 1.)
- (3) The slave with pin ID0 = 1 and pins ID1 to ID3 = 0 sends a reply.
The master receives the reply data.
- (4) The master sends a header (0x11). (Requests slave 1 to receive data.)
- (5) And the master sends a setting data. (Slave 1 receives the data.)
and so on

Abbreviation:

Tbit(Time bit): Time unit per 1 bit, which depends on the baud rate.

7.1.5. DATA1 and DATA2 Fields

7.1.5.1. Definition of DATA Frame

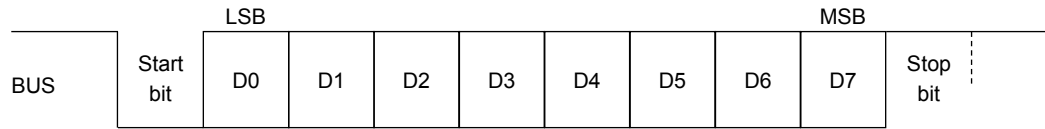
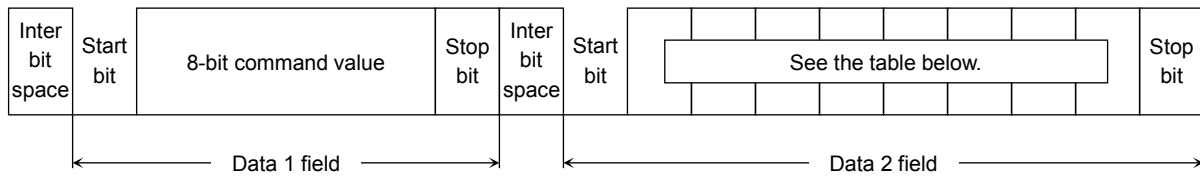

Figure 7.4 DATA Frame

7.1.5.2. Reception Request: The Master Requests a Slave to Receive Data



D0	Request to clear a communication error flag	D4	Specify the maximum duty ratio: 16/16, 11/16, 7/16, 4/16
D1	Request to clear a diagnosis flag	D5	
D2	Request to apply output PWM control when starting the motor or before stopping the motor	D6	Request to stop the motor in emergency
D3	Toggle PWM torque control time either 500 or 250 ms	D7	Request to recover the motor operation

Please refer to "7.3.5 Description of Request in DATA2 Field" for details

Figure 7.5 Reception Request

7.1.5.3. Transmission Request: The Master Requests a Slave to Transmit Data

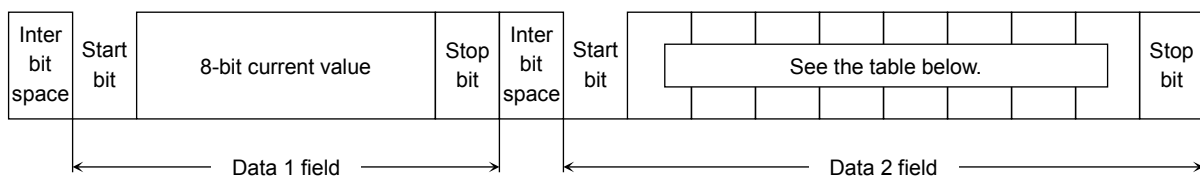

D0	Over current detection flag (Detect motor current of approx. 1.5 A or higher)	D4	Received ID parity error flag
D1	Motor stopped flag (MT1 = Low, MT2 = Low)	D5	Over temperature detection flag
D2	CW (normal rotation: MT1 = High, MT2 = Low)	D6	Received checksum error flag
D3	CCW (reverse rotation: MT1 = Low, MT2 = High)	D7	Overvoltage detection flag (V _{CC} potential = 26 V(typ.) or higher)

Please refer to "7.4.4 Description of Transmit DATA2 Field and Related Operations" for details

Figure 7.6 Transmission Request

7.1.5.4. Details of checksum

Please refer to "7.2 Sequence Description".

7.1.6. Motor Output and AD Operation: Example

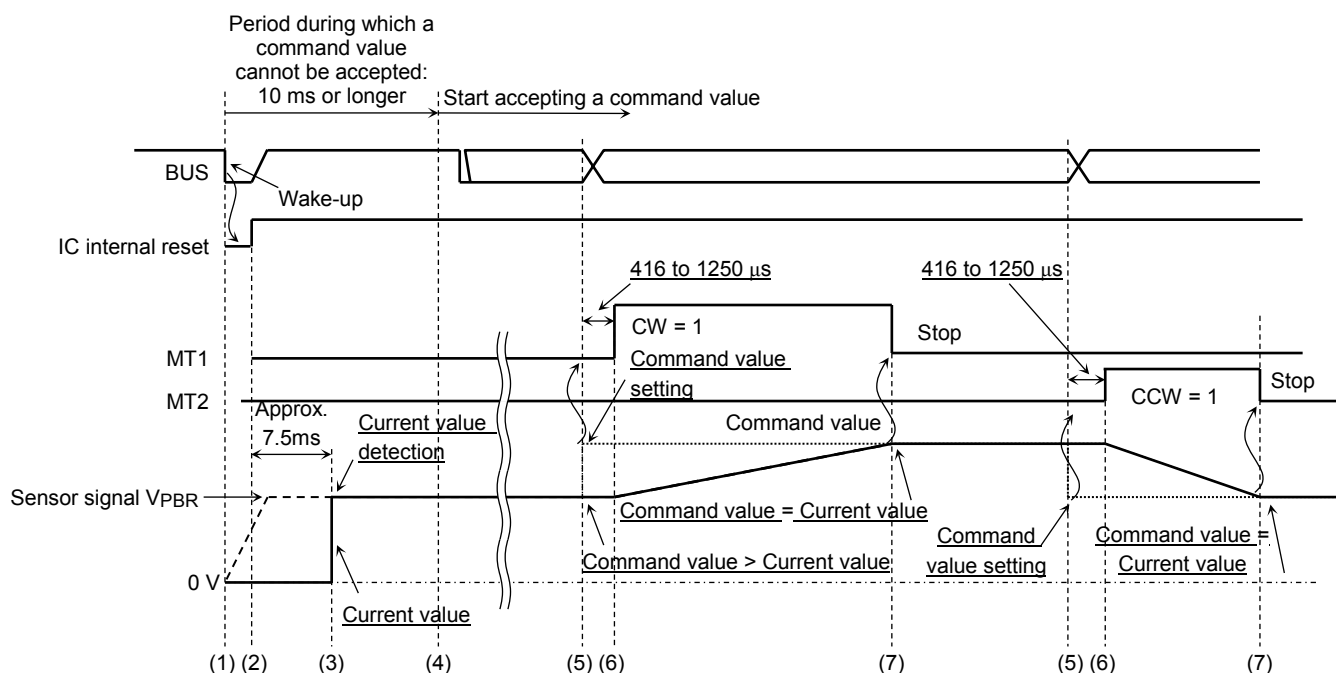

Figure 7.7 Motor Output and AD Operation

- (1) The master sends a dummy signal. Each node receives it and start to wake-up. The 5 V power supply will be started.
- (2) Initialization
- (3) Obtain the voltage measured with the potentiometer (determined in 7.5 ms after reset of 4 MHz oscillation).
- (4) Start accepting the receive data (after starting wake-up, the device should wait at least 10 ms before starting communication, considering the time required for oscillation to stabilize).
- (5) Receive a command value (the above example shows two cases: command value > current value and command value < current value).
- (6) Turn the driver on after 416 to 1,250 μs.
- (7) Stop the motor (when the command value equals to the current value).
Wait for a next command (enter the standby mode if BUS remains High longer than 25,000 Tbit).

7.2. Sequence Description

7.2.1. Standby Release Sequence

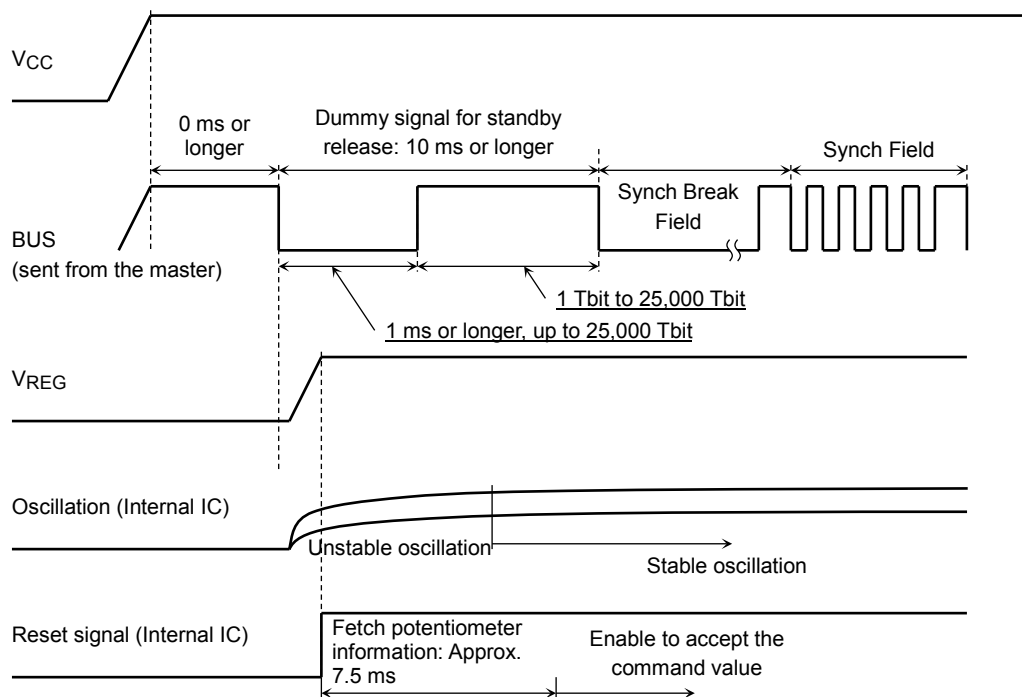

Figure 7.8 Standby Release Sequence

At power up the IC's state is not defined. Accordingly after power on it may be in one of both states, either standby or normal operation.

When the BUS level falls to V_{BUSSTB} , it starts the output of V_{REG} and operation of bipolar circuit. Then the device is released from the standby state. After the reset, the time until detecting the voltage of potentiometer is approximately 7.5 ms, and the command which received during the time is ignored.

When monitoring the time of standby release in the slave, there may be a timing error due to the unstable starting time of V_{DD} and oscillation.

Communication should, therefore, start at least 10 ms after the dummy signal is sent for releasing standby. If the BUS does not change its state for 25,000Tbit after once it falls and rises, the slave returns to the standby state.

7.2.2. Entering the Standby State

If the BUS level goes high and does not change for 25,000 Tbit, the slave enters the standby state.

If there is a standby demand while the motor driver is in operation, it enters the standby state after finish the motor driver operation. It doesn't enter the standby state when the BUS voltage is Low.

Note: If communication is not established between the master and the slave with its specified ID, the baud rate is not adjusted. Therefore, standby detection time may include an error of up to $\pm 15\%$.

Once communication is established, the baud rate can be adjusted using the data of previous communication, even if communication is not established.

7.2.3. Setting the Communication Baud Rate

By setting the SEL0 and SEL1 pins, select one of the following baud rates:

Table 7.3 Communication Baud Rate

		Unit (bps)
SEL0	SEL1	Baud rate
Low (0)	Low (0)	2,400
Open (1)	Low (0)	4,800
Low (0)	Open (1)	9,600
Open (1)	Open (1)	19,200

7.2.3.1. Definition of Synch Break Field

(Example: Sending 80h data with half of the normal baud rate, from the master UART, then restore the baud rate to normal. as a result, the following signal is obtained.)

(Sent from outside of the IC)



Figure 7.9 Synch Break Field

- Time monitoring on the slave starts with the falling edge of the Sync Break Field. Because the baud rate cannot be adjusted until communication is established, time within the IC depends on variations in CR oscillation on the slave and thus includes an error. (Once communication has been established, the communication baud rate is adjusted so that time will be aligned with the baud rate.)
- A Synch Break Field is recognized if a signal having longer than 11 Tbit between a falling edge and the next rising edge on BUS is detected. Once a Synch Break Field has been recognized, the IC cannot be used for any processing during 1 to 13 Tbit before the next BUS falling edge. If it does not detect a BUS falling edge for a certain time period, it waits until it detects a Synch Break Field again.

7.2.3.2. Synch Field

(Example: Sending 55h data with baud rate from UART)

(Sent from outside of the IC)

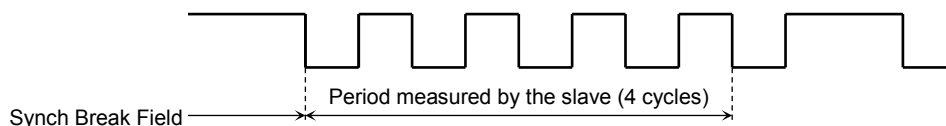

Figure 7.10 Synch Field

The slave counts time of four cycles from the next falling edge after it recognizes a Synch Break Field (that falling edge is likely to be a Synch Field). It uses 1/8 (baud rate) of the counted time as a tentative clock and fetches data from the next falling edge (likely to be an ID field).

7.2.4. Data Fetch Timing

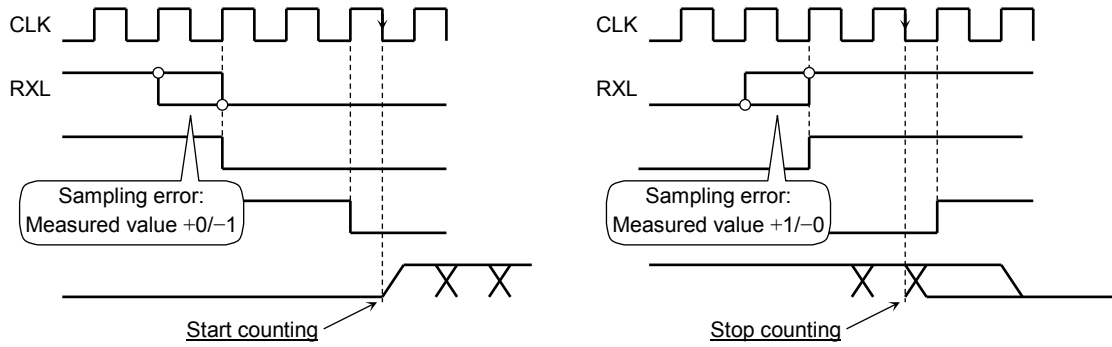

Figure 7.11 Data Fetch Timing

Abbreviation:

CLK: Basic clock of internal LIN IC

RXL: Digital I/F signal, which is received from the receiver of internal IC.

DA: Counter value for adjusting baud rate of internal IC.

7.2.4.1. Synch Field

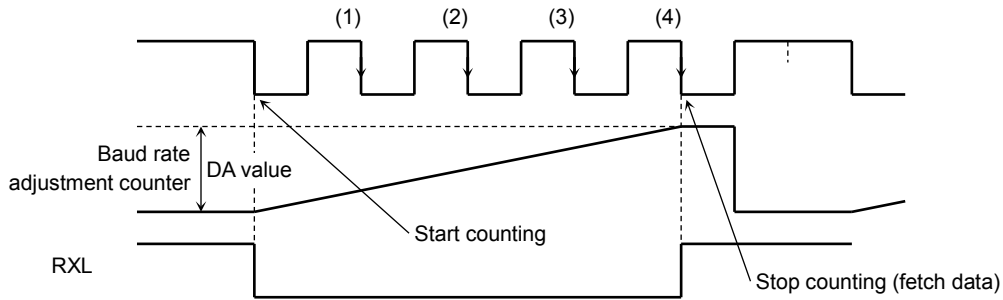

Figure 7.12 Synch Field Timing

7.2.4.2. ID Field

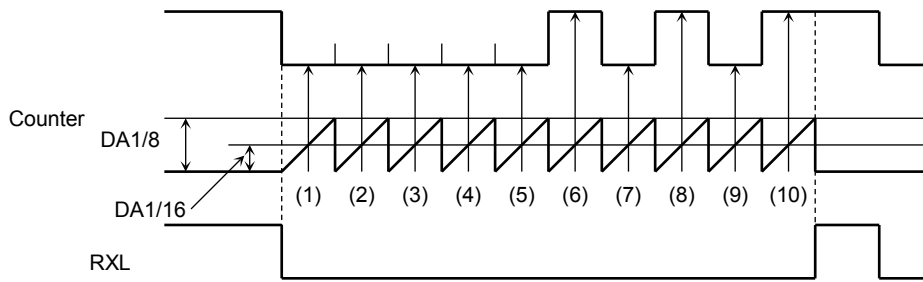

Figure 7.13 ID Field Timing

The counter increases until it becomes the DA1/8 value. In the middle of that period, at DA1/16, it reads RXL data. And at DA1/8, it clears the data. Then, increase the counter by one and repeat the operation until counter becomes ten. If the data in the ID Field passes the parity check, the DA1/8 value in the counter is used.

If the parity check fails, the slave performs nothing and waits until it detects a next Synch Break Field. (If its ID is specified, the slave sets the error flag.)

7.2.5. Definition of ID Field

(Sent from outside of the IC)

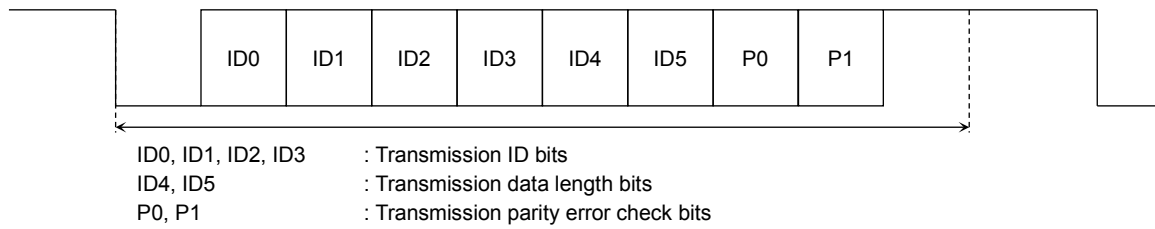

Figure 7.14 Definition of ID Field

Table 7.4 ID Assignment Table

Pin settings: Open = 1, Low = 0

	ID0	ID1	ID2	ID3	ID4	ID5	P0	P1	Transmission/ Reception
0	0	0	0	0	0	0	0	1	Transmission request
1	1	0	0	0	0	0	1	1	
2	0	1	0	0	0	0	1	0	
3	1	1	0	0	0	0	0	0	
4	0	0	1	0	0	0	1	1	
5	1	0	1	0	0	0	0	1	
6	0	1	1	0	0	0	0	0	
7	1	1	1	0	0	0	1	0	
8	0	0	0	1	0	0	0	0	
9	1	0	0	1	0	0	1	0	
10	0	1	0	1	0	0	1	1	
11	1	1	0	1	0	0	0	1	
12	0	0	1	1	0	0	1	0	
13	1	0	1	1	0	0	0	0	
14	0	1	1	1	0	0	0	1	
15	1	1	1	1	0	0	1	1	
16	0	0	0	0	1	0	1	0	Reception request
17	1	0	0	0	1	0	0	0	
18	0	1	0	0	1	0	0	1	
19	1	1	0	0	1	0	1	1	
20	0	0	1	0	1	0	0	0	
21	1	0	1	0	1	0	1	0	
22	0	1	1	0	1	0	1	1	
23	1	1	1	0	1	0	0	1	
24	0	0	0	1	1	0	1	1	
25	1	0	0	1	1	0	0	1	
26	0	1	0	1	1	0	0	0	
27	1	1	0	1	1	0	1	0	
28	0	0	1	1	1	0	0	1	
29	1	0	1	1	1	0	1	1	
30	0	1	1	1	1	0	1	0	
31	1	1	1	1	1	0	0	0	

The slave enters reception or transmission mode if it receives any of the IDs shown in the above table and if its ID0 to ID3 pin settings coincide with the ID0 to ID3 settings for the received ID. If it receives an ID other than the above, it ignores the ID. The initially configured communication mode is a transmission request mode.

7.2.6. Setting the Data Length (bytes)

The TB9056FNG is designed specifically for a data length of two bytes and assigned transmission or reception using the data on ID4 and ID5. It ignores any data having a length of other than two bytes (assumes that the data is not for the ID).

Table 7.5 Specifying the Data Length

ID4	ID5	Data length (bytes)	Operation
0	0	2	Transmission request
1	0	2	Reception request
0	1	4	Nothing
1	1	8	Nothing

The TB9056FNG uses a length of two bytes with ID4 = 0 or 1 and ID5 fixed to 0. Transmission or reception is selected as follows:

If its ID is received with ID4 = 0 and ID5 = 0, the slave transmits data frames after the ID frame.
If its ID is received with ID4 = 1 and ID5 = 0, the slave receives data frames after the ID frame.

7.2.6.1. Filtering

The slave compares the data received on ID0 to ID5 with its own ID and, if they match, it assumes the ID is correct for the communication. Otherwise, it ignores subsequent data. (In some cases, ID0 to ID3 match but ID4 and ID5 do not.)

7.2.6.2. ID Parity Error Check

Using the received ID0 to ID5 data, the slave generates P0 and P1 from the following expressions and compares it with received P0 and P1. If they do not match, it assumes a parity error and sets the parity error flag. (The result is also used to determine whether to perform baud rate adjustment)

$$P0 = ID0 + ID1 + ID2 + ID4 \quad P1 = ID1 + ID3 + ID4 + ID5$$

The slave ID is specified by connecting the ID0, ID1, ID2, and ID3 pins to GND or to leave them open. The pins connected to GND set the corresponding ID bits to 0 and those left open set the bits to 1. ID4 and ID5 are not provided as IC pins but fixed within the IC.

If neither Start bit nor Stop bit is normal, the IC sets both the parity error flag and the check sum error flag.

If the slave has normally completed the above reception sequence and the ID is correct for the communication, it can adjust the baud rate.

Baud rate adjustment is required for each communication. If an error occurs during a communication, the slave operates the communication by using the previously adjusted baud rate data.

7.3. Reception Request Signal

If the slave receives a signal that specifies its ID with ID4 = 1 and ID5 = 0, and without a parity error, it handles the signal as a reception request signal.

If it receives a signal that specifies other than its ID or if it receives its ID but a parity error occurs, it ignores subsequent signals it receives. (If a parity error occurs, the slave does not subsequently monitor a checksum error.)

7.3.1. DATA1 Field

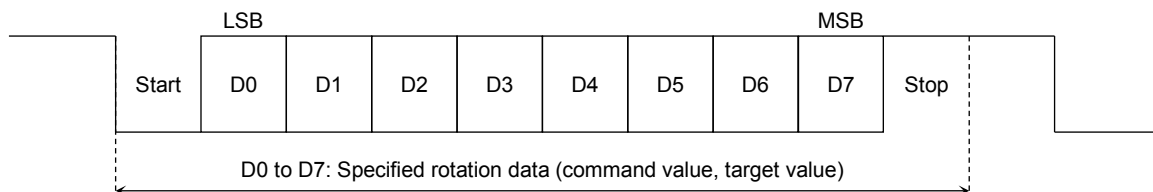

Figure 7.15 DATA1 Field

When the start bit = 0 and the stop bit = 1, the data in D0 to D7 is stored in temporary register DATA1. This data is a data field used to specify a target motor rotation value (specified rotation data or command value).

When the start bit = 1 or the stop bit = 0, the slave discards received data and sets both the parity error flag and checksum error flag. At the initialization, the field is cleared to 00h.

Please refer to “7.3.4. Description of Request in the DATA1 Field” for details

7.3.2. DATA2 Field

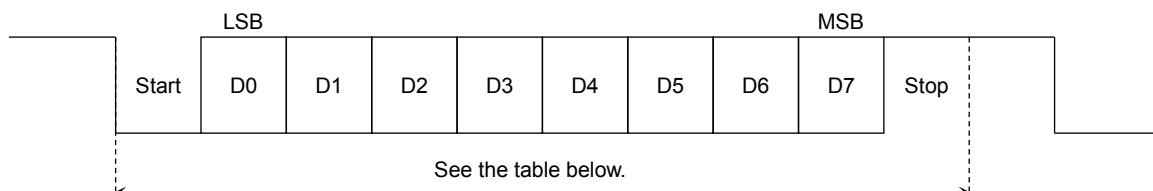

D0	Request to clear a communication error flag	D4	Specify the maximum duty ratio: 16/16, 11/16, 7/16, 4/16
D1	Request to clear a diagnosis flag	D5	
D2	Request to apply output PWM control when starting the motor or before stopping the motor	D6	Request to stop the motor in emergency
D3	Toggle PWM torque control time either 500 or 250 ms	D7	Request to recover the motor operation

Figure 7.16 DATA2 Field

When the start bit = 0 and the stop bit = 1, the data in D0 to D7 is stored in temporary register DATA2. When the start bit = 1 or the stop bit = 0, the slave discards received data and sets both the parity error and checksum error flags. At initialization, the field is cleared to 00h.

Please refer to “7.3.5. Description of Request in DATA2 Field” for details

7.3.3. Checksum Field

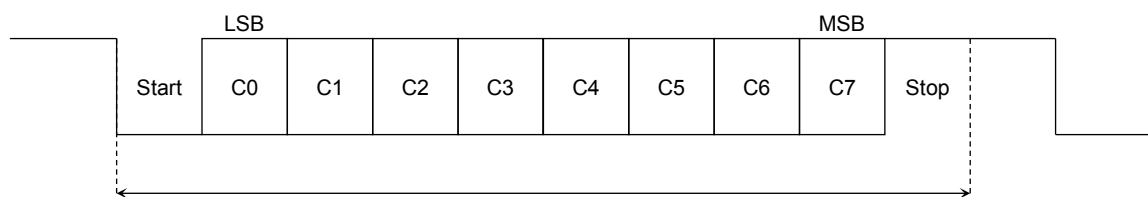

Figure 7.17 Checksum Field

When the start bit = 0 and the stop bit = 1, the slave stores the values of C0 to C7 in temporary register CSM. Then, it obtains the sum of 8 Tbit in temporary register DATA1, 8 Tbit in temporary register DATA2, a carry, and 8 Tbit in temporary register CSM. And checks that the sum equals to FFh. If it is FFh (no error), it stores data from temporary registers DATA1 and DATA2 as official data.

If the sum does not equal to FFh, the slave assumes a checksum error and discards the received data. If the start bit or stop bit is not valid, the slave sets both the parity error flag and checksum error flag.

7.3.4. Description of Request in the DATA1 Field

DATA1 contains the specified rotation data (command value) the master has requested.

If no checksum error occurs, the slave compares the newly stored DATA1 data with that stored previously. If they differ, the slave performs the following steps:

Case 1:

Compare the newly stored DATA1 data with the current data (AD converted potentiometer position data), and if the new data is larger, output of the motor driver pin MT1 becomes High and the MT2 becomes Low. Also set the normal rotation (CW) flag to 1 and the motor stopped flag to 0.

The motor driver compares the newly stored DATA1 data with the current data (AD converted potentiometer position data) and continues driving until the current data equals to the newly stored DATA1 data. Then stop it by outputting Low at MT1 and MT2. At the same time, it clears the CW and CCW flags to 0 and sets the motor stopped flag to 1.

Note: The motor driver stops driving the motor when the current data equals to the newly stored DATA1 data but the current data may become slightly larger due to the inertia of the motor.

Case 2:

Compare the newly stored DATA1 data with the current data (AD converted potentiometer position data), and if the new data is smaller, output of the MT2 motor driver pin becomes High and the MT1 pin becomes Low. Also set the reverse rotation (CCW) flag to 1 and the motor stopped flag to 0.

The motor driver compares the newly stored DATA1 data with the current data (AD converted potentiometer position data) and continues driving until the current data equals to the newly stored DATA1 data. Then stop it by outputting Low at MT1 and MT2. At the same time, it clears the CW and CCW flags to 0 and sets the motor stopped flag to 1.

Note: The motor driver stops driving the motor when the current data equals to the newly stored DATA1 data but the current data may become slightly smaller due to the inertia of the motor.

Case 3:

Compare the newly stored DATA1 data with the current data (AD converted potentiometer position data), and if they are equal, output of the MT1 and MT2 motor driver pins become Low. Also set the normal rotation (CW) and reverse rotation (CCW) flags to 0 and the motor stopped flag to 1.

7.3.4.1. Special Rotation data (command value) Request

If the Request of Motor Recovery Operation is 1 and specified rotation data (command value) is 00h, it regards as a request of a forced motor rotation to CCW, regardless of the current data of potentiometer. The rotation continues until receiving Request to Stop the Motor in Emergency, occurring a Diagnosis Flag or moving into standby mode.

And if the Request of Motor Recovery Operation is 1 and specified rotation data (command value) is FFh, it regards as a request of a forced motor rotation to CW, regardless of the current data of potentiometer. The rotation continues until receiving Request to Stop the Motor in Emergency, occurring a Diagnosis Flag or moving into standby mode.

If the Special Rotation data (command value) is requested, the IC operate as DATA Field D2(Low-speed Start/stop) = 0 even if D2 = 1 (PWM control cannot be used when the IC is in turning-on stage or turning-off stage.). But the DATA Field D4 and D5(Change the maximum value of PWM Duty) can be used.

7.3.5. Description of Request in DATA2 Field

- D0: Request to Clear a Communication Error Flag

When the slave receives this request, it clears the ID parity error flag and reception checksum error flag, which comes from an error of previously received data.	1	Request to clear
	0	Cause nothing

- D1: Request to Clear a Diagnosis Flag

When the slave receives this request, it clears any protective detection flags that have been set upon the detection of over current, over temperature, or overvoltage within the IC.	1	Request to clear
	0	Cause nothing

- D2: Request to Apply Low-speed Start/stop Control to Motor Drive

This request operates PWM control to low-speed drive when the motor starts or stops. But if the Special Rotation data (command value) is requested, the IC operates as D2 = 0 even if D2 = 1.	1	Specify PWM control
	0	No PWM control

- D3: Toggle PWM Torque Control Time Either 500 or 250 ms

If the output PWM control request in D2 is set to 1, this request can toggle the PWM torque control time between 500 and 250 ms.	1	Set to 500 ms
	0	Set to 250 ms

- D4, D5: Specify the Maximum PWM Duty Ratio

This request specifies the maximum PWM duty ratio for driving the motor. It also can be used when the Special Rotation data (command value) is requested.	D4	D5	Maximum PWM duty ratio
	0	0	16/16 (PWM OFF)
	1	0	11/16
	0	1	7/16
	1	1	4/16

- D6: Request to Stop the Motor in Emergency

This request stops the motor in emergency. This is adaptable to stop the motor when Special Rotation data (command value) is requested.	1	Request to stop the motor in emergency
	0	Normal

To restart the motor after stopping it in emergency, it needs to receive a different rotation data or a Request of motor recovery operation described below. If the slave receives a motor recovery request and a motor emergency stop request simultaneously, the motor emergency stop request takes precedence.

- D7: Request of Motor Recovery Operation

This request enables recovery when the motor stops at a different position from the specified rotation data.	1	Request motor recovery operation
	0	Normal

Even when the slave receives this request, the motor stops if the specified rotation data coincides with the current value, if a motor emergency stop request is received, or if any protective feature activates. A motor recovery request is also ignored if the over current detection flag is set.

*:Usually, the master should start the motor by updating the specified rotation data (command value).

7.4. Transmit Request Signal

If the slave receives a signal for its ID with ID4 = 0 and ID5 = 0, and without a parity error, it handles the signal as a transmission request signal. If it receives a signal that is not for its ID or if it receives its ID but a parity error occurs, it does not transmit the following signals of DATA1 Field, DATA2 Field and Checksum Field. (If a parity error occurs, the slave does not subsequently monitor a checksum error.)

The slave starts transmission in 0.5 to 2 Tbit after the end of the ID Field.

At initialization, the following data is cleared.

7.4.1. DATA1 Field

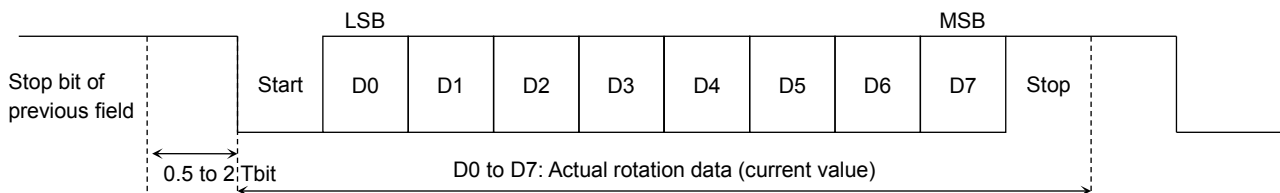
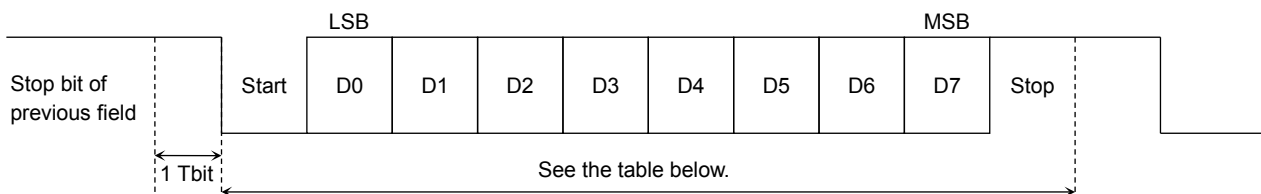

Figure 7.18 DATA1 Field

The actual rotation data, or the current value, is the data obtained with the AD converter by digitizing the potentiometer value. The slave transmits the actual rotation data obtained when a transmission request is accepted. Therefore, the data the master receives, could slightly differ from the actual rotation data due to the time differences.

7.4.2. DATA2 Field



D0	Over current detection flag (Detect motor current of approx. 1.5 A or higher)	D4	Received ID parity error flag
D1	Motor stopped flag (MT1 = Low, MT2 = Low)	D5	Over temperature detection flag
D2	CW (normal rotation: MT1 = High, MT2 = Low)	D6	Received checksum error flag
D3	CCW (reverse rotation: MT1 = Low, MT2 = High)	D7	Overvoltage detection flag (V _{CC} potential = 26 V or higher)

Figure 7.19 DATA2 Field

The D0 to D7 bits are cleared at initialization so that the motor stopped flag is not set even when the motor is still stopped.

Please refer to “7.4.4. Description of Transmit DATA2 Field and Related Operations” for details

7.4.3. Checksum Field

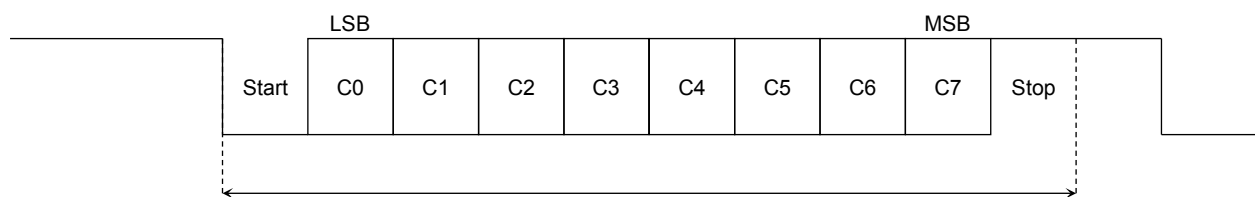

Figure 7.20 Checksum Field

Transmits the inversion of the Data (8Tbit) obtained by adding DATA1, DATA2, and a carry.

7.4.4. Description of Transmit DATA2 Field and Related Operations

- D0: Over current Detection Flag**
 When the current of 1.5A (typ.) or more flows to motor driver's high side or low side, the detection of the over current is detected approximately between 9 μ s-18 μ s.
 If over current is detected in the motor driver, it stops the motor (high-impedance) and sets the over current detection flag to 1. The flag remains set until a diagnosis flag clear request is received or the motor driver enters standby mode. Clearing the flag enables the motor driver to operate but it does not start operating until it receives a motor recovery request or a new command value other than that received last.
- D1: Motor Stopped Flag**
 Once the motor rotates and stops, the motor driver sets the motor stopped flag to 1. The flag is cleared to 0 when the motor is rotating. It is cleared to 0 at initialization.
 Note: The data in D1, D2, and D3 is cleared to 0 when the IC is reset so that the master can know when a node has been reset.
- D2: CW (normal rotation) Flag**
 When motor output MT1 becomes High and MT2 becomes Low, the motor driver sets the CW flag to 1. When MT1 becomes Low, it clears the CW flag to 0.
- D3: CCW (reverse rotation) flag**
 When motor output MT2 becomes High and MT1 becomes Low, the motor driver sets the CCW flag to 1. When MT2 becomes Low, it clears the CCW flag to 0.
- D4: Received ID Parity Error Flag**
 If the motor driver detects an ID parity error or an invalid start or stop bit, it sets the received ID parity error flag to 1, which is maintained until it receives a communication error flag clear request or enters standby mode. If the start or stop bit is invalid, the received checksum error flag (D6) is also set to 1.
- D5: Over temperature Detection Flag**
 The over temperature detection circuit will detect when chip temperature exceeds 170°C(typ.) and will release when temperature is back to 150°C (typ.). The detection and the release delay is approximately 9 μ s-18 μ s.
 If the over temperature detection circuit detects an abnormal temperature within the IC chip, the motor driver and communication driver are stopped (high-impedance) and the over temperature detection flag is set to 1. The flag remains set until the diagnosis flag clear request is received or the motor driver enters standby mode. The drivers are re-enabled when the over temperature detection is released but the operation is not started until the slave receives a motor recovery request or a new command value other than that received last.

Note: The junction temperature of IC is 150°C max. If the IC is used or preserved under the over temperature, it does not guarantee the normal operation, and also it may cause smoking and ignition. Be sure not to exceed the temperature in any case. The IC has the over

Temperature detection function but it does not intend to limit the IC temperature under 150°C and as it does not guarantee the operation, it regards as an additional function.

Note: The over temperature detection circuit may detect an abnormal temperature when the IC temperature is increased, due to repeat CW/CCW of the motor in a short time period, or lock the motor.

- D6: Received Checksum Error Flag

If the motor driver detects a checksum error or an invalid start or stop bit, it sets the received checksum error flag to 1, which is maintained until it receives a communication error flag clear request or enters standby mode. If the start or stop bit is invalid, the received ID parity error flag (D4) is also set to 1.

- D7: Overvoltage Detection Flag

The IC has an over voltage detection circuit which will detect within approximately 9μs-18μs when 26V (typ.) is exceeded and will release within approximately 9μs-18μs after operating voltage returns to 26V (typ.) and below.

If the over voltage detection circuit detects an excessively high V_{CC} voltage, the motor driver stops the motor (high-impedance) and sets the overvoltage detection flag to 1. The flag remains set until a diagnosis flag clear request is received or the motor driver enters standby mode. The driver is re-enabled when the voltage falls to a normal value but it does not start operating until it receives a motor recovery request or a new command value other than that received last.

Note: The overvoltage detection circuit does not clamp the power supply potential. The application requires a protective feature at external IC to prevent V_{CC} from exceeding 40V.

7.5. Motor Driver Settings 1 (without PWM control when starting the motor and before stopping the motor)

When the output PWM control request (D2) in the received DATA2 field is set to 0, the PWM torque control time (D3 in DATA2 field) and maximum PWM duty ratio (D4, D5 in DATA2 field) specified as shown in the following table:

Table 7.6 Motor Driver Settings 1

No.	D5	D4	D3	D2	Motor drive state	Remarks
1	0	0	*	0	100% drive	Control for gradually changing the PWM duty ratio from 0 to the maximum is not applied when the motor starts or before the motor stops.
2	0	1	*	0	11 / 16 PWM drive	
3	1	0	*	0	7 / 16 PWM drive	
4	1	1	*	0	4 / 16 PWM drive	

*:D3 is don't care.

7.5.1. PWM Drive

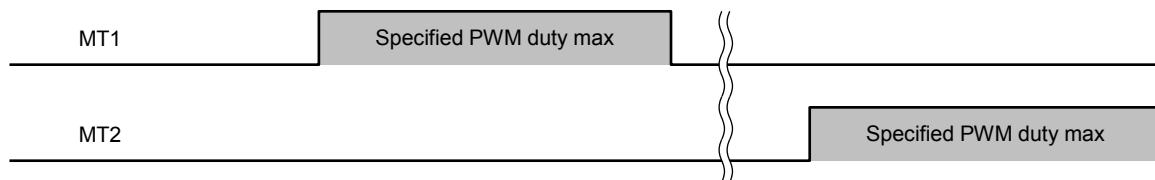

Figure 7.21 PWM Drive

7.5.2. PWM Control

PWM frequency: 19.2 kHz
 PWM duty: 16 steps (4 steps in each of 4 cycles)

7.5.3. PWM signal (image)

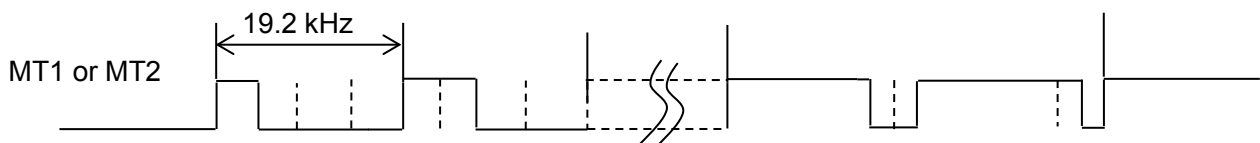

Figure 7.22 PWM signal

Please refer to “7.7 Description of PWM Duty Ratio” for details

7.6. Motor Drive Settings 2 (with PWM control when starting the motor and before stopping the motor)

When D2 in the received DATA2 field is set to 1, user can select the driver output by changing D3, D4 and D5 specified in the following table:

(D2: output PWM control request, D3: PWM torque control time, D4 & D5: maximum PWM duty ratio)

Table 7.7 Motor Drive Settings 2

No.	D5	D4	D3	D2	Motor Drive State
5	0	0	0	1	The duty ratio changes from 0 to the specified maximum according to the PWM duty mapping data when starting the motor or before stopping the motor. When starting the motor, the PWM duty ratio changes at the rate of approximately 15.625 ms per single interval of the startup control timer count. Before stopping the motor, the value of command value - current value is used as the PWM duty ratio.
6	0	1	0	1	
7	1	0	0	1	
8	1	1	0	1	
9	0	0	1	1	The duty ratio changes from 0 to the specified maximum according to the PWM duty mapping data when starting the motor or before stopping the motor. When starting the motor, the PWM duty ratio changes at the rate of approximately 31.25 ms per single interval of the startup control timer count. Before stopping the motor, the value of command value - current value is used as the PWM duty ratio.
10	0	1	1	1	
11	1	0	1	1	
12	1	1	1	1	

7.6.1. Example PWM Drive (image)

For the details about PWM duty and PWM duty mapping data, please refer to “7.7 Description of PWM Duty Ratio”

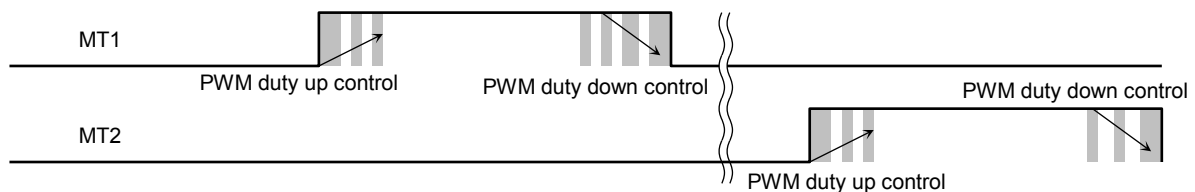

Figure 7.23 Example PWM Drive

7.6.2. Description of PWM Duty Ratio Control

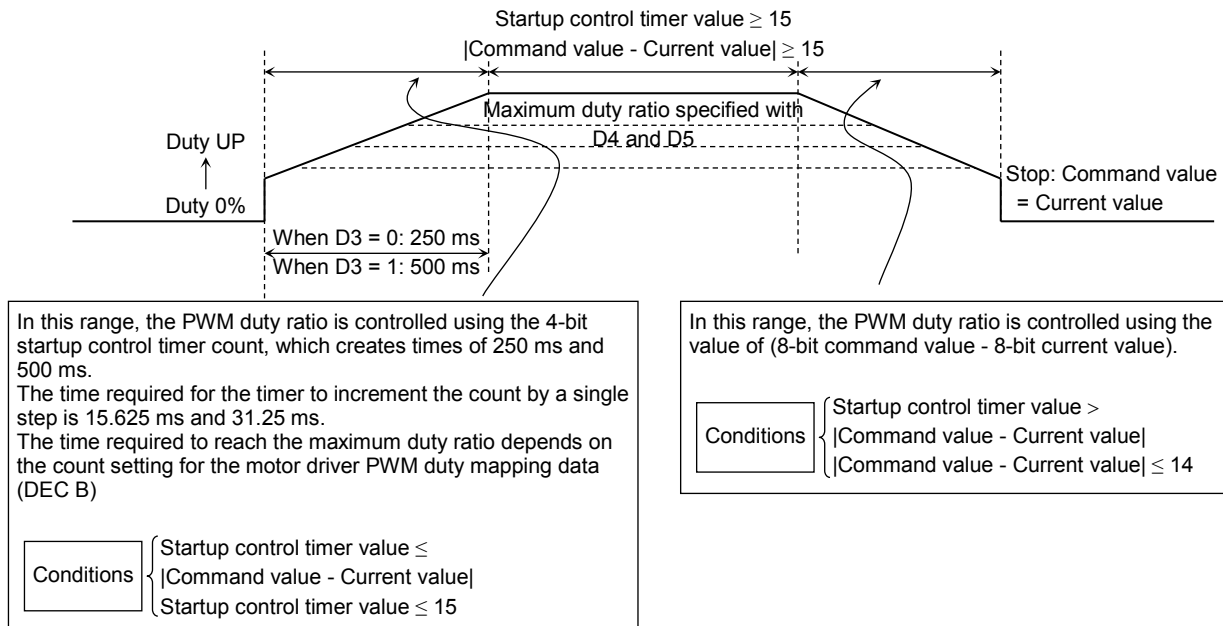

Figure 7.24 PWM Duty Ratio Control

7.7. Description of PWM Duty Ratio

7.7.1. Motor Driver PWM duty Mapping Data (DEC B)

Table 7.8 PWM duty Mapping Data

Command value - Current value of both startup control timer count value and before stopping the motor	PWM duty setting Data			
	D4 = 0 D5 = 0	D4 = 1 D5 = 0	D4 = 0 D5 = 1	D4 = 1 D5 = 1
0h	2h	2h	2h	2h
1h	3h	3h	3h	3h
2h	4h	4h	4h	3h
3h	5h	5h	5h	3h
4h	6h	6h	6h	3h
5h	7h	7h	6h	3h
6h	8h	8h	6h	3h
7h	9h	9h	6h	3h
8h	Ah	Ah	6h	3h
9h	Bh	Ah	6h	3h
Ah	Ch	Ah	6h	3h
Bh	Dh	Ah	6h	3h
Ch	Eh	Ah	6h	3h
Dh	Eh	Ah	6h	3h
Eh	Fh	Ah	6h	3h
Fh	Fh	Ah	6h	3h

7.7.2. Duty Ratio Calculation Formula

$$\text{Duty (\%)} = 100 \times (\text{Output PWM data} + 1) / 16$$

- When output PWM control request (D3) in reception DATA2 field = 0:
 $15.625 \text{ ms} \times (\text{Startup control timer count value} + 1)$
 Time required to reach 100% PWM duty ratio: $15.625 \text{ ms} \times 14 = 218 \text{ ms}$
- When output PWM control request (D3) in reception DATA2 field = 1:
 $31.25 \text{ ms} \times (\text{Startup control timer count value} + 1)$
 Time required to reach 100% PWM duty ratio: $31.25 \text{ ms} \times 14 = 437 \text{ ms}$

7.7.3. PWM Duty detailed

PWM wave form correspond to the PWM Duty setting data

■ : output high-impedance

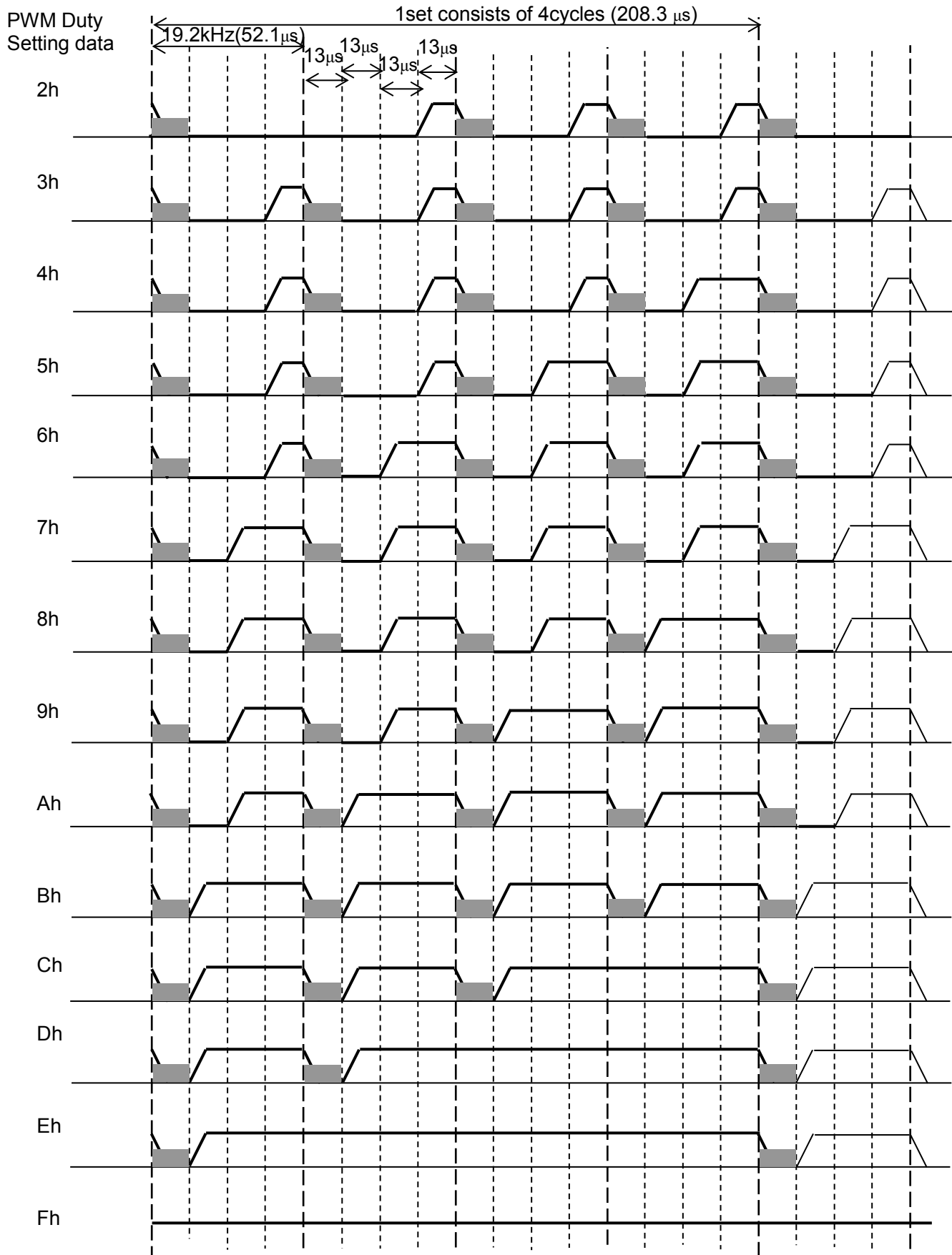

Figure 7.25 PWM Duty detailed

7.7.4. Supplementary Information on PWM Waveforms

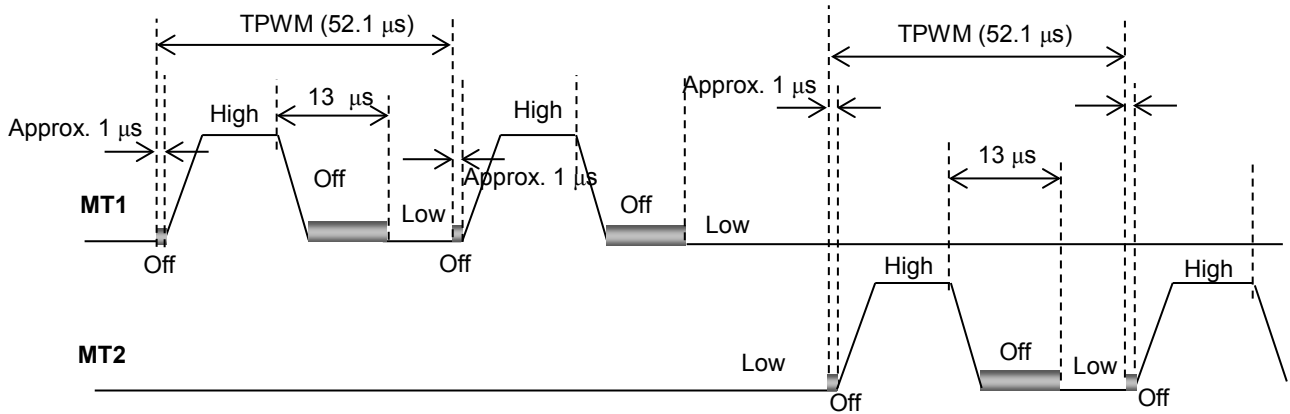

Figure 7.26 PWM Waveforms

7.7.5. Example of Motor Driver Operation Timing for urgent CW/CCW rotation (when PWM = 100%)

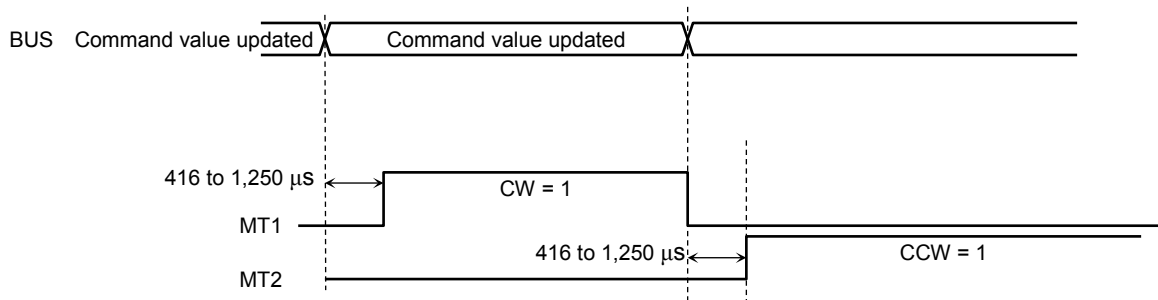

Figure 7.27 Example Motor Driver Operation Timing

Driving starts approximately 416 to 1,250 μ s after the command value is received.

7.7.6. PWM Operation when a Command Value is specified to be the Current Value + 1

- Case: The motor rotates with the minimum PWM duty ratio.

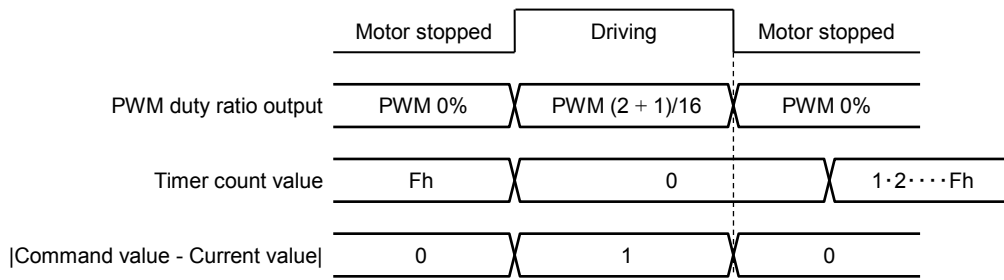

Figure 7.28 PWM Operation 1

- Start the motor under the condition of (command value - current value) = 1.
 - When the startup control timer value = 0, compare it with the data of (command value - current value) = 1 and generate PWM duty ratio data according to the startup control timer value.
 - The motor starts rotating and (command value - current value) becomes 0 so that motor drive is stopped without proceeding to control that is applied before the motor stops. (The PWM duty ratio when (command value - current value) = 0 is defined to be 2h but stopping the motor takes precedence.)
 - To proceed to control that is applied before the motor stops, both of the following conditions must be satisfied:
Startup control timer value > |Command value - Current value|
|Command value - Current value| ≥ 1
- Case: The motor does not rotate with the minimum PWM duty ratio but rotates with the next increased PWM duty ratio

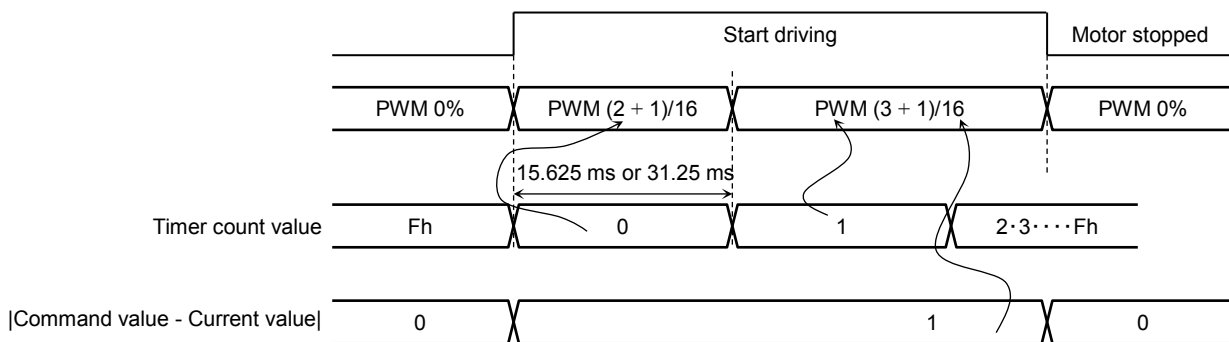

Figure 7.29 PWM Operation 2

- If driving the motor does not cause it to rotate, the startup control timer value increases from 0 to 1 and output the PWM duty ratio of $(3 + 1) / 16$. If the new value causes the motor to rotate, (command value - current value) becomes 0 and the motor would be stopped. If the motor does not rotate with a PWM duty ratio of $(3 + 1) / 16$, the startup control timer value increases from 1 to 2 so that the condition of Startup control timer value > |Command value - Current value| is satisfied, resulting in a transition to control that is applied before the motor stops. This transition does not change the PWM duty ratio.
- The above example shows the case when the motor rotates and then (command value - current value) becomes 0. However, please note that if the motor does not rotate, driving continues with a PWM duty ratio of $(3 + 1) / 16$.

7.7.7. Example of Potentiometer Voltage Detection After Wake-up

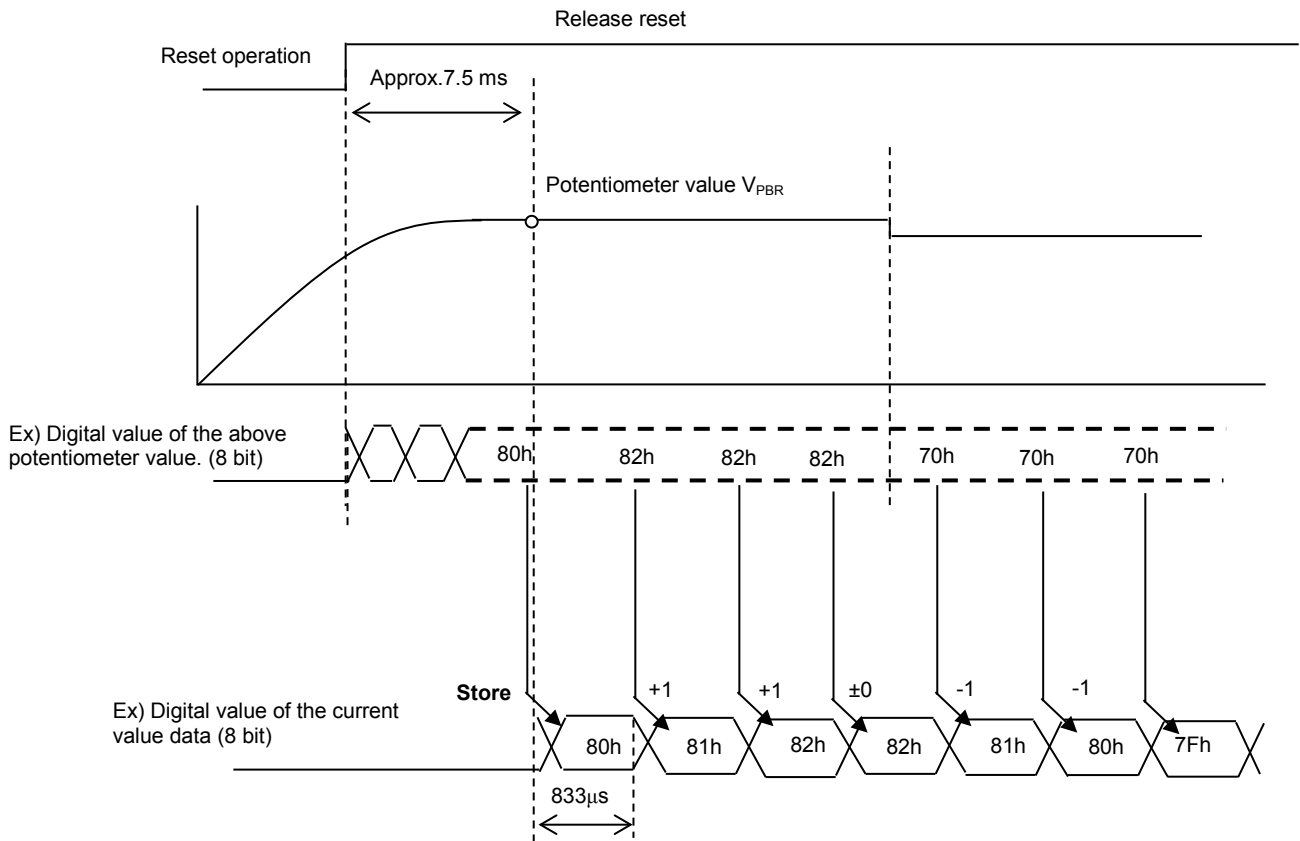

Figure 7.30 Example of Potentiometer Voltage Detection After Wake-up

After releasing the reset, the voltage value of potentiometer (voltage value of V_{PBR} pin) would be converted by AD converter and fetched into the IC.

After the wake-up (after releasing the reset), V_{PBR} value is decided as the current value within approximately 7.5ms (when oscillates with 4MHz). Before that, the current value is 00h.

After decide the current value from V_{PBR} , AD converter converts the 1LSB of data variation in V_{PBR} value during approximately 833µs, and the current value follows the V_{PBR} to make it equals to each other.

(The clock from the adjusted normal baud rate is used, but there may be maximum 15% of error during the time between after the wake-up and before the first reception)

8. Absolute Maximum Ratings

Table 8.1 Absolute Maximum Ratings

 (T_a = 25°C unless otherwise specified)

Characteristics	Symbol	Applicable Pins	Conditions	Rating	Unit
Supply voltage	V _{CC}	V _{CC}	-	-0.3 to 40	V
	V _{DD}	V _{DD}	Logic power supply	-0.3 to 6	
Protective diode current	I _{diode}	ID0, ID1, ID2, ID3, SEL0, SEL1, V _{PBR} TE, T0, T1, T2	-	±10	mA
Output current	I _{OUT}	MT1, MT2	If short-circuited to V _{CC} or ground (within 50 ms)	±2.0	A
		V _{REG}	-	-20	mA
Input/output voltage	V _{IN} V _{OUT}	MT1, MT2	V _{OUT} ≤ 40V	-0.3 to V _{CC} + 0.3	V
		ID0, ID1, ID2, ID3, SEL0, SEL1, V _{PBR} TE, T0, T1, T2	V _{IN} ≤ 6V	-0.3 to V _{DD} + 0.3	
		BUS	-	GND + 30, V _{CC} - 30	
			V _{CC} = GND = 0 V	±30	
Storage temperature	T _{stg}	-	-	-55 to 150	°C
Junction temperature (Max)	T _j	-	-	150	

Note: the range of V_{DD} is defined as the power range of CMOS.

The absolute maximum ratings of a semiconductor device are a set of specified parameter values which must not be exceeded during operation, even for an instant. Exposure to conditions beyond those listed above may cause permanent damage to the device or affect device reliability, which could increase potential risks of personal injury due to IC blowup and/or burning. The equipment manufacturer should design so that no maximum rating value is exceeded. Make it sure to the parameter values remain within these specified ranges during device operation.

8.1. Thermal Characteristics

Table 8.2 Thermal Characteristics

Characteristics	Symbol	Rating	Conditions	Unit
Power dissipation	P_D	1.32	1layer, 76.2 × 114.3 × 1.6mm, Cu coverage:30%, thickness:35μm, $T_a = 25^\circ\text{C}$	W
Thermal resistance	$R_{\theta j-a}$	160	IC alone	$^\circ\text{C} / \text{W}$
	$R_{\theta j-a}$	95	1layer, 76.2 × 114.3 × 1.6 mm, Cu coverage:30%, thickness:35μm	$^\circ\text{C} / \text{W}$
	$R_{\theta j-a}$	60	4layer, 76.2 × 114.3 × 1.6 mm, Cu coverage:30%, thickness:35μm	$^\circ\text{C} / \text{W}$

Note: Package (SSOP24-P-300-0.65A)

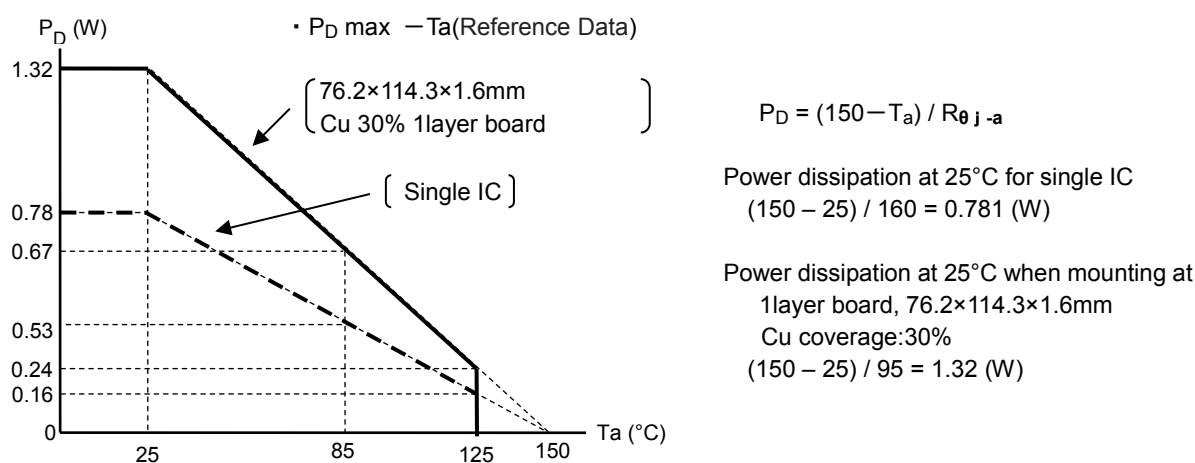

Figure 8.1 Thermal Characteristics

9. Operating Ranges

Table 9.1 Operating Ranges

Characteristics	Symbol	Rating	Unit	Remarks
Supply voltage	V _{CC}	7 to 18	V	-
	V _{DD}	4 to 5.5		MOS logic operating range
Operating temperature	T _{opr}	-40 to 125	°C	

10. Electrical Characteristics

10.1. General IC Characteristics

Table 10.1 General IC Characteristics

(V_{CC} = 7 to 18 V, T_a = -40 to 125°C and No load at motor driver output unless otherwise specified)

Characteristics	Symbol	Applicable Pins	Test Conditions	Min	Typ.	Max	Unit
Current consumption (V _{CC})	I _{CC}	V _{CC}	ID0~ID3=0, SEL0, SEL1 = 0&1 BUS = 0	-	-	6	mA
Current consumption (V _{DD})	I _{DD}	V _{DD}	V _{DD} = 5 V, IN = open	-	0.5	3	
Standby current	I _{stby}	V _{CC}	BUS = V _{CC} in Standby mode	-	-	10	μA
“L” level input current	I _{IL1}	TE, T0, T1, T2	V _{DD} = 5 V V _{IN} = 0 V	-10	-	10	μA
	I _{IL2}	ID0, ID1, ID2 ID3, SEL0, SEL1		-200	-100	-50	
“H” level input current	I _{IH1}	TE, T0, T1, T2	V _{DD} = 5 V V _{IN} = 5 V	50	100	200	
	I _{IH2}	ID0, ID1, ID2 ID3, SEL0, SEL1		-10	-	10	
“L” level input voltage	V _{IL1}	TE T0, T1, T2	-	0	-	0.2 × V _{DD}	V
“H” level input voltage	V _{IH1}	ID0, ID1 ID2, ID3 SEL0, SEL1	-	0.8 × V _{DD}	-	1.0 × V _{DD}	
Schmitt hysteresis width	V _{IHYS1}		-	-	0.5	-	

10.2. 5 V Power Supply

Table 10.2 5 V Power Supply Characteristics

($V_{CC} = 7$ to 18 V, $T_a = -40$ to 125°C and No load at motor driver output unless otherwise specified)

Characteristics	Symbol	Applicable Pins	Test Conditions	Min	Typ.	Max	Unit
5 V supply output voltage	V_{REG}	V_{REG}	operating state	4.5	4.9	5.5	V
5 V supply variation with load	ΔV_{REG}		$V_{CC} = 7.3$ to 18 V Difference between supply voltages when the load current is 0 mA and -3 mA	-0.2	-	0	
Reset termination voltage	V_{RSTP}		-	3.4	3.7	4	
Reset voltage for low voltage detection	V_{RSTM}		-	3	3.3	3.6	
Reset hysteresis width	V_{RSTH}		-	-	0.4	-	

10.3. Oscillator Circuit

Table 10.3 Oscillator Block Characteristics

($V_{CC} = 7$ to 18 V, $T_a = -40$ to 125°C and No load at motor driver output unless otherwise specified)

Characteristics	Symbol	Applicable Pins	Test Conditions	Min	Typ.	Max	Unit
Oscillation frequency	f_{osc}	Internal signals	Based on 4 MHz	-15	-	+15	%

The above item cannot be directly monitored (tested).

10.4. A/D Circuit

Table 10.4 A/D Block Characteristics

($V_{CC} = 7$ to 18 V, $T_a = -40$ to 125°C and No load at motor driver output unless otherwise specified)

Characteristics	Symbol	Applicable Pins	Test Conditions	Min	Typ.	Max	Unit
Input detection voltage range	V_{ADIN}	V_{PBR}	-	0	-	V_{REG}	V
Input current	I_{VPBRH}		$V_{IN} = V_{REG}$	-1	-	1	μA
	I_{VPBRL}		$V_{IN} = 0\text{V}$	-5	-	0	μA
Input conversion error	ERRbit		Compared to theoretical value	-1.1	-	+1.1	LSB
Conversion time	-		-	-	-	833	-

10.5. Motor Driver

Table 10.5 Motor Driver Characteristics

($V_{CC} = 7$ to 18 V and $T_a = -40$ to 125°C unless otherwise specified)

Characteristics	Symbol	Applicable Pins	Test Conditions	Min	Typ.	Max	Unit
Output voltage	V_{OH}	MT1, MT2	$V_{CC}: 12$ V, Output "H" $I_{OUT} = -0.2$ A	11.6	11.8	12	V
	V_{OL}		$V_{CC}: 12$ V, Output "L" $I_{OUT} = 0.2$ A	0	-	0.5	
High output ON resistance	R_{HON}		$I_{OUT} = -0.2$ A, $T_a = 25^\circ\text{C}$	-	1	-	Ω
			$I_{OUT} = -0.2$ A, $T_a = 125^\circ\text{C}$	-	1.2	2.0	
			$I_{OUT} = -0.2$ A, $T_a = -40^\circ\text{C}$	0.4	0.8	-	
Low output ON resistance	R_{LON}		$I_{OUT} = 0.2$ A, $T_a = 25^\circ\text{C}$	-	1.2	-	
			$I_{OUT} = 0.2$ A, $T_a = 125^\circ\text{C}$	-	1.5	2.5	
			$I_{OUT} = 0.2$ A, $T_a = -40^\circ\text{C}$	0.5	1	-	
Output OFF leakage current	I_{LO}		Output OFF state, $V_{OUT} = 0$ V	-10	-	10	μA
			Output OFF state, $V_{OUT} = V_{CC}$				
Short-circuit detection current. To ground	I_{SLMAX}	-	-2	-1.5	-1	A	
Short-circuit detection current. To VCC	I_{SHMAX}	-	1	1.5	2		
Over voltage detection	V_{SDH}	V_{CC}	No load at motor driver	24.5	26	27.5	V
Over temperature detection	T_{SDH}		Guaranteed by design value. Cannot be guaranteed by testing.	150	170	-	$^\circ\text{C}$
Over temperature detection reset	T_{SDHYS}			130	150	-	

10.6. LIN Receiver

Table 10.6 LIN Receiver Characteristics

(VCC = 7 to 18 V, Ta = -40 to 125°C and No load at motor driver output unless otherwise specified)

Characteristics	Symbol	Applicable Pins	Test Conditions	Min	Typ.	Max	Unit
BUS current	I _{IHRX}	BUS	-	-10	-	10	μA
	I _{ILRX}		V _{CC} = 12 V, V _{IN} = 0 V	-600	-	-255	
	I _{BUSPASR-EC}		Driver OFF, V _{CC} = 7.3 to 18V V _{BUS} = 8 to 18V V _{BUS} > V _{CC}	-	-	20	
	I _{BUS}		V _{CC} = 0 V, V _{BUS} = 0 to 18 V	-	-	100	
	I _{BUS-NOGND}		GND pin connected to V _{CC} V _{BUS} = 8 to 18 V, V _{CC} = 12 V	-1	-	1	mA
Standby release voltage	V _{BUSSTB}		-	V _{CC} -5.5	-	V _{CC} -1.0	V
Input detection voltage	V _{IHRX}		-	0.4V _{CC}	0.5V _{CC}	0.6V _{CC}	V
	V _{ILRX}		-	0.4V _{CC}	0.5V _{CC}	0.6V _{CC}	
Input detection hysteresis width	V _{HYS}		-	-	-	0.175V _{CC}	
Dominant voltage range	V _{DOM}		-	-8	-	0.4V _{CC}	
Recessive voltage range	V _{REC}		-	0.6V _{CC}	-	18	
Output delay symmetry	T _{RTF}		Trecpdf-Trecpdr	-2	-	2	μs
Response delay	T _{TRXPD}		-	-	-	6	

*LINBUS contains a pull-up resistor of 30 kΩ (typ.) as a slave resistor.

10.7. LIN Driver

Table 10.7 LIN Driver Characteristics

(VCC = 7 to 18 V, Ta = -40 to 125°C and No load at motor driver output unless otherwise specified)

Characteristics	Symbol	Applicable Pins	Test Conditions	Min	Typ.	Max	Unit		
Output current	I _{OLIN}	BUS	TXL = 0 V, V _{OUT} = 0.4V _{CC}	40	100	200	mA		
Output voltage change rate	V _{TR/S}		Refer to AC characteristic.	V _{CC} = 18 V	1	2.2	3	V/μs	
	V _{TF/S}			V _{CC} = 7.3 V	0.5	-	3		
Output delay	T _{TXPDF}			-	-	1	4	μs	
	T _{TXPDR}			V _{CC} = 18 V	-5	-	5		
Waveform rising and falling time	T _{SYS}			V _{CC} = 7.3 V	-4	-	4		
				-	3.5	-	22.5		
	T _{SLOPE}			T _{recpdf-T_{recpdr}}	-2	-	2		
Output delay symmetry	T _{RTF}								
Low output voltage	V _{OLBUS}			V _{CC} = 7.3 V, LOAD = 500 Ω	-	1.0	1.4		V
				V _{CC} = 18 V, LOAD = 500 Ω	-	1.8	2.0		
				V _{CC} = 7.3 V, LOAD = 1 kΩ	0.4	0.8	-		
				V _{CC} = 18 V, LOAD = 1 kΩ	0.8	1.2	-		
Output OFF leakage current	I _{TXOFF1}			V _{OUT} = V _{CC}	-	-	10	μA	
	I _{TXOFF2}	V _{CC} = 0 V, V _{OUT} = -12 V		-1	-0.6	-	mA		
Short-circuit detection current	I _{SHORT}	-	40	100	200	mA			
Over temperature detection temperature	T _{SDH}	Guaranteed by design value.	150	170	-	°C			
Over temperature release temperature	T _{SDL}	Cannot be guaranteed by testing.	130	150	-				

Note 1: If the chip temperature (T_j) exceeds 170°C(typ.), the over temperature detection circuit temporarily turns off the LIN driver output until getting down to 150°C(typ.).

Note 2: The IC contains a short-circuit current detection circuit but does not provide time for recovery.

Note 3: When measuring receiver input current, it includes output OFF leakage current.

Note 4: The above LIN driver characteristic is measured with external resistor of 22Ω in series at BUS.

- LIN Receiver (AC characteristic)

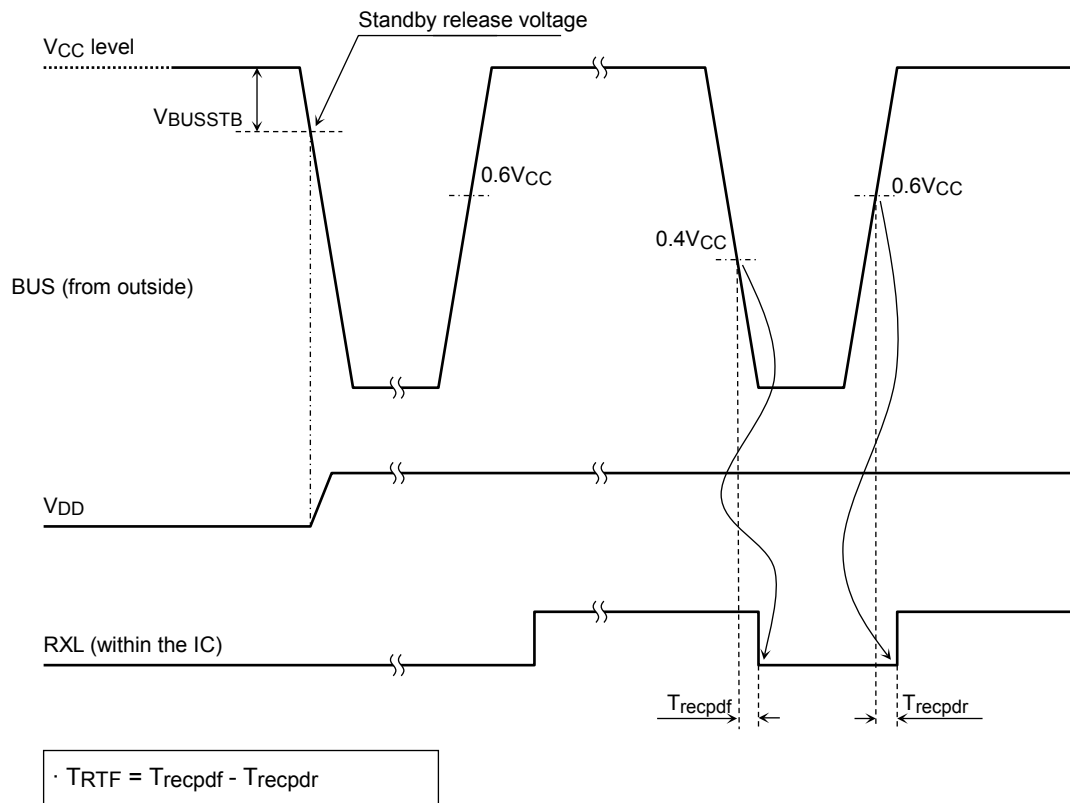

Figure 10.1 LIN Receiver Timing

- LIN Driver (AC characteristic)1

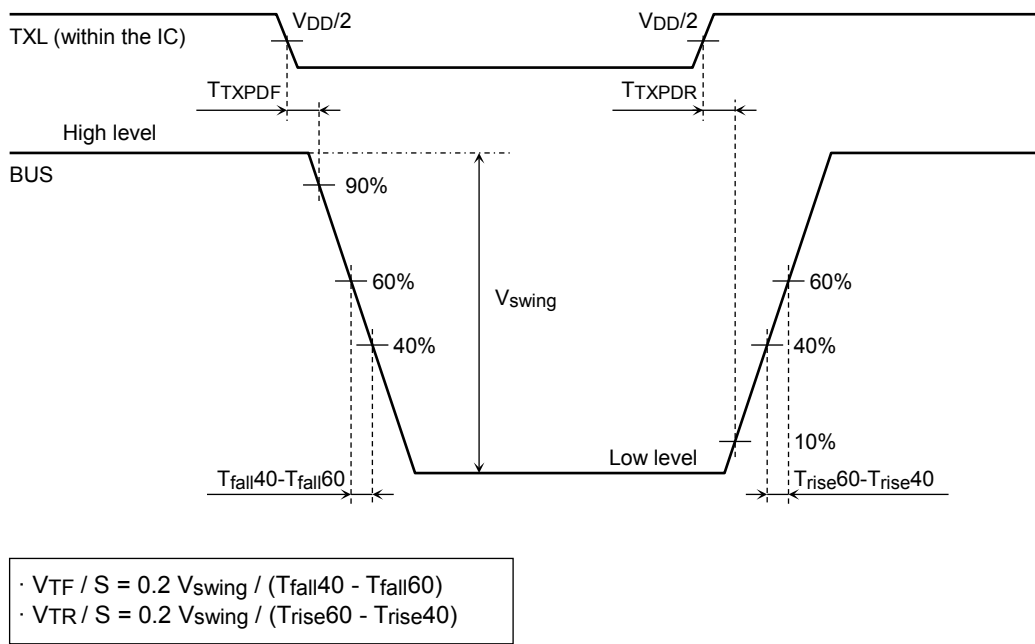

Figure 10.2 LIN Driver Timing1

- LIN Driver (AC characteristic)2

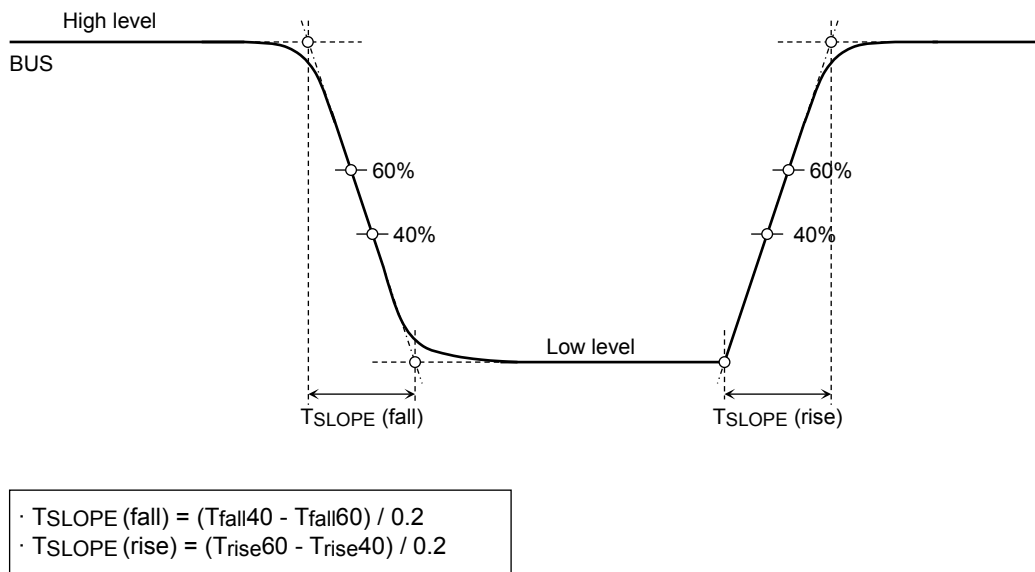

Figure 10.3 LIN Driver Timing2

11. Application Circuit Example

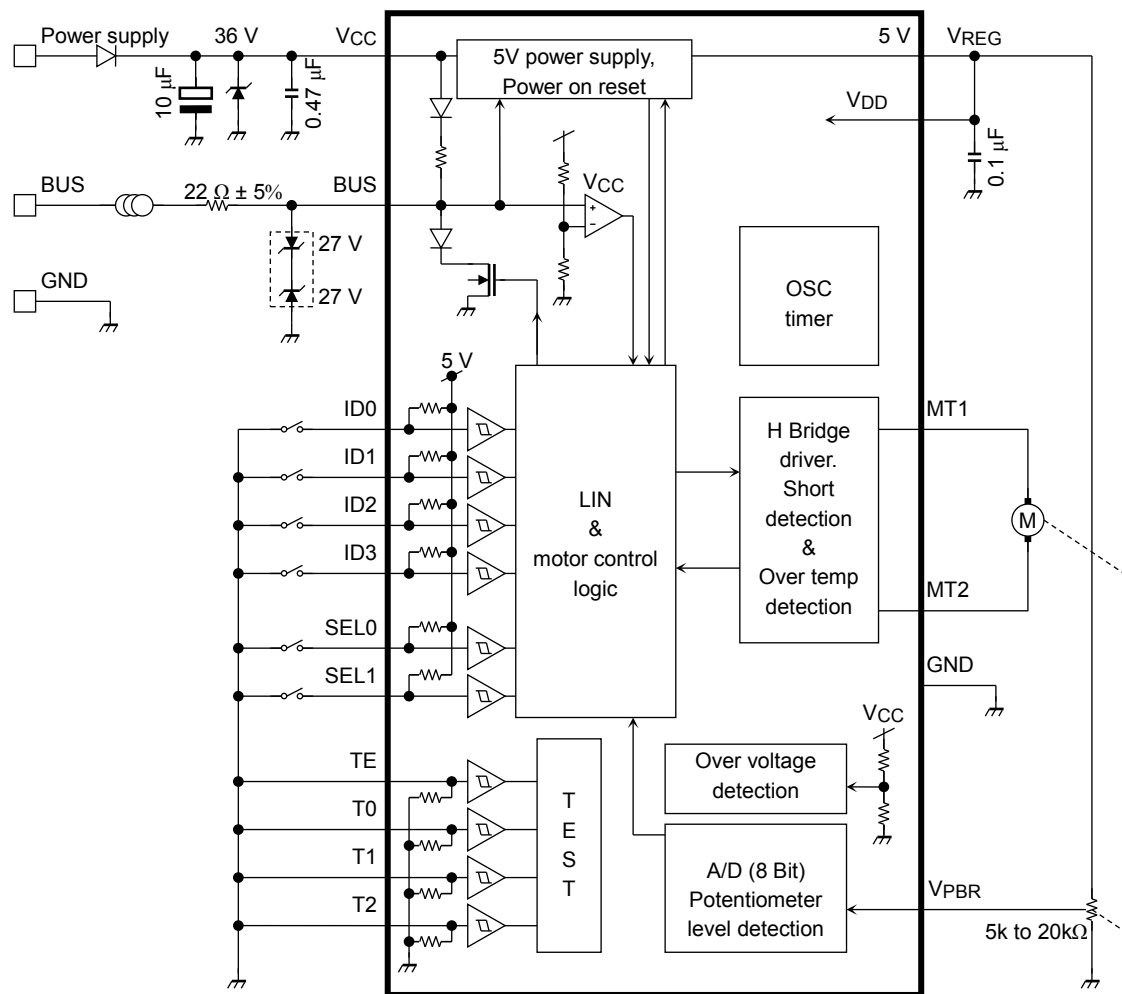

Figure 11.1 Application Circuit Example

Notes on Use

- The TB9056FNG does not have features that guard against reverse battery connection or over current on the VCC and VREG pins and does not detect when the VPBR pin is left open. In case the VPBR pin is left open, the pull-up resistor of MΩ make the current value FFh. But the current value may be changed by a leak current of µA or noises.
- 40 V or higher voltage at the Vcc pin may cause damage to the IC. Protection circuit is necessary in case that Vcc becomes more than 40V, due to the induced voltage of motor.
- If the Vcc voltage increases over 18V, the current consumption may be higher than specification, even in standby mode. And also it may cause wake-up.
- 27V Zener diode should be connected to BUS in order to protect the IC. For the case that GND is open, two Zener diodes should be used so that BUS line remains unaffected by GND voltage.

12. Package Information

- SSOP24-P-300-0.65A

Unit: mm

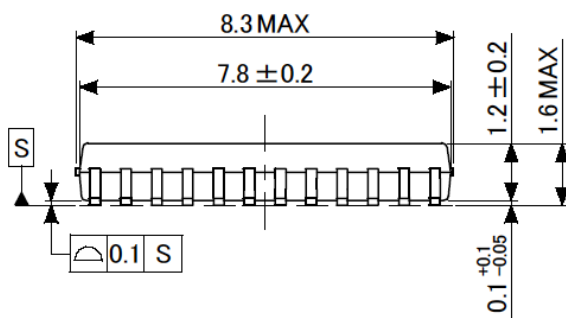
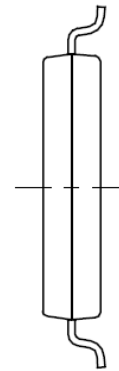
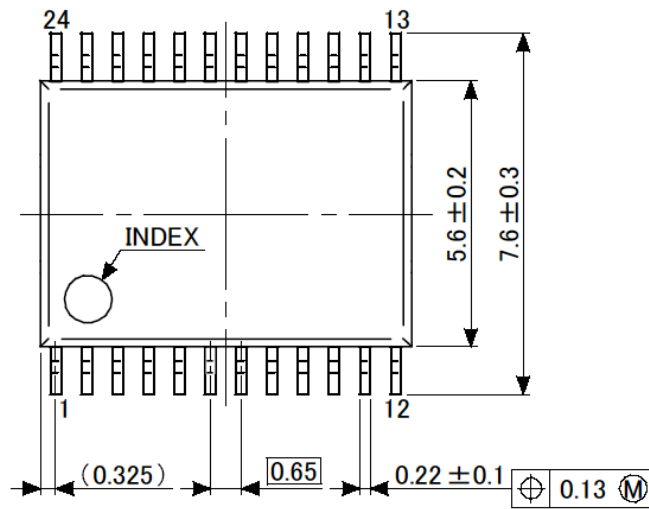

Lead edge dimension

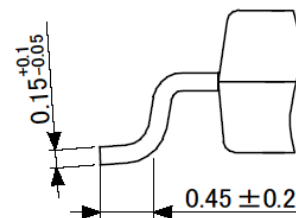

Figure 12.1 Package Dimensions

13. IC Usage Considerations

- (1) The block diagram used in this specification is for explaining functions and operations, and some of them may be omitted / simplified.
- (2) The equivalent circuit diagram used in this specification is for explaining functions and operations, and some of them may be omitted / simplified.
- (3) The timing chart used in this specification is for explaining functions and operations, and some of them may be omitted / simplified.
- (4) The maximum rating is a standard that must not be exceeded even in the moment. Exceeding the maximum rating may cause damage, deterioration or damage to the IC, which may cause damage other than IC. Please do not exceed maximum rating under any operating conditions.
When using, please use within the stated operating range.
- (5) Parts in application circuit examples do not guarantee that malfunction or failure of applied equipment will not occur.
When choosing parts, conduct application evaluation sufficiently, confirm that there is no problem and use it.
- (6) Please do not install it incorrectly. It may cause damage to the IC and damage to the equipment.

RESTRICTIONS ON PRODUCT USE

Toshiba Corporation and its subsidiaries and affiliates are collectively referred to as "TOSHIBA". Hardware, software and systems described in this document are collectively referred to as "Product".

- TOSHIBA reserves the right to make changes to the information in this document and related Product without notice.
- This document and any information herein may not be reproduced without prior written permission from TOSHIBA. Even with TOSHIBA's written permission, reproduction is permissible only if reproduction is without alteration/omission.
- Though TOSHIBA works continually to improve Product's quality and reliability, Product can malfunction or fail. Customers are responsible for complying with safety standards and for providing adequate designs and safeguards for their hardware, software and systems which minimize risk and avoid situations in which a malfunction or failure of Product could cause loss of human life, bodily injury or damage to property, including data loss or corruption. Before customers use the Product, create designs including the Product, or incorporate the Product into their own applications, customers must also refer to and comply with (a) the latest versions of all relevant TOSHIBA information, including without limitation, this document, the specifications, the data sheets and application notes for Product and the precautions and conditions set forth in the "TOSHIBA Semiconductor Reliability Handbook" and (b) the instructions for the application with which the Product will be used with or for. Customers are solely responsible for all aspects of their own product design or applications, including but not limited to (a) determining the appropriateness of the use of this Product in such design or applications; (b) evaluating and determining the applicability of any information contained in this document, or in charts, diagrams, programs, algorithms, sample application circuits, or any other referenced documents; and (c) validating all operating parameters for such designs and applications. **TOSHIBA ASSUMES NO LIABILITY FOR CUSTOMERS' PRODUCT DESIGN OR APPLICATIONS.**
- **PRODUCT IS NEITHER INTENDED NOR WARRANTED FOR USE IN EQUIPMENTS OR SYSTEMS THAT REQUIRE EXTRAORDINARILY HIGH LEVELS OF QUALITY AND/OR RELIABILITY, AND/OR A MALFUNCTION OR FAILURE OF WHICH MAY CAUSE LOSS OF HUMAN LIFE, BODILY INJURY, SERIOUS PROPERTY DAMAGE AND/OR SERIOUS PUBLIC IMPACT ("UNINTENDED USE").** Except for specific applications as expressly stated in this document, Unintended Use includes, without limitation, equipment used in nuclear facilities, equipment used in the aerospace industry, and lifesaving and/or life supporting medical equipment. **IF YOU USE PRODUCT FOR UNINTENDED USE, TOSHIBA ASSUMES NO LIABILITY FOR PRODUCT.** For details, please contact your TOSHIBA sales representative or contact us via our website.
- Do not disassemble, analyze, reverse-engineer, alter, modify, translate or copy Product, whether in whole or in part.
- Product shall not be used for or incorporated into any products or systems whose manufacture, use, or sale is prohibited under any applicable laws or regulations.
- The information contained herein is presented only as guidance for Product use. No responsibility is assumed by TOSHIBA for any infringement of patents or any other intellectual property rights of third parties that may result from the use of Product. No license to any intellectual property right is granted by this document, whether express or implied, by estoppel or otherwise.
- **ABSENT A WRITTEN SIGNED AGREEMENT, EXCEPT AS PROVIDED IN THE RELEVANT TERMS AND CONDITIONS OF SALE FOR PRODUCT, AND TO THE MAXIMUM EXTENT ALLOWABLE BY LAW, TOSHIBA (1) ASSUMES NO LIABILITY WHATSOEVER, INCLUDING WITHOUT LIMITATION, INDIRECT, CONSEQUENTIAL, SPECIAL, OR INCIDENTAL DAMAGES OR LOSS, INCLUDING WITHOUT LIMITATION, LOSS OF PROFITS, LOSS OF OPPORTUNITIES, BUSINESS INTERRUPTION AND LOSS OF DATA, AND (2) DISCLAIMS ANY AND ALL EXPRESS OR IMPLIED WARRANTIES AND CONDITIONS RELATED TO SALE, USE OF PRODUCT, OR INFORMATION, INCLUDING WARRANTIES OR CONDITIONS OF MERCHANTABILITY, FITNESS FOR A PARTICULAR PURPOSE, ACCURACY OF INFORMATION, OR NONINFRINGEMENT.**
- Do not use or otherwise make available Product or related software or technology for any military purposes, including without limitation, for the design, development, use, stockpiling or manufacturing of nuclear, chemical, or biological weapons or missile technology products (mass destruction weapons). Product and related software and technology may be controlled under the applicable export laws and regulations including, without limitation, the Japanese Foreign Exchange and Foreign Trade Law and the U.S. Export Administration Regulations. Export and re-export of Product or related software or technology are strictly prohibited except in compliance with all applicable export laws and regulations.
- Please contact your TOSHIBA sales representative for details as to environmental matters such as the RoHS compatibility of Product. Please use Product in compliance with all applicable laws and regulations that regulate the inclusion or use of controlled substances, including without limitation, the EU RoHS Directive. **TOSHIBA ASSUMES NO LIABILITY FOR DAMAGES OR LOSSES OCCURRING AS A RESULT OF NONCOMPLIANCE WITH APPLICABLE LAWS AND REGULATIONS.**

TOSHIBA ELECTRONIC DEVICES & STORAGE CORPORATION

<https://toshiba.semicon-storage.com/>