

## GaAs MMIC POSITIVE CONTROL TRANSFER SWITCH, DC\* - 8GHz

### Typical Applications

The HMC427ALP3E is ideal for:

- Test Instrumentation
- Fiber Optics & Broadband Telecom
- Basestation Infrastructure
- Microwave Radio & VSAT
- Military Radios, Radar, & ECM

### Features

- High Isolation: 40 ~ 45 dB thru 6 GHz
- Low Insertion Loss: 1.5 dB at 6 GHz
- Non-Reflective Design
- 3x3mm SMT Package

### Functional Diagram

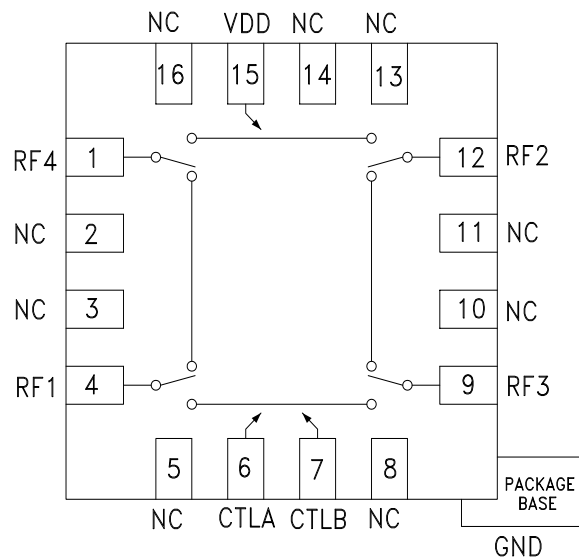

### General Description

The HMC427ALP3E is a low loss broadband positive control transfer switch in leadless surface mount package. Covering DC to 8 GHz, this switch offers high isolation and low insertion loss. The switch operates using a positive control voltage of 0/+5V and requires a fixed bias of +5V at < 20  $\mu$ A.

\* Blocking capacitors are required at ports RF1, 2, 3, & 4. Their value will determine the lowest transmission frequency.

### Electrical Specifications, $T_A = +25^\circ \text{C}$ , $V_{DD} = 5\text{V}$ , With 0/+5V Control, 50 Ohm System

Parameter	Frequency	Min.	Typ.	Max.	Units
Insertion Loss	DC - 6.0 GHz		1.5	2	dB
	DC - 8.0 GHz		1.8	2.1	dB
Isolation	DC - 1.0 GHz	45	50		dB
	DC - 2.0 GHz	40	45		dB
	DC - 6.0 GHz	36	43		dB
	DC - 8.0 GHz	35	43		dB
Return Loss	DC - 6.0 GHz		18		dB
	DC - 8.0 GHz		18		dB
Input Power for 1 dB Compression	1.0 - 8.0 GHz	25	26		dBm dBm
Input Third Order Intercept (Two-Tone Input Power= +12 dBm Each Tone, 1 MHz Tone Separation)	1.0 - 8.0 GHz	40	43		dBm dBm
Switching Characteristics	DC - 8.0 GHz	tRISE, tFALL (10/90% RF)	2		ns
		tON, tOFF (50% CTL to 10/90% RF)	10		ns

**GaAs MMIC POSITIVE CONTROL TRANSFER SWITCH, DC\* - 8GHz**

**Insertion Loss vs. Temperature**

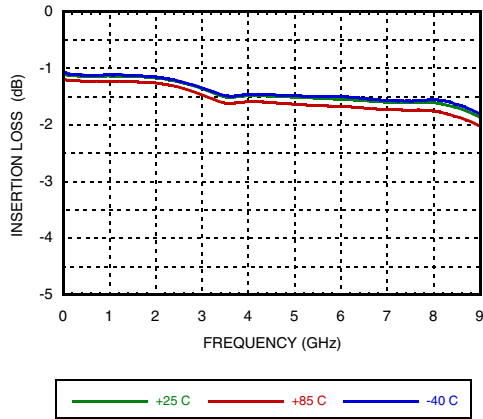

**Isolation**

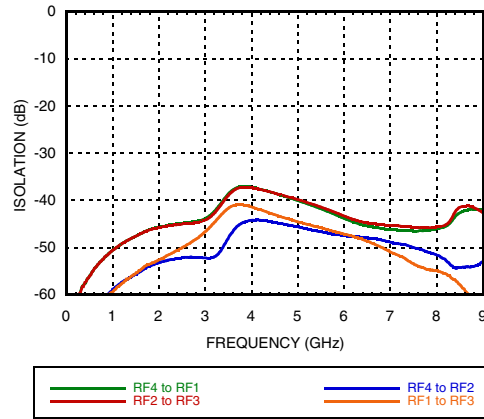

**Return Loss**

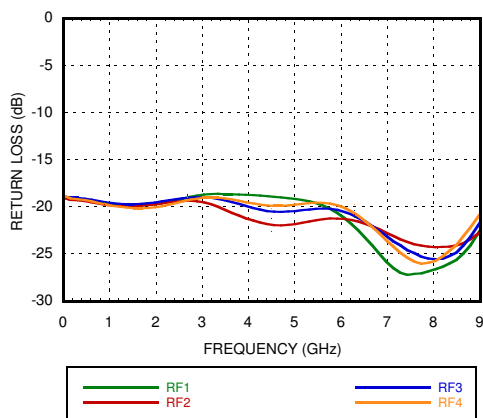

**0.1 and 1 dB Input Compression Point**

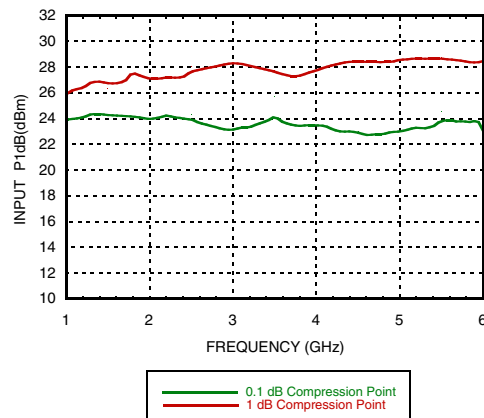

**Input Third Order Intercept Point**

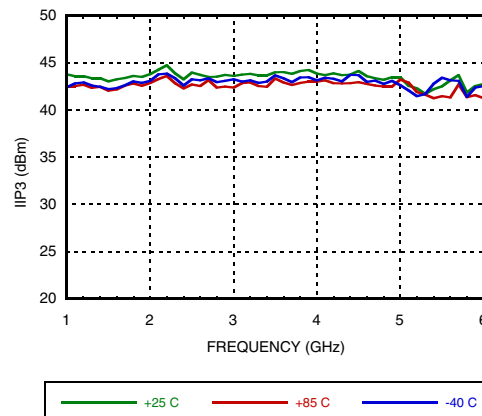

## GaAs MMIC POSITIVE CONTROL TRANSFER SWITCH, DC\* - 8GHz

### Absolute Maximum Ratings

Bias Voltage Range (VDD)	+7.0 VDC
Control Voltage Range (CTRLA & CTRLB)	-0.5V to VDD +1.0 VDC
Channel Temperature	150 °C
Thermal Resistance	130 °C/W
Storage Temperature	-65 to +150 °C
Operating Temperature	-40 to +85 °C
Maximum Input Power	+25.5 dBm (DC - 2 GHz)
	+27 dBm (2 GHz - 8 GHz)
ESD Sensitivity (HBM)	Class 1A
ESD Sensitivity (FICDM)	Class IV



**ELECTROSTATIC SENSITIVE DEVICE  
OBSERVE HANDLING PRECAUTIONS**

*Note:*

DC blocking capacitors are required at ports RF1, 2, 3, & 4. Their value will determine the lowest transmission frequency.

### Bias Voltage & Current

VDD Range = +5 VDC ± 10 %		
VDD (VDC)	IDD (Typ.) (µA)	IDD (Max.) (µA)
+5	5	10

### Control Voltages

State	Bias Condition
Low	0 to +0.2 VDC at < 1 µA Typical
High	Vdd ± 0.2 VDC at < 1 µA Typical

### Truth Table

Control Input		Signal Path State			
A	B	RF4 to RF2	RF1 to RF3	RF4 to RF1	RF2 to RF3
Low	High	On	On	Off	Off
High	Low	Off	Off	On	On

## GaAs MMIC POSITIVE CONTROL TRANSFER SWITCH, DC\* - 8GHz

### Outline Drawing

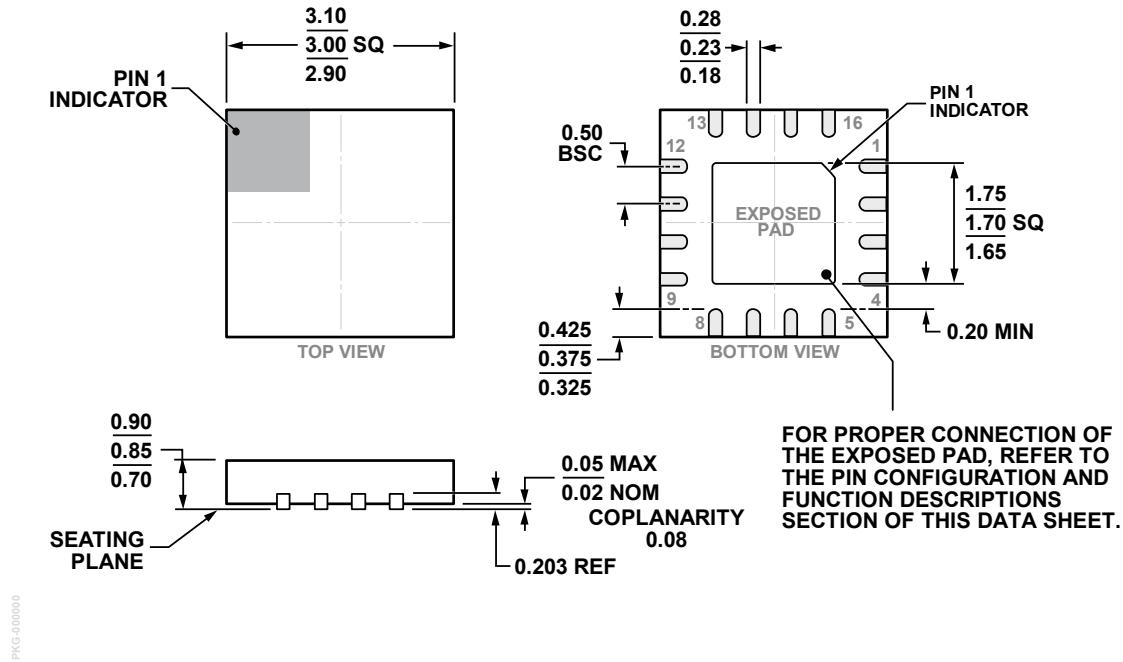

### Package Information

Part Number	Package Body Material	Lead Finish	MSL Rating	Package Marking <sup>[2]</sup>
HMC427ALP3E	RoHS-compliant Low Stress Injection Molded Plastic	100% matte Sn	MSL3 <sup>[1]</sup>	H427A XXXX

[1] Max peak reflow temperature of 260 °C

[2] 4-Digit lot number XXXX

## GaAs MMIC POSITIVE CONTROL TRANSFER SWITCH, DC\* - 8GHz

### Pin Descriptions

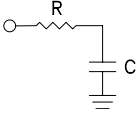
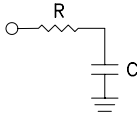
Pin Number	Function	Description	Interface Schematic
1, 4, 9, 12	RF4, RF1, RF3, RF2	This pin is DC coupled and matched to 50 Ohm. Blocking capacitors are required.	
2, 3, 5, 8, 10, 11, 13, 14, 16	NC	This pin should be connected to PCB RF ground to maximize isolation.	
	GND	Package bottom has exposed metal paddle that must be connected to PCB RF ground.	
6	CTRLA	See truth table and control voltage table.	
7	CTRLB	See truth table and control voltage table.	
15	VDD	Supply Voltage +5V ± 10%.	

## GaAs MMIC POSITIVE CONTROL TRANSFER SWITCH, DC\* - 8GHz

### Evaluation PCB

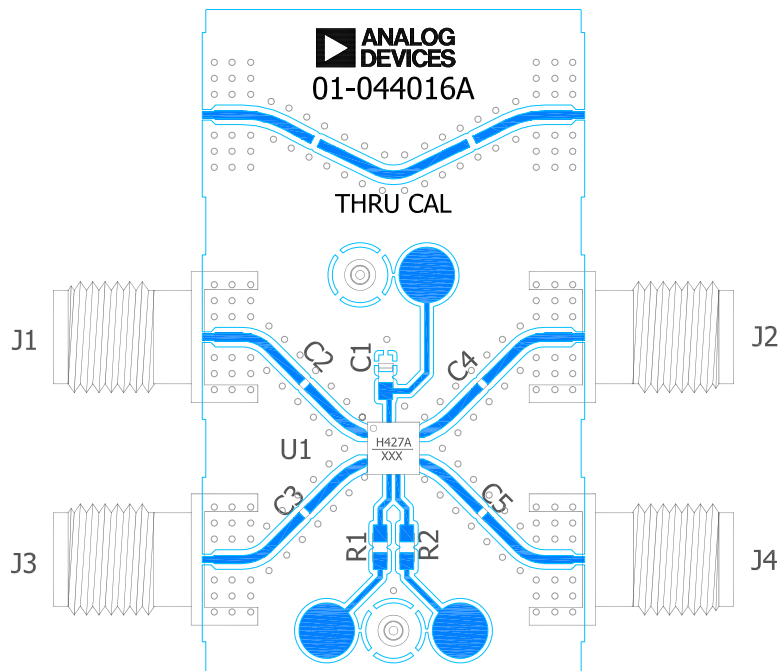

### List of Materials for Evaluation PCB EV1HMC427ALP3E <sup>[1]</sup>

Item	Description
J1 - J4	PCB Mount SMA RF Connector
J5 - J8	DC Pin
C1	1000 pF Capacitor, 0603 Pkg.
C2 - C5	100 pF Capacitor, 0402 Pkg.
R1 - R2	100 Ohm Resistor, 0603 Pkg.
U1	HMC427ALP3E Transfer Switch
PCB <sup>[2]</sup>	Evaluation PCB 01-044016A

[1] Reference this number when ordering complete evaluation PCB

[2] Circuit Board Material: Rogers 4350

The circuit board used in the final application should be generated with proper RF circuit design techniques. Signal lines at the RF port should have 50 ohm impedance and the package ground leads and package bottom should be connected directly to the ground plane similar to that shown above. The evaluation circuit board shown above is available from Analog Devices upon request.