

IEC Appliance Inlet C14 with Fuseholder 2-pole



IEC connector C14 with fuse holder 2-pole  
 Screw-on version from front or rear side  
 Solder/quick connect terminals  
 Screw-on mounting



IEC connector C14 with fuse holder 2-pole  
 Snap-in mounting from front side  
 Solder/quick connect terminals  
 Snap-in version



See below:  
[Approvals and Compliances](#)

**Description**

- Panel mount :  
 Screw-on version from front or rear side, snap-in version front side
- 2 Functions :  
 Appliance Inlet Protection class I , Fuseholder for fuse-links 5 x 20 mm 2-pole
- Meets the requirements of IEC 60335-1 for appliances in unattended use. This includes the enhanced requirements of glow wire tests acc. to IEC 60695-2-11 or -12 &-13.
- Solder / Quick Connect

**Characteristics**

- All single elements are already wired
- Plug removal necessary for fuse-link replacement
- Suitable for use in equipment according to IEC/UL 62368-1

**Other versions on request**

- Types for rivet mounting available upon request

**References**

- Alternative: version with line filter [5220](#)
- Alternative: Fuseholder 1-pole [6202](#)

**Weblinks**

[pdf data sheet](#), [html datasheet](#), [General Product Information](#), [Approvals](#), [Distributor-Stock-Check](#), [Accessories](#), [Detailed request for product](#)

**Technical Data**

Ratings IEC	10A / 250VAC; 50Hz	Appliance inlet/-outlet	C14 acc. to IEC 60320-1, UL 60320-1, CSA C22.2 no. 60320-1 (for cold conditions) pin-temperature 70 °C, 10A, Protection Class I
Ratings UL/CSA	10A / 250VAC; 60Hz	Fuseholder	2-pole, Shocksafe category PC2 acc. to IEC 60127-6, UL 498, for fuse-links 5 x 20mm
Dielectric Strength	> 2 kVAC between L-N > 2 kVAC between L/N-PE (1 min/50Hz)	Rated Power Acceptance @ Ta 23 °C	5 x 20: 1.6W 2-pole
Allowable Operation Temperature	-25 °C to 70 °C	Power Acceptance @ Ta > 23°C	Admissible power acceptance at higher ambient temperature see derating curves
IP-Protection	front side IP40 acc. to IEC 60529		
Protection against electric shock	Suitable for appliances with protection class I acc. to IEC 61140		
Terminal	Solder / Quick Connect , tin-plated		
Panel Thickness S	Screw: max 6 mm Mounting screw torque max 0.5Nm Snap-in: 1/1.5/2/2.5/3 mm		
Material: Housing	Thermoplastic, black, UL 94V-0		

**Approvals and Compliances**



Detailed information on product approvals, code requirements, usage instructions and detailed test conditions can be looked up in [Details about Approvals](#)

SCHURTER products are designed for use in industrial environments. They have approvals from independent testing bodies according to national and international standards. Products with specific characteristics and requirements such as required in the automotive sector according to IATF 16949, medical technology according to ISO 13485 or in the aerospace industry can be offered exclusively with customer-specific, individual agreements by SCHURTER.

## Approvals





The approval mark is used by the testing authorities to certify compliance with the safety requirements placed on electronic products.

Approval Reference Type: 6220

Approval Logo	Certificates	Certification Body	Description
	VDE Approvals	VDE	Certificate Number: 40046421
	UL Approvals	UL	UR File Number: E93617
	CCC Approvals	CCC	CCC Certificate Number: 2018180204006591



## Product standards

Product standards that are referenced

Organization	Design	Standard	Description
	Designed according to	IEC 60320-1	Appliance couplers for household and similar general purposes
	Designed according to	IEC 60127-6	Miniature fuses. Part 6. Fuse-holders for miniature fuse-links
	Designed according to	IEC 61058-1	Switches for appliances. Part 1. General requirements
	Designed according to	UL 60320-1	Standard for Attachment Plugs and Receptacles
	Designed according to	CSA C22.2 no. 60320-1	General Use Receptacles, Attachment Plugs, and Similar Wiring Devices







## Application standards

Application standards where the product can be used

Organization	Design	Standard	Description
	Designed for applications acc.	IEC/UL 62368-1	Audio/video, information and communication technology equipment - Part 1: Safety requirements
	Designed for applications acc.	IEC 60601-1	Medical electrical equipment - Part 1: General requirements for basic safety and essential performance
	Designed for applications acc.	IEC 60335-1	Safety of electrical appliances for household and similar purposes. Meets the requirements for appliances in unattended use. This includes the enhanced requirements of glow wire tests acc. to IEC 60695-2-11 or -12 & -13.

## Compliances

The product complies with following Guide Lines

Identification	Details	Initiator	Description
	CE declaration of conformity	SCHURTER AG	The CE marking declares that the product complies with the applicable requirements laid down in the harmonisation of Community legislation on its affixing in accordance with EU Regulation 765/2008.
	UKCA declaration of conformity	SCHURTER AG	The UKCA marking declares that the product complies with the applicable requirements laid down in the British Amendment of Regulation (EC) 765/2008.
	RoHS	SCHURTER AG	Directive RoHS 2011/65/EU, Amendment (EU) 2015/863
	China RoHS	SCHURTER AG	The law SJ / T 11363-2006 (China RoHS) has been in force since 1 March 2007. It is similar to the EU directive RoHS.
	REACH	SCHURTER AG	On 1 June 2007, Regulation (EC) No 1907/2006 on the Registration, Evaluation, Authorization and Restriction of Chemicals 1 (abbreviated as "REACH") entered into force.
	White Paper Glow wire test	SCHURTER AG	Meets the requirements of IEC 60335-1 for appliances in unattended use. This includes the enhanced requirements of glow wire tests acc. to IEC 60695-2-11 or -12 & -13.
	Medical Equipment	SCHURTER AG	Suitable for use in medical equipment according to IEC/UL 60601-1 (1 MOOP, 1 MOPP)

**Dimensions [mm]**

Screw-on mounting

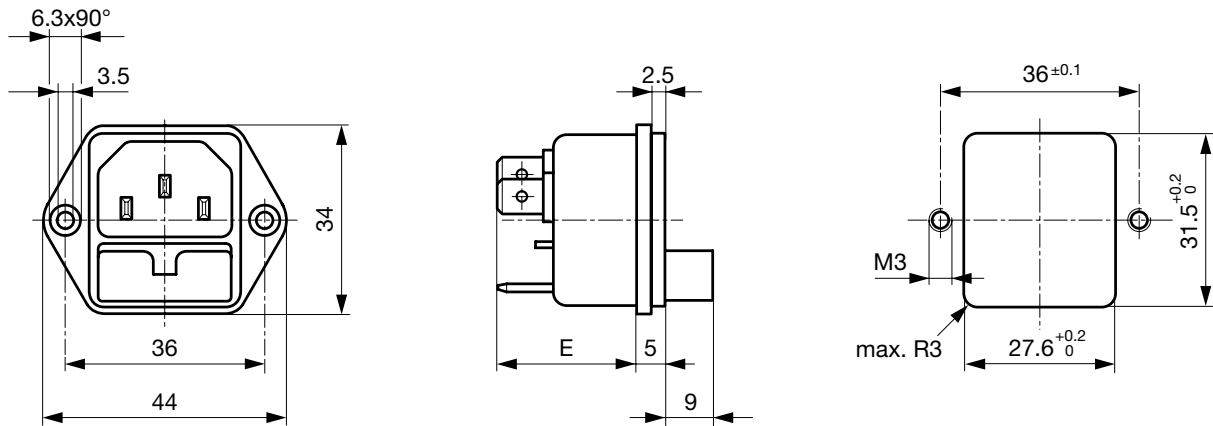

E: Solder terminals 20.5 mm  
 E: Quick connect terminals 23.5 mm

Snap-in mounting

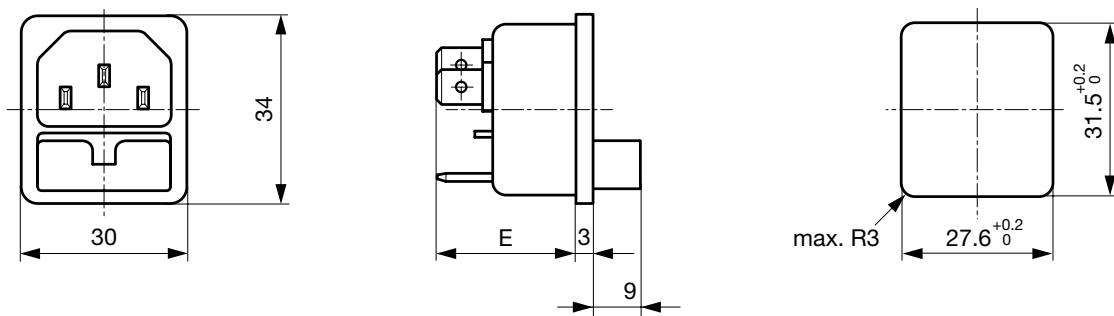

E: solder terminals 22.5 mm  
 E: quick-connect terminals 25.5 mm  
 S: 1.0/1.5/2.0/2.5/3.0 mm

**Diagrams**

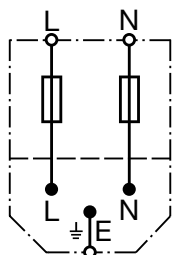

## Derating Curves

1-pole

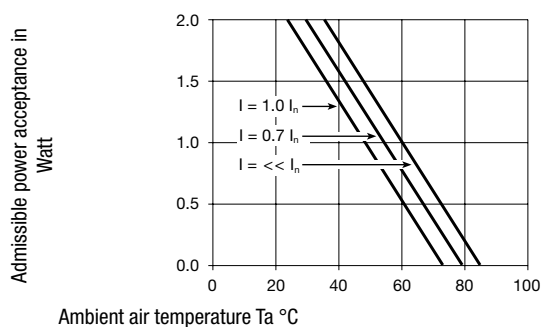

2-pole

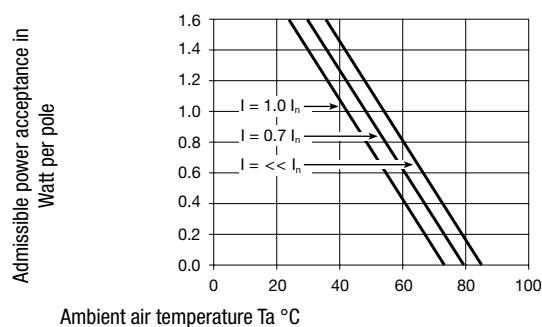

## All Variants

Protection Class	Panel mounting	Panel Thickness s [mm]	Fuseholder	Terminal	Internally wired	Order Number
I	Snap-in	1	2-pole	Quick connect terminals 4.8 x 0.8 mm	●	6220.5210
I	Snap-in	1.5	2-pole	Quick connect terminals 4.8 x 0.8 mm	●	6220.5215
I	Snap-in	2	2-pole	Quick connect terminals 4.8 x 0.8 mm	●	6220.5220
I	Snap-in	2.5	2-pole	Quick connect terminals 4.8 x 0.8 mm	●	6220.5225
I	Snap-in	3	2-pole	Quick connect terminals 4.8 x 0.8 mm	●	6220.5230
I	Snap-in	1	2-pole	Quick connect terminals 6.3 x 0.8 mm	●	6220.5310
I	Snap-in	1.5	2-pole	Quick connect terminals 6.3 x 0.8 mm	●	6220.5315
I	Snap-in	2	2-pole	Quick connect terminals 6.3 x 0.8 mm	●	6220.5320
I	Snap-in	2.5	2-pole	Quick connect terminals 6.3 x 0.8 mm	●	6220.5325
I	Snap-in	3	2-pole	Quick connect terminals 6.3 x 0.8 mm	●	6220.5330
I	Snap-in	1	2-pole	Solder terminals 3.8 x 0.8 mm	●	6220.5110
I	Snap-in	1.5	2-pole	Solder terminals 3.8 x 0.8 mm	●	6220.5115
I	Snap-in	2	2-pole	Solder terminals 3.8 x 0.8 mm	●	6220.5120
I	Snap-in	2.5	2-pole	Solder terminals 3.8 x 0.8 mm	●	6220.5125
I	Snap-in	3	2-pole	Solder terminals 3.8 x 0.8 mm	●	6220.5130
I	Screw	-	2-pole	Quick connect terminals 4.8 x 0.8 mm	●	6220.2200
I	Screw	-	2-pole	Quick connect terminals 6.3 x 0.8 mm	●	6220.2300
I	Screw	-	2-pole	Solder terminals 3.8 x 0.8 mm	●	6220.2100

Most Popular.

Availability for all products can be searched real-time: <https://www.schurter.com/en/Stock-Check/Stock-Check-SCHURTER>

Packaging unit

50 Pcs

Accessories

Description



Assorted Covers  
 Rear Cover

0859.0047

4311.9403



RC320  
 Rear Cover for Power Entry Module



Cord retaining kits  
 Cord retaining strain relief

Flat head, A

4700.0001

Countersunk, B

4700.0002

Mating Outlets/Connectors

Category / Description

Appliance Outlet Overview complete



4787, Mounting: Screw-on mounting, Appliance Outlet: IEC Solder terminals, 10 A, Suitable for appliances with protection class I

4787

4788, Mounting: Snap-in version, Appliance Outlet: IEC Solder / Quick Connect, 10 A, Suitable for appliances with protection class I

4788

IEC Appliance Outlet F or H, Screw-on Mounting, Front Side, Solder, PCB or Quick-connect Terminal

5091

Connector Overview complete



4782 Mounting: Power Cord, 3 x 1 mm<sup>2</sup> / 3 x 18 AWG, Cable, Connector: IEC C13

4782

4785 Mounting: Power Cord, 3 x 1 mm<sup>2</sup> / 3 x 18 AWG, Cable, Connector: IEC C13

4785

4300-06 Mounting: Power Cord, 3 x 1 mm<sup>2</sup> / 3 x 18 AWG, Cable, Connector: IEC C13

4300-06

4781 Mounting: Power Cord, Cable, Connector: IEC C15

4781

4784 Mounting: Power Cord, 3 x 1 mm<sup>2</sup> / 3 x 18 AWG, Cable, Connector: IEC C15

4784

...