

High-Gain IGBTs w/Diode

IXGH50N60B4D1 IXGQ50N60B4D1

$V_{CES} = 600V$
 $I_{C110} = 50A$
 $V_{CE(sat)} \leq 1.8V$

Low-Vsat PT Trench IGBTs

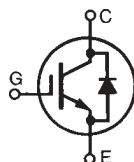

Symbol	Test Conditions	Maximum Ratings	
V_{CES}	$T_J = 25^\circ C$ to $150^\circ C$	600	V
V_{CGR}	$T_J = 25^\circ C$ to $150^\circ C$, $R_{GE} = 1M\Omega$	600	V
V_{GES}	Continuous	± 20	V
V_{GEM}	Transient	± 30	V
I_{C25}	$T_C = 25^\circ C$	100	A
I_{C110}	$T_C = 110^\circ C$	50	A
I_{F110}	$T_C = 110^\circ C$	18	A
I_{CM}	$T_C = 25^\circ C$, 1ms	230	A
SSOA (RBSOA)	$V_{GE} = 15V$, $T_{VJ} = 125^\circ C$, $R_G = 10\Omega$ Clamped Inductive Load	$I_{CM} = 72$ $V_{CE} \leq V_{CES}$	A
P_C	$T_C = 25^\circ C$	300	W
T_J		-55 ... +150	$^\circ C$
T_{JM}		150	$^\circ C$
T_{stg}		-55 ... +150	$^\circ C$
T_L	Maximum Lead Temperature for Soldering	300	$^\circ C$
T_{SOLD}	1.6 mm (0.062in.) from Case for 10s	260	$^\circ C$
M_d	Mounting Torque	1.13/10	Nm/lb.in.
Weight	TO-247	6.0	g
	TO-3P	5.5	g

TO-247 (IXGH)

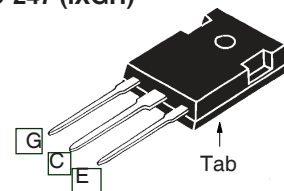

TO-3P (IXGQ)

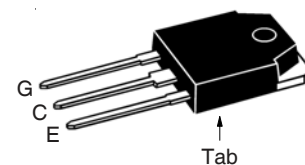

G = Gate C = Collector
 E = Emitter Tab = Collector

Features

- Optimized for Low Conduction and Switching Losses
- Anti-Parallel Ultra Fast Diode
- Square RBSOA

Advantages

- Easy to Mount
- Space Savings

Applications

- Power Inverters
- UPS
- Motor Drives
- SMPS
- PFC Circuits
- Battery Chargers
- Lamp Ballasts

Symbol	Test Conditions ($T_J = 25^\circ C$, Unless Otherwise Specified)	Characteristic Values		
		Min.	Typ.	Max.
$V_{GE(th)}$	$I_C = 250\mu A$, $V_{CE} = V_{GE}$	4.0		6.5 V
I_{CES}	$V_{CE} = V_{CES}$, $V_{GE} = 0V$ $T_J = 125^\circ C$			50 μA 2.5 mA
I_{GES}	$V_{CE} = 0V$, $V_{GE} = \pm 20V$			± 100 nA
$V_{CE(sat)}$	$I_C = 36A$, $V_{GE} = 15V$, Note 1 $T_J = 125^\circ C$		1.4 1.4	1.8 V V

Symbol Test Conditions
 $(T_J = 25^\circ\text{C Unless Otherwise Specified})$
Characteristic Values

		Min.	Typ.	Max.	
g_{fs}	$I_C = 36\text{A}, V_{CE} = 10\text{V}, \text{Note 1}$	20	30		S
C_{ies}	$V_{CE} = 25\text{V}, V_{GE} = 0\text{V}, f = 1\text{MHz}$		1860		pF
C_{oes}			105		pF
C_{res}			60		pF
Q_g	$I_C = I_{C110}, V_{GE} = 15\text{V}, V_{CE} = 0.5 \cdot V_{CES}$		110		nC
Q_{ge}			13		nC
Q_{gc}			43		nC
$t_{d(on)}$	Inductive Load, $T_J = 25^\circ\text{C}$ $I_C = 36\text{A}, V_{GE} = 15\text{V}$ $V_{CE} = 400\text{V}, R_G = 10\Omega$ Note 2		37		ns
t_{ri}			68		ns
E_{on}			0.93		mJ
$t_{d(off)}$			330		ns
t_{fi}			80		ns
E_{off}			1.00	1.80	mJ
$t_{d(on)}$	Inductive Load, $T_J = 125^\circ\text{C}$ $I_C = 36\text{A}, V_{GE} = 15\text{V}$ $V_{CE} = 400\text{V}, R_G = 10\Omega$ Note 2		31		ns
t_{ri}			45		ns
E_{on}			0.94		mJ
$t_{d(off)}$			280		ns
t_{fi}			220		ns
E_{off}			1.90		mJ
R_{thJC}				0.42	$^\circ\text{C/W}$
R_{thCS}		0.25			$^\circ\text{C/W}$

Reverse Diode (FRED)
Symbol Test Conditions
 $(T_J = 25^\circ\text{C Unless Otherwise Specified})$
Characteristic Values

		Min.	Typ.	Max.	
V_F	$I_F = 15\text{A}, V_{GE} = 0\text{V}, \text{Note 1}$		1.6	2.7	V
I_{RM}	$I_F = 15\text{A}, V_{GE} = 0\text{V}, -di_F/dt = 100\text{A}/\mu\text{s}, T_J = 100^\circ\text{C}$			2.6	A
t_{rr}	$V_R = 100\text{V}, T_J = 100^\circ\text{C}$		100		ns
	$I_F = 1\text{A}, V_{GE} = 0\text{V}, -di_F/dt = 100\text{A}/\mu\text{s}, V_R = 30\text{V}$		25		ns
R_{thJC}				1.6	$^\circ\text{C/W}$

Notes:

1. Pulse test, $t \leq 300\mu\text{s}$, duty cycle, $d \leq 2\%$.
2. Switching times & energy losses may increase for higher $V_{CE}(\text{clamp})$, T_J or R_G .

IXYS Reserves the Right to Change Limits, Test Conditions, and Dimensions.

IXYS MOSFETs and IGBTs are covered by one or more of the following U.S. patents:	4,835,592	4,931,844	5,049,961	5,237,481	6,162,665	6,404,065 B1	6,683,344	6,727,585	7,005,734 B2	7,157,338B2
	4,850,072	5,017,508	5,063,307	5,381,025	6,259,123 B1	6,534,343	6,710,405 B2	6,759,692	7,063,975 B2	
	4,881,106	5,034,796	5,187,117	5,486,715	6,306,728 B1	6,583,505	6,710,463	6,771,478 B2	7,071,537	

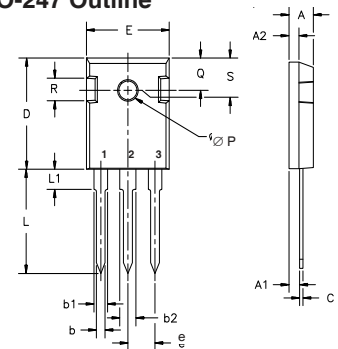
TO-247 Outline

 Terminals: 1 - Gate 2 - Collector
 3 - Emitter

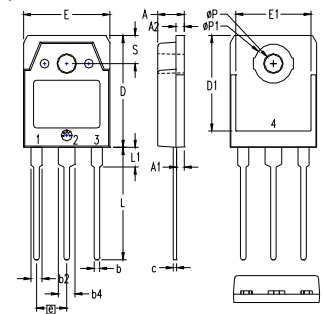
Dim.	Millimeter		Inches	
	Min.	Max.	Min.	Max.
A	4.7	5.3	.185	.209
A ₁	2.2	2.54	.087	.102
A ₂	2.2	2.6	.059	.098
b	1.0	1.4	.040	.055
b ₁	1.65	2.13	.065	.084
b ₂	2.87	3.12	.113	.123
C	.4	.8	.016	.031
D	20.80	21.46	.819	.845
E	15.75	16.26	.610	.640
e	5.20	5.72	0.205	0.225
L	19.81	20.32	.780	.800
L1		4.50		.177
∅P	3.55	3.65	.140	.144
Q	5.89	6.40	0.232	0.252
R	4.32	5.49	.170	.216
S	6.15	BSC	242	BSC

TO-3P Outline

 1 = Gate 2,4 = Collector
 3 = Emitter

SYM	INCHES		MILLIMETERS	
	MIN	MAX	MIN	MAX
A	.185	.193	4.70	4.90
A1	.051	.059	1.30	1.50
A2	.057	.065	1.45	1.65
b	.035	.045	0.90	1.15
b2	.075	.087	1.90	2.20
b4	.114	.126	2.90	3.20
c	.022	.031	0.55	0.80
D	.780	.799	19.80	20.30
D1	.665	.677	16.90	17.20
E	.610	.622	15.50	15.80
E1	.531	.539	13.50	13.70
e	.215 BSC		5.45 BSC	
L	.779	.795	19.80	20.20
L1	.134	.142	3.40	3.60
∅P	.126	.134	3.20	3.40
∅P1	.272	.280	6.90	7.10
S	.193	.201	4.90	5.10

Fig. 1. Output Characteristics @ $T_J = 25^\circ\text{C}$

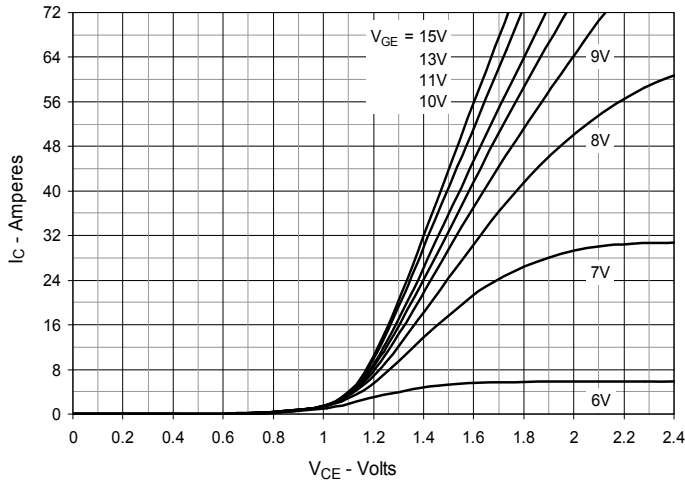

Fig. 2. Extended Output Characteristics @ $T_J = 25^\circ\text{C}$

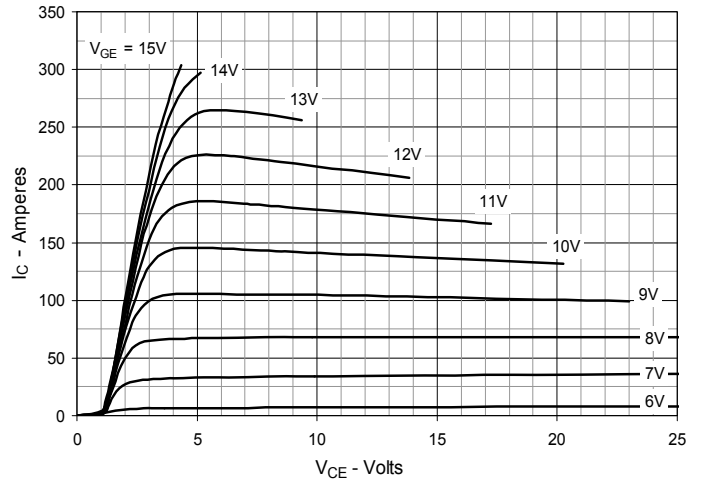

Fig. 3. Output Characteristics @ $T_J = 125^\circ\text{C}$

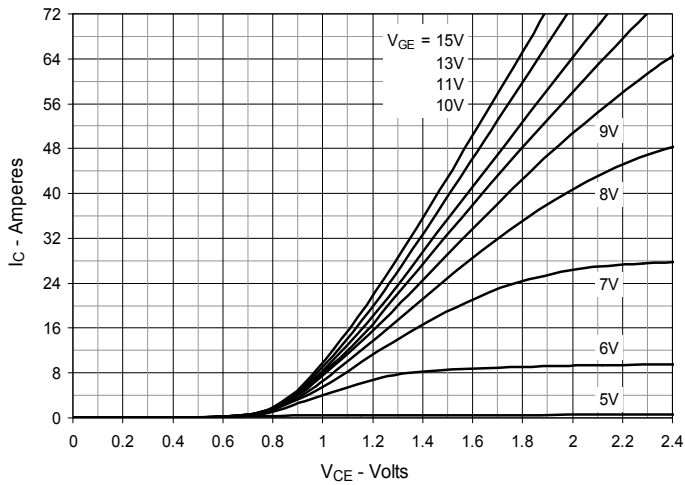

Fig. 4. Dependence of $V_{CE(sat)}$ on Junction Temperature

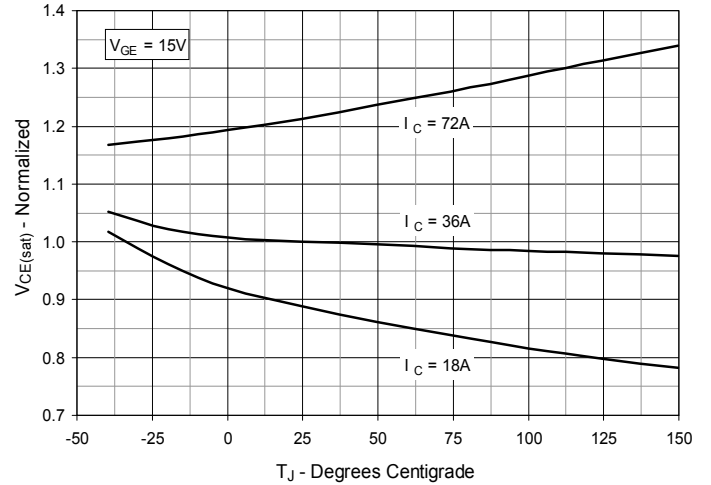

Fig. 5. Collector-to-Emitter Voltage vs. Gate-to-Emitter Voltage

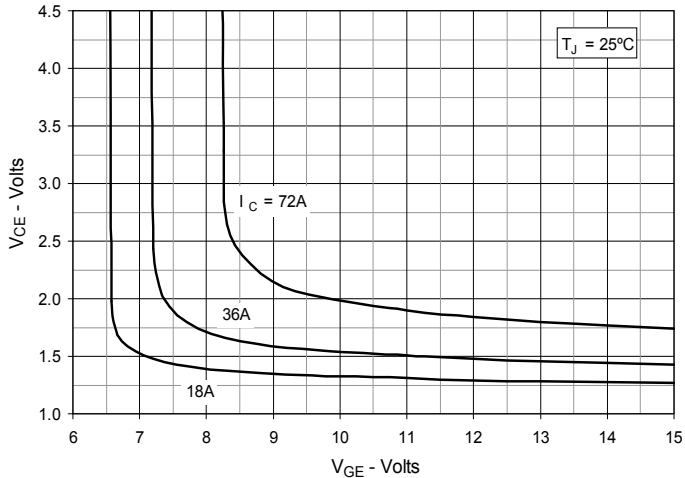

Fig. 6. Input Admittance

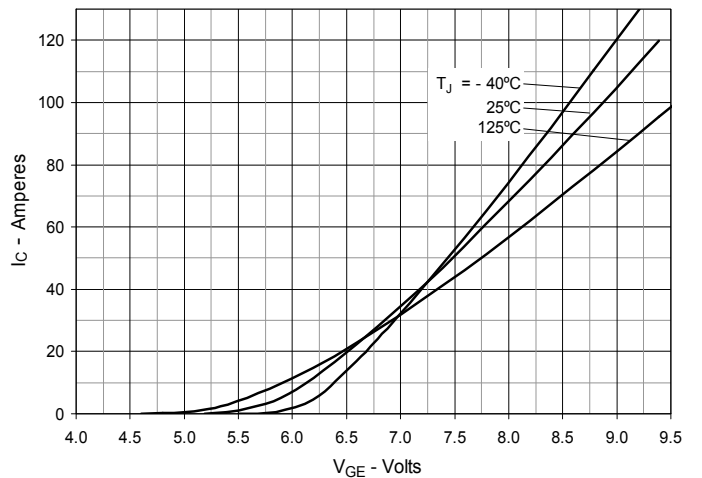

Fig. 7. Transconductance

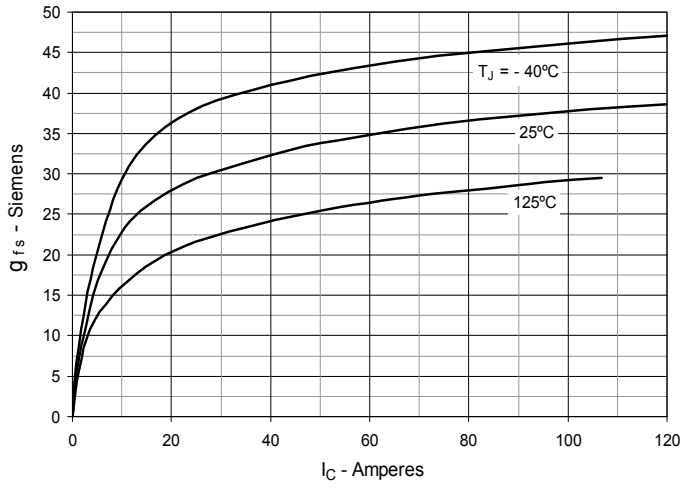

Fig. 8. Gate Charge

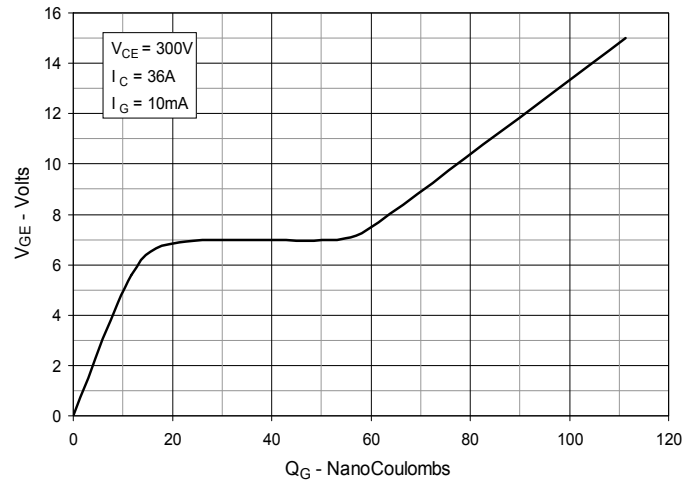

Fig. 9. Capacitance

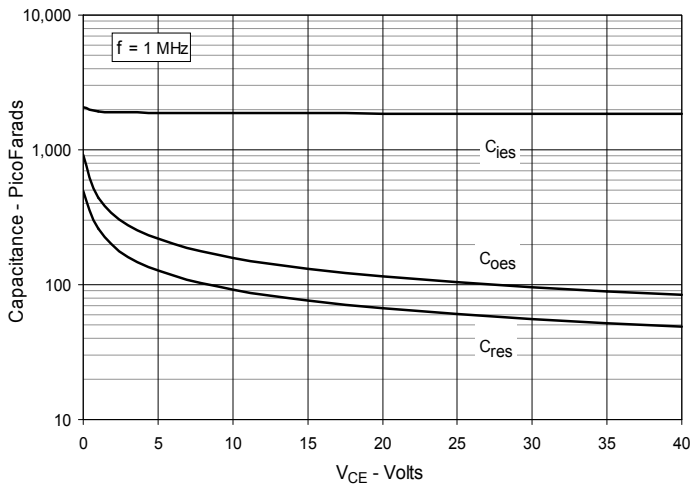

Fig. 10. Reverse-Bias Safe Operating Area

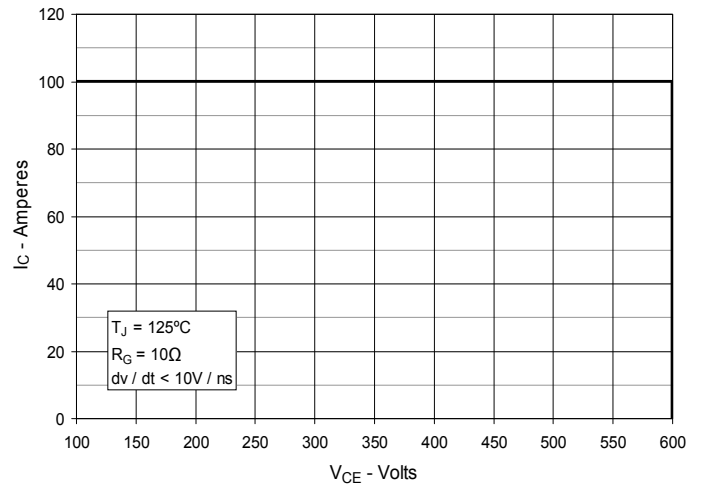

Fig. 11. Maximum Transient Thermal Impedance

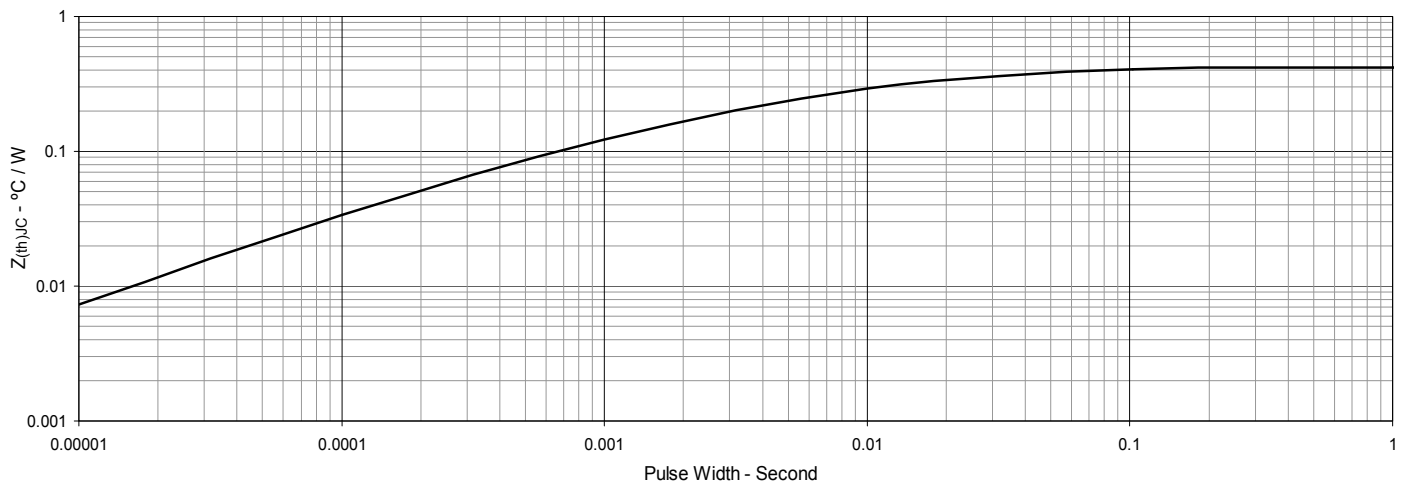

Fig. 12. Inductive Switching Energy Loss vs. Gate Resistance

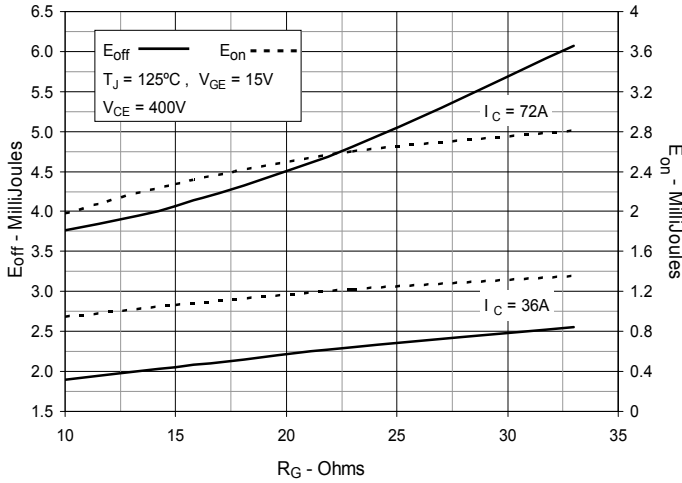

Fig. 13. Inductive Switching Energy Loss vs. Collector Current

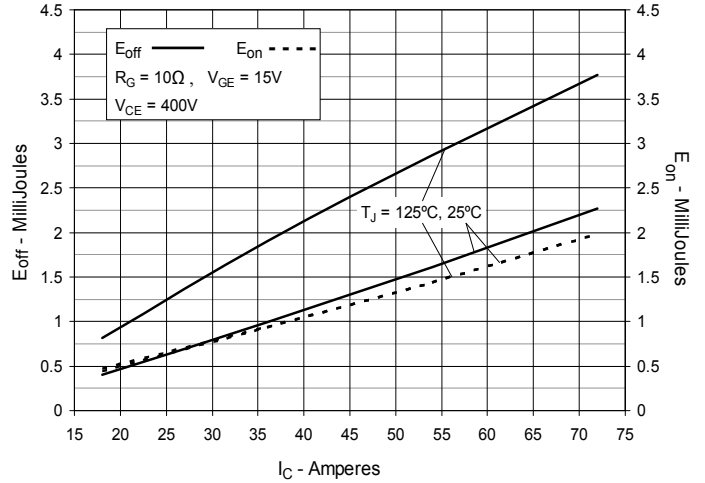

Fig. 14. Inductive Switching Energy Loss vs. Junction Temperature

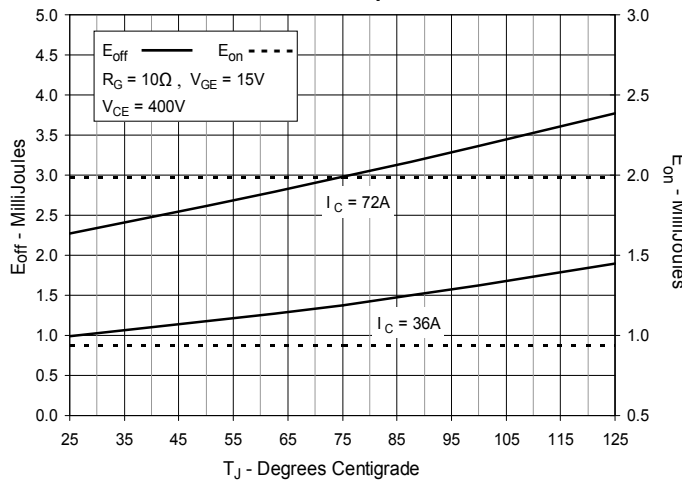

Fig. 15. Inductive Turn-off Switching Times vs. Gate Resistance

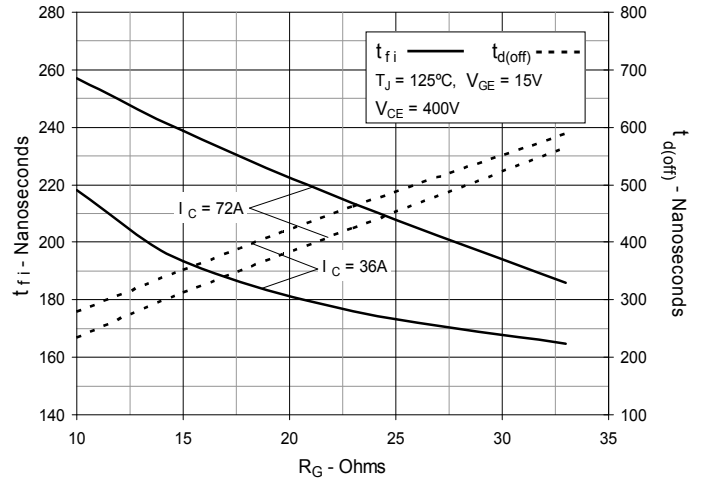

Fig. 16. Inductive Turn-off Switching Times vs. Collector Current

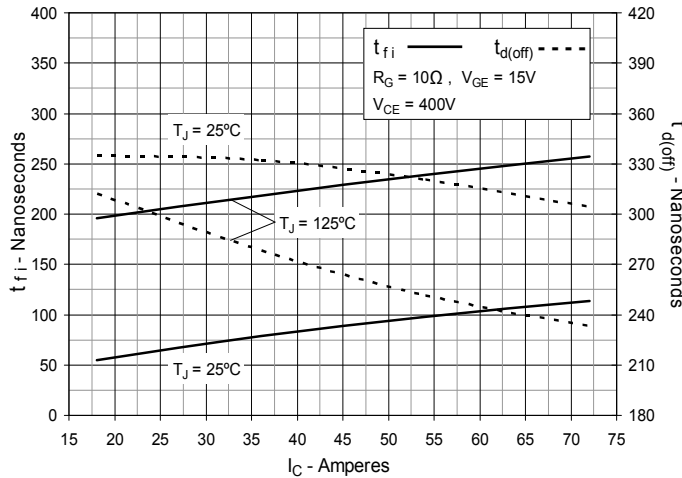

Fig. 17. Inductive Turn-off Switching Times vs. Junction Temperature

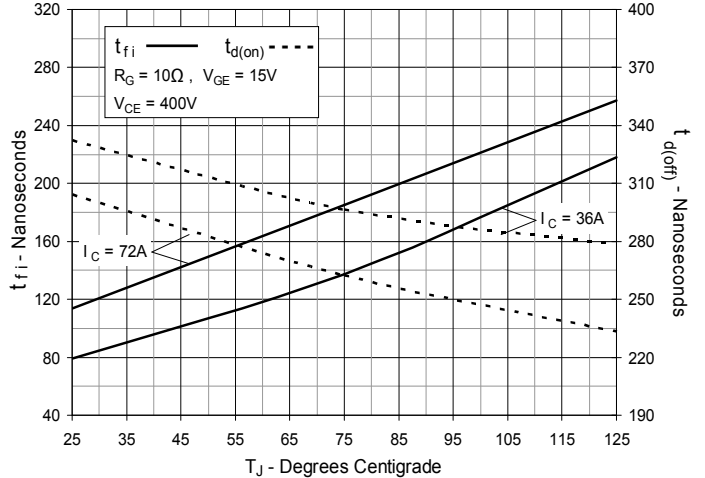

Fig. 18. Inductive Turn-on Switching Times vs. Gate Resistance

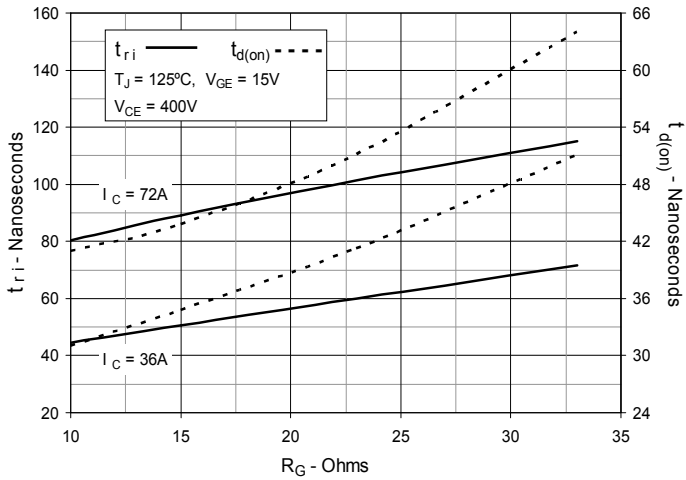

Fig. 19. Inductive Turn-on Switching Times vs. Collector Current

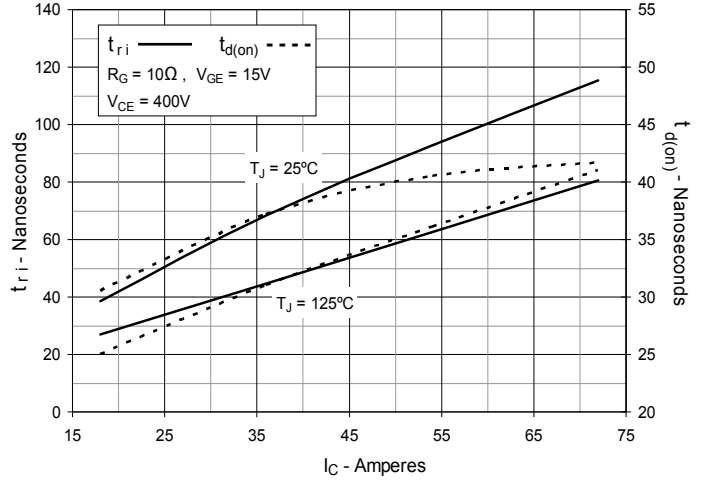

Fig. 20. Inductive Turn-on Switching Times vs. Junction Temperature

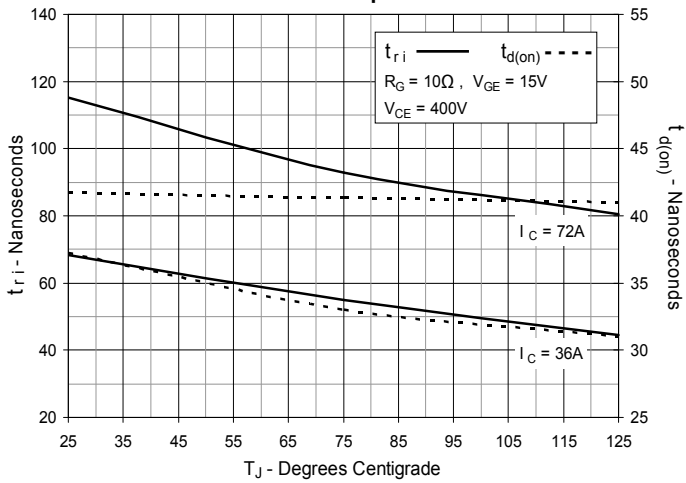

Fig. 21. Forward Voltage vs. Forward Current

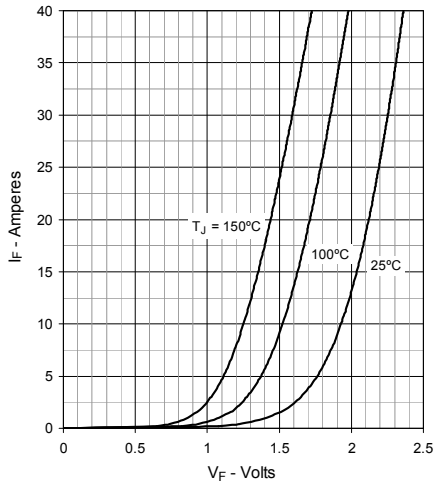

Fig. 22. Reverse Recovery Charge vs. $-di_F/dt$

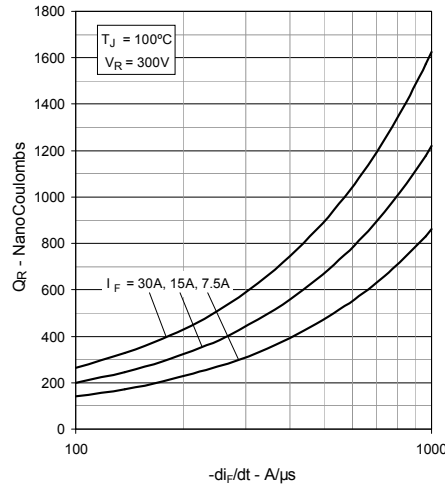

Fig. 23. Peak Reverse Current vs. $-di_F/dt$

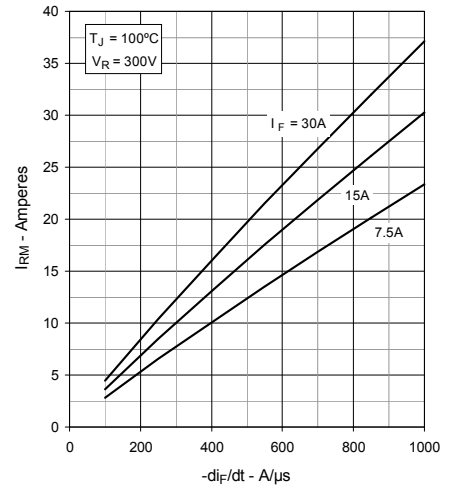

Fig. 24. Dynamic Parameter vs. Junction Temperature

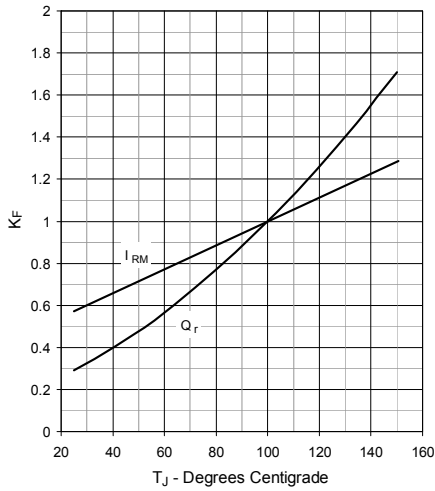

Fig. 25. Reverse Recovery Time vs. $-di_F/dt$

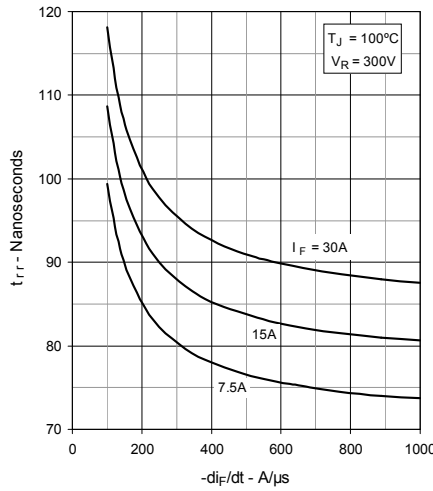

Fig. 26. Peak Forward Voltage & Forward Recovery Time vs. di_F/dt

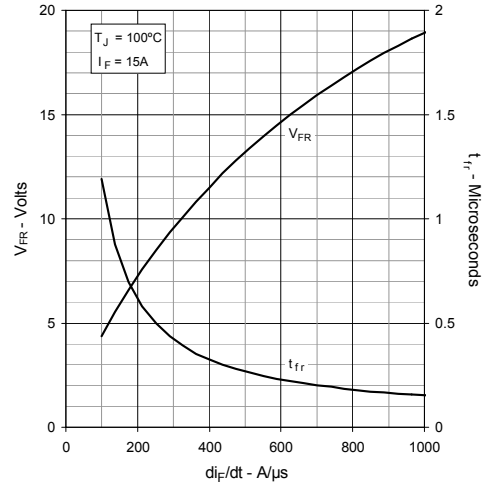

Fig. 27. Maximum Transient Thermal Impedance (for Diode)

