

25V PNP LOW SAT TRANSISTOR WITH N-CHANNEL MOSFET

Features

- Combination of PNP low $V_{CE(sat)}$ Transistor and N-Channel MOSFET
- Very low collector-emitter saturation voltage $V_{CE(sat)}$
- High Collector Current Capability I_C and I_{CM}
- High Collector Current Gain (h_{FE}) at high I_C
- P_D up to 2.47W for power demanding applications
- **Totally Lead-Free & Fully RoHS Compliant (Notes 1 & 2)**
- **Halogen and Antimony Free. "Green" Device (Note 3)**

Mechanical Data

- Case: U-DFN2020-6 (Type B)
- UL Flammability Rating 94V-0
- Case Material: Molded Plastic. "Green" Molding Compound.
- Moisture Sensitivity: Level 1 per J-STD-020
- Terminals: Finish - NiPdAu, Solderable per MIL-STD-202, Method 208 (e4)
- Weight: 0.007 grams (Approximate)

U-DFN2020-6
(Type B)

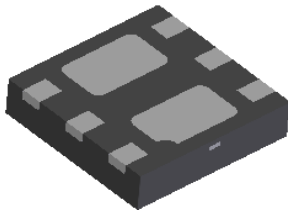

Top View

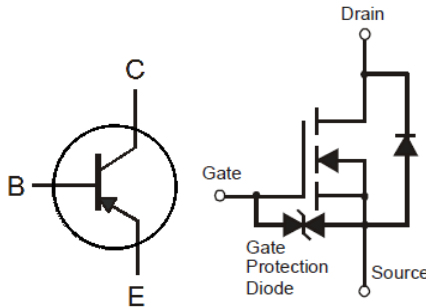

Device Symbol

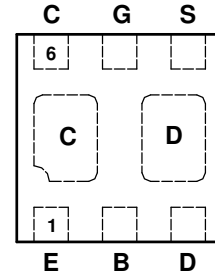

Top View
Pin-Out

Ordering Information (Note 4)

Product	Marking	Reel size (inches)	Tape width (mm)	Quantity per reel
DTM3A25P20NFDB-7	1W1	7	8	3,000

- Notes:
1. No purposely added lead. Fully EU Directive 2002/95/EC (RoHS) & 2011/65/EU (RoHS 2) compliant.
 2. See http://www.diodes.com/quality/lead_free.html for more information about Diodes Incorporated's definitions of Halogen- and Antimony-free, "Green" and Lead-free.
 3. Halogen- and Antimony-free "Green" products are defined as those which contain <900ppm bromine, <900ppm chlorine (<1500ppm total Br + Cl) and <1000ppm antimony compounds.
 4. For packaging details, go to our website at <http://www.diodes.com/products/packages.html>.

Marking Information

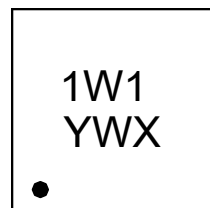

- 1W1 = Product Type Marking Code
- Y = Year: 0~9 (Last Digit of the Year)
- W = Week: A~Z: Week 1~26;
a~z: Week 27~52 ;
z represents week 52 and 53
- X = A~Z: Internal Code

BJT Absolute Maximum Ratings (@T_A = +25°C, unless otherwise specified.)

Characteristic	Symbol	Value	Unit
Collector-Base Voltage	V _{CBO}	-35	V
Collector-Emitter Voltage	V _{CEO}	-25	V
Emitter-Base Voltage	V _{EBO}	-7	V
Continuous Collector Current	I _C	-3	A
Peak Pulse Current	I _{CM}	-6	A
Base Current	I _B	-500	mA

MOSFET Absolute Maximum Ratings (@T_A = +25°C, unless otherwise specified.)

Characteristic	Symbol	Value	Units
Drain-Source Voltage	V _{DSS}	20	V
Gate-Source Voltage	V _{GSS}	±6	V
Continuous Drain Current (Note 5) V _{GS} = 10 V	I _D	@T _A = +25°C 0.63	A
		@T _A = +85°C 0.45	
Pulsed Drain Current	I _{DM}	6	A

Thermal Characteristics (@T_A = +25°C, unless otherwise specified.)

Characteristic	Symbol	Value	Unit
Power Dissipation	P _D	(Notes 5 & 7) 405	mW
		(Notes 5 & 8) 510	
		(Notes 6 & 7) 1,650	
		(Notes 6 & 8) 2,470	
Thermal Resistance, Junction to Ambient	R _{θJA}	(Notes 5 & 7) 308	°C/W
		(Notes 5 & 8) 245	
		(Notes 6 & 7) 76	
	(Notes 6 & 8) 51		
Thermal Resistance, Junction to Lead	(Note 9) R _{θJL}	18	°C/W
Operating and Storage Temperature Range	T _J , T _{STG}	-55 to +150	°C

ESD Ratings (Note 10)

Characteristic	Symbol	Value	Unit	JEDEC Class
Electrostatic Discharge – Human Body Model	ESD HBM	3,000	V	3A
Electrostatic Discharge – Machine Model	ESD MM	200	V	C

- Notes:
- For a device mounted with the exposed collector pads on minimum recommended pad layout that is on a single-sided 1.6mm FR4 PCB; device is measured under still air conditions whilst operating in a steady-state.
 - Same as note (5), except the device is mounted with the collector pad on 28mm x 28mm (8cm²) 2oz copper.
 - For a dual device with one active die.
 - For dual device with 2 active die running at equal power.
 - Thermal resistance from junction to solder-point (on the exposed collector pads).
 - Refer to JEDEC specification JESD22-A114 and JESD22-A115.

Thermal Characteristics and Derating information

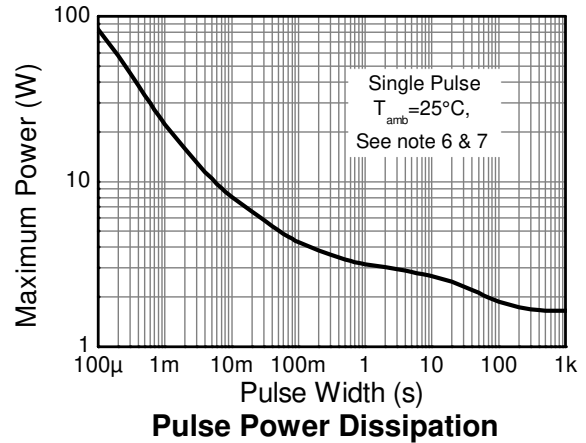
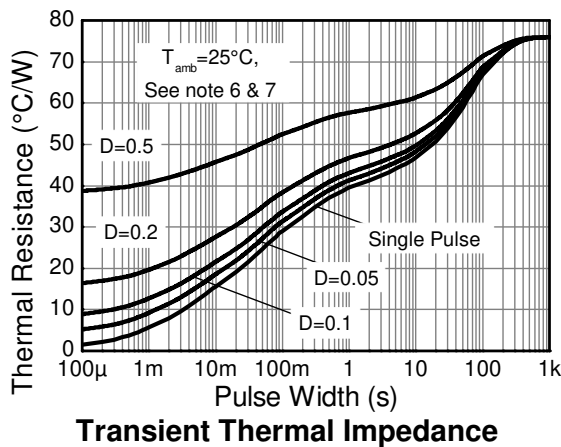
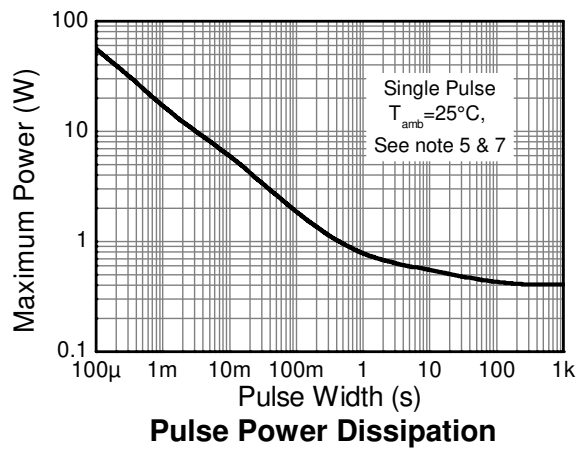
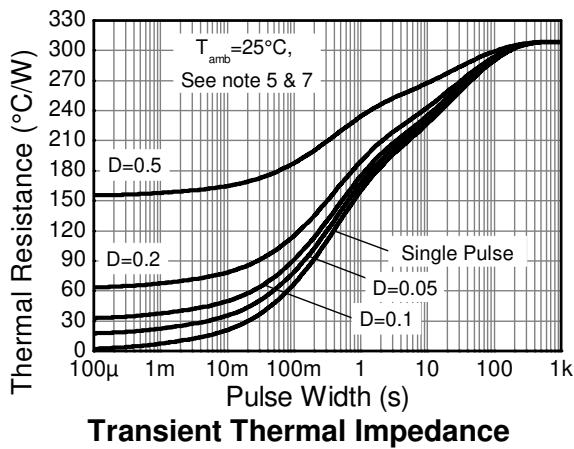
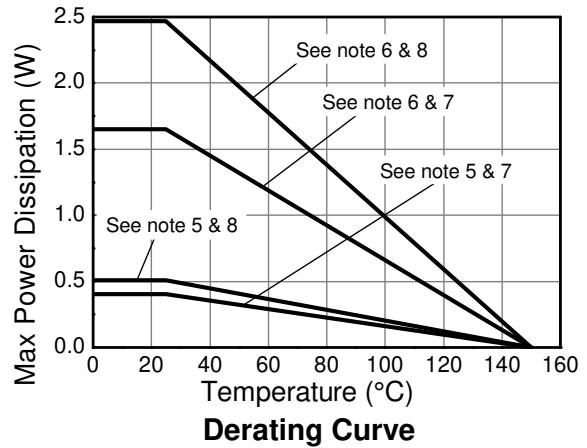
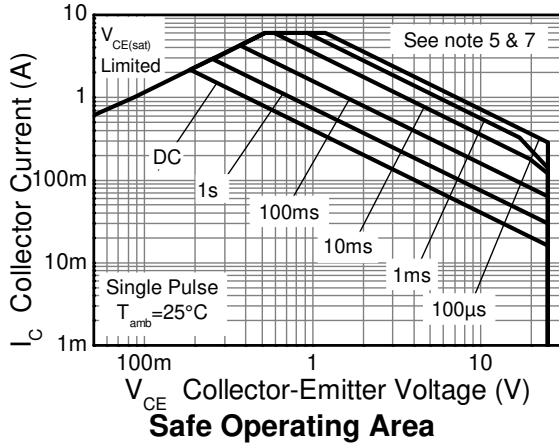

Typical Electrical Characteristics - BJT PNP (@T_A = +25°C, unless otherwise specified.)

Characteristic	Symbol	Min	Typ	Max	Unit	Test Condition
Collector-Base Breakdown Voltage	BV _{CBO}	-35	-60	-	V	I _C = -100μA
Collector-Emitter Breakdown Voltage (Note 11)	BV _{CEO}	-25	-40	-	V	I _C = -10mA
Emitter-Base Breakdown Voltage	BV _{EBO}	-7	-8.4	-	V	I _E = -100μA
Collector Cutoff Current	I _{CBO}	-	<1	-50 -0.5	nA μA	V _{CB} = -28V V _{CB} = -28V, T _A = +100°C
Emitter Cutoff Current	I _{EBO}	-	<1	-50	nA	V _{EB} = -5.6V
Collector Emitter Cutoff Current	I _{CES}	-	-	-100	nA	V _{CE} = -32V
Static Forward Current Transfer Ratio (Note 11)	h _{FE}	200 130 100 25	320 230 180 50	500 - - -	-	I _C = -100mA, V _{CE} = -2V I _C = -1A, V _{CE} = -2V I _C = -2A, V _{CE} = -2V I _C = -6A, V _{CE} = -2V
Collector-Emitter Saturation Voltage (Note 11)	V _{CE(sat)}	-	-85 -229	-150 -350	mV	I _C = -1A, I _B = -100mA I _C = -3A, I _B = -300mA
Base-Emitter Turn-On Voltage (Note 11)	V _{BE(on)}	-	-786	-850	mV	I _C = -1A, V _{CE} = -5V
Base-Emitter Saturation Voltage (Note 11)	V _{BE(sat)}	-	-895	-1,000	mV	I _C = -1A, I _B = -100mA

Note: 11. Measured under pulsed conditions. Pulse width ≤ 300 μs. Duty cycle ≤ 2%.

Typical Electrical Characteristics - BJT PNP (@T_A = +25°C, unless otherwise specified.)

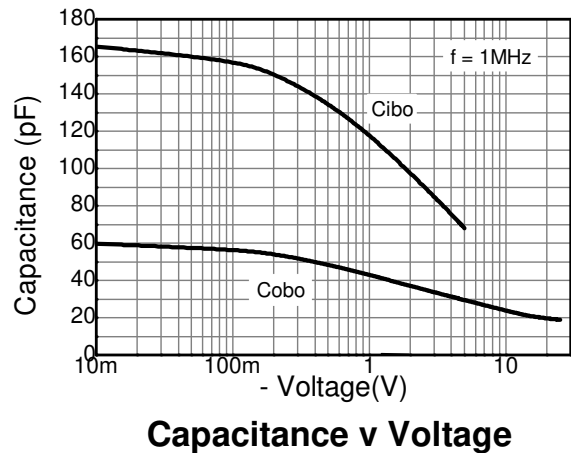
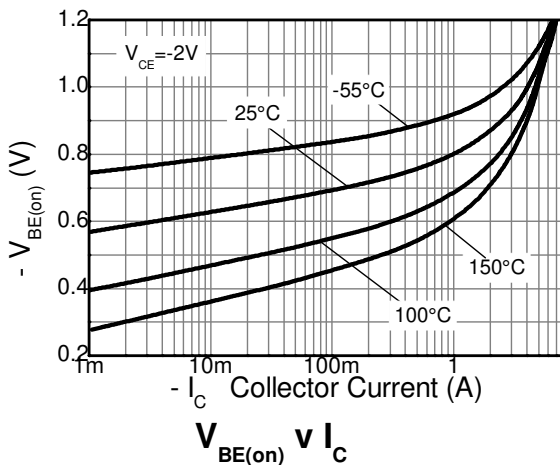
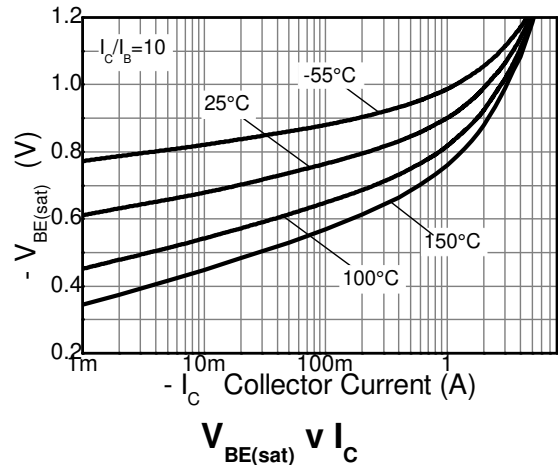
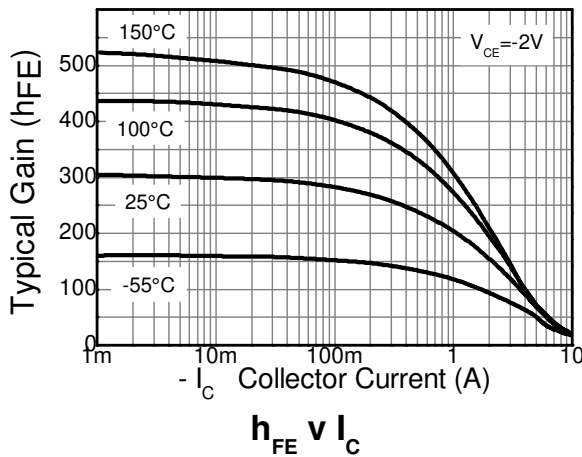
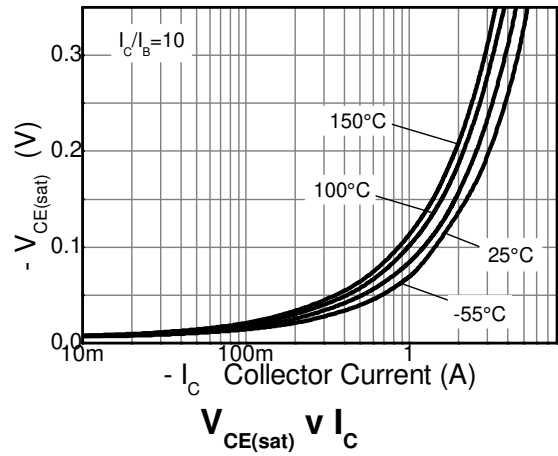
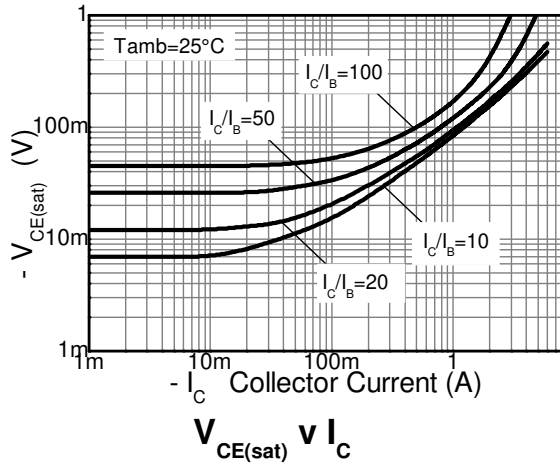

Typical Electrical Characteristics – MOS N-Channel (@T_A = +25°C, unless otherwise specified.)

Characteristic	Symbol	Min	Typ	Max	Unit	Test Condition
OFF CHARACTERISTICS (Note 12)						
Drain-Source Breakdown Voltage	BV _{DSS}	20	—	—	V	V _{GS} = 0V, I _D = 250μA
Zero Gate Voltage Drain Current T _J = +25°C	I _{DSS}	—	—	100	nA	V _{DS} = 20V, V _{GS} = 0V
Gate-Source Leakage	I _{GSS}	—	—	±1.0	μA	V _{GS} = ±4.5V, V _{DS} = 0V
ON CHARACTERISTICS (Note 12)						
Gate Threshold Voltage	V _{GS(th)}	0.5	—	1.0	V	V _{DS} = V _{GS} , I _D = 250μA
Static Drain-Source On-Resistance	R _{DS(ON)}	—	0.3	0.4	Ω	V _{GS} = 4.5V, I _D = 600mA
			0.4	0.5		V _{GS} = 2.5V, I _D = 500mA
			0.5	0.7		V _{GS} = 1.8V, I _D = 350mA
Forward Transfer Admittance	Y _{FS}	—	1.4	—	S	V _{DS} = 10V, I _D = 400mA
Diode Forward Voltage	V _{SD}	—	0.7	1.2	V	V _{GS} = 0V, I _D = 150mA
DYNAMIC CHARACTERISTICS (Note 13)						
Input Capacitance	C _{iss}	—	60.67	—	pF	V _{DS} = 16V, V _{GS} = 0V f = 1.0MHz
Output Capacitance	C _{oss}	—	9.68	—	pF	
Reverse Transfer Capacitance	C _{rss}	—	5.37	—	pF	
Total Gate Charge	Q _G	—	736.6	—	pC	V _{GS} = 4.5V, V _{DS} = 10V, I _D = 250mA
Gate-to-Source Charge	Q _{GS}	—	93.6	—	pC	
Gate-to-Drain Charge	Q _{GD}	—	116.6	—	pC	
SWITCHING CHARACTERISTICS						
Turn-On Delay Time	t _{d(on)}	—	5.1	—	ns	V _{DD} = 10V, V _{GS} = 4.5V, R _L = 47Ω, R _G = 10Ω, I _D = 200mA
Rise Time	t _r	—	7.4	—		
Turn-Off Delay Time	t _{d(off)}	—	26.7	—		
Fall Time	t _f	—	12.3	—		

- Notes: 12. Short duration pulse test used to minimize self-heating effect.
13. Guaranteed by design. Not subject to production testing.

Typical Electrical Characteristics – MOS N-Channel (@ $T_A = +25^\circ\text{C}$, unless otherwise specified.)

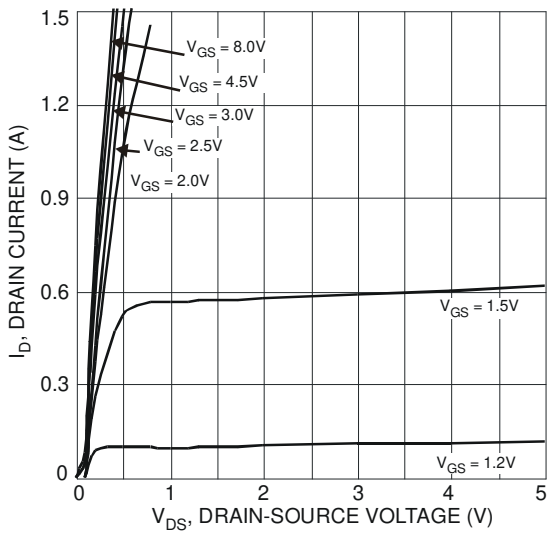

Fig. 1 Typical Output Characteristics

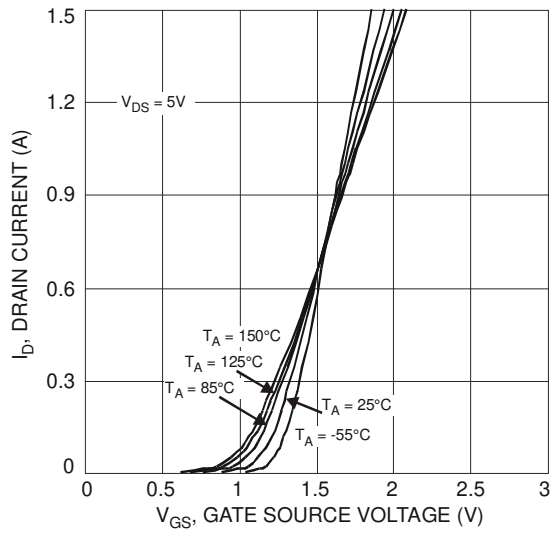

Fig. 2 Typical Transfer Characteristics

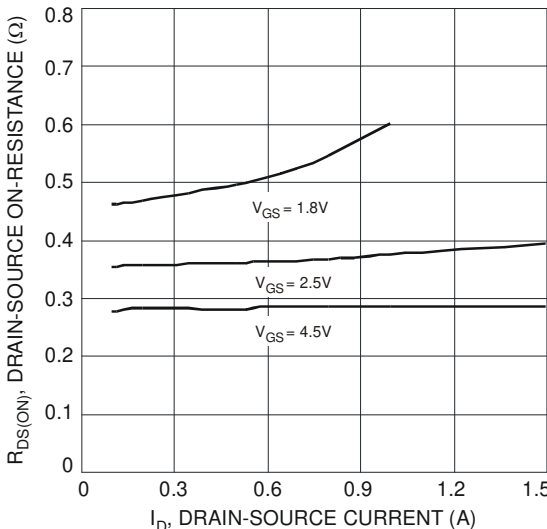

Fig. 3 Typical On-Resistance vs. Drain Current and Gate Voltage

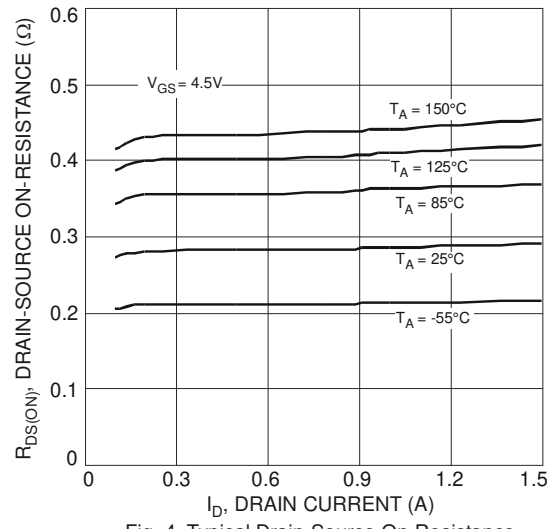

Fig. 4 Typical Drain-Source On-Resistance vs. Drain Current and Temperature

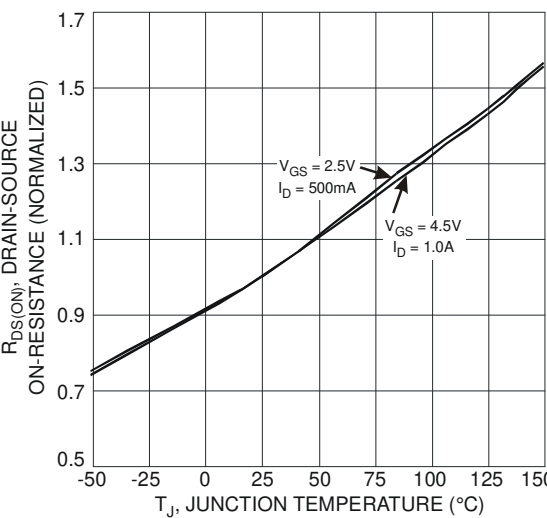

Fig. 5 On-Resistance Variation with Temperature

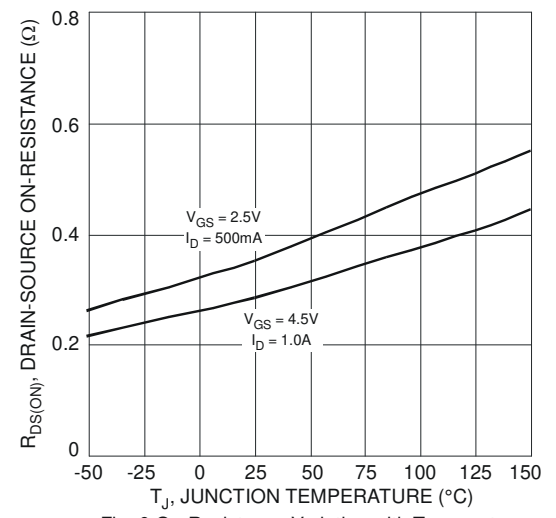

Fig. 6 On-Resistance Variation with Temperature

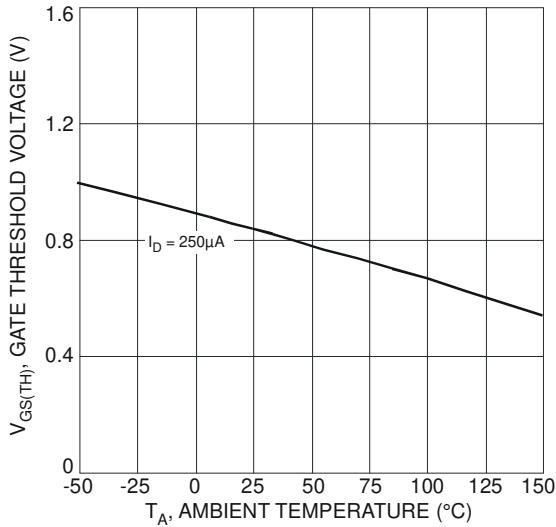

Fig. 7 Gate Threshold Variation vs. Ambient Temperature

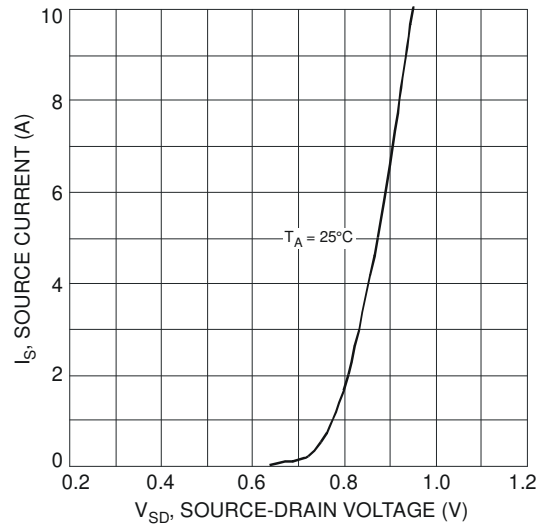

Fig. 8 Diode Forward Voltage vs. Current

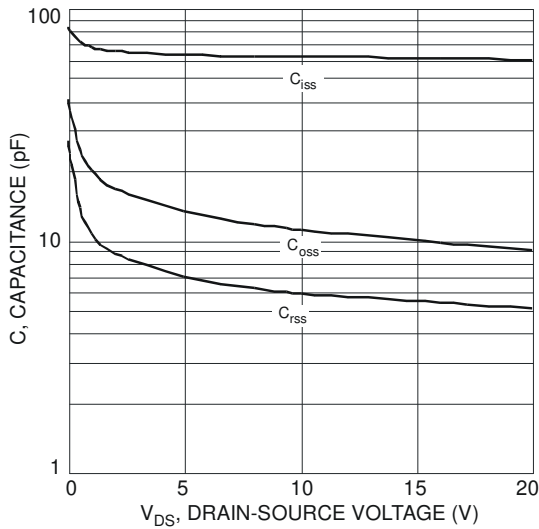

Fig. 9 Typical Capacitance

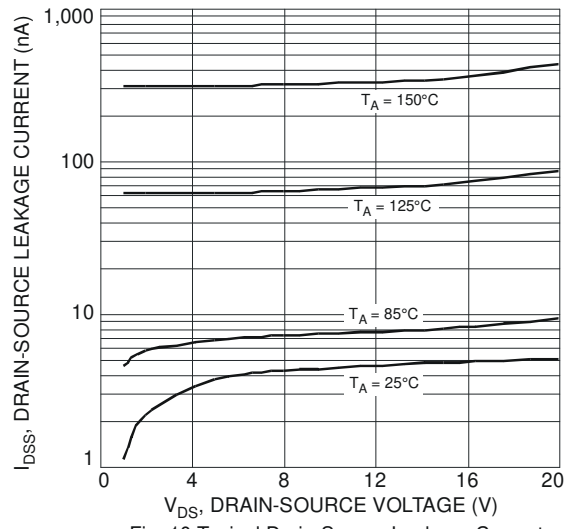

Fig. 10 Typical Drain-Source Leakage Current vs. Drain-Source Voltage

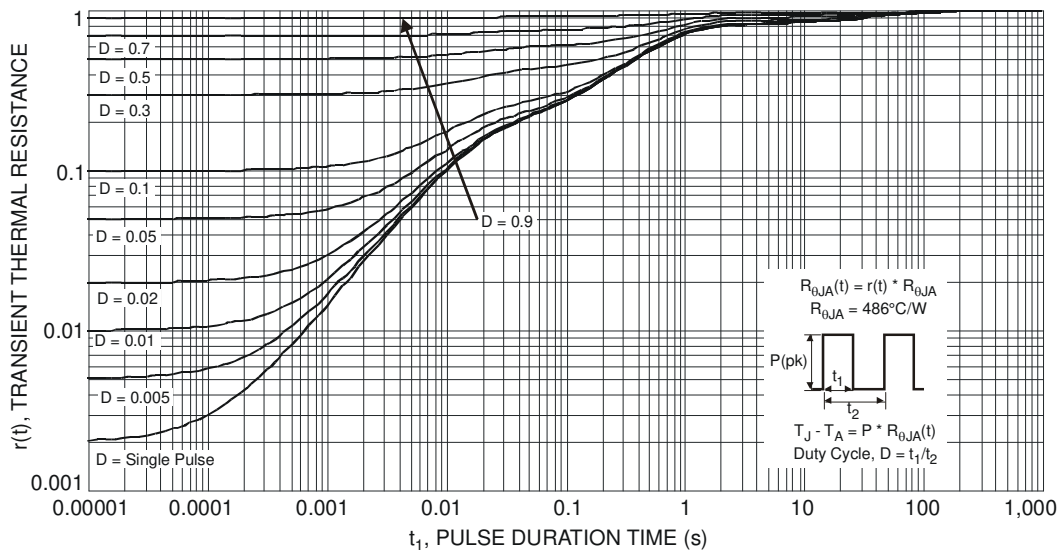
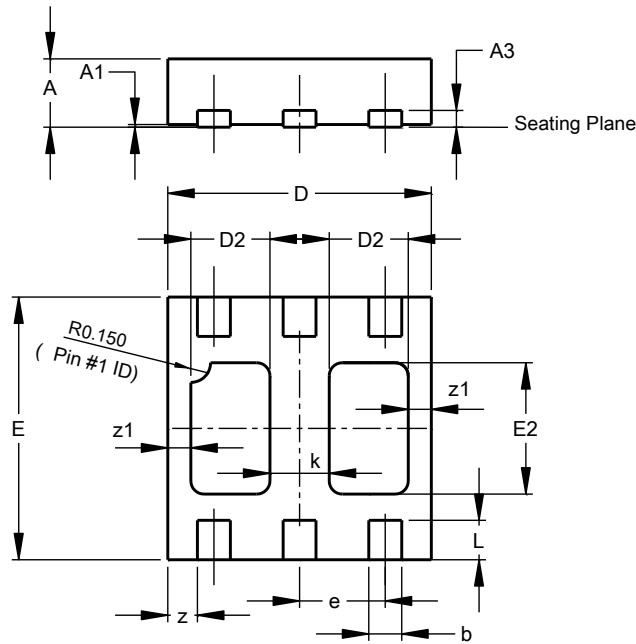

Fig. 11 Transient Thermal Response

Package Outline Dimensions

Please see <http://www.diodes.com/package-outlines.html> for the latest version.



U-DFN2020-6 Type B			
Dim	Min	Max	Typ
A	0.545	0.605	0.575
A1	0.00	0.05	0.02
A3	-	-	0.13
b	0.20	0.30	0.25
D	1.95	2.075	2.00
D2	0.50	0.70	0.60
e	-	-	0.65
E	1.95	2.075	2.00
E2	0.90	1.10	1.00
k	-	-	0.45
L	0.25	0.35	0.30
z	-	-	0.225
z1	-	-	0.175
All Dimensions in mm			

Suggested Pad Layout

Please see <http://www.diodes.com/package-outlines.html> for the latest version.

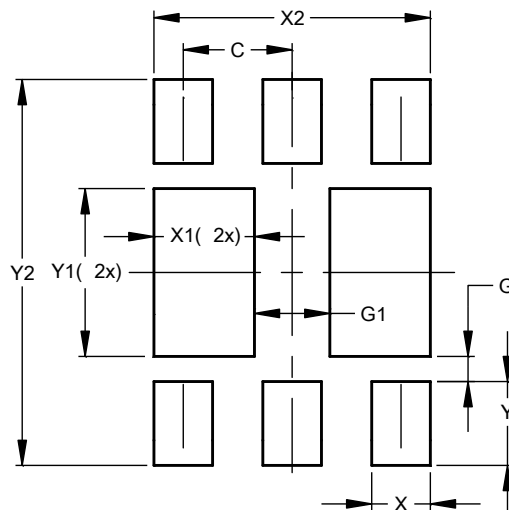

Dimensions	Value (in mm)
C	0.650
G	0.150
G1	0.450
X	0.350
X1	0.600
X2	1.650
Y	0.500
Y1	1.000
Y2	2.300

IMPORTANT NOTICE

DIODES INCORPORATED MAKES NO WARRANTY OF ANY KIND, EXPRESS OR IMPLIED, WITH REGARDS TO THIS DOCUMENT, INCLUDING, BUT NOT LIMITED TO, THE IMPLIED WARRANTIES OF MERCHANTABILITY AND FITNESS FOR A PARTICULAR PURPOSE (AND THEIR EQUIVALENTS UNDER THE LAWS OF ANY JURISDICTION).

Diodes Incorporated and its subsidiaries reserve the right to make modifications, enhancements, improvements, corrections or other changes without further notice to this document and any product described herein. Diodes Incorporated does not assume any liability arising out of the application or use of this document or any product described herein; neither does Diodes Incorporated convey any license under its patent or trademark rights, nor the rights of others. Any Customer or user of this document or products described herein in such applications shall assume all risks of such use and will agree to hold Diodes Incorporated and all the companies whose products are represented on Diodes Incorporated website, harmless against all damages.

Diodes Incorporated does not warrant or accept any liability whatsoever in respect of any products purchased through unauthorized sales channel. Should Customers purchase or use Diodes Incorporated products for any unintended or unauthorized application, Customers shall indemnify and hold Diodes Incorporated and its representatives harmless against all claims, damages, expenses, and attorney fees arising out of, directly or indirectly, any claim of personal injury or death associated with such unintended or unauthorized application.

Products described herein may be covered by one or more United States, international or foreign patents pending. Product names and markings noted herein may also be covered by one or more United States, international or foreign trademarks.

This document is written in English but may be translated into multiple languages for reference. Only the English version of this document is the final and determinative format released by Diodes Incorporated.

LIFE SUPPORT

Diodes Incorporated products are specifically not authorized for use as critical components in life support devices or systems without the express written approval of the Chief Executive Officer of Diodes Incorporated. As used herein:

A. Life support devices or systems are devices or systems which:

1. are intended to implant into the body, or
2. support or sustain life and whose failure to perform when properly used in accordance with instructions for use provided in the labeling can be reasonably expected to result in significant injury to the user.

B. A critical component is any component in a life support device or system whose failure to perform can be reasonably expected to cause the failure of the life support device or to affect its safety or effectiveness.

Customers represent that they have all necessary expertise in the safety and regulatory ramifications of their life support devices or systems, and acknowledge and agree that they are solely responsible for all legal, regulatory and safety-related requirements concerning their products and any use of Diodes Incorporated products in such safety-critical, life support devices or systems, notwithstanding any devices- or systems-related information or support that may be provided by Diodes Incorporated. Further, Customers must fully indemnify Diodes Incorporated and its representatives against any damages arising out of the use of Diodes Incorporated products in such safety-critical, life support devices or systems.

Copyright © 2016, Diodes Incorporated

www.diodes.com