

ANNA-40-7-W

~30° wide beam with 7 optics

SPECIFICATION:

Dimensions	Ø 40.0 mm
Height	10.7 mm
Fastening	pin
ROHS compliant	yes ⓘ

MATERIALS:

Component	Type	Material	Colour	Finish
ANNA-40-7-W	Multi-lens	PMMA	clear	



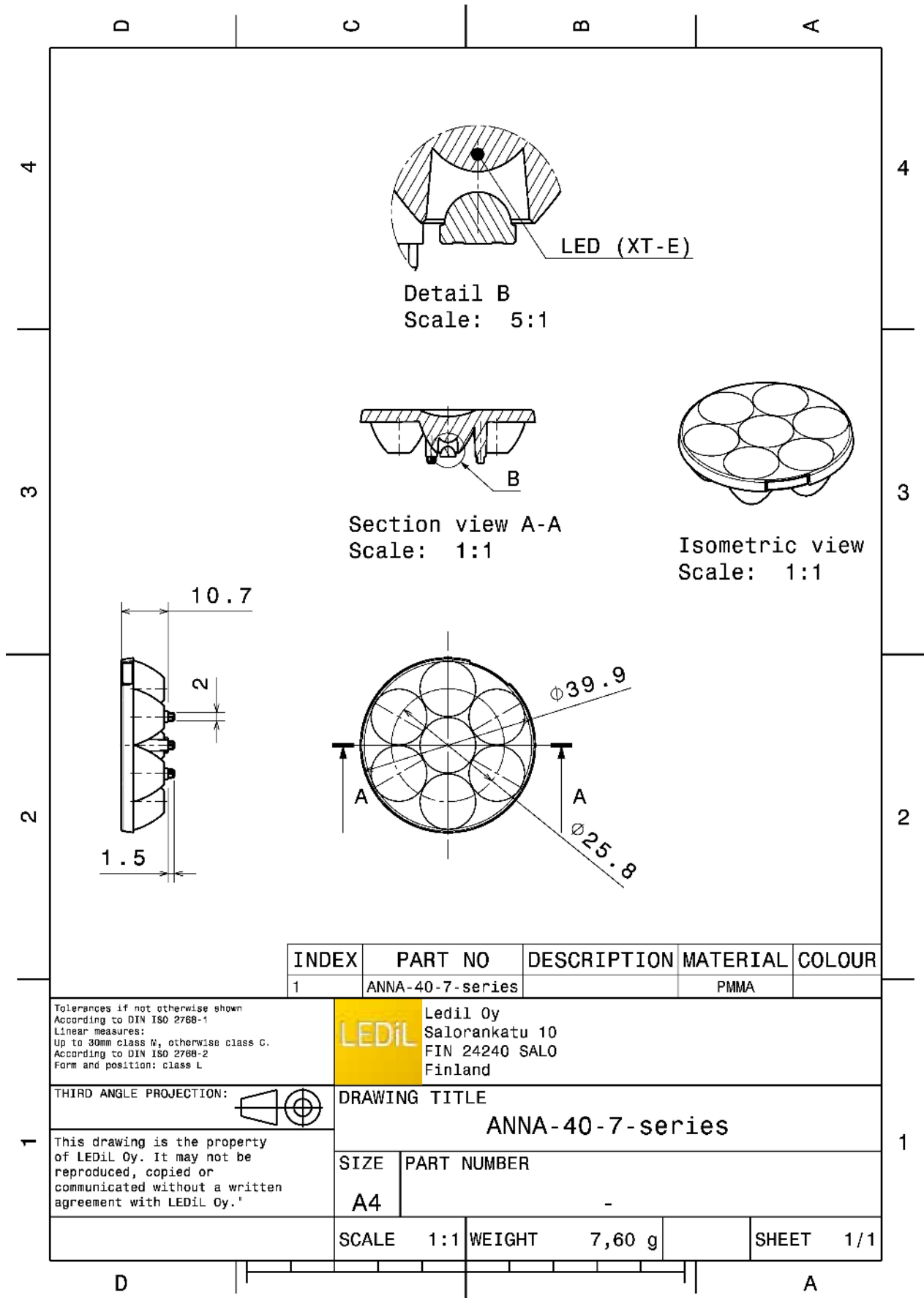

ORDERING INFORMATION:

Component	Qty in box	MOQ	MPQ	Box weight (kg)
C13485_ANNA-40-7-W » Box size: 480 x 280 x 300 mm	760	120	40	7.5

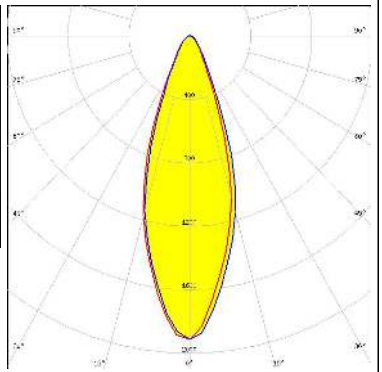

See also our general installation guide: www.ledil.com/installation_guide

OPTICAL RESULTS (MEASURED):

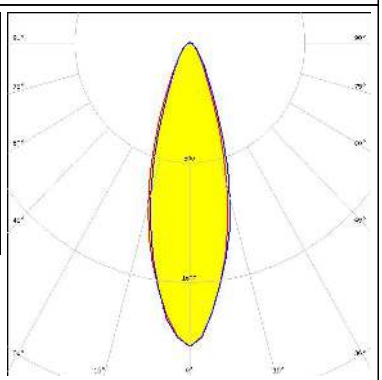
<p>CREE ⇄ LED</p> <p>LED XP-G2 FWHM / FWTM 36.0° / 65.0° Efficiency 88 % Peak intensity 2 cd/lm LEDs/each optic 1 Light colour White Required components:</p>		
<p>CREE ⇄ LED</p> <p>LED XT-E FWHM / FWTM 33.0° / 62.0° Efficiency 86 % Peak intensity 2 cd/lm LEDs/each optic 1 Light colour White Required components:</p>		





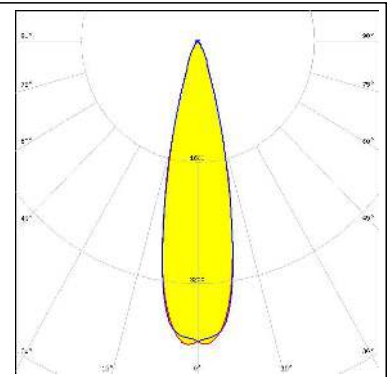
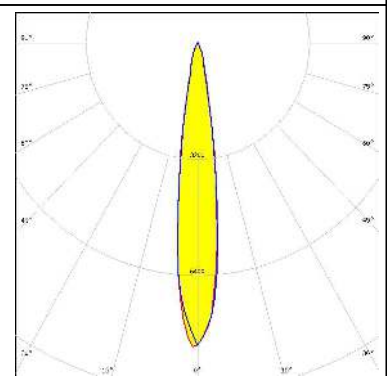
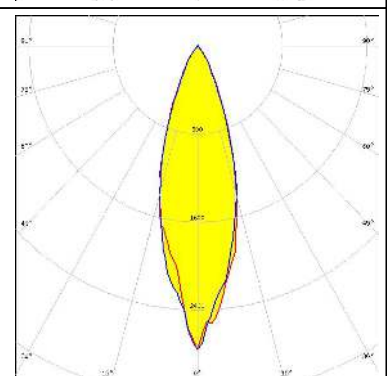
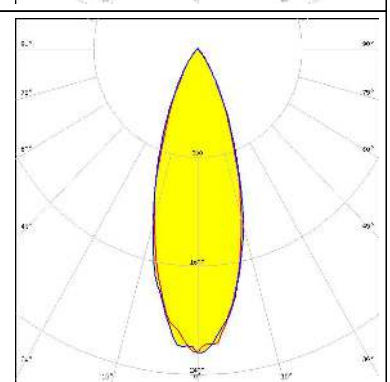

OPTICAL RESULTS (SIMULATED):

<p>CREE ⇄ LED</p> <p>LED J Series 2835 FWHM / FWTM 27.0° / 54.0° Efficiency 96 % Peak intensity 3.2 cd/lm LEDs/each optic 1 Light colour White Required components:</p>	
<p>CREE ⇄ LED</p> <p>LED XB-D FWHM / FWTM 35.4° / 60.9° Efficiency 89 % Peak intensity 2.3 cd/lm LEDs/each optic 1 Light colour White Required components:</p>	
<p>CREE ⇄ LED</p> <p>LED XP-G FWHM / FWTM 42.0° / 67.0° Efficiency 92 % Peak intensity 1.9 cd/lm LEDs/each optic 1 Light colour White Required components:</p>	
<p>CREE ⇄ LED</p> <p>LED XP-L HD FWHM / FWTM 41.0° / 77.0° Efficiency 88 % Peak intensity 1.5 cd/lm LEDs/each optic 1 Light colour White Required components:</p>	

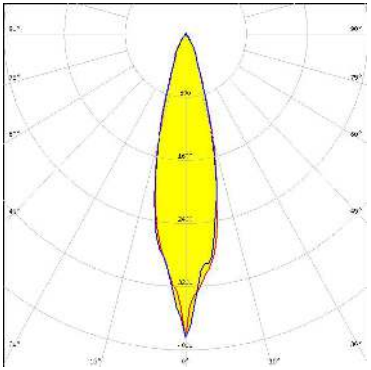
OPTICAL RESULTS (SIMULATED):

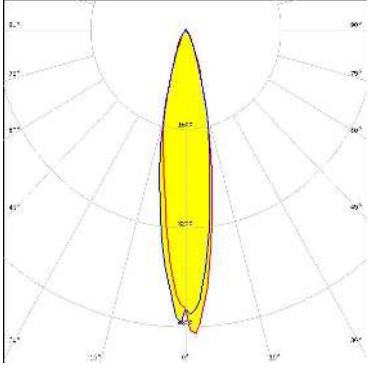
<p>LUMILEDS</p> <p>LED: LUXEON HL1Z FWHM / FWTM: 26.0° / 42.0 + 44.0° Efficiency: 96 % Peak intensity: 4.1 cd/lm LEDs/each optic: 1 Light colour: White Required components:</p>	
<p>LUMILEDS</p> <p>LED: LUXEON PWT FWHM / FWTM: 14.7° / 29.1° Efficiency: 88 % Peak intensity: 8.6 cd/lm LEDs/each optic: 1 Light colour: White Required components:</p>	
<p>LUMILEDS</p> <p>LED: LUXEON T FWHM / FWTM: 30.0° / 58.0° Efficiency: 92 % Peak intensity: 2.9 cd/lm LEDs/each optic: 1 Light colour: White Required components:</p>	
<p>LUMILEDS</p> <p>LED: LUXEON TX FWHM / FWTM: 34.0° / 64.0° Efficiency: 92 % Peak intensity: 2.2 cd/lm LEDs/each optic: 1 Light colour: White Required components:</p>	

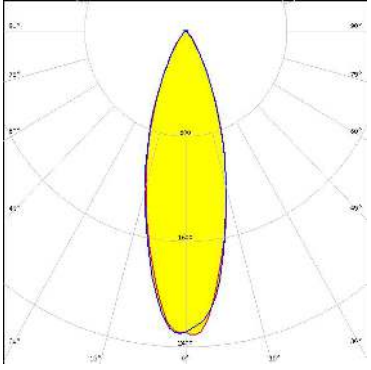
OPTICAL RESULTS (SIMULATED):

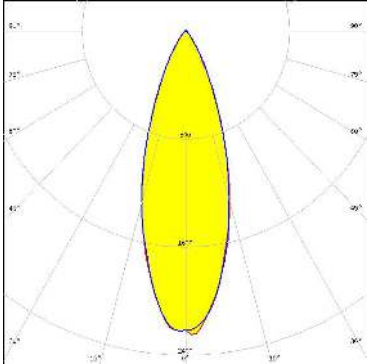
	<p>LED NCSxx19A FWHM / FWTM 24.1° / 47.1° Efficiency 88 % Peak intensity 3.8 cd/lm LEDs/each optic 1 Light colour White Required components:</p>	
	<p>LED NF2x757A FWHM / FWTM 19.5° / 43.6° Efficiency 92 % Peak intensity 5 cd/lm LEDs/each optic 1 Light colour White Required components:</p>	
	<p>LED NVSxx19B/NVSxx19C FWHM / FWTM 32.0° / 63.0° Efficiency 92 % Peak intensity 2.3 cd/lm LEDs/each optic 1 Light colour White Required components:</p>	
	<p>LED OSLOM Square CSSRM2/CSSRM3 FWHM / FWTM 34.0° / 64.0° Efficiency 94 % Peak intensity 2.3 cd/lm LEDs/each optic 1 Light colour White Required components:</p>	

OPTICAL RESULTS (SIMULATED):

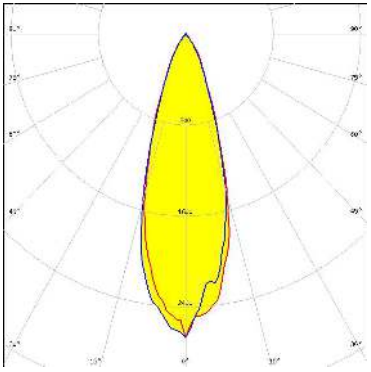
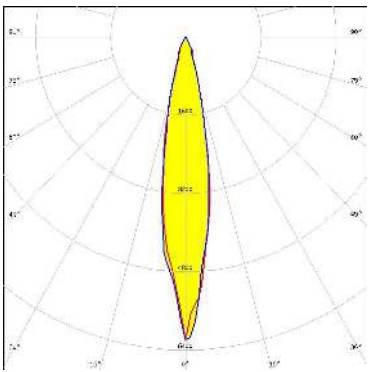
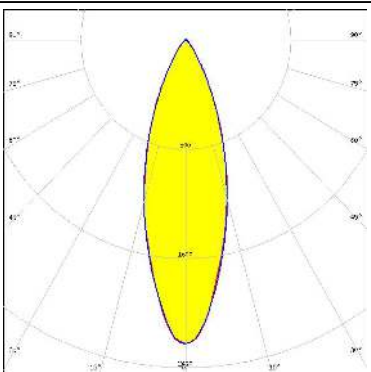
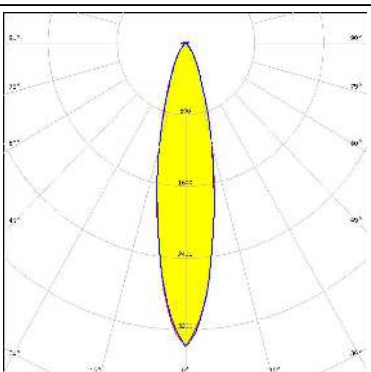
<p>OSRAM Opto Semiconductors</p> <p>LED: OSLON Square EC</p> <p>FWHM / FWTM: 31.5° / 59.2°</p> <p>Efficiency: 91 %</p> <p>Peak intensity: 2.8 cd/lm</p> <p>LEDs/each optic: 1</p> <p>Light colour: White</p> <p>Required components:</p>	
<p>OSRAM Opto Semiconductors</p> <p>LED: SFH 4715S</p> <p>FWHM / FWTM: 18.0° / 36.0°</p> <p>Efficiency: 89 %</p> <p>Peak intensity: 6.6 cd/lm</p> <p>LEDs/each optic: 1</p> <p>Light colour: White</p> <p>Required components:</p>	
<p>SAMSUNG</p> <p>LED: LH351B</p> <p>FWHM / FWTM: 32.0° / 64.0°</p> <p>Efficiency: 95 %</p> <p>Peak intensity: 2.2 cd/lm</p> <p>LEDs/each optic: 1</p> <p>Light colour: White</p> <p>Required components:</p>	
<p>SEMI SEOUL SEMICONDUCTOR</p> <p>LED: Z8Y22</p> <p>FWHM / FWTM: 22.0° / 52.0°</p> <p>Efficiency: 94 %</p> <p>Peak intensity: 3.4 cd/lm</p> <p>LEDs/each optic: 1</p> <p>Light colour: White</p> <p>Required components:</p>	

OPTICAL RESULTS (SIMULATED):

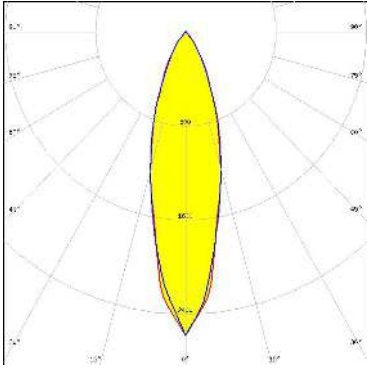
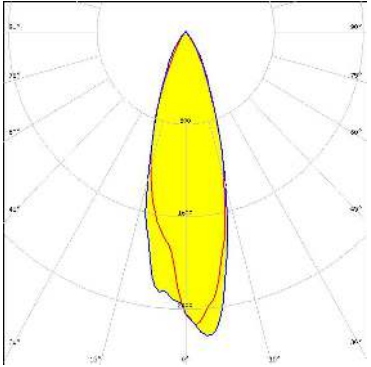
 SEOUL SEMICONDUCTOR		
LED	Z8Y22P	
FWHM / FWTM	28.0°	
Efficiency	91 %	
Peak intensity	2.6 cd/lm	
LEDs/each optic	1	
Light colour	White	
Required components:		
SHARP		
LED	Double Dome (GM2BB)	
FWHM / FWTM	28.9° / 59.3°	
Efficiency	89 %	
Peak intensity	2.7 cd/lm	
LEDs/each optic	1	
Light colour	White	
Required components:		

GENERAL INFORMATION:

NOTE: The typical beam angle will be changed by different color, chip size and chip position tolerance. The typical total beam angle is the full angle measured where the luminous intensity is half of the peak value.

MATERIALS:

As part of our continuous research and improvement processes, and to ensure the best possible quality and availability of our products, LEDiL reserves the right to change material grades without notice.

PRODUCT DATA USER AGREEMENT AND DISCLAIMER:

The measured data in the provided downloadable LEDiL Product Datasheets and Mechanical 2D-Drawings is rounded and provided as reference for planning. LEDiL Oy's optical specifications have been verified by conducting performance testing of the products in accordance with the company's quality system. The reported data are averaged results of multiple measurements with typical variation. LEDiL Oy reserves the right to without prior notification make changes and improvements to its products.

LEDiL Oy assumes neither warranty, nor guarantee nor any other liability of any kind for the contents and correctness of the provided data. The provided data has been generated with highest diligence but the provided data may in reality not represent the complete possible variation range of all intrinsic parameters. Therefore, in certain cases a deviation from the provided data could occur.

LEDiL Oy reserves the right to undertake technical changes of its products without further notification which could lead to changes in the provided data. LEDiL Oy assumes no liability of any kind for the possible deviation from any provided data or any other damage resulting from the usage of the provided data.

The user agrees to this disclaimer and user agreement with the download or usage of the provided files.

LEDiL Oy

Joensuunkatu 13
FI-24240 SALO
Finland

LEDiL Inc.

228 West Page Street
Suite D
Sycamore IL 60178
USA

Ledil Optics Technology (Shenzhen) Co., Ltd.

405 , Block B
Casic Motor Building
Shenzhen 518057
P.R.CHINA

Local sales and technical support

[www.ledil.com/
where_to_buy](http://www.ledil.com/where_to_buy)

Shipping locations

Salo, Finland
Hong Kong, China

Distribution Partners

[www.ledil.com/
where_to_buy](http://www.ledil.com/where_to_buy)