



The Future of Analog IC Technology®

EVM3632S-PQ-00A

High-Frequency 18V/3A DC/DC Regulator with Integrated Inductor Evaluation Board

DESCRIPTION

EVM3632S-PQ-00A evaluation board is based on MPS'S MPM3632S. The MPM3632S is a synchronous rectified, step-down Mini-Module regulator with built-in power MOSFETs, inductor and two capacitors. It offers a very compact solution with only input and output capacitors to achieve a 3A continuous output current with excellent load and line regulation over a wide input supply range. The MPM3632S operates in fixed 2.2MHz switching frequency with Constant-On-Time control which provides fast load transient response.

Full protection features include output over voltage protection, over-current protection and thermal shut down.

MPM3632S eliminates design and manufacturing risks while dramatically improving time to market.

The MPM3632S is available in a space-saving LGA10 (3mmx3mmx1.45mm) package..

ELECTRICAL SPECIFICATION (1)

Parameter	Symbol	Value	Units
Input Voltage	V _{IN}	12	V
Output Voltage	V _{OUT}	3.3	V
Output Current	I _{OUT}	3	A

Notes:

1) For different Input/output voltage specs and different output capacitor/inductor may need change the application circuit parameters.

FEATURES

- Complete Switch Mode Power Supply
- Wide 4V-to-18V Operation Input Range
- 36mΩ/18mΩ Low R_{DS(ON)} Internal Power MOSFETs
- 0.5% Accuracy Output Voltage
- 3A Continuous Output Current
- 2.2MHz Switching Frequency
- Forced CCM Mode
- Power Good Indicator
- 500µA Low Quiescent Current
- Hiccup OCP Protection
- Programmable Soft Start (Metal option)
- Output Over Voltage Protection
- Fast Transient Response
- Available in LGA3x3x1.45mm Package

APPLICATIONS

- Server Systems
- Medical and Imaging Equipment
- Distributed Power Systems

All MPS parts are lead-free, halogen free, and adhere to the RoHS directive. For MPS green status, please visit MPS website under Quality Assurance.

"MPS" and "The Future of Analog IC Technology" are Registered Trademarks of Monolithic Power Systems, Inc.

EVM3632S-PQ-00A EVALUATION BOARD



(L x W x H) 63.7mm x 63.7mm x 6.4mm

Board Number	MPS IC Number
EVM3632S-PQ-00A	MPM3632SGPQ

Efficiency

V_{IN}=12V, V_{OUT}=3.3V

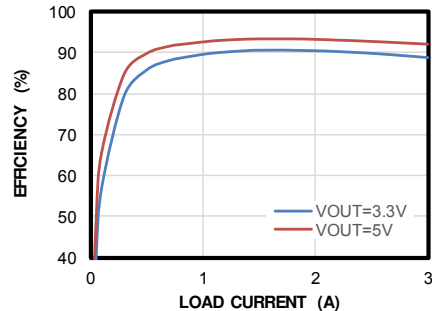

EVALUATION BOARD SCHEMATIC

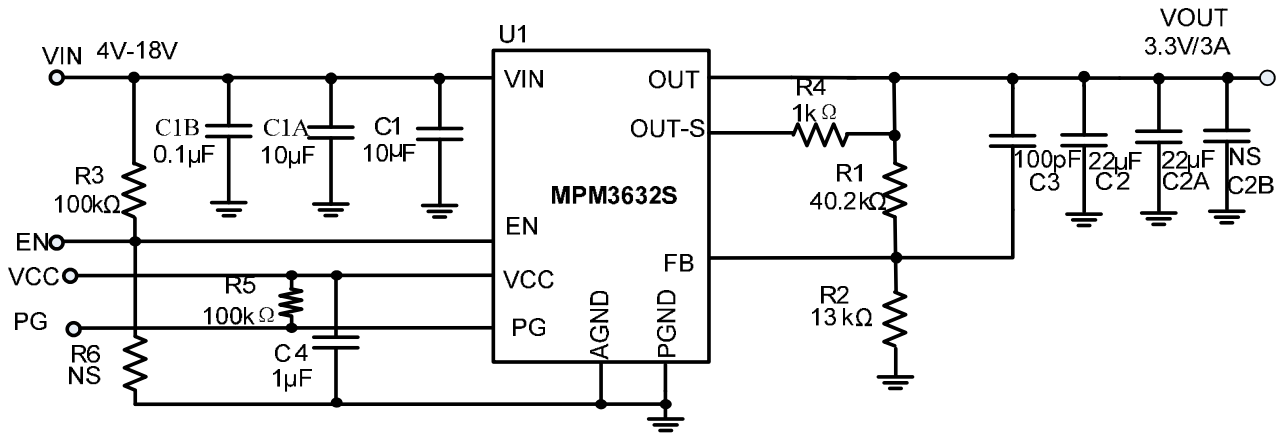

EVM3632S-PQ-00A BILL OF MATERIALS

Qty	RefDes	Value	Description	Package	Manufacturer	Manufacturer_P/N
2	C1,C1A	10μF	Ceramic Cap,25V,X5R	0805	muRata	GRM21BR61E106KA73L
2	C2,C2A	22μF	Ceramic Cap,16V,X5R	0805	muRata	RM21BR61C226ME44L
1	C3	100pF	Ceramic Cap,16V,X5R	0402	muRata	GRM1555C1E101JA01D
1	C1B	0.1μF	Ceramic Cap,25V,X7R	0402	muRata	GRM188R71E104KA01D
1	C4	1μF	Ceramic Cap.,16V,X6S	0402	muRata	GRM155C81C105KE11D
0	C2B	NS	NS	NS	NS	NS
1	R1	40.2kΩ	Film Res,1%,0402,40K2	0402	Yageo	RC0402FR-0740K2L
1	R2	13kΩ	Film Res,1%,0402,13K	0402	Yageo	RC0402FR-0713KL
2	R3,R5	100kΩ	Thick Film Res., 1%	0402	Yageo	RC0402FR-07100KL
1	R4	1kΩ	Thick Film Res., 1%	0402	Yageo	RC0402FR-071KL
0	R6	NS	NS	NS	NS	NS
1	U1	MPM3632S	Synchronous Step-Down Convert	NS	MPS	MPM3632SGPQ

EVB TEST RESULTS

$V_{IN} = 12V$, $V_{OUT} = 3.3V$, $T_A = +25^\circ C$, unless otherwise noted.

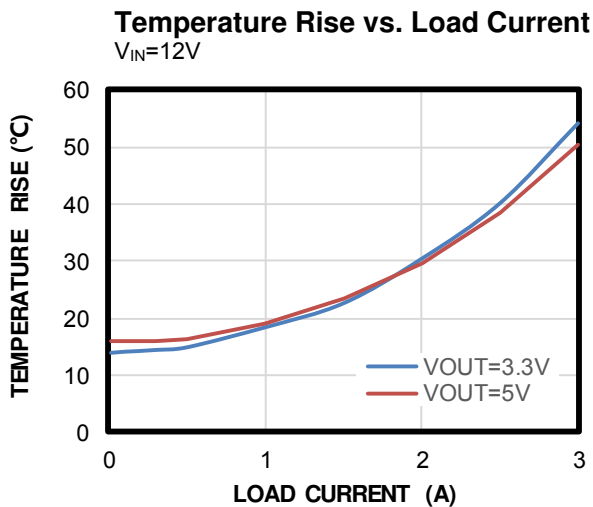
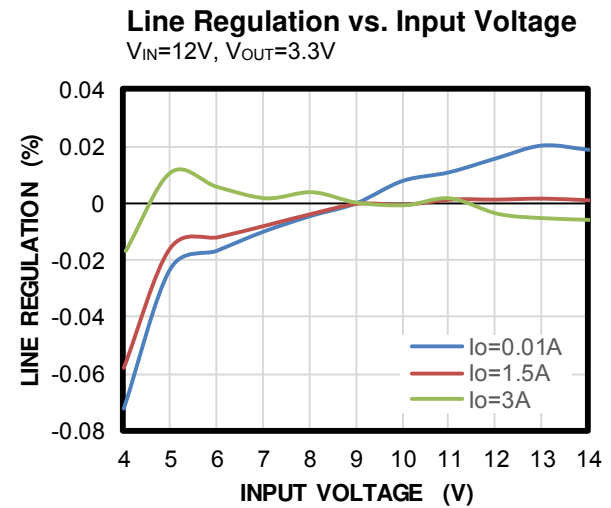
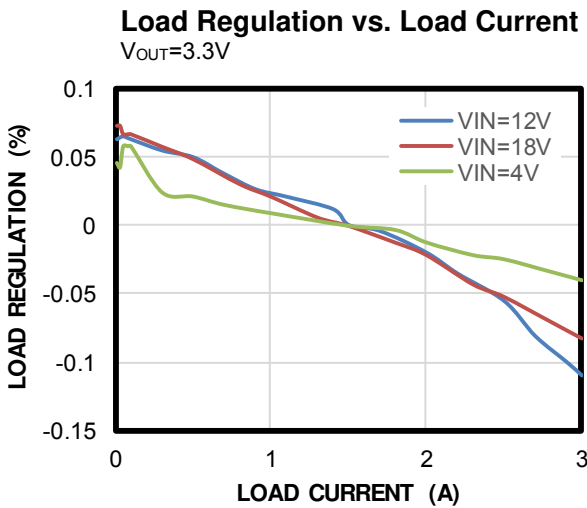
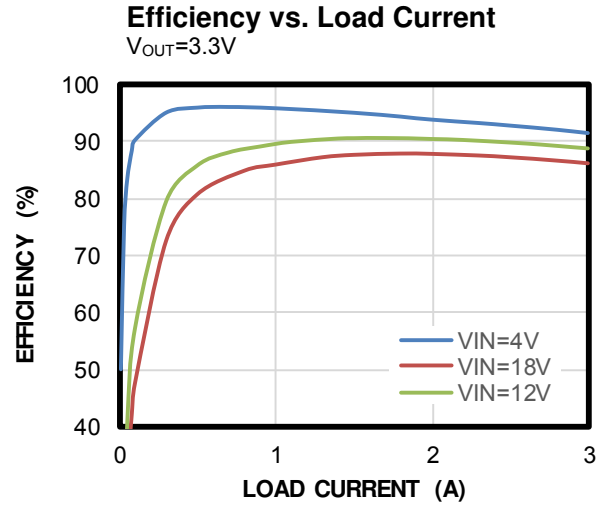
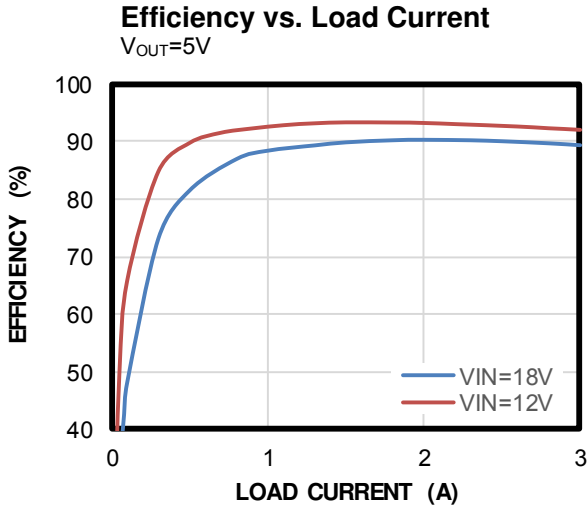

EVB TEST RESULTS (continued)

$V_{IN} = 12V$, $V_{OUT} = 3.3V$, $T_A = +25^{\circ}C$, unless otherwise noted.

Vo Ripple
 $I_{OUT} = 0A$

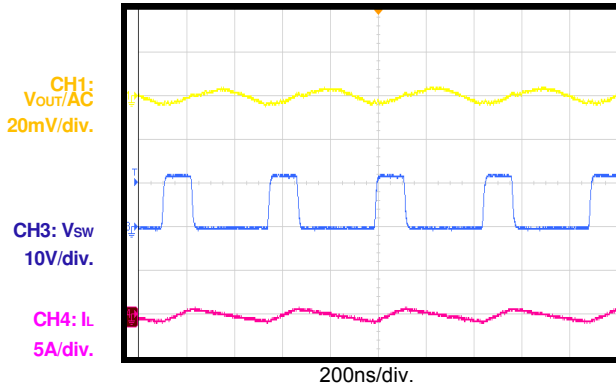

Vo Ripple
 $I_{OUT} = 3A$

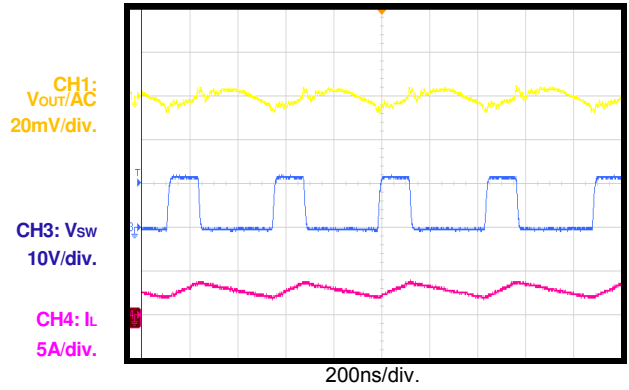

VIN Start-Up Through Input Voltage
 $I_{OUT} = 0A$

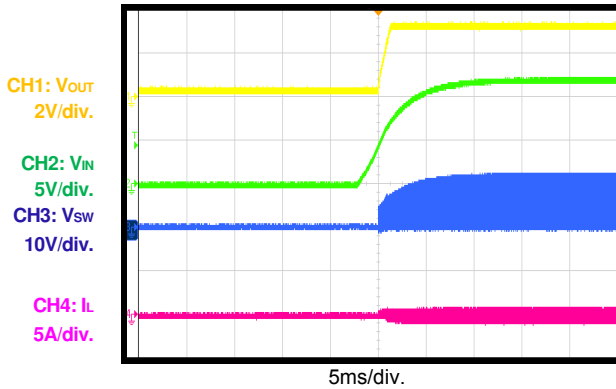

VIN Start-Up Through Input Voltage
 $I_{OUT} = 3A$

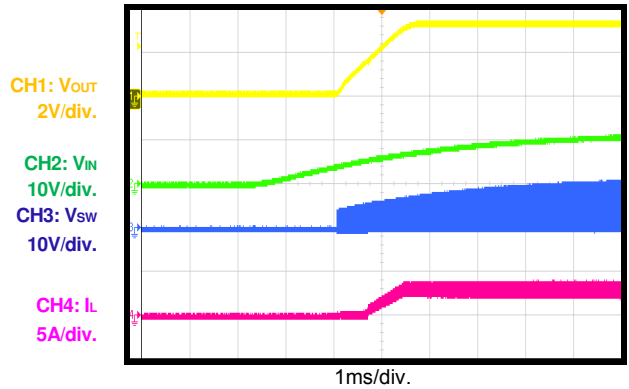

Shutdown Through Input Voltage
 $I_{OUT} = 0A$

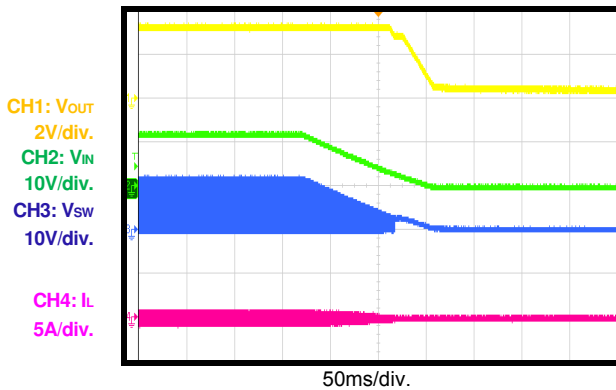

Shutdown Through Input Voltage
 $I_{OUT} = 3A$

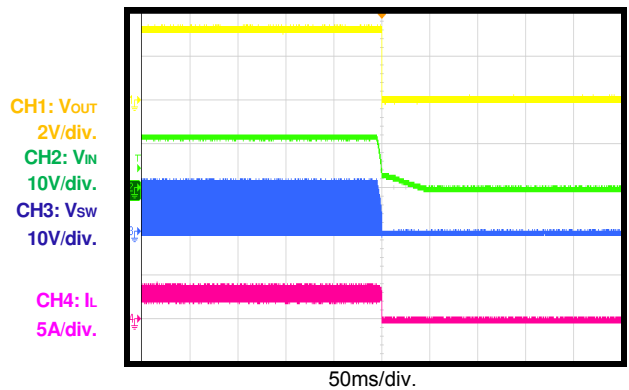

EVB TEST RESULTS (continued)

$V_{IN} = 12V$, $V_{OUT} = 3.3V$, $T_A = +25^{\circ}C$, unless otherwise noted.

Start-Up Through Enable

$I_{OUT} = 0A$

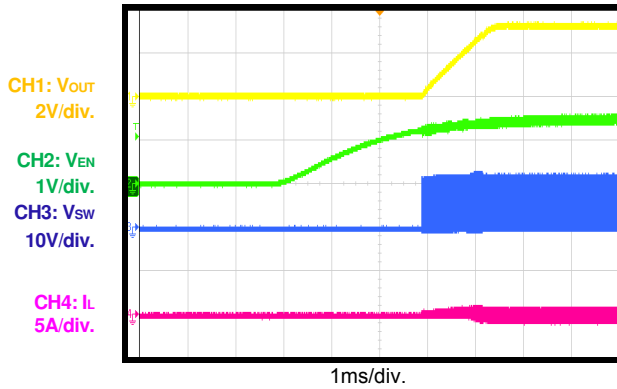

Start-Up Through Enable

$I_{OUT} = 3A$

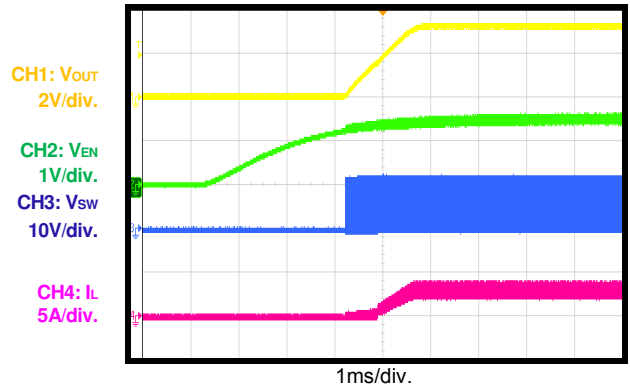

Shutdown Through Enable

$I_{OUT} = 0A$

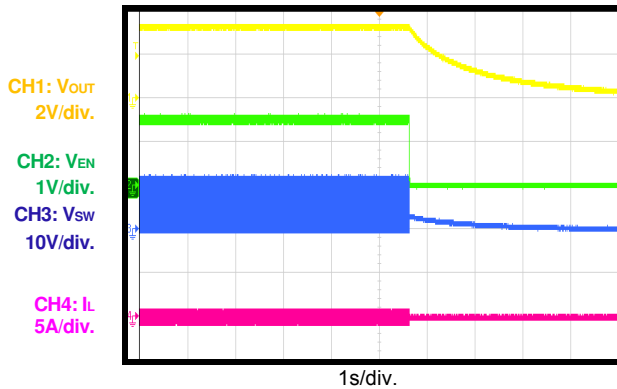

Shutdown Through Enable

$I_{OUT} = 3A$

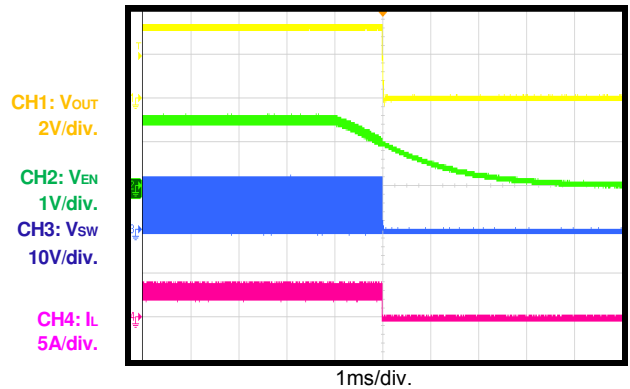

Short Circuit Entry

$I_{OUT} = 0A$

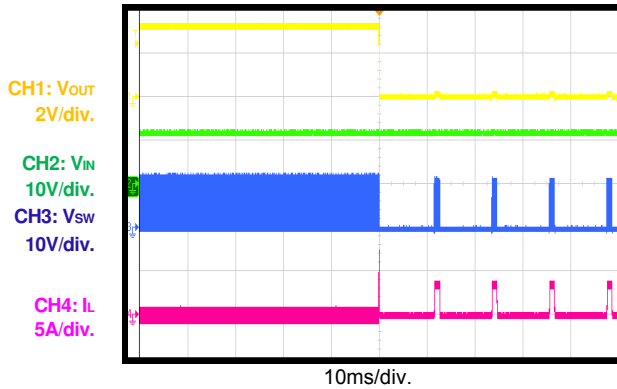

Short Circuit Entry

$I_{OUT} = 3A$

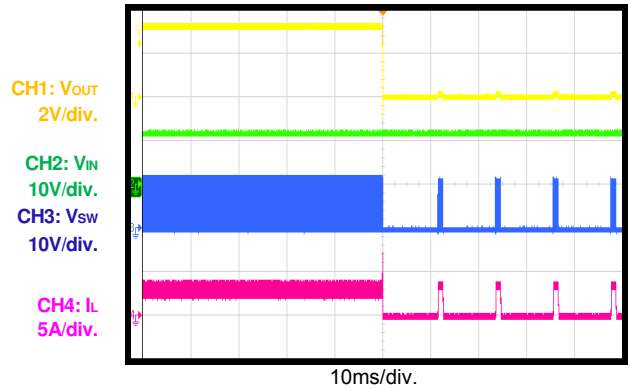

EVB TEST RESULTS *(continued)*

$V_{IN} = 12V$, $V_{OUT} = 3.3V$, $T_A = +25^{\circ}C$, unless otherwise noted.

Short Circuit Recovery

$I_{OUT} = 0A$

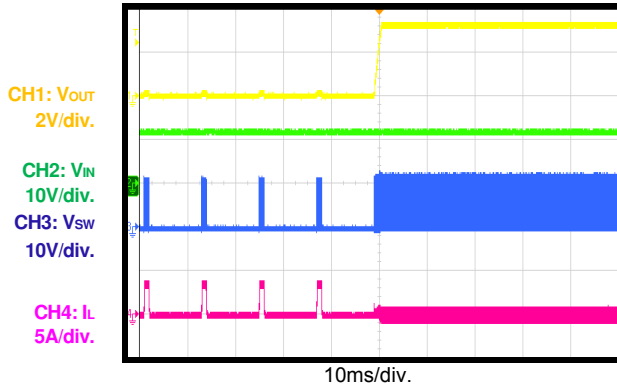

Short Circuit Recovery

$I_{OUT} = 3A$

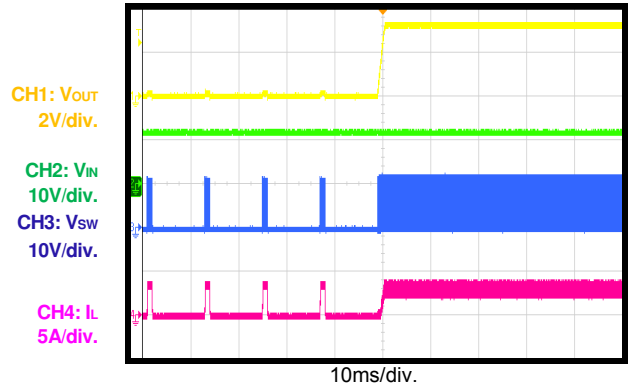

Short Circuit Steady State

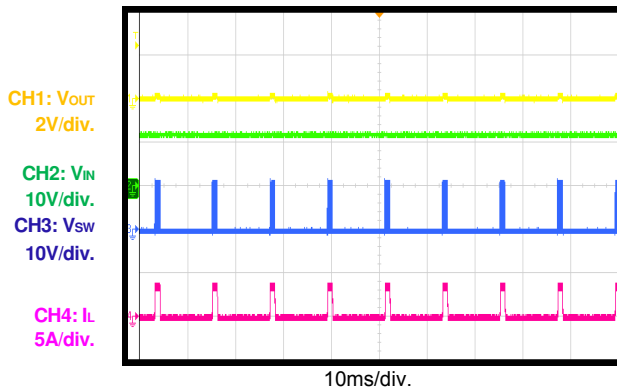

Transient Response

$I_{OUT} = 1.5A-3A$, $800mA/\mu s$

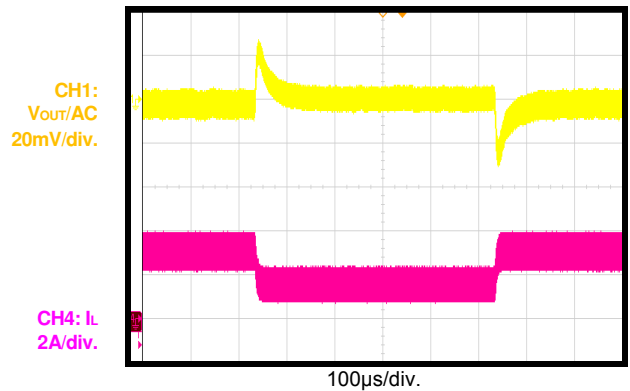

PRINTED CIRCUIT BOARD LAYOUT

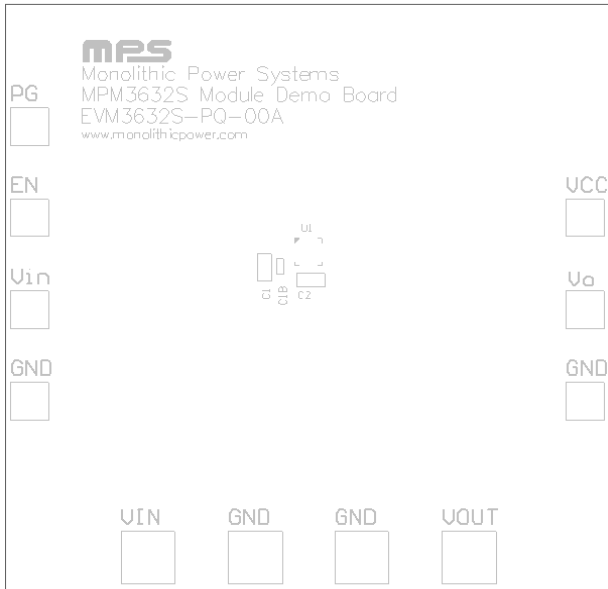

Figure1: Top Silk Layer

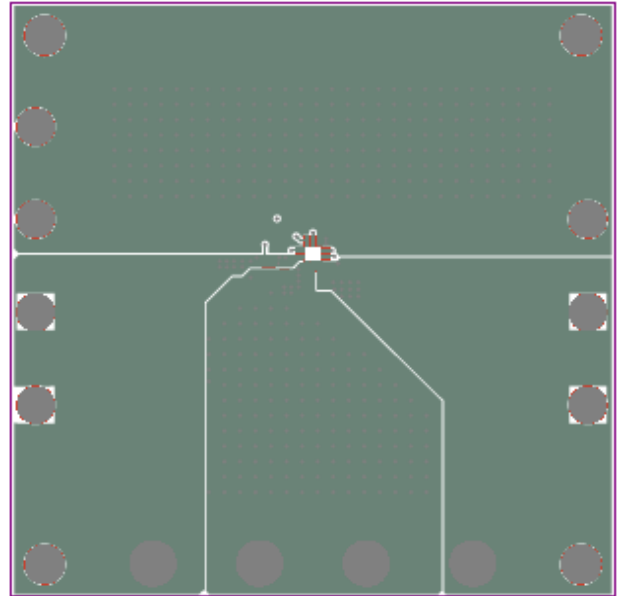

Figure2: Top Layer

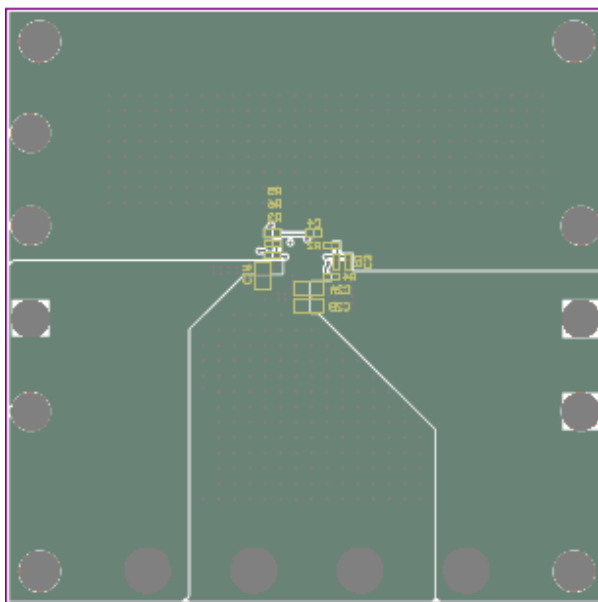

Figure3: Bottom Layer

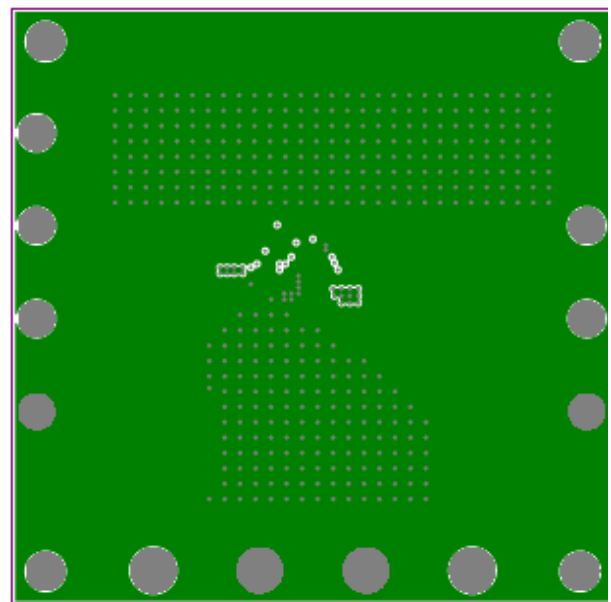

Figure4:Inner1 Layer

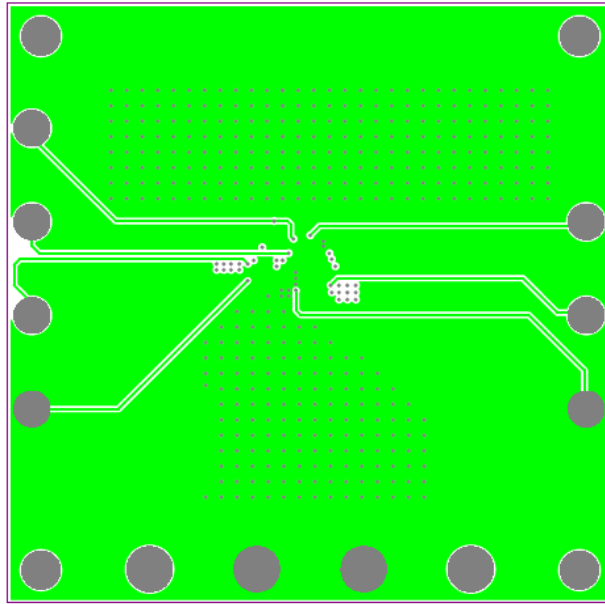

Figure5:Inner2 Layer

QUICK START GUIDE

1. Preset Power Supply to 12V.
2. Turn Power Supply off.
3. Connect Power Supply terminals to:
 - a. Positive (+): VIN
 - b. Negative (-): GND
4. Connect Load to:
 - a. Positive (+): VOUT
 - b. Negative (-): GND
5. Turn Power Supply on after making connections. The board will automatically start up.
6. To use the Enable function, apply a digital input to the EN pin. Drive EN higher than 1.2V to turn on the regulator, or less than 1V to turn it off.

NOTICE: The information in this document is subject to change without notice. Please contact MPS for current specifications. Users should warrant and guarantee that third party Intellectual Property rights are not infringed upon when integrating MPS products into any application. MPS will not assume any legal responsibility for any said applications.