



[Dynamic Series](#) | [Dynamic 1000 Series](#)

TE Internal #: 1903118-2

Connector Contact, Tab, Component-to-Wire, 22 – 18 AWG Wire Size, .34 – .86 mm² Wire Size, Gold, Bag & Box, Wire & Cable, 5 A, Dynamic 1000 Series

[View on TE.com >](#)

[Connectors >](#) [PCB Connectors >](#) [Wire-to-Board Connectors >](#) [Wire-to-Board Connector Contacts >](#)

Contact: Component To Wire; 3-5A, 30-18 Wire Size



Contact Type: **Tab**

Connector System: **Component-to-Wire**

Wire Size: **.34 – .86 mm²**

Contact Mating Area Plating Material: **Gold**

All Contact: Component To Wire; 3-5A, 30-18 Wire Size (30)

Features

Product Type Features

Connector System	Component-to-Wire
Connector & Contact Terminates To	Wire & Cable

Contact Features

Mating Tab Width	.7 mm[.027 in]
Mating Tab Thickness	.5 mm[.02 in]
Contact Type	Tab
Contact Mating Area Plating Material	Gold
Contact Current Rating (Max)	5 A

Dimensions

Wire Size	.34 – .86 mm ²
-----------	---------------------------

Usage Conditions

Operating Temperature Range	-55 – 105 °C[-67 – 221 °F]
-----------------------------	----------------------------



Operation/Application

Circuit Application	Signal
---------------------	--------

Packaging Features

Packaging Method	Bag & Box
------------------	-----------

Product Compliance

[For compliance documentation, visit the product page on TE.com>](#)

EU RoHS Directive 2011/65/EU	Compliant
EU ELV Directive 2000/53/EC	Compliant
China RoHS 2 Directive MIIT Order No 32, 2016	No Restricted Materials Above Threshold
EU REACH Regulation (EC) No. 1907/2006	Current ECHA Candidate List: JUNE 2023 (235) Candidate List Declared Against: JAN 2023 (233) Does not contain REACH SVHC
Halogen Content	Low Halogen - Br, Cl, F, I < 900 ppm per homogenous material. Also BFR/CFR/PVC Free
Solder Process Capability	Not applicable for solder process capability

Product Compliance Disclaimer

This information is provided based on reasonable inquiry of our suppliers and represents our current actual knowledge based on the information they provided. This information is subject to change. The part numbers that TE has identified as EU RoHS compliant have a maximum concentration of 0.1% by weight in homogenous materials for lead, hexavalent chromium, mercury, PBB, PBDE, DBP, BBP, DEHP, DIBP, and 0.01% for cadmium, or qualify for an exemption to these limits as defined in the Annexes of Directive 2011/65/EU (RoHS2). Finished electrical and electronic equipment products will be CE marked as required by Directive 2011/65/EU. Components may not be CE marked. Additionally, the part numbers that TE has identified as EU ELV compliant have a maximum concentration of 0.1% by weight in homogenous materials for lead, hexavalent chromium, and mercury, and 0.01% for cadmium, or qualify for an exemption to these limits as defined in the Annexes of Directive 2000/53/EC (ELV). Regarding the REACH Regulation, the information TE provides on SVHC in articles for this part number is based on the latest European Chemicals Agency (ECHA) 'Guidance on requirements for substances in articles' posted at this URL: <https://echa.europa.eu/guidance-documents/guidance-on-reach>

Compatible Parts

TE Part # CAT-D9934-A15
Contact: Component To Wire; 3-5A, 30-18 Wire Size

TE Part # 1-1903131-0
DYNAMIC 1200D TAB HSG 20P P/M

TE Part # 2119142-1
CCII D1000 2L REC TAB 22-18 ASSY

TE Part # 1891526-1
EXTRACTION TOOL FOR DYNAMIC 1000 SERIES



Also in the Series | Dynamic 1000 Series

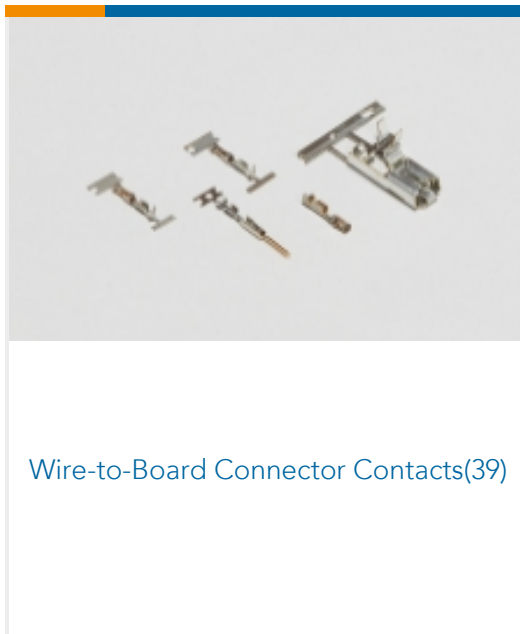
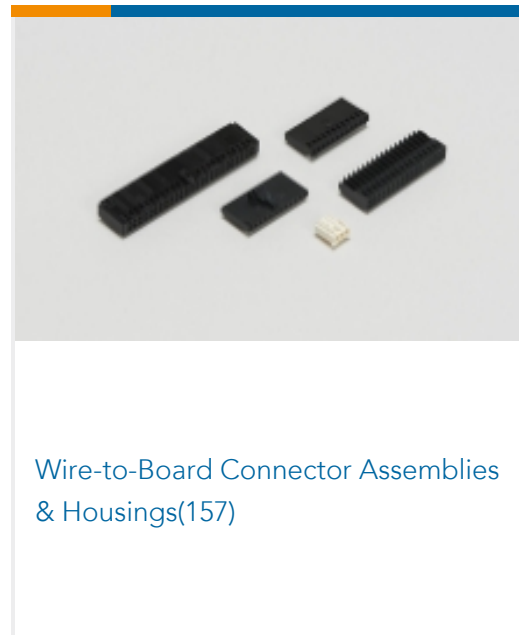
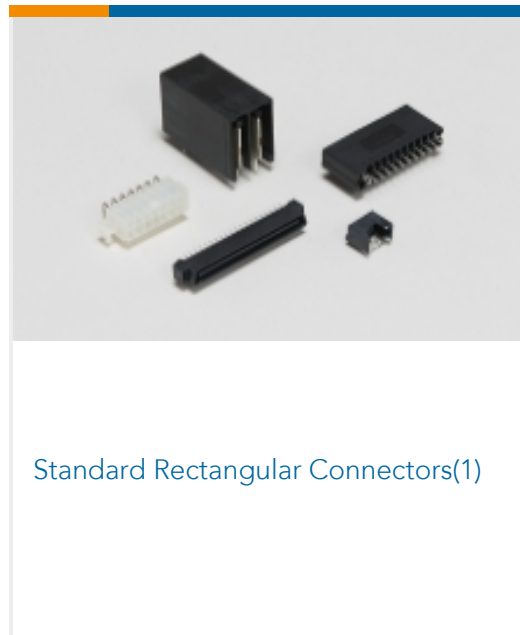
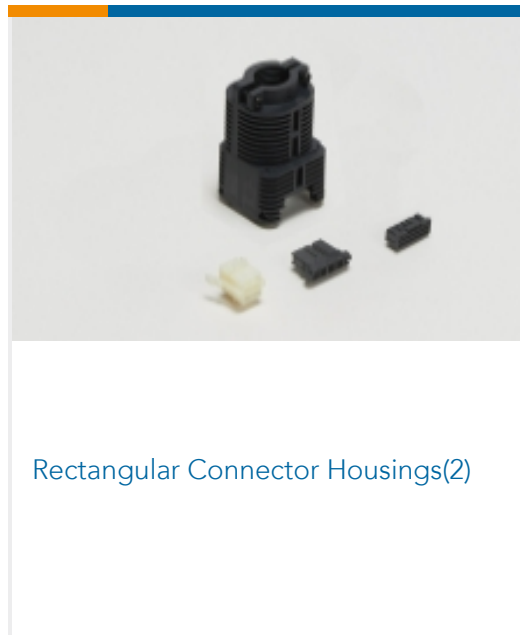
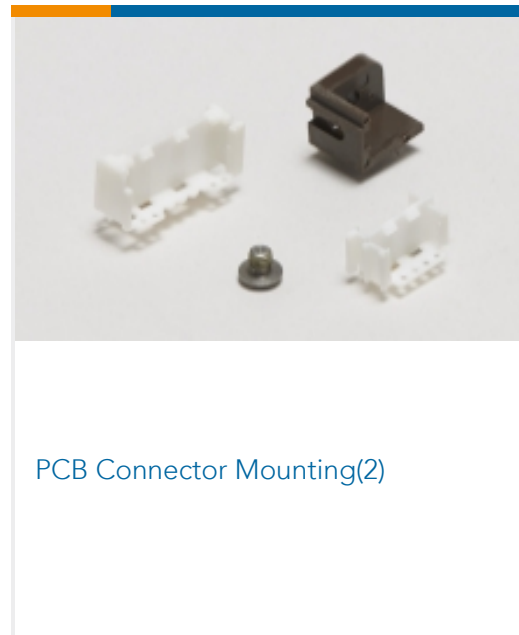
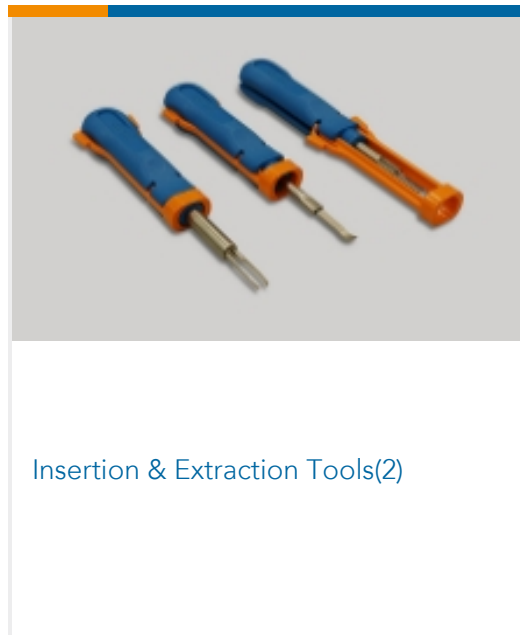
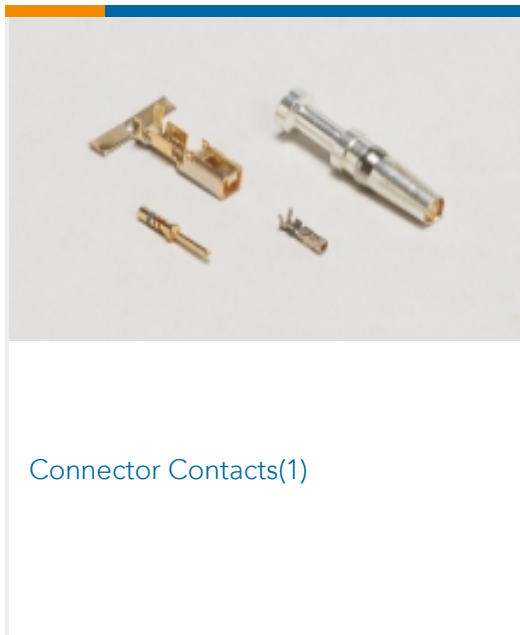

Customers Also Bought



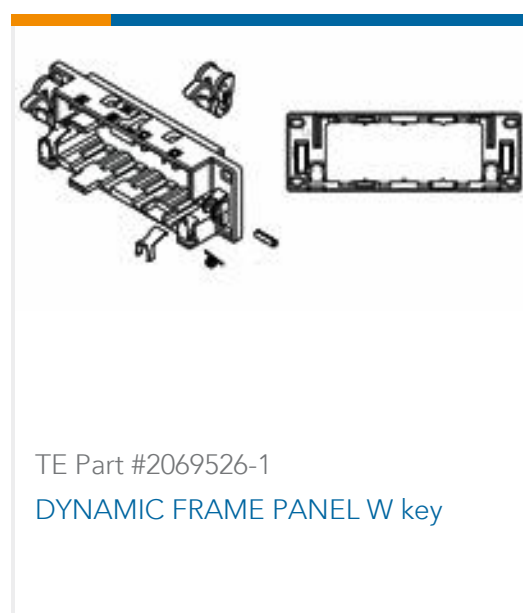

Documents

Product Drawings

[DYNAMIC D1000 TAB CONT AU 0.38um 2L L/P](#)

English

CAD Files

Customer View Model

[ENG_CVM_CVM_1903118-2_B.3d_igs.zip](#)

English

Customer View Model

[ENG_CVM_CVM_1903118-2_B.2d_dxf.zip](#)

English

3D PDF

3D

Customer View Model

[ENG_CVM_CVM_1903118-2_B.3d_stp.zip](#)

English

By downloading the CAD file I accept and agree to the [Terms and Conditions](#) of use.

Datasheets & Catalog Pages

[1-1773732-4_DYNAMIC_SERIES_CATALOG_ENGLISH](#)

Japanese

[1-1773732-4_DYNAMIC_SERIES_CATALOG_ENGLISH](#)

English

Product Specifications

[Application Specification](#)

English

Product Environmental Compliance

[Product Compliance Document](#)

English

[Product Compliance Document](#)

English

Instruction Sheets

[Instruction Sheet \(non U.S.\)](#)



Japanese

[Instruction Sheet \(non U.S.\)](#)

English

[MULTIPLE ENCLOSURE 67M D1200 15POS. TAB PLUG](#)

Japanese

[Instruction Sheet \(non U.S.\)](#)

Japanese

[Instruction Sheet \(non U.S.\)](#)

Japanese

[Agency Approvals](#)

[TUV Certificate](#)

English