

LUMOTAST FK

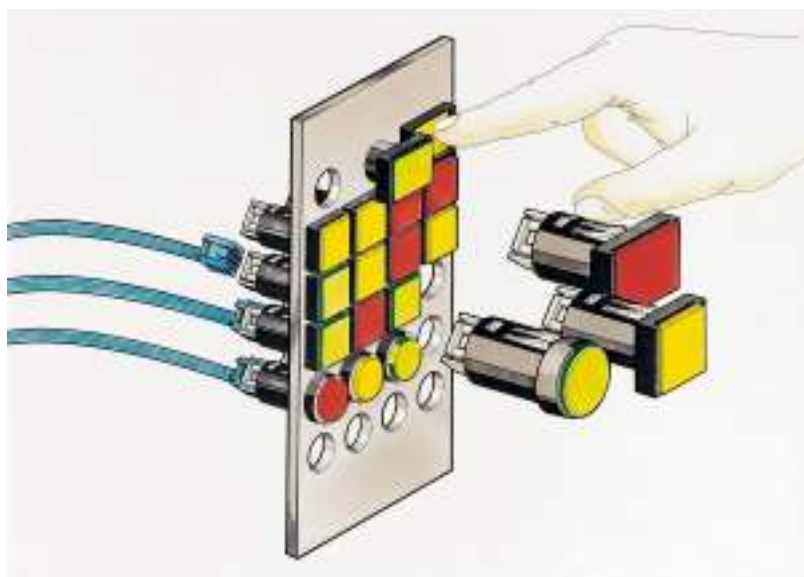

1

LUMO
FK

General data

LUMOTAST FK illuminated pushbutton range

- Illuminable pushbuttons and signal lamps with lamp socket T 1/T 1¹/₄. Please order lamps / LEDs separately.
- Mounting hole diameter 16.2 mm
- 42 V/100 mA max.
- Water-jet proof IP65
- Low profile
- Keyed socket connector and flat ribbon cable in insulation displacement (IDC) technology or PCB plug-in socket
- Time-saving click fixing method: Insert pushbutton into front panel and press pushbutton once to fix it.

Content

LUMOTAST FK illuminated pushbutton, 42 V/100 mA

LUMOTAST FK illuminated pushbutton, square collar, 42 V/100 mA	1 - 12
LUMOTAST FK illuminated pushbutton, round collar, 42 V/100 mA	1 - 13
LUMOTAST FK illuminated pushbutton, rectangular collar, 42 V/100 mA	1 - 14

LUMOTAST FK signal lamp

LUMOTAST FK signal lamp, square collar	1 - 16
LUMOTAST FK signal lamp, round collar	1 - 17
LUMOTAST FK signal lamp, rectangular collar	1 - 18

Series LUMOTAST FK

16.2 mm mounting hole diameter

1

Design

LUMO
FK

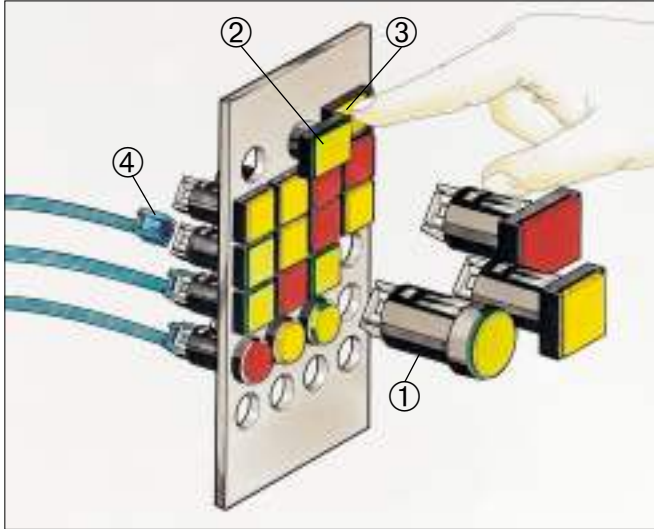

- ① Pushbutton as supplied
- ② Insert pushbutton into panel cut-out
- ③ Press once to fit
- ④ Attach connector with flat-ribbon cable

Disassembly

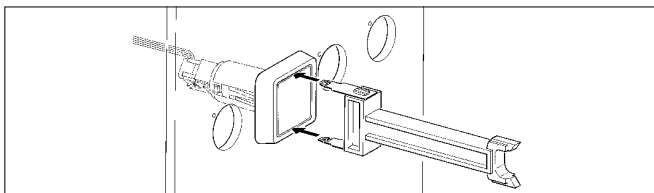

1. Grip body/lens

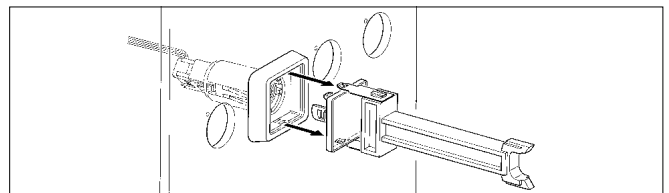

2. Pull out body/lens

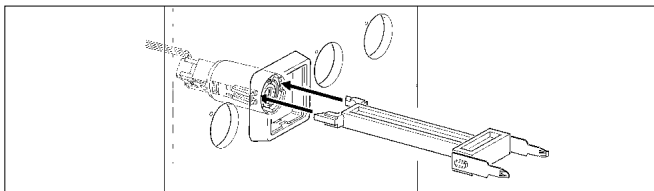

3. Release click lever

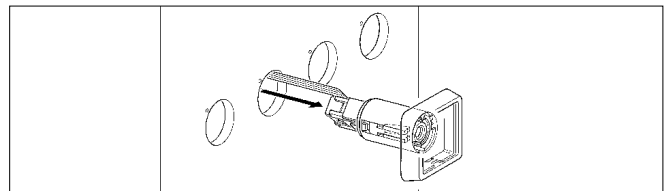

4. Pull out pushbutton/signal lamp with cable

LUMOTAST FK

Dimensional drawing

With quick connector and flat-ribbon cable

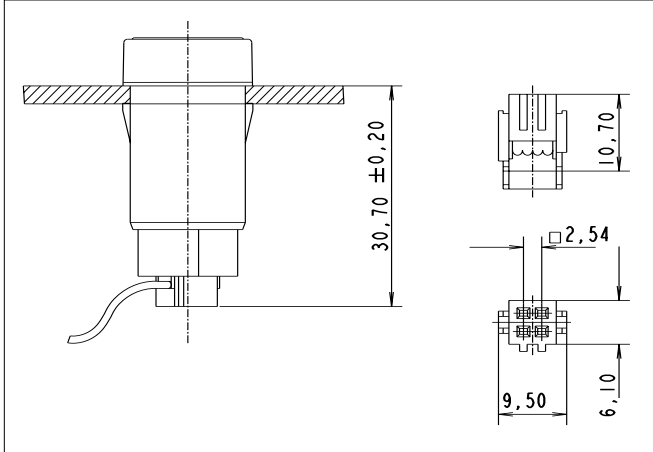

Connection diagram (PCB top view)

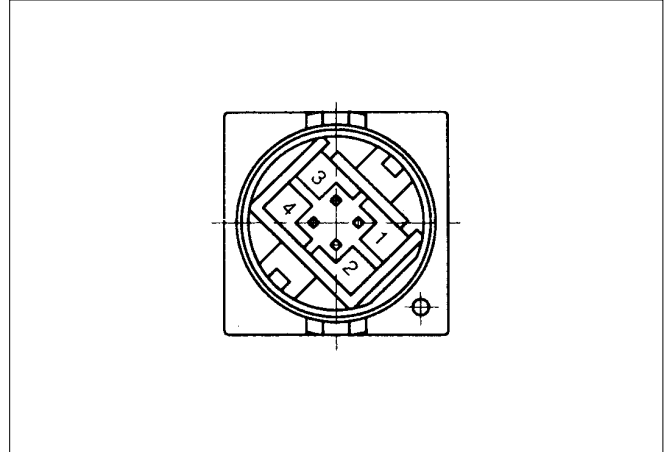

1 + 4 = pushbutton connection, 2 + 3 = lamp connection

With plug-in socket

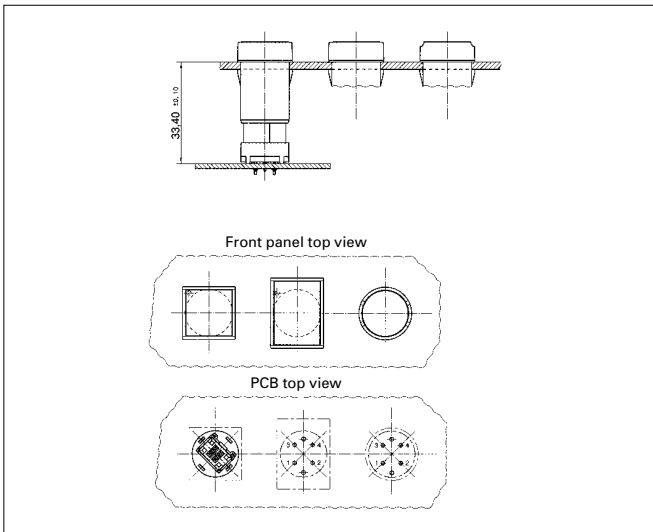

Plug-in socket for PCB

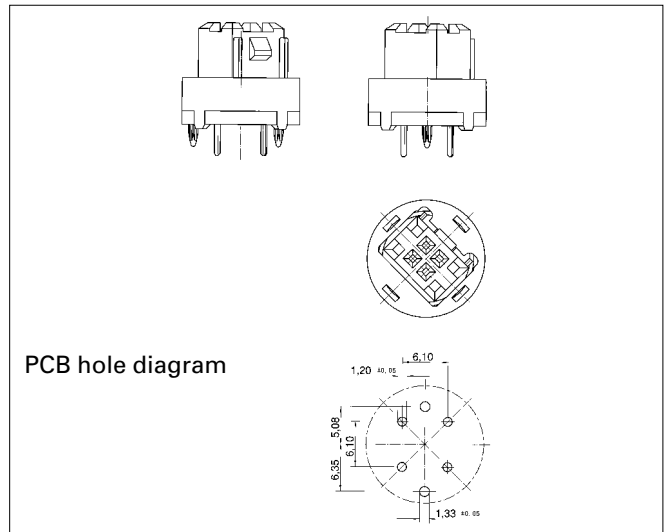

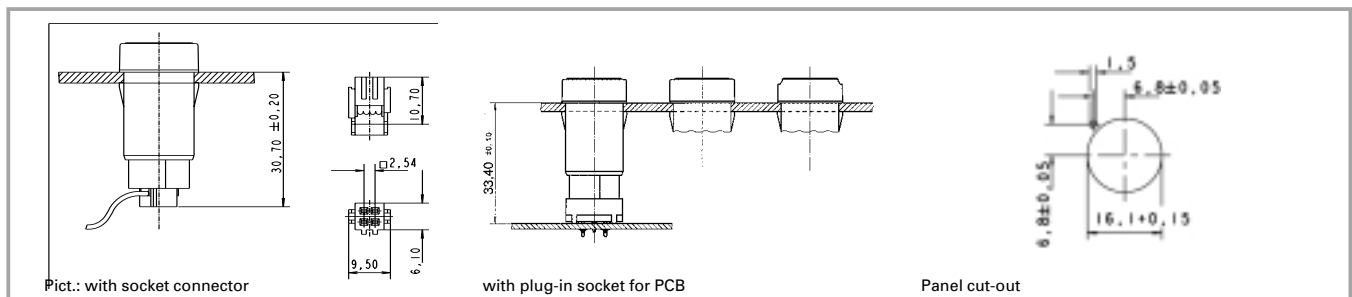
LUMOTAST FK illuminated pushbutton, 42 V/100 mA

Pict.: with socket connector

with plug-in socket for PCB

Panel cut-out

1

LUMO
FK**Technical data****General information**

Form of lens	flat lens
Colour of lens	see order block
Form of collar	see order block

Dimensions

Length of collar	see order block
Width of collar	see order block
Diameter of collar	see order block
Overall height	6.6 mm
Mounting depth with connector	30.7 mm
Mounting depth with plug-in socket	33.4 mm
Mounting hole	16.2 mm

Mechanical design

Mounting	click quick connection
Terminals	pin connector 4-pol./ plug-in socket
Contact system	snap-action contact
Contact function	momentary
Contact arrangement	1 NO
Contact materials	Au
Illuminability	yes
Lamp socket	Bi-Pin T 1/T 1¼

Mechanical characteristics

Operating force max.	6 N
Operating travel	3 mm
Switching travel	1.9 mm
Robustness min.	100 N





Electrical characteristics

Rated voltage AC/DC max.	42 V
Rated voltage AC/DC min.	0.02 V
Rated current AC/DC max.	100 mA
Rated current AC/DC min.	0.01 mA
Contact resistance acc. to life max.	300 mΩ
Contact resistance when new max.	100 mΩ

Other specifications

Operating life	1000000
Degree of protection from front side	IP65
Ambient temp. operating min.	-25 °C
Ambient temp. operating without lamp max.	+70 °C
Ambient temp. operating with lamp max.	+55 °C
Storage temperature min.	-40 °C
Storage temperature max.	+80 °C
Resistance to constant environment	according to EC 600 68-2-3 and 2-30
Resistance at variable environment	according to IEC 600 68-2-14 and 2-33
Weight	6 g

Accessories LUMOTAST FK illuminated pushbutton, 42 V/100 mA

Description	Photo	Order no.	Page
Filament lamp, Bi-Pin T 1¼ base, 12 V		1.90.180.474/0000	5 - 5
Filament lamp, Bi-Pin T 1¼ base, 28 V		1.90.180.475/0000	5 - 5
LED Bi-Pin T 1 superbright, red, 24 V		1.90.690.351/0000	5 - 18
LED Bi-Pin T 1 superbright, green, 24 V		1.90.690.352/0000	5 - 18



LUMOTAST FK

Accessories LUMOTAST FK illuminated pushbutton, 42 V/100 mA

Description	Photo	Order no.	Page
LED Bi-Pin T 1 superbright, yellow, 24 V		1.90.690.353/0000	5 - 18
LED Bi-Pin T 1 superbright, blue, 24 V		1.90.690.354/0000	5 - 18
LED Bi-Pin T 1 superbright, white, 24 V		1.90.690.355/0000	5 - 18
LED Bi-Pin T 1, red, 3 V		1.90.691.026/0000	5 - 17
LED Bi-Pin T 1, green, 3 V		1.90.691.027/0000	5 - 17
LED Bi-Pin T 1, yellow, 3 V		1.90.691.028/0000	5 - 17
Plug-in socket for PCB		5.00.645.036/0000	5 - 28
Cable (flat ribbon cable 10 cm with socket connector and male quick connector, AMP 4-pin)		5.03.771.306/0000	5 - 27
Disassembly tool for LUMOTAST FK		5.05.800.041/0000	5 - 26
Flat ribbon cable, 4-wire, 1 m long		5.37.700.124/0000	5 - 27
Socket connector, 4-pin		5.92.025.368/0000	5 - 26

LUMOTAST FK illuminated pushbutton, square collar, 42 V/100 mA

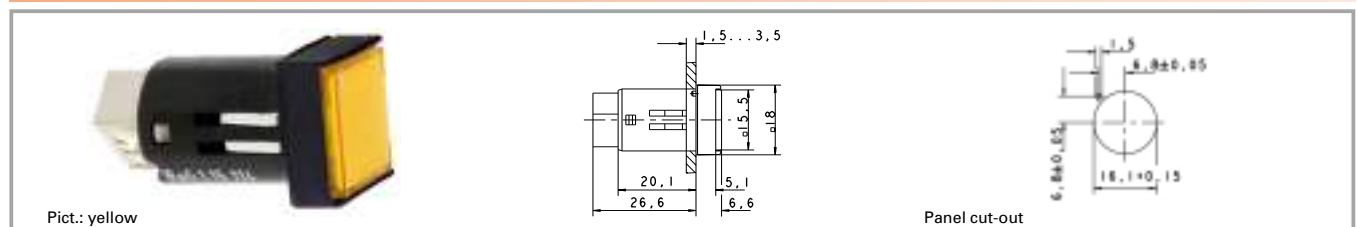

Contact function	Contact arrangement	Colour of lens	Order no. complete	Order no. single parts	
				Housing	Lens
momentary	1 NO	transparent colourless	1.15.114.006/1002	1.15.114.906/0000	5.49.075.015/1002
momentary	1 NO	transparent red	1.15.114.006/1306	1.15.114.906/0000	5.49.075.015/1306
momentary	1 NO	transparent yellow	1.15.114.006/1403	1.15.114.906/0000	5.49.075.015/1403
momentary	1 NO	transparent green	1.15.114.006/1505	1.15.114.906/0000	5.49.075.015/1505
momentary	1 NO	transparent blue	1.15.114.006/1607	1.15.114.906/0000	5.49.075.015/1607

Technical data see page 1 - 12

Accessories:

Legend insert, square, without legend: 5.70.638.000/2000

A notch on the lamp socket identifies the cathode side.

Pushbuttons

Stock items are marked
by **bold printed** order numbers.

1 - 13

LUMOTAST FK illuminated pushbutton, round collar, 42 V/100 mA

Pict.: green

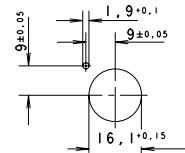
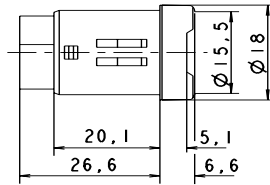

Panel cut-out

Contact function	Contact arrangement	Colour of lens	Order no. complete	Order no. single parts	
				Housing	Lens
momentary	1 NO	transparent colourless	1.15.114.036/1002	1.15.114.936/0000	5.49.075.016/1002
momentary	1 NO	transparent red	1.15.114.036/1306	1.15.114.936/0000	5.49.075.016/1306
momentary	1 NO	transparent yellow	1.15.114.036/1403	1.15.114.936/0000	5.49.075.016/1403
momentary	1 NO	transparent green	1.15.114.036/1505	1.15.114.936/0000	5.49.075.016/1505
momentary	1 NO	transparent blue	1.15.114.036/1607	1.15.114.936/0000	5.49.075.016/1607

Technical data see page 1 - 12

Accessories:

Legend insert, round, without legend: **5.70.634.000/2000**

A notch on the lamp socket identifies the cathode side.

LUMOTAST FK illuminated pushbutton, rectangular collar, 42 V/100 mA

Pict.: red

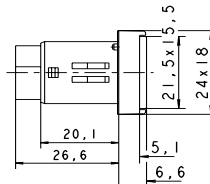

Panel cut-out

Contact function	Contact arrangement	Colour of lens	Order no. complete	Order no. single parts	
				Housing	Lens
momentary	1 NO	transparent colourless	1.15.114.066/1002	1.15.114.966/0000	5.49.075.017/1002
momentary	1 NO	transparent red	1.15.114.066/1306	1.15.114.966/0000	5.49.075.017/1306
momentary	1 NO	transparent yellow	1.15.114.066/1403	1.15.114.966/0000	5.49.075.017/1403
momentary	1 NO	transparent green	1.15.114.066/1505	1.15.114.966/0000	5.49.075.017/1505
momentary	1 NO	transparent blue	1.15.114.066/1607	1.15.114.966/0000	5.49.075.017/1607

Technical data see page 1 - 12

Accessories:

Legend insert, rectangular, without legend: **5.70.639.000/2000**

A notch on the lamp socket identifies the cathode side.

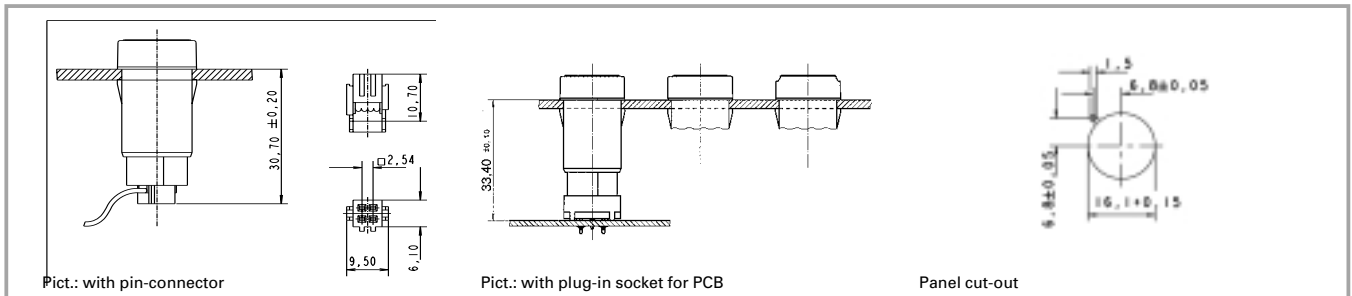
LUMOTAST FK signal lamp

Pict.: with pin-connector

Pict.: with plug-in socket for PCB

Panel cut-out

LUMO
FK**Technical data****General information**

Form of lens	flat lens
Colour of lens	see order block
Form of collar	see order block

Dimensions

Length of collar	see order block
Width of collar	see order block
Mounting depth with connector	30.7 mm
Mounting depth with plug-in socket	33.4 mm
Mounting hole	16.2 mm

Mechanical design

Mounting	click quick connection
Terminals	pin connector 4-pol./ plug-in socket
Lamp socket	Bi-Pin T 1/T 1¼
Lamp	filament lamp / LED







Electrical characteristics

Voltage limit max.	24 V
Power limit max.	0.7 W

Other specifications

Degree of protection from front side	IP65
Weight	5 g
Ambient temp. operating min.	-25 °C
Ambient temp. operating max.	+55 °C
Storage temperature min.	-40 °C
Storage temperature max.	+80 °C
Resistance to constant environment	according to IEC 600 68-2-3 and 2-30
Resistance at variable environment	according to IEC 600 68-2-14 and 2-33

Accessories LUMOTAST FK signal lamp

Description	Photo	Order no.	Page
Filament lamp, Bi-Pin T 1¼ base, 12 V		1.90.180.474/0000	5 - 5
Filament lamp, Bi-Pin T 1¼ base, 28 V		1.90.180.475/0000	5 - 5
LED Bi-Pin T 1 superbright, red, 24 V		1.90.690.351/0000	5 - 18
LED Bi-Pin T 1 superbright, green, 24 V		1.90.690.352/0000	5 - 18
LED Bi-Pin T 1 superbright, yellow, 24 V		1.90.690.353/0000	5 - 18
LED Bi-Pin T 1 superbright, blue, 24 V		1.90.690.354/0000	5 - 18
LED Bi-Pin T 1 superbright, white, 24 V		1.90.690.355/0000	5 - 18



LUMOTAST FK

Accessories LUMOTAST FK signal lamp

Description	Photo	Order no.	Page
LED Bi-Pin T 1, red, 3 V		1.90.691.026/0000	5 - 17
LED Bi-Pin T 1, green, 3 V		1.90.691.027/0000	5 - 17
LED Bi-Pin T 1, yellow, 3 V		1.90.691.028/0000	5 - 17
Plug-in socket for PCB		5.00.645.036/0000	5 - 28
Cable (flat ribbon cable 10 cm with socket connector and male quick connector, AMP 4-pin)		5.03.771.306/0000	5 - 27
Disassembly tool for LUMOTAST FK		5.05.800.041/0000	5 - 26
Flat ribbon cable, 4-wire, 1 m long		5.37.700.124/0000	5 - 27
Socket connector, 4-pin		5.92.025.368/0000	5 - 26

LUMOTAST FK signal lamp, square collar

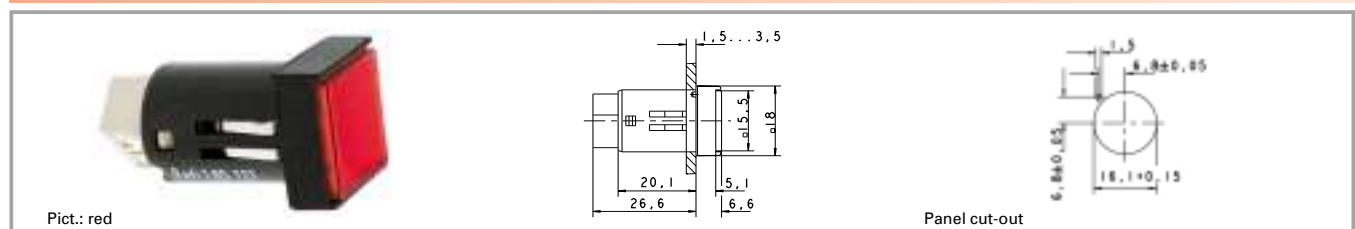

Power limit max.	Voltage limit max.	Lamp socket	Colour of lens	Order no. complete	Order no. single parts	
					Housing	Lens
0.7 W	24 V	Bi-Pin T 1/T 1 ¹ / ₄	transparent colourless	1.65.121.006/1002	1.65.121.906/0000	5.49.075.015/1002
0.7 W	24 V	Bi-Pin T 1/T 1 ¹ / ₄	transparent red	1.65.121.006/1306	1.65.121.906/0000	5.49.075.015/1306
0.7 W	24 V	Bi-Pin T 1/T 1 ¹ / ₄	transparent yellow	1.65.121.006/1403	1.65.121.906/0000	5.49.075.015/1403
0.7 W	24 V	Bi-Pin T 1/T 1 ¹ / ₄	transparent green	1.65.121.006/1505	1.65.121.906/0000	5.49.075.015/1505
0.7 W	24 V	Bi-Pin T 1/T 1 ¹ / ₄	transparent blue	1.65.121.006/1607	1.65.121.906/0000	5.49.075.015/1607

Technical data see page 1 - 16

Accessories:

Legend insert, square, without legend: 5.70.638.000/2000

Do not press in lens in disassembled condition.

A notch on the lamp socket identifies the cathode side.

LUMOTAST FK signal lamp, round collar

Pict.: yellow

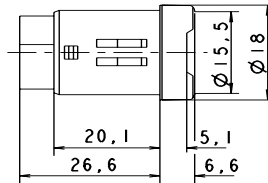

Panel cut-out

Power limit max.	Voltage limit max.	Lamp socket	Colour of lens	Order no. complete	Order no. single parts	
					Housing	Lens
0.7 W	24 V	Bi-Pin T 1/T 1 ¹ / ₄	transparent colourless	1.65.121.036/1002	1.65.121.936/0000	5.49.075.016/1002
0.7 W	24 V	Bi-Pin T 1/T 1 ¹ / ₄	transparent red	1.65.121.036/1306	1.65.121.936/0000	5.49.075.016/1306
0.7 W	24 V	Bi-Pin T 1/T 1 ¹ / ₄	transparent yellow	1.65.121.036/1403	1.65.121.936/0000	5.49.075.016/1403
0.7 W	24 V	Bi-Pin T 1/T 1 ¹ / ₄	transparent green	1.65.121.036/1505	1.65.121.936/0000	5.49.075.016/1505
0.7 W	24 V	Bi-Pin T 1/T 1 ¹ / ₄	transparent blue	1.65.121.036/1607	1.65.121.936/0000	5.49.075.016/1607

Technical data see page 1 - 16

Accessories:Legend insert, round, without legend: **5.70.634.000/2000**

Do not press in lens in disassembled condition.

A notch on the lamp socket identifies the cathode side.

LUMOTAST FK signal lamp, rectangular collar

Pict.: blue

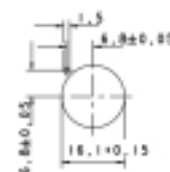
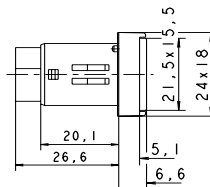

Panel cut-out

Power limit max.	Voltage limit max.	Lamp socket	Colour of lens	Order no. complete	Order no. single parts	
					Housing	Lens
0.7 W	24 V	Bi-Pin T 1/T 1 ¹ / ₄	transparent colourless	1.65.121.066/1002	1.65.121.966/0000	5.49.075.017/1002
0.7 W	24 V	Bi-Pin T 1/T 1 ¹ / ₄	transparent red	1.65.121.066/1306	1.65.121.966/0000	5.49.075.017/1306
0.7 W	24 V	Bi-Pin T 1/T 1 ¹ / ₄	transparent yellow	1.65.121.066/1403	1.65.121.966/0000	5.49.075.017/1403
0.7 W	24 V	Bi-Pin T 1/T 1 ¹ / ₄	transparent green	1.65.121.066/1505	1.65.121.966/0000	5.49.075.017/1505
0.7 W	24 V	Bi-Pin T 1/T 1 ¹ / ₄	transparent blue	1.65.121.066/1607	1.65.121.966/0000	5.49.075.017/1607

Technical data see page 1 - 16

Accessories:Legend insert, rectangular, without legend: **5.70.639.000/2000**

Do not press in lens in disassembled condition.

A notch on the lamp socket identifies the cathode side.