

Digital Counter/Tachometer H7CC

New and improved design for easier use, programming, maintenance and user feedback
The improved user interface is intuitive and offers better overall visibility. Replacement time notification function notifies the user of potential preventive maintenance



NEW

For the most recent information on models that have been certified for safety standards, refer to your OMRON website.

Refer to *Safety Precautions* page 61.

Basic Features

- The white-color display offers better visual clarity and visibility, and the color universal design is used.
- Up/Down Keys are provided for all six digits, which reduces the number of button operations during setup and other processes.
- An easy operation is realized by the operation guide on which each key lights up.
- The progress can be easily understood at one glance from the status indicators of the present value and the measurement value.
- The body depth of all models with screw terminals has been reduced to 59 mm.

Safety and Reliability

- The replacement time is notified in advance by predicting the service life.
- The power supply circuit and input circuits are isolated in all models, and therefore, there is no need of any wiring restrictions.

Other Features

- Follows the ratings, characteristics, and functionality of the H7CX-N.
- Equipped with the Output Allocation and Output ON/OFF Inversion Function.
- Equipped with a Memory Backup and H7AN Compatibility Function to facilitate problem-free conversion from H7CN/H7AN.

Features

Basic Features

Better visual feedback and operation

The white-color display offers better visual clarity and visibility, and the color universal design is used. The keys of all six digits can be operated up/down for easier use. The LED indicator of the operable keys lights up to support setup.

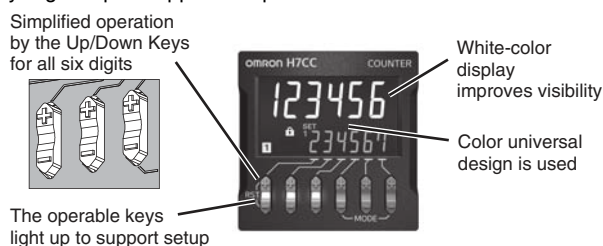

Status Notification by Status Indicator

The status can be indicated by the ratio of the present value or measurement value to the set value, which makes it easy to understand the status.

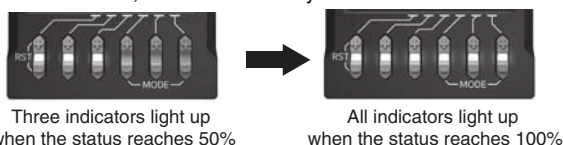

Shortened Body

The body depth of all models with screw terminals has been reduced to 59 mm, which contributes to thinner control panels!

Models with Screw Terminals: 59 mm

Models with Sockets:
63.7 mm (case dimension)

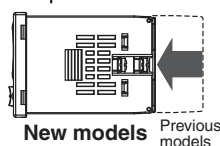

Safety and Reliability

Notification of Replacement Time

The service life prerequisites of the counter include the relay output count and the deterioration of the electrolytic capacitors. In the H7CC, in addition to the relay output count, an alarm is displayed when the deterioration of electrolytic capacitors due to the cumulative run time reaches the standard value, and planned maintenance is supported.

Note: For details, refer to *Replacement Time Notification Function* on pages 41 and 57.

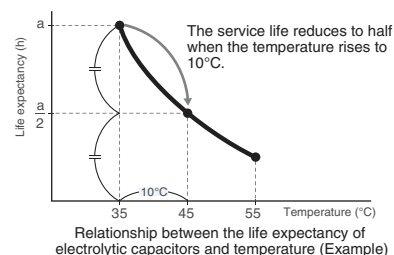

Isolated Power Supply and Input Circuits

In all models, the power supply circuit and input circuits are isolated. Previous non-isolated counters had wiring restrictions and could be damaged if wired incorrectly. The H7CC removes these worries.

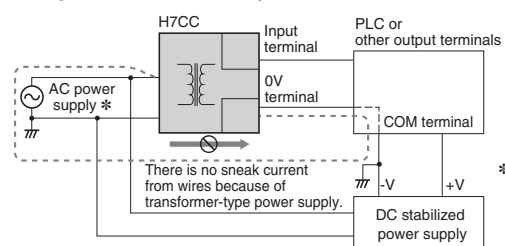

* Grounding of AC power supply implies grounding at the commercial power supply side.

Other Features

Equipped with a Key Protect Function

Any abnormality in the device due to malfunctioning or setting errors can be prevented.

Follows the Ratings, Characteristics, and Functionality of the H7CX-N

The H7CC follows the ratings, characteristics, and functionality of the H7CX-N. Other than the H7CC-A8□, all models are equipped with power supply to external devices, which reduces the load on wiring.

Output Allocation Function

The allocation of outputs 1 and 2 (OUT1 and OUT2) can be changed. In the conventional 2-stage output models, output 1 (OUT1) was fixed as SPST, and output 2 (OUT2) was fixed as SPDT, however, in the H7CC, the allocation of outputs 1 and 2 (OUT1 and OUT2) can be changed to SPST or SPDT, which reduces the man-hours involved when it is necessary to change the wiring.

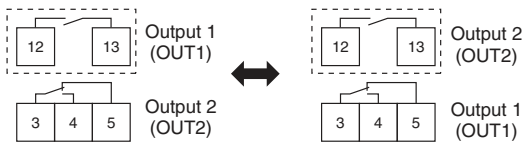

Output ON/OFF Inversion Function

Conventionally, the output turns ON when the set value is reached, however, when this function is used, the output can be turned OFF when the set value is reached. As a result, the man-hours involved in checking the wiring can be reduced.

Memory Backup Function



Conversion from the H7CN/H7AN is supported by enabling the setting of the present value and the output state memory backup.

H7AN Compatibility Function

Conversion from the H7AN is supported by enabling the setting to start counting from 999999 when the present value being decremented exceeds 0.

Model Number Structure

Model Configuration

H7CC Series					
		H7CC-A Series Digital Counter		H7CC-R Series Digital Tachometer	
Model					
Classification		Preset counter	Preset counter/Tachometer	Tachometer	
Model		H7CC-A□	H7CC-AW□/AU□	H7CC-R11□	H7CC-R11W□
Function	1-stage preset counter	Yes	Yes	No	
	2-stage preset counter	No	Yes	No	
	Total and preset counter	Yes	Yes	No	
	Batch counter	No	Yes	No	
	Dual counter	No	Yes	No	
	Twin counter	No	Yes	No	
	Tachometer	No	Yes *	Yes	
Tachometer Input		---	1 input or 2 inputs (independent measurements, differential, absolute ratio value and error ratio value)	Yes 1 input	Yes 2 inputs (independent measurement only)
Settings		1-stage	2-stage	1-stage	
External connections		8-pin socket, 11-pin socket, Screw terminals		11-pin socket	
Display digits		6 digits			

* Set the tachometer input mode from the function setting mode to switch to the tachometer function.

Model Number Legend (Not all possible combinations of functions are available.)

H7CC-□□□□□
 1 2 3 4 5

1. Type

Symbol	Meaning
A	Standard type
R	Tachometer

2. External connections

Symbol	Meaning
None	Screw terminals
8	8-pin socket
11	11-pin socket

3. Settings

Symbol	Meaning
None	1-stage setting
W	2-stage setting *
U	1-stage contact+1-stage Solid state

* The H7CC-R11W□ is a 1-stage (2 inputs and outputs) rather than a 2-stage counter.

4. Output type

Symbol	Meaning
None	Contact output
S	Transistor output

5. Supply voltage

Symbol	Meaning
None	100 to 240 VAC at 50/60 Hz
D	24 VAC 50/60 Hz/12-48 VDC

Ordering Information

List of Models

Type	Classification	Configuration	External connections	Settings	Display digits	Outputs	Power supply voltage	Model
H7CC-A Series	Preset counter	<ul style="list-style-type: none"> 1-stage preset counter Total and preset counter 	8-pin socket	1-stage	6 digits	Contact output (SPST)	100 to 240 VAC	H7CC-A8
			11-pin socket			Contact output (SPDT)	24 VAC/12 to 48 VDC	H7CC-A8D
						Transistor output (SPST)		100 to 240 VAC
			Screw terminals			Contact output (SPDT)	24 VAC/12 to 48 VDC	H7CC-A11S
						Transistor output (SPST)		H7CC-A11D
			Preset counter/Tachometer			<ul style="list-style-type: none"> 1-stage preset counter 2-stage preset counter Total and preset counter Batch counter Dual counter Twin counter Tachometer 	2-stage	Contact output (SPDT)
	Transistor output (SPST)	H7CC-AS						
	Contact output (SPDT)	24 VAC/12 to 48 VDC		H7CC-AD				
	Transistor output (SPST)	H7CC-ASD						
	Contact output (SPST+SPDT)	100 to 240 VAC		H7CC-AW				
	Transistor output (DSPT)	H7CC-AWS						
	H7CC-R Series	Tachometer	<ul style="list-style-type: none"> Tachometer 	11-pin socket		1-stage (1 input and output)	Contact output (SPST)	100 to 240 VAC
1 stage (2 inputs and outputs)					Contact output (SPDT)	24 VAC/12 to 48 VDC	H7CC-R11D	
					Contact output (SPST+SPDT)	100 to 240 VAC	H7CC-R11W	
2-stage					Contact output (SPST+SPDT)	24 VAC/12 to 48 VDC	H7CC-R11WD	
					Contact output (SPDT) + Transistor output (SPST)	100 to 240 VAC	H7CC-AU	
Transistor output (DSPT)					24 VAC/12 to 48 VDC	H7CC-AUD		

Accessories (Order Separately)

Soft Cover

Model	Remarks	Page
Y92A-48F1	---	12

Hard Cover

Model	Remarks	Page
Y92A-48	---	12

Flush Mounting Adapter

Model	Remarks	Page
Y92F-30	Included with models with screw terminals.	12
Y92F-45	Use this Adapter to install the Counter/Tachometer in a cutout previously made for a DIN 72 × 72 mm device (panel cutout: 68 × 68 mm).	

Waterproof Packing

Model	Remarks	Page
Y92S-29	Included with models with screw terminals.	12

Connection Sockets

Model	Classification	Connectable Counter/Tachometers	Remarks	Page
P2CF-08	Front-connecting Socket	H7CC-□8	---	13
P2CF-08-E	Front-connecting Socket (Finger-safe Type)		Round crimp terminals cannot be used on Finger-safe Sockets. Use forked crimp terminals.	
P3GA-08	Back-connecting Sockets		A Y92A-48G Terminal Cover can be used with the Socket to create a finger-safe construction.	
P2CF-11	Front-connecting Socket	H7CC-□11	---	
P2CF-11-E	Front-connecting Socket (Finger-safe Type)		Round crimp terminals cannot be used on Finger-safe Sockets. Use forked crimp terminals.	
P3GA-11	Back-connecting Sockets		A Y92A-48G Terminal Cover can be used with the Socket to create a finger-safe construction.	

Terminal Covers for P3GA-11 Back-connecting Socket

Model	Remarks	Page
Y92A-48G	---	14

H7CC-A□ Digital Counter



For the most recent information on models that have been certified for safety standards, refer to your OMRON website.

Specifications

Ratings

Item		Model	H7CC-A8/-A11□	H7CC-A□	H7CC-AW□/AU□
Classification			Preset counter		Preset counter/ tachometer
Configuration			1-stage preset counter, 1-stage preset counter with total counter (selectable) *1		1-stage/2-stage preset counter, total and preset counter *1, batch counter, dual counter, twin counter, and tachometer (selectable)
Ratings	Power supply voltage *2		<ul style="list-style-type: none"> • 100 to 240 VAC, 50/60 Hz • 24 VAC, 50/60 Hz or 12 to 48 VDC 		
	Operating voltage fluctuation range		85% to 110% of rated supply voltage (12 to 48 VDC: 90% to 110%)		
	Power consumption		Approx. 6.8 VA at 100 to 240 VAC, Approx. 5.5 VA/3.3 W at 24 VAC/12 to 48 VDC,		
Mounting method			Flush mounting or surface mounting	Flush mounting	
External connections			8-pin/ 11-pin socket	Screw terminals	
Degree of protection			IEC IP66 for panel surface only and only when Y92S-29 Waterproof Packing is used.		
Input signals			CP1, CP2, reset, and total reset *4		CP1, CP2, reset 1, and reset 2
Counter	Maximum counting speed		30 Hz (minimum pulse width: 16.7 ms) or 10 kHz (minimum pulse width: 0.05 ms) (selectable) (ON/OFF ratio 1:1) *Common setting for CP1 and CP2		
	Input mode		Increment (UP), decrement (DOWN), increment/decrement (UP/DOWN A (command input), UP/DOWN B (individual inputs), or UP/DOWN C (quadrature inputs)), UP/DOWN D (command input), UP/DOWN E (individual inputs), UP/DOWN E (quadrature inputs)		
	Output mode		N, F, C, R, K-1, P, Q, A, K-2, D, and L.		N, F, C, R, K-1, P, Q, A, K-2, D, L, and H.
	One-shot out put time		0.01 to 99.99 s		
	Reset system		External (minimum reset signal width: 1 ms or 20 ms, selectable), manual, and automatic reset (internal according to C, R, P, and Q mode operation)		
Tachometer			Refer to the separate table for <i>tachometer function ratings</i> .		
Prescaling function			Yes (0.001 to 99.999)		
Decimal point adjustment			Yes (right most 3 digits)		
Sensor waiting time			290 ms max. (Control output is turned OFF and no input is accepted during sensor waiting time.)		
Input method			No-voltage (NPN) input/voltage (PNP) input (switchable) No-voltage inputs: ON impedance: 1 kΩ max. (Leakage current: 12 mA at 0 Ω) ON residual voltage: 3 V max. OFF impedance: 100 kΩ min. Voltage input: High (logic) level: 4.5 to 30 VDC Low (logic) level: 0 to 2 VDC (Input resistance: approx. 4.7 kΩ)		
External power supply			12 VDC (±10%), 100 mA (except for H7CC-A8□ models) Refer to <i>Precautions for Correct Use</i> on page 61 for details.		
Control output			<ul style="list-style-type: none"> • Contact output: 3 A at 250 VAC/30 VDC, resistive load (cosφ=1), Minimum applied load: 10 mA at 5 VDC (failure level: P, reference value) • Transistor output: NPN open collector, 100 mA at 30 VDC, Residual voltage: 1.5 VDC max. (approx. 1 V), Leakage current: 0.1 mA max. 		
Display *3			7-segment, negative transmissive LCD Character height Count value: 10 mm (white) Set value: 6 mm (green)		
Digits			6 digits -99999 to 999999 (-5 digits to +6 digits)		6 digits -99999 to 999999 (-5 digits to +6 digits), tachometer: 0 to 999999
Memory backup			Non-volatile memory (overwrites: 100,000 times min.) that can store data for 10 years min.		
Operating temperature range			-10 to 55°C (-10 to 50°C if Counter/Tachometers are mounted side by side) (with no icing or condensation)		
Storage temperature range			-25 to 70°C (with no icing or condensation)		
Operating humidity range			25% to 85%		
Case color			Black (N1.5)		
Attachments			---	Flush mounting adapter, waterproof packing, terminal cover	

*1. 1-stage preset counter and total counter functionality.

*2. Do not use the output from an inverter as the power supply. The ripple must be 20% maximum for DC power.

*3. The display is lit only when the power is ON. Nothing is displayed when power is OFF.

*4. Only reset input is performed in the H7CC-A8□, and the total count is also reset simultaneously.

Tachometer Function Ratings

Item	Model	H7CC-AW□/AU□			
Input mode	No tachometer functionality	Selectable from 1 inputs, independent measurements for 2 inputs, differential input for 2 inputs, absolute ratio for 2 inputs, and error ratio for 2 inputs.			
Pulse measurement method		Periodic measurement		Pulse width measurement	
Maximum counting speed		30 Hz (minimum pulse width: 16.7 ms)	1-input mode: 10 kHz (minimum pulse width: 0.05 ms) Other modes: 5 kHz (minimum pulse width: 0.1 ms)	30 Hz (minimum pulse width: 16.7 ms)	1-input mode: 10 kHz (minimum pulse width: 0.05 ms) Other modes: 5 kHz (minimum pulse width: 0.1 ms)
Minimum input signal width		---	---	30 ms *	1-input mode: 0.2 ms Other modes: 0.4 ms*
Measuring ranges		0.001 to 30.00 Hz	1-input mode: 0.001 to 10 kHz, Other modes: 0.01 to 5 kHz	0.030 to 999999 s	1-input mode: 0.0002 to 999999 s Other modes: 0.0004 to 999999 s
Sampling period		200 ms min.	200 ms min. or continuous selectable (minimum interval of 10 ms)	Continuous (minimum interval of 10 ms)	
Measuring accuracy		±0.1% FS ±1 digit max. (at 23 ±5°C)			
Output mode		Input mode: Not 2-input independent measurement: HI-LO, AREA, HI-HI, LO-LO 2-input independent measurement: HI-HI, LO-LO			
Auto-zero time		0.1 to 999.9s			
Startup time		0.0 to 99.9s			
Averaging	Simple averaging/moving averaging selectable, Processing: OFF, 2, 4, 8, or 16 times				
Hold input	Minimum input signal width: 20 ms				

* An input OFF time of at least 20 ms is required.

Characteristics

Insulation resistance	100 MΩ min. (at 500 VDC) between current-carrying terminals and exposed non-current-carrying metal parts, and between non-continuous contacts	
Dielectric strength	2,000 VAC, 50/60 Hz for 1 min between current-carrying metal parts and non-current-carrying metal parts 2,000 VAC, 50/60 Hz for 1 min between power supply and input circuit for all models except H7CC-□D□ (1,500 VAC for 24 VAC/12 to 48 VDC) 1,500 VAC (for H7CC-□SD□), 50/60 Hz for 1 min between control output, power supply, and input circuit (2,000 VAC for models other than H7CC-□SD□) 1,000 VAC, 50/60 Hz for 1 min between non-continuous contacts	
Impulse withstand voltage	6.0 kV between power terminals (1.0 kV for models with 24 VAC/12 to 48 VDC) 6.0 kV between current-carrying terminals and exposed non-current-carrying metal parts (1.5 kV for models with 24 VAC/12 to 48 VDC)	
Static immunity	Malfunction: 8 kV Destruction: 15 kV	
Vibration resistance	Destruction	10 to 55 Hz with 0.75-mm single amplitude each in three directions for 2 h each
	Malfunction	10 to 55 Hz with 0.35-mm single amplitude each in three directions for 10 min each
Shock resistance	Destruction	300 m/s ² each in three directions
	Malfunction	100 m/s ² each in three directions
Life expectancy	Mechanical: 10,000,000 operations min. Electrical: 100,000 operations min. (3 A at 250 VAC, resistive load, ambient temperature condition: 23°C) *	
Weight	Approx. 120 g (Counter only)	

* Refer to the Life-test Curve.

Life-test Curve (Reference Values)

Resistive load

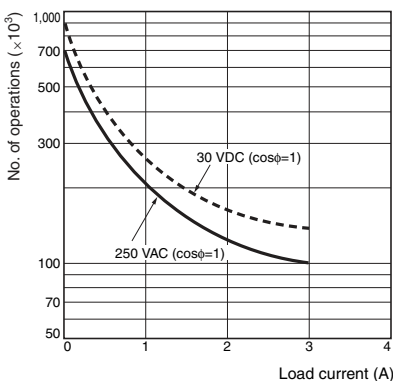

Inductive load

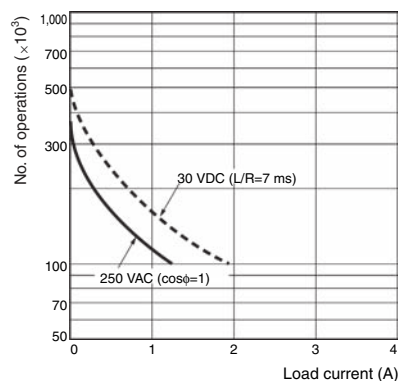

A current of 0.15 A max. can be switched at 125 VDC (cosφ=1) and current of 0.1 A max. can be switched if L/R=7 ms. In both cases, a life of 100,000 operations can be expected.

Applicable Standards

Approved safety standards	cULus (or cURus): UL508/GSA C22.2 No. 14 *1 EN 61010-1 (IEC 61010-1): Pollution degree 2/overvoltage category II EAC RCM B300 PILOT DUTY 1/4 HP 120 VAC, 1/3 HP, 240 VAC, 3 A, 250 VAC/30 VDC resistive load VDE0106/part100																														
	EMC	<table border="0"> <tr> <td>(EMI)</td> <td>EN61326-1 *2</td> <td></td> </tr> <tr> <td>Emission Enclosure:</td> <td>EN 55011 Group 1 class A</td> <td></td> </tr> <tr> <td>Emission AC mains:</td> <td>EN 55011 Group 1 class A</td> <td></td> </tr> <tr> <td>(EMS)</td> <td>EN61326-1 *2</td> <td></td> </tr> <tr> <td>Immunity ESD:</td> <td>EN 61000-4-2:</td> <td>4 kV contact discharge; 8 kV air discharge</td> </tr> <tr> <td>Immunity RF-interference:</td> <td>EN 61000-4-3:</td> <td>10 V/m (Amplitude-modulated, 80 MHz to 1 GHz) 3 V/m (Amplitude-modulated, 1.4 G to 2 GHz) 1 V/m (Amplitude-modulated, 2 G to 2.7 GHz) 10 V/m (Pulse-modulated, 900 MHz ±5 MHz)</td> </tr> <tr> <td>Immunity Conducted Disturbance:</td> <td>EN 61000-4-6:</td> <td>10 V (0.15 to 80 MHz)</td> </tr> <tr> <td>Immunity Burst:</td> <td>EN 61000-4-4:</td> <td>2 kV power-line; 1 kV I/O signal-line</td> </tr> <tr> <td>Immunity Surge:</td> <td>EN 61000-4-5:</td> <td>1 kV line to lines (power and output lines); 2 kV line to ground (power and output lines)</td> </tr> <tr> <td>Immunity Voltage Dip/Interruption:</td> <td>EN 61000-4-11:</td> <td>Voltage Dip 1 cycle, 100% (rated voltage) 10/12 cycle 60% (rated voltage) 25/30 cycle 30% (rated voltage) Interruption 250/300 cycle 100% (rated voltage)</td> </tr> </table>	(EMI)	EN61326-1 *2		Emission Enclosure:	EN 55011 Group 1 class A		Emission AC mains:	EN 55011 Group 1 class A		(EMS)	EN61326-1 *2		Immunity ESD:	EN 61000-4-2:	4 kV contact discharge; 8 kV air discharge	Immunity RF-interference:	EN 61000-4-3:	10 V/m (Amplitude-modulated, 80 MHz to 1 GHz) 3 V/m (Amplitude-modulated, 1.4 G to 2 GHz) 1 V/m (Amplitude-modulated, 2 G to 2.7 GHz) 10 V/m (Pulse-modulated, 900 MHz ±5 MHz)	Immunity Conducted Disturbance:	EN 61000-4-6:	10 V (0.15 to 80 MHz)	Immunity Burst:	EN 61000-4-4:	2 kV power-line; 1 kV I/O signal-line	Immunity Surge:	EN 61000-4-5:	1 kV line to lines (power and output lines); 2 kV line to ground (power and output lines)	Immunity Voltage Dip/Interruption:	EN 61000-4-11:
(EMI)	EN61326-1 *2																														
Emission Enclosure:	EN 55011 Group 1 class A																														
Emission AC mains:	EN 55011 Group 1 class A																														
(EMS)	EN61326-1 *2																														
Immunity ESD:	EN 61000-4-2:	4 kV contact discharge; 8 kV air discharge																													
Immunity RF-interference:	EN 61000-4-3:	10 V/m (Amplitude-modulated, 80 MHz to 1 GHz) 3 V/m (Amplitude-modulated, 1.4 G to 2 GHz) 1 V/m (Amplitude-modulated, 2 G to 2.7 GHz) 10 V/m (Pulse-modulated, 900 MHz ±5 MHz)																													
Immunity Conducted Disturbance:	EN 61000-4-6:	10 V (0.15 to 80 MHz)																													
Immunity Burst:	EN 61000-4-4:	2 kV power-line; 1 kV I/O signal-line																													
Immunity Surge:	EN 61000-4-5:	1 kV line to lines (power and output lines); 2 kV line to ground (power and output lines)																													
Immunity Voltage Dip/Interruption:	EN 61000-4-11:	Voltage Dip 1 cycle, 100% (rated voltage) 10/12 cycle 60% (rated voltage) 25/30 cycle 30% (rated voltage) Interruption 250/300 cycle 100% (rated voltage)																													
		<p>*1. The following safety standards apply to models with sockets (H7CC-A11□/H7CC-A8□). cUL (Listing): Applicable when an OMRON P2CF(-E) Socket is used. cUR (Recognition): Applicable when any other socket is used.</p> <p>*2. Industrial electromagnetic environment (EN/IEC 61326-1 Table 2)</p>																													

I/O Functions

Using as a Counter*1

Inputs	CP1, CP2	<p>(1) In general (except for Dual Counter Mode)</p> <ul style="list-style-type: none"> Reads counting signals. Increment, decrement, increment/decrement (command/individual/quadrature) inputs accepted. <p>(2) When used as a dual counter or twin counter</p> <ul style="list-style-type: none"> Reads CP1 count signals with CP1 input and CP2 count signals with CP2 input. Increment signals can be input.
	Reset/reset 1	<p>(1) In general (except for Dual Counter Mode)</p> <ul style="list-style-type: none"> Resets present value and outputs (OUT2 when using the batch counter) *2. Counting cannot be performed during reset/reset 1 input. Reset indicator is lit while reset input is ON. <p>(2) When used as a dual counter or twin counter.</p> <ul style="list-style-type: none"> Resets the CP1 present value (to 0). Counting for CP1 input cannot be performed while the reset 1 input is ON. The reset indicator is lit while the reset 1 input is ON.
	Total reset or reset 2	The reset function depends on the selected configuration *3.
Outputs	OUT1, OUT2	Outputs signals according to the specified output mode when a set value is reached.

*1. For information on operation of I/O functions, refer to pages page 24 to page 29.

*2. In increment mode or increment/decrement mode, the present value returns to 0; in decrement mode, the present value returns to the set value with 1-stage models, and returns to set value 2 with 2-stage models.

*3. Reset operates as described in the following table. (The reset indicator will not be lit.)

Configuration	Reset operation
1-stage/2-stage preset counter	Does not operate (not used).
Total and preset counter	<ul style="list-style-type: none"> Resets the total count value. The total count value is held at 0 while the total reset input is ON.
Batch counter	<ul style="list-style-type: none"> Resets the batch count value and batch output (OUT1). The batch count value is held at 0 while the reset 2 input is ON.
Dual counter	<ul style="list-style-type: none"> Resets the CP2 present value. Counting for CP2 input cannot be performed while the reset 2 input is ON.
Twin counter	<ul style="list-style-type: none"> Resets the CP2 present value.

• The following table shows the delay from when the reset signal is input until the output is turned OFF. (Reference values)

Minimum reset signal width	Output delay time	
	Relay output	Transistor output
1 ms	3.7 to 6.6 ms	0.58 to 0.78 ms
20 ms	17.0 to 19.8 ms	13.7 to 17.2 ms

Operating Procedures (Tachometer Function)

Inputs	CP1, CP2	Reads counting signals. (The CP2 input can be used when the input mode is not 1-input mode.)
	Reset 1/reset 2	<ul style="list-style-type: none"> Holds the measurement value and outputs. (The reset 2 input can be used when the input mode is 2-input independent measurement.) Functions as a hold input. The measurement value (displayed value) and the outputs are held while the RST Key on the front panel is pressed. The hold indicator is lit when the value is being hold.
Outputs	OUT1, OUT2	Outputs signals according to the specified output mode when a set value is reached.

Connections

Terminal Arrangement

Confirm that the power supply meets specifications before use.

H7CC-A11/-A11D	H7CC-A11S/-A11SD	H7CC-A8/-A8D
<p>1-stage Contact Output</p>	<p>1-stage Transistor Output</p>	<p>1-stage Contact Output</p>
<p>H7CC-A/H7CC-AD</p> <p>1-stage Contact Output</p>	<p>H7CC-AS/-ASD</p> <p>1-stage Transistor Output</p>	
<p>H7CC-AW/-AWD/-AU/-AUD</p> <p>2-stage Contact Output</p> <p>*1: H7CC-AU</p> <p>*2: OUT1 and OUT2 are switchable by allocation change</p>	<p>H7CC-AWS/-AWS</p> <p>2-stage Transistor Output</p> <p>*2: OUT1 and OUT2 are switchable by allocation change</p>	

Transistor Output

- The transistor output of the H7CC is isolated from the internal circuitry by a photocoupler, so the transistor output can be used as both NPN and PNP output.

NPN Output

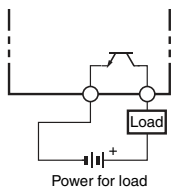

PNP Output

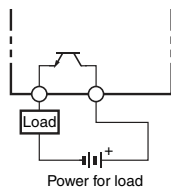

- The diode connected to the collector of the output transistor is used to absorb inverted voltage that is generated when an inductive load is connected to the H7CC.

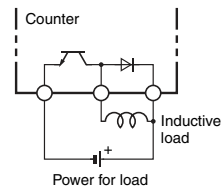

Block Diagram

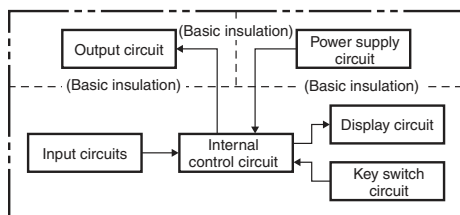

Input Circuits

CP1, CP2, Reset/Reset 1, and Total Reset/Reset 2 Input

No-voltage Inputs (NPN Inputs)

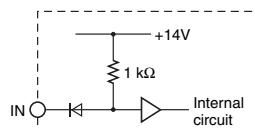

Voltage Inputs (PNP Inputs)

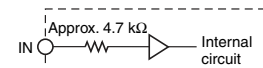

Input Connections

The inputs of the H7CC are no-voltage (short-circuit or open) inputs or voltage inputs.

No-voltage Inputs (NPN Inputs)

Open Collector

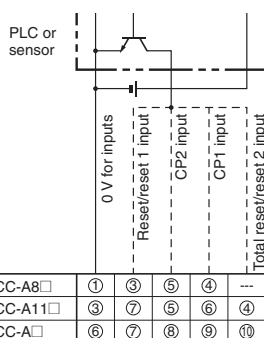

Note: Operates with transistor ON.

Voltage Output

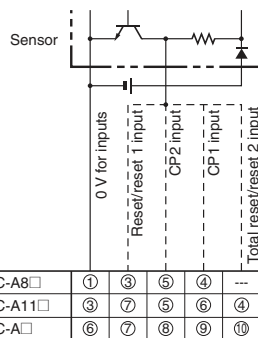

Note: Operates with transistor ON.

Contact Input

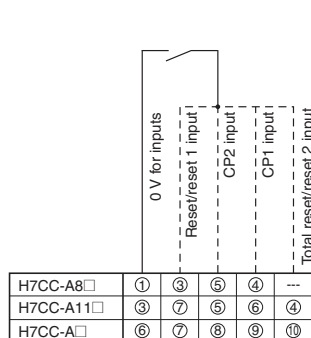

Note: Operates with relay ON.

DC Two-wire Sensor

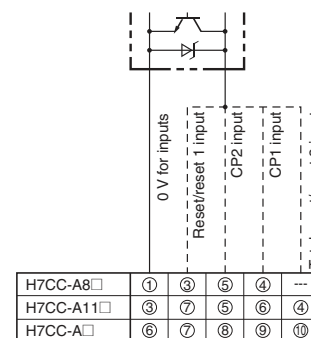

Note: Operates with transistor ON.

No-voltage Input Signal Levels

No-contact input	Short-circuit level (transistor ON)
	<ul style="list-style-type: none"> Residual voltage: 3 V max. Impedance when ON: 1 kΩ max. (The leakage current is approx. 12 mA when the impedance is 0 Ω.)
Contact input	Open level (transistor OFF)
	<ul style="list-style-type: none"> Impedance when OFF: 100 kΩ min.

Note: The DC voltage must be 30 VDC max.

Applicable Two-wire Sensor
<ul style="list-style-type: none"> Leakage current: 1.5 mA max. Switching capacity: 5 mA min. Residual voltage: 3 VDC max. Operating voltage: 10 VDC

Voltage Inputs (PNP Inputs)

No-contact Input (NPN Transistor)

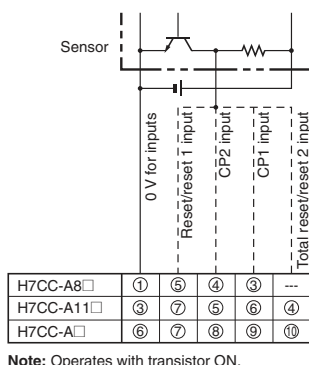

Note: Operates with transistor ON.

No-contact Input (PNP Transistor)

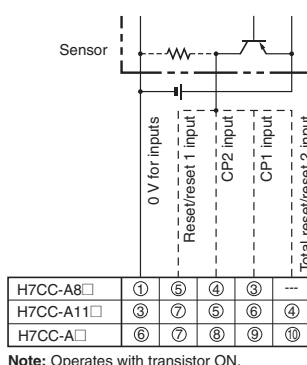

Note: Operates with transistor ON.

Contact Input

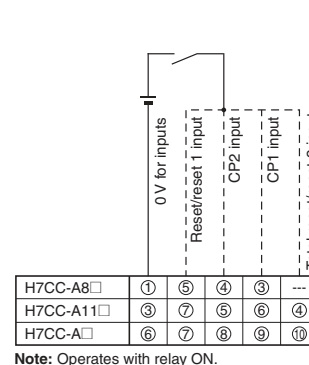

Note: Operates with relay ON.

Voltage Input Signal Levels

High level (input ON): 4.5 to 30 VDC

Low level (input OFF): 0 to 2 VDC

Note: 1. The DC voltage must be 30 VDC max.
2. Input resistance: Approx. 4.7 kΩ

Nomenclature

Display Section

- 1. Key Protect Indicator** (yellow)
- 2. Control Output Indicator** (yellow)
OUT: (One-stage)
OUT: 1 2 (Two-stage)
- 3. Reset Indicator** (yellow)
(Lit when the reset input (1) is ON or reset operation is performed.)
Displayed only when the configuration selection mode is not tachometer mode.
- 4. Total Count Indicator**
(Lit when the total count value is displayed.)
- 5. Batch Indicator**
(Lit when the batch count value is displayed.)
- 6. Set Value 1, 2 Stage Indicator**
- 7. Present Value (Main Display)**
(Character height: 10 mm, white *)
- 8. Set value (Sub-display)**
(Character height: 6 mm, green)
- 9. Hold Display (yellow)**
Displayed only when the configuration selection mode is not tachometer mode.

Model with 6 Digits

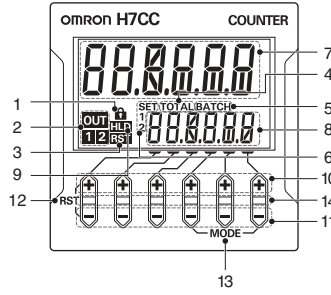
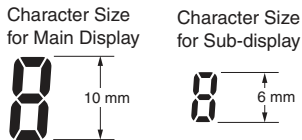

Operation Keys

- 10. Up Keys (UP1 to UP6)**
(UP1, 2, 3, 4, 5, 6 from right to left)
- 11. Down Keys (DW1 to DW6)**
(DW1, 2, 3, 4, 5, 6 from right to left)
- 12. Reset Operation (UP6+DW6) ***
(The reset operation is enabled by pressing and holding the keys for 1 second or longer. When the keys are pressed simultaneously, all status indicators start blinking. The reset operation is disabled if the keys are released within 1 second.)
To perform the reset operation, firmly press and hold both UP6 and DW6. If you press only UP6 or DW6, the set value will change.
- 13. Mode Operation (UP1+UP3 or DW1+DW3)**
(Changes modes and setting items. Press and hold the keys for 2 seconds or longer to move to the function setting mode. When the keys are pressed simultaneously, the status indicators on UP1 (DW1) and UP3 (DW3) start blinking.
The mode operation is disabled if the keys are released within 2 seconds.)
- 14. Status indicator**
<When Run mode is not selected.>
 - When the indicator display mode is ON
When used as a counter, the ratio of the present value to the set value is displayed from 0 to 100%.
When used as a tachometer, if "Upper and lower limit" or "Area" is selected in the tachometer output mode, the ratio of the measurement value to the comparison value is displayed from 0 to 100%.
 - When the indicator display mode is all off or all lit
All off or all lit display.**Note.** When you press the Up Key or the Down Key, the status indicator display goes off, and the pressed key lights up or blinks.
<When Function Setting Mode is not selected>
 - The keys that can be set light up for notification.

Switches

15. Key-protect Switch

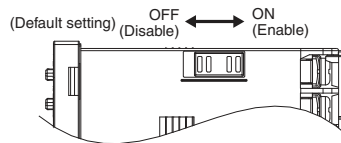

Note: The reset functions depends on the selected configuration.

Configuration	Reset operation *
1-stage/2-stage preset counter	Resets the present value and outputs.
Total and preset counter	<ul style="list-style-type: none"> • Resets the present value and outputs. • When the total count value is displayed, resets the present value, the total count value, and outputs.
Batch counter	<ul style="list-style-type: none"> • Resets the present value and OUT2. • When the batch count value is displayed, resets the present value, the batch count value, and outputs.
Dual counter	Resets the CP1 present value, CP2 present value, dual count value, and outputs.
Twin counter	Resets the CP1 present value and output 1 when the CP1 present value is displayed. Resets the CP2 present value and output 2 when the CP2 present value is displayed.
Tachometer	Holds the measurement value and outputs (hold function). (When the input mode is 2-input independent measurement, the CP1 measurement value display will hold the CP1 measurement value and output 1 and the CP2 measurement value display will hold the CP2 measurement value and output 2.)

Dimensions

Counters

H7CC-A/-AS/-AW/-AWS/-AWD/-AWSD/-AU/-AUD (Flush Mounting Models)

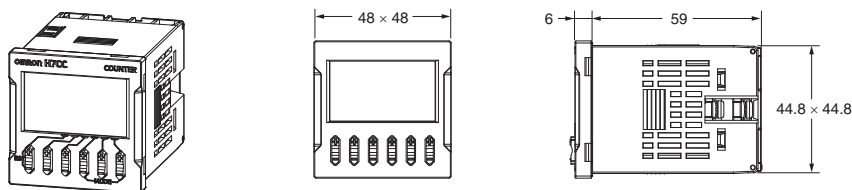

Note: M3.5 terminal screw (effective length: 6 mm)

H7CC-A8/-A8D (Flush Mounting/Surface Mounting Models)

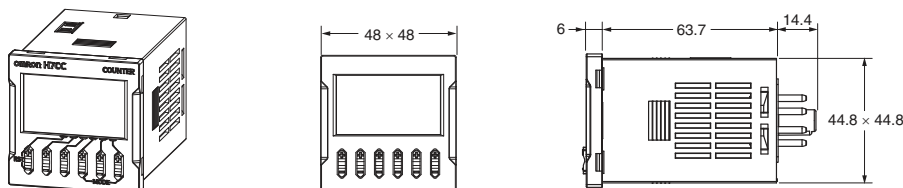

H7CC-A11/-A11S/-A11D/-A11SD (Flush Mounting/Surface Mounting Models)

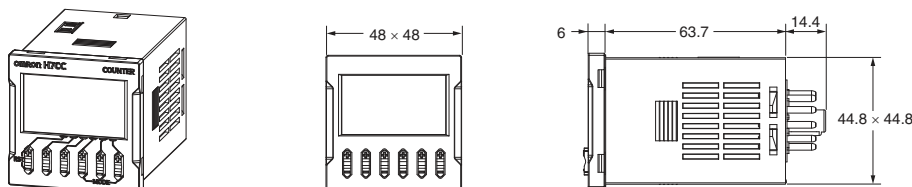

Dimensions with Flush Mounting Adapter

H7CC-A/-AS/-AW/-AWS/-AWD/-AWSD/-AU/-AUD (Provided with Adapter and Waterproof packing)

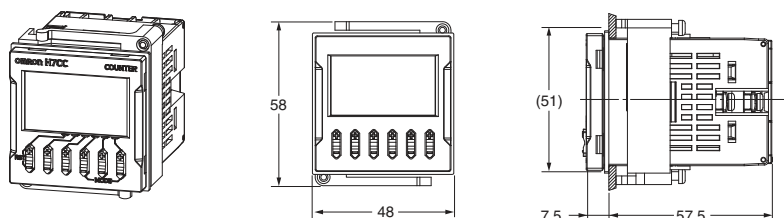

Panel Cutouts

Panel cutouts are as shown below. (according to DIN43700).

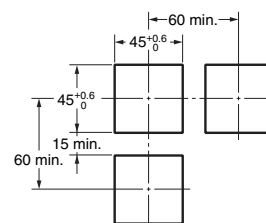

- Note:
1. The mounting panel thickness should be 1 to 5 mm.
 2. To allow easier operation, it is recommended that Adapters be mounted so that the gap between sides with hooks is at least 15 mm (i.e., with the panel cutouts separated by at least 60 mm).
 3. It is possible to horizontally mount Timers side by side. Attach the Flush Mounting Adapters so that the surfaces without hooks are on the sides of the Timers. If they are mounted side-by-side, water-resistance will be lost.

H7CC-A8/-A8D/-A11/-A11S/-A11D/-A11SD (Flush Mounting/Surface Mounting Models) (Adapter and Waterproof packing Ordered Separately)

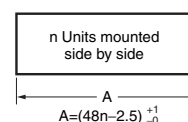
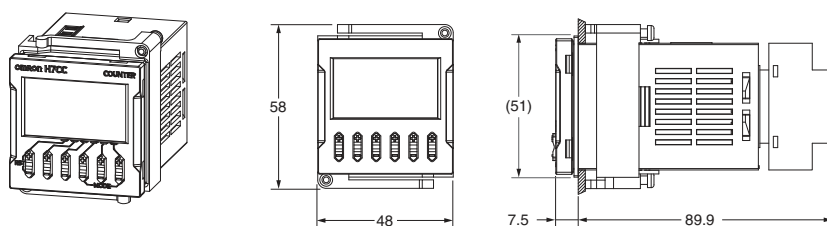

With Y92A-48F1 attached.

$$A = \{48n - 2.5 + (n-1) \times 4\} \begin{smallmatrix} +1 \\ -0 \end{smallmatrix}$$

With Y92A-48 attached.

$$A = \{51n - 5.5\} \begin{smallmatrix} +1 \\ -0 \end{smallmatrix}$$

Dimensions with Front Connecting Socket

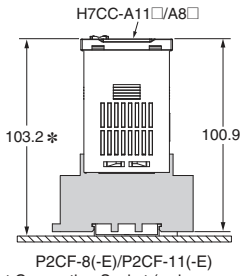

P2CF-8(-E)/P2CF-11(-E)
Front Connecting Socket (order separately)

* These dimensions depend on the kind of DIN track and Sockets. (Reference value.)

Accessories (Order Separately)

Note: Depending on the operating environment, the condition of resin products may deteriorate, and may shrink or become harder. Therefore, it is recommended that resin products are replaced regularly.

Soft Cover Y92A-48F1

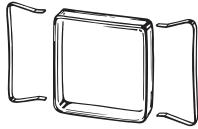

Hard Cover Y92A-48

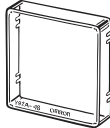

Protecting the Counter/Tachometer in Environments Subject to Oil

The H7CC's panel surface is water-resistant (conforming to IP□6) and so even if drops of water penetrate the gaps between the keys, there will be no adverse effect on internal circuits. If, however, there is a possibility of oil being present on the operator's hands, use the Soft Cover. The Soft Cover ensures protection equivalent to IP54F against oil. Do not, however, use the H7CC in locations where it would come in direct contact with oil.

Waterproof Packing Y92S-29

Note: The Waterproof Packing is included with models with screw terminals.

Order the Waterproof Packing separately if it is lost or damaged. The Waterproof Packing can be used to achieve IP66 protection.

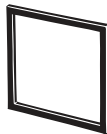

The panel surface of the H7CC-A/-R is water-resistant (conforming to IP66). To protect the internal circuits from water penetration through the space between the H7CC and operating panel, waterproof packing is included. Attach the Y92F-30 Adapter with sufficient pressure with the reinforcing screws so that water does not penetrate the panel.

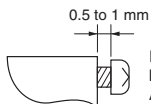

It is recommended that the space between the screw head and the Adapter be 0.5 to 1 mm.

The Waterproof Packing will deteriorate, harden, and shrink depending on the application environment. To ensure maintaining the IP□6 waterproof level, periodically replace the Waterproof Packing. The periodic replacement time will depend on the application environment. You must confirm the proper replacement time. Use 1 year or less as a guideline. If the Waterproof Packing is not replaced periodically, the waterproof level will not be maintained. It is not necessary to mount the Waterproof Packing if waterproof construction is not required.

Flush Mounting Adapter Y92F-30

Order the Flush Mounting Adapter with the following model number separately if it is lost or damaged.

Note: The Waterproof Packing is included with models with screw terminals.

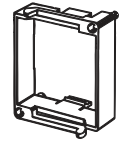

Y92F-45

Note: 1. The adapter is black in color.

2. The Y92F-45 can be used in combination with the Y92F-30 Adapter provided with the Counter.

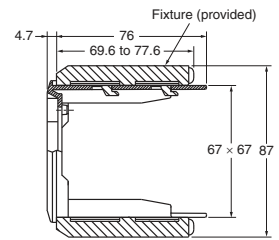
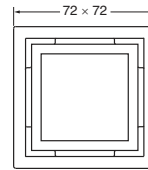
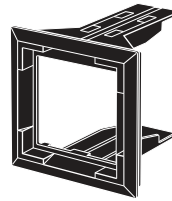

<H7CC Mounting Example>

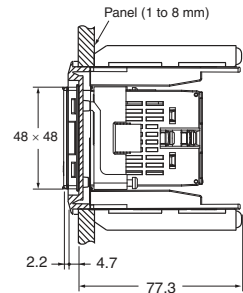
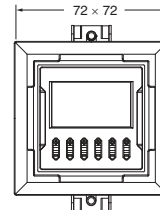
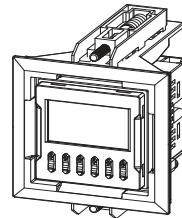

Connection Sockets Front Connecting Socket

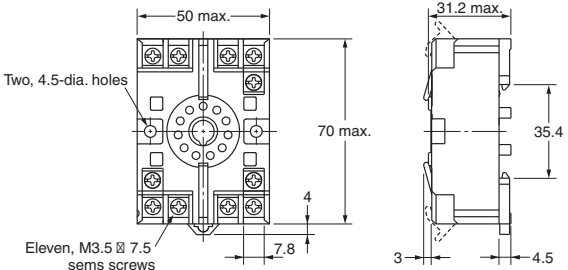
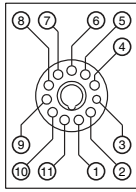
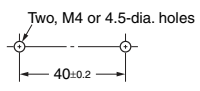
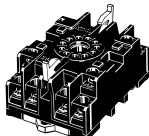
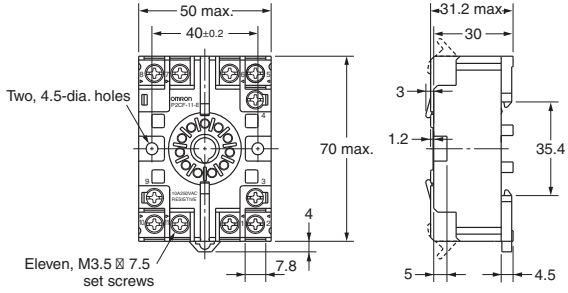
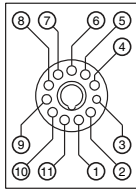
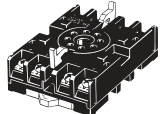
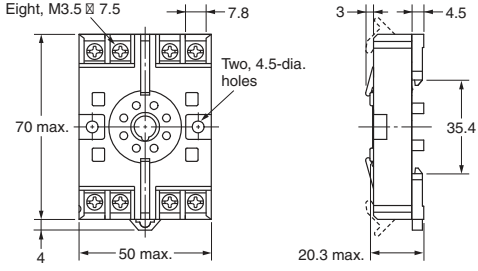
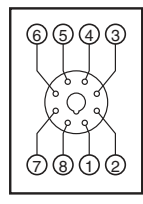
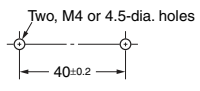
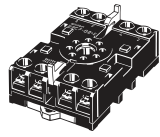
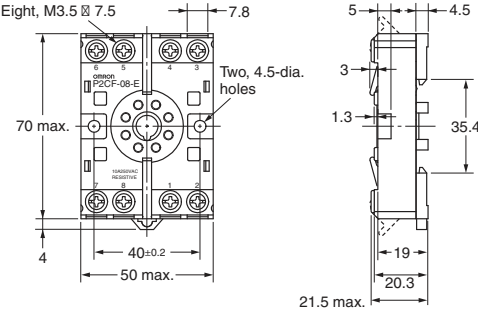
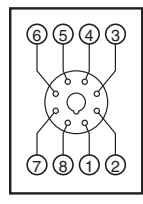
Model	Dimensions	Terminal arrangement and internal connections	Mounting hole dimensions
P2CF-11 			 <p>Two, M4 or 4.5-dia. holes 40±0.2</p>
P2CF-11-E (Finger-safe Type) 		 <p>(Top View)</p>	<p>Note: The Socket can also be mounted to DIN track.</p>
P2CF-08 			 <p>Two, M4 or 4.5-dia. holes 40±0.2</p>
P2CF-08-E (Finger-safe Type) 		 <p>(Top View)</p>	<p>Note: The Socket can also be mounted to DIN track.</p>

Note: Round crimp terminals cannot be used on Finger-safe Sockets. Use forked crimp terminals.

Back-connecting Sockets

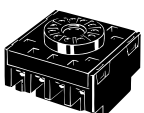
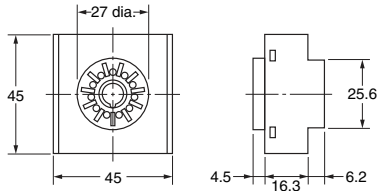
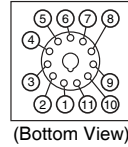
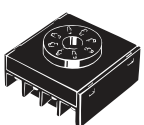
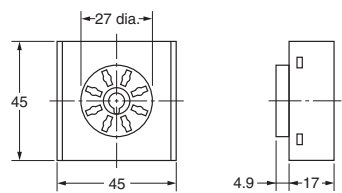
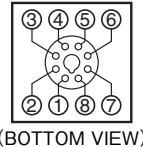
Model	Dimensions	Terminal arrangement and internal connections
P3GA-11 		 <p>(Bottom View)</p>
P3GA-08 		 <p>(BOTTOM VIEW)</p>

Note: A Y92A-48G Terminal Cover can be used with the Socket to create a finger-safe construction.

Terminal Covers for P3GA-08/P3GA-11 Back-connecting Socket

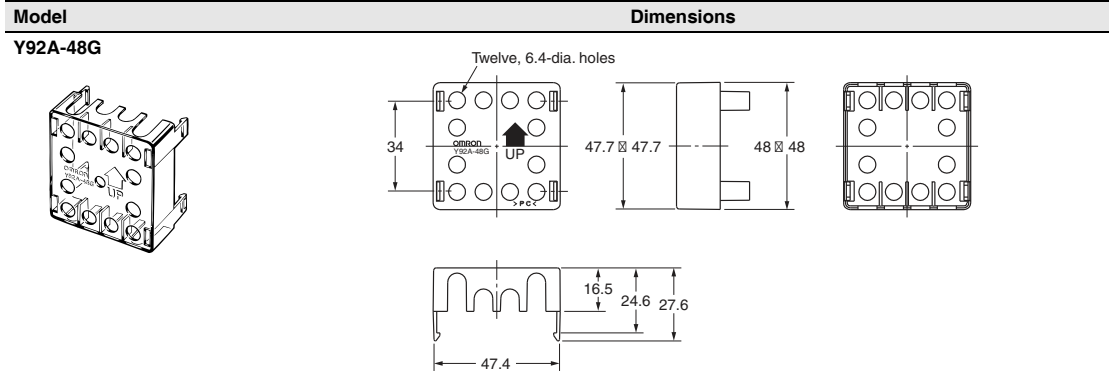

Note: The Terminal Cover can be used with a Back-mounting Socket (P3GA-11) to create a finger-safe construction.

Optional Products for Track Mounting

Mounting Track

PFP-100N
PFP-50N

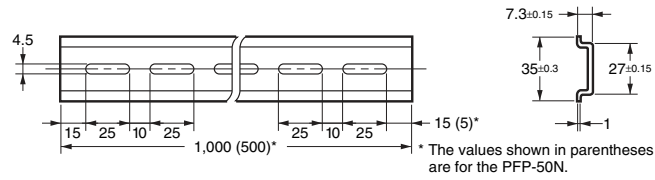
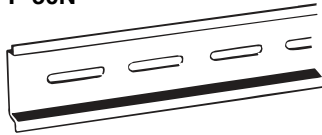

Mounting Track

PFP-100N2

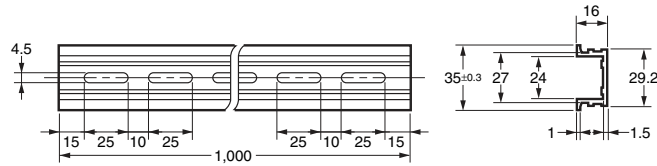
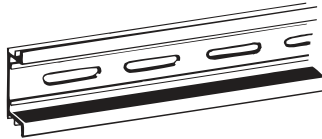

End Plate

PFP-M

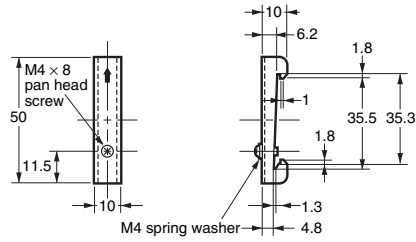

Spacer

PFP-S

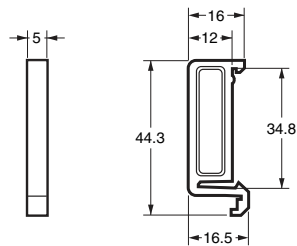
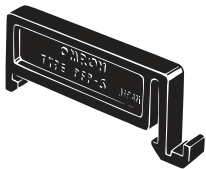

Note: Order Spacers in increments of 10.

Operating Procedures

Setting Procedure Guide

Setting for Counter Operation *

Use the following settings.

Setting for Tachometer Operation *

Refer to page 31.

* At the time of delivery, the H7CC is set to the 1-stage preset counter configuration or 2-stage preset counter configuration. Refer to page 39 for information on switching models.

I/O Functions for Counter Operation

Step 1

The H7CC-A□ is a Counter that contains more than one functional counter.
When using the Counter in any mode other than the default mode *, use the following chart to enter Configuration Selection Mode and set the functions that are suitable to the application.

* Table Default Modes and Selectable Functions

Model	Default mode	Selectable mode
H7CC-AW	2-stage preset counter	Any mode
H7CC-AU	1-stage preset counter	Any mode
Other models	1-stage preset counter	1-stage preset or total preset counter only

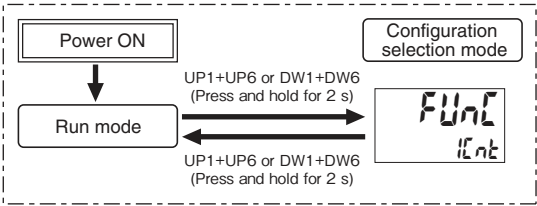

Select the function from Table using the UP1 Key (DW1 Key).

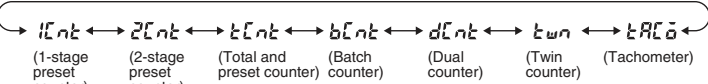

Note: The modes that can be selected depend on the model. (Refer to the Table.)

Step 2

Parameters are set with the operation keys on the front panel.

Change to Function Setting Mode.

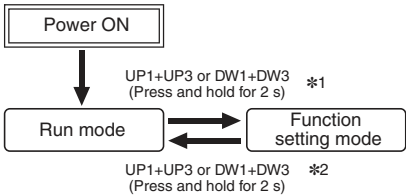

For details on operations and display in run mode, refer to page 21. The display depends on the selected configuration.

- *1 If the mode is switched to the function setting mode during operation, operation will continue.
- *2 Changes made to settings in function setting mode are enabled for the first time when the mode is changed to run mode. Also, when settings are changed, the counter is reset (present value initialized and output turned OFF) on returning to run mode.

The characters displayed in reverse video are the default settings. In the function setting mode, the status indicator of the keys that can be set lights up.

(Example) In the case of the prescale value (PSCL)
A value from 0.001 to 99.999 can be set, and therefore, the status indicator of the UP1 Key (DW1 Key to DW5 Key) lights up.

* Use UP1+UP3 to move up and DW1+DW3 to move down

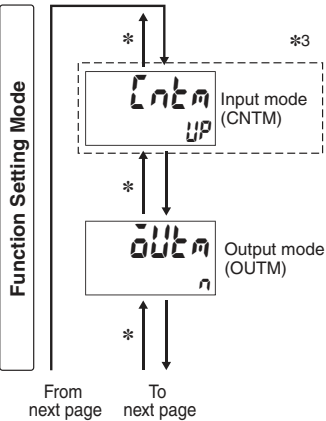
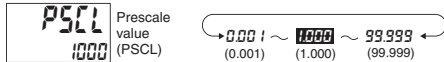

• Set the input mode using the UP1 Key (DW1 Key).

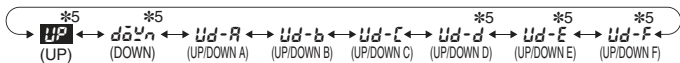

Note: Displayed only when Twin Counter Mode is not selected.
*5 Displayed for output modes other than K-2, D, L, and H only.

• Set the output mode using the UP1 Key (DW1 Key).

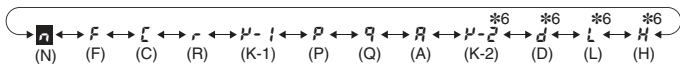

*6. μ-2, d, L and H are displayed only when the H7AN compatibility function is OFF or the input mode is Ud-A, Ud-b, or Ud-c.
(Not displayed when the function is set to tōn.)
H is displayed only for 2-stage models.

*3 When Using Dual Counter Operation

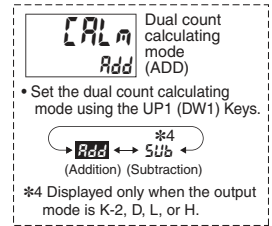

Usage as a Decrementing Counter (Sub)
The Sub parameter is normally not displayed. You must set the dōtōn parameter shown below in advance to *6 (μ-2, d, L, or H) to display it.

To previous page
From previous page

From next page
To next page

Function Setting Mode

* Use UP1+UP3 to move up and DW1+DW3 to move down

*7

*7

0.50

0.50

Output time (OTIM)

*7

30Hz

30Hz

Counting speed (CNTS)

*7

20ms

20ms

Reset input signal width (IFLT)

*7

dp

dp

Decimal point position (DP)

*7

1.000

1.000

Prescale value (PSCL)

*7

nPN

nPN

NPN/PNP input mode (IMOD)

*7

ABS

ABS

Absolute value setting/forecast value setting (SETM)

*7

SL-H

999999

Set value upper limit (SL-H)

*7

PL-H

!

Forecast setting upper limit (PL-H)

*7

BL-H

999999

Batch count upper limit (BL-H)

*7 Set each digit using the individual UP1 to UP4 Keys (DW1 to DW4 Keys).

0.01 ~ 0.50 ~ 99.99
(0.01 s) (0.50 s) (99.99 s)

Note: Displayed only when the output mode is C, R, K-1, P, Q, A, or K-2.

*7 Set the counting speed using the UP1 Key (DW1 Key).

30Hz ↔ 5kHz
(30 Hz) (5 kHz) *

* The display shows 5 kHz, but the maximum counting speed is 10 kHz.

*7 Set the Reset input signal width using the UP1 Key (DW1 Key).

20ms ↔ 1ms
(20 ms) (1 ms)

*7 Set the decimal point position using the UP1 Key (DW1 Key).

(No decimal point) (One digit after decimal point) (Two digits after decimal point) (Three digits after decimal point)

Note: Not displayed when the H7AN compatibility function is ON.

*7 Set each digit using the individual UP1 Key (DW1 Key).

0.001 ~ 1.000 ~ 99.999
(0.001) (1.000) (99.999)

Note: Not displayed when the H7AN compatibility function is ON.

*7 Set the NPN/PNP input mode using the UP1 Key (DW1 Key).

nPN ↔ PnP
(NPN input) (PNP input)

*7 Make the absolute value setting and forecast setting using the UP1 Key (DW1 Key).

ABS ↔ OFST
(ABS) (OFST)

Note: Displayed only when the configuration selection mode is set to the 2-stage counter 2CNT.

*7 Set each digit using the individual UP1 to UP6 Keys (DW1 to DW6 Keys).

! ↔ 999999
(1) (999999)

*7 Set each digit using the individual UP1 to UP6 Keys (DW1 to DW6 Keys).

! ↔ 999999
(1) (999999)

Note: Displayed only when the configuration selection mode is set to the 2-stage counter 2CNT and there is a forecast value setting.

*7 Set each digit using the individual UP1 to UP6 Keys (DW1 to DW6 Keys).

! ↔ 999999
(1) (999999)

Note: Displayed only when the output mode is bCNT.

*7 Set each digit using the individual UP1 to UP4 Keys (DW1 to DW4 Keys).

When using as a 2-stage preset counter

*7

0.50

0.50

One-shot output 2 time (OTM2)

0.01 ~ 0.50 ~ 99.99
(0.01 s) (0.50 s) (99.99 s)

Note: Displayed only when the output mode is C, R, K-1, P, Q, A, or K-2.

*7

Hold

Hold

One-shot output 1 time (OTM1)

Hold/0.01 ~ 99.99
(Outputs held) (0.01 s) (99.99 s)

If the output time is 0.00, Hold is displayed.

Note: Displayed for output modes other than D, L, and H. HOLD cannot be set when the output mode is K-2.

When using as a batch counter

*7

0.50

0.50

One-shot output 2 time (OTM2)

0.01 ~ 0.50 ~ 99.99
(0.01 s) (0.50 s) (99.99 s)

Note: Displayed only when the output mode is C, R, K-1, P, Q, A, or K-2.

*7 Set each digit using the individual UP1 to UP4 Keys (DW1 to DW4 Keys).

Twin Counter

*7

0.50

0.50

Output 2 output time (OTM2)

0.01 ~ 0.50 ~ 99.99
(0.01 s) (0.50 s) (99.99 s)

Note: Displayed only when the output mode is C, R, K-1, P, Q, or A.

*7

0.50

0.50

Output 1 output time (OTM1)

0.01 ~ 0.50 ~ 99.99
(0.01 s) (0.50 s) (99.99 s)

Note: Displayed only when the output mode is C, R, K-1, P, Q, or A.

To previous page
From previous page

* Use UP1+UP3 to move up and DW1+DW3 to move down



Output allocation (OTST)

• Set the output allocation using the UP1 Key (DW1 Key).

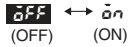

Note: Displayed only when the 2-stage preset counter, batch counter, or twin counter is selected in the H7CC-□W(U)□.

OFF: Output 1 (OUT1) = 12, 13 Output 2 (OUT2) = 3, 4, 5/
ON: Output 1 (OUT1) = 3, 4, 5 Output 2 (OUT2) = 12, 13 (The numbers are the terminals numbers.)



Key protect level (KYPT)

• Set the key protect level using the UP1 Key (DW1 Key).

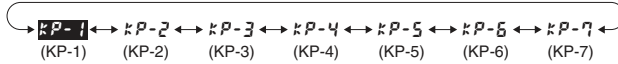

Output inversion

*8 Set the output inversion using the UP1 Key (DW1 Key).

Procedure for Models Other than "□W(U)□" Models

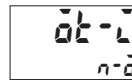

Output inversion (OT-I)

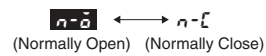

Procedure for "□W(U)□" Models



Output 1 (OUT1) inversion (OT1I)

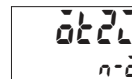
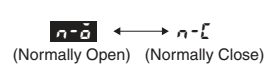

Output 2 (OUT2) inversion (OT2I)

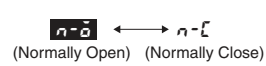

Function Setting Mode



Memory back up (BKUP)

• Set the memory backup using the UP1 Key (DW1 Key).

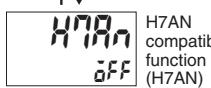
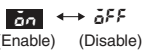

H7AN compatibility function (H7AN)

• Set the H7AN compatibility function using the UP1 Key (DW1 Key).

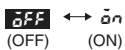

(When the function is set to ON, the count will shift from 0 to 999999.)

Note: Disable the H7AN compatibility function when converting from the H7CX or H7CX-N.



Indicator display mode (INDC)

• Set the indicator display mode using the UP1 Key (DW1 Key).

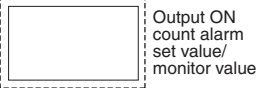
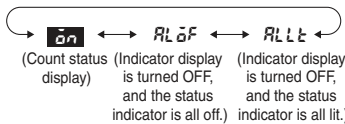

Output ON count alarm set value/monitor value

*9 Set each digit using the individual UP1 to UP4 Keys (DW1 to DW4 Keys).

Procedure for Models Other than "□W(U)□" Models



Output ON count alarm set value (ON-A)

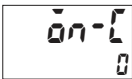

Output ON count monitor value (ON-C)

Note: The monitor value is only displayed. It cannot be set.

Procedure for "□W(U)□" Models

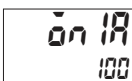

Output 1 (OUT1) ON count alarm set value (ON1A)

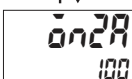
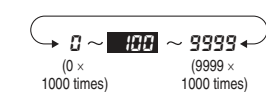

Output 2 (OUT2) ON count alarm set value (ON2A)

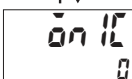

Output 1 (OUT1) ON count monitor value (ON1C)

Note: The monitor value is only displayed. It cannot be set.

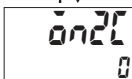

Output 2 (OUT2) ON count monitor value (ON2C)

Note: The monitor value is only displayed. It cannot be set.

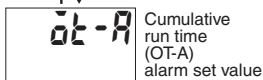

Cumulative run time (OT-A) alarm set value

• Set each digit using the individual UP1 to UP3 Keys (DW1 to DW3 Keys).

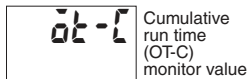

Cumulative run time (OT-C) monitor value

Note: The monitor value is only displayed. It cannot be set.

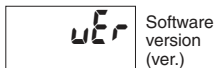

Software version (ver.)

Note: The monitor value is only displayed. It cannot be set.

Explanation of Functions I/O Functions for Counter Operation

Input Mode (入力モード)

Set increment mode (UP), decrement mode (DOWN), or one of the increment/decrement modes (UP/DOWN A, UP/DOWN B, or UP/DOWN C, UP/DOWN D, UP/DOWN E, or UP/DOWN F) as the input mode.

(For details on the operation of the input modes, refer to *Input Modes and Present Value* on page 22.)

Dual Count Calculating Mode (計算モード)

When using as a dual counter, select either ADD (addition) or SUB (subtraction) as the calculation method for the dual count value.

ADD: Dual count value = CP1 PV + CP2 PV

SUB: Dual count value = CP1 PV – CP2 PV

Output Mode (出力モード)

Set the way that control output for the present value is output. The possible settings are N, F, C, R, K-1, P, Q, A, K-2, D, L, and H. The output modes that can be set vary with the model.

(For details on the operation of the output modes, refer to *Input/Output Mode Settings* on page 24.)

One-shot Output Time (出力時間)

Set the one-shot output time (0.01 to 99.99 s) for control output.

One-shot output can be used only when C, R, K-1, P, Q, A, or K-2 is selected as the output mode.

One-shot Output 2 Time (出力時間2)

Set the one-shot output time (0.01 to 99.99 s) for control output (OUT2).

One-shot output can be used only when C, R, K-1, P, Q, A, or K-2 is selected as the output mode.

One-shot Output 1 Time (出力時間1)

Set the one-shot output time (0.01 to 99.99 s) for control output (OUT1).

One-shot output can be used only when the mode other than D, L, and H is selected as the output mode.

If the output time is set to 0.00, **Hold** is displayed, and outputs are held.

Counting Speed (カウントスピード)

Set the maximum counting speed (30 Hz/5 kHz) for CP1 and CP2 inputs together.

If contacts are used for input signals, set the counting speed to 30 Hz. Processing to eliminate chattering is performed for this setting.

Reset Input Signal Width (リセット入力パルス幅)

Set the reset input signal width (20 ms/1 ms) for reset/reset 1 and total reset/reset 2 inputs together.

If contacts are used for the input signal, set the input signal width to 20 ms. Processing to eliminate chattering is performed for this setting.

Decimal Point Position (小数点位置)

Decide the decimal point position for the present value, CP1/CP2 present values, set value (SV1, SV2), total count value, and dual count set value.

Prescale Value (プリスケール)

Pulses input to the counter are converted according to the specified prescale value.

(Setting range: 0.001 to 99.999)

Example: To display the feed distance for systems that output 25 pulses for a feed length of 0.5 m in the form □□.□□ m:

1. Set the decimal point position to 2 decimal places.
2. Set the prescale value to 0.02 (0.5 ÷ 25).

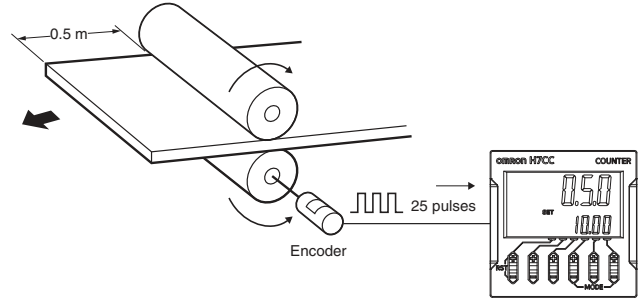

- Observe the following points when setting a prescale value. Set the set value to a value less than {Maximum countable value – Prescale value}.
Example: If the prescale value is 1.25 and the counting range is 0.000 to 999.999, set the set value to a value less than 998.749 (= 999.999 – 1.25).
If the set value is set to a value greater than this, output will not turn ON.
- Output will turn ON, however, if a present value overflow occurs (FFFFFF).

Note: If the prescale value setting is incorrect, a counting error will occur. Check that the settings are correct before using this function.

NPN/PNP Input Mode (入力モード)

Select either NPN input (no-voltage input) or PNP input (voltage input) as the input format. When using a two-wire sensor, select NPN input.

The same setting is used for all external inputs.

For details on input connections, refer to *Input Connections* on page 9.

Absolute Value Setting/Forecast Value Setting (5E5)

For the 2 count output mode, an absolute value setting (Rb5) or forecast value setting (5F5E) can be set for set value 1. If the absolute value setting is used, specify an absolute value (deviation from 0).

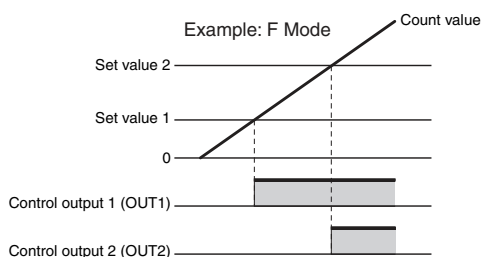

If the forecast value setting is used, specify set value 1 as the forecast set value (deviation with respect to set value 2).

The forecast output (output 1) turns ON when the present value reaches the forecast value.

If the forecast set value is greater than or equal to the set value, the forecast output (output 1) will turn ON as soon as counting starts.

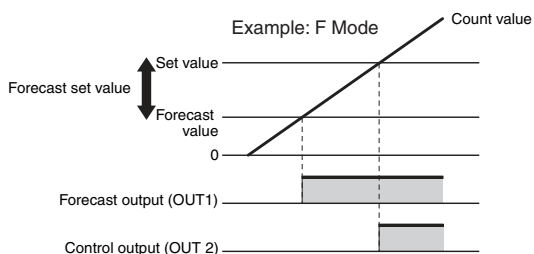

Set Value Upper Limit (5L-H)

Set the upper limit for the set value when it is set in run mode. The setting can be made from 1 to 999999 for 6-digit models.

Forecast Set Upper Limit (FL-H)

Set the upper limit for the forecast set value. The setting can be made from 1 to 999999 for 6-digit models.

Batch Count Upper Limit (bL-H)

Set the upper limit for the batch count value. The setting can be made from 1 to 999999 for 6-digit models.

Key Protect Level (K-SP)

Set the key protect level. Refer to *Key Protect Level* on page 40.

Output ON Count Alarm Set Value (5n-R, 5n-IR, 5n2R)

The output ON count for notifying the replacement time can be set. For details, refer to page 41.

Output ON Count Monitor Value (5n-L)

The monitor value is only displayed. It cannot be set. The output ON count will be 1,000 times the displayed value.

ON Count Monitor Values for Outputs 1 and 2 (OUT1 and OUT2) (5n-IL and 5n2IL)

The monitor value for output 1 and 2 (OUT1 and OUT2) is only displayed. It cannot be set. The output ON count will be 1,000 times the displayed value.

Output Allocation (Settings applicable to only H7CC-□W(U)□) (5E5E)

Set the allocation of outputs 1 and 2 (OUT1 and OUT2). If output allocation is OFF, output 1 (OUT1) is allocated to terminals (12) and (13), and output 2 (OUT2) is allocated to terminals (3), (4), and (5). If output allocation is ON, output 1 (OUT1) is allocated to terminals (3), (4), and (5), and output 2 (OUT2) is allocated to terminals (12) and (13).

Output inversion (5E-L, 5E-IL, 5E2L)

Set logical inversion of output ON/OFF. In the case of two outputs, it is possible to individually set output inversion for each of output 1 and output 2 (OUT1 and OUT2). If output inversion is n-O (Normally Open), the output turns ON when the set value is reached. If output inversion is n-C (Normally close), the output turns OFF when the set value is reached.

Memory back up (bMUP)

Set the present value and the output state memory backup. If memory backup is available, the present value and output state are recovered to the state prior to power interruption. If memory backup is not available, the present value and output state are recovered to the reset state.

H7AN Compatibility Function (H7AN)

When the present value being decremented exceeds 0, make the setting to start counting from 999999. When this function is ON, the value becomes 999999 after 0, and when this function is OFF, the count is in accordance with the output mode. The H7AN Compatibility Function is enabled only when 1-stage preset counter, 2-stage preset counter, and total and preset counter are selected, and is displayed in the function setting mode. It is not displayed when batch counter, dual counter, or twin counter are selected. This function enables the same operation when the H7AN is replaced with the H7CC.

H7CC-A□

Counter

Indicator Display Mode (̄nd̄)

Settings can be made to display the present value in status indicator. When this mode is ON, the status indicator changes in accordance with the ratio of the present value to the set value. In the case of ALOF, the indicator display is turned OFF, and the status indicator is all off. In the case of ALLT, the indicator display is turned OFF, and the status indicator is all lit.

(Example 1) When incrementing input is performed

The status indicators light up in an order starting from the left, when the status reaches 1/6, 2/6, 3/6 (50%), 4/6, 5/6, 6/6 (100%) in accordance with the ratio of the present value to the set value. Three indicators on the left light up when the status reaches 50%, and all indicators light up when the status reaches 100%. All indicators are lit even when the status is 100% or more. All indicators turn off when the value changes from 999999 to 0. If the counter continues thereafter, the status indicator will light up according to the present value.

(Example 2) When decrementing input is performed

The status indicators turn off in an order starting from the right, when the status reaches 6/6 (100%), 5/6, 4/6, 3/6 (50%), 2/6, 1/6 in accordance with the ratio of the present value to the set value. Three indicators on the right turn off when the status reaches 50%, and all indicators turn off when the status reaches 1/6. All indicators are off even when the status is below 1/6. All indicators light up when the H7AN compatibility function is ON and the value changes from 0 to 999999. If the counter continues thereafter, the status indicator will light up according to the present value.

Cumulative Run Time Alarm Set Value (̄t -R)

The cumulative run time for notifying the replacement time can be set. For details, refer to page 41.

Cumulative Run Time Monitor (̄t -L)

The cumulative run time is displayed. It is not a setting item. The numerical values are displayed in increments of 0.1 years.

Operation in Run Mode

I/O Functions for Counter Operation

- Set values for each digit as required using the UP1 to UP6 Keys (DW1 to DW6 Keys).

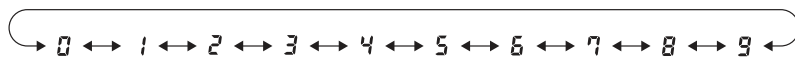

1-stage Preset Counter

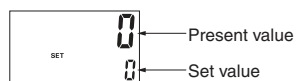

2-stage Preset Counter with Absolute Value Setting

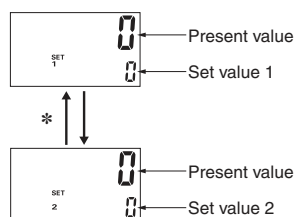

- Present Value**
Shows the present count value.
- Set Values (Set Value 1 and Set Value 2)**
Set the set values.
When the present value reaches the set value (set value 1 or set value 2), a signal is output according to the specified output mode.

2-stage Preset Counter with Forecast Value Setting

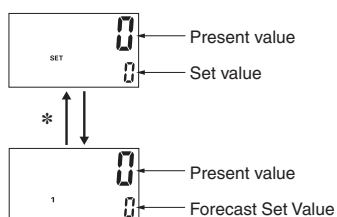

- Present Value**
Shows the present count value.
- Set Values**
Set the set values.
- Forecast Set Value**
Set the deviation for the set value.

Total and Preset Counter

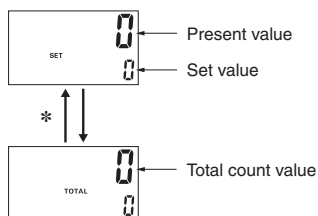

- Present Value/Set Value**
Same as 1-stage preset counter.
- Total Count Value**
Shows the present total count value.

Batch Counter

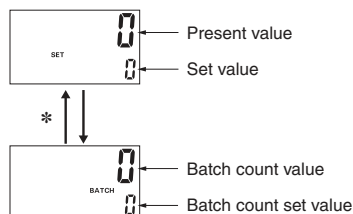

- Present Value/Set Value**
Same as 1-stage preset counter.
- Batch Count Value**
Shows the number of times the count has been completed for the present value.
- Batch Count Set Value**
Set the batch count set value.
When the batch count value reaches the batch count set value, batch output (OUT1) turns ON.

Dual Counter

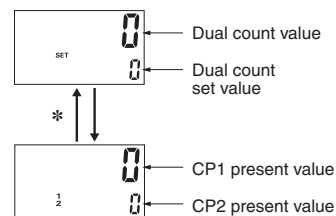

- Dual Count Value**
Shows the sum of the CP1 present value and CP2 present value when the dual count calculating mode is ADD and shows the value obtained by subtracting the CP2 present value from the CP1 present value when the dual count calculating mode is SUB.
- Dual Count Set Value**
Set the dual count set value.
When the dual count value reaches the dual count set value, signals are output according to the specified output mode.
- CP1/CP2 Present Value**
Show the present count values for CP1 and CP2 present values respectively.

Twin Counter

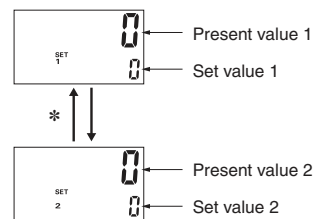

- Present Values 1 and 2**
Shows the present count value 1 or 2.
- Set Values 1 and 2**
Setting for present value 1 or 2.

* Use UP1+UP3 to move up and DW1+DW3 to move down

H7CC-A□ Counter

Input Modes and Present Value (See note 1.)

I/O Functions for Counter Operation

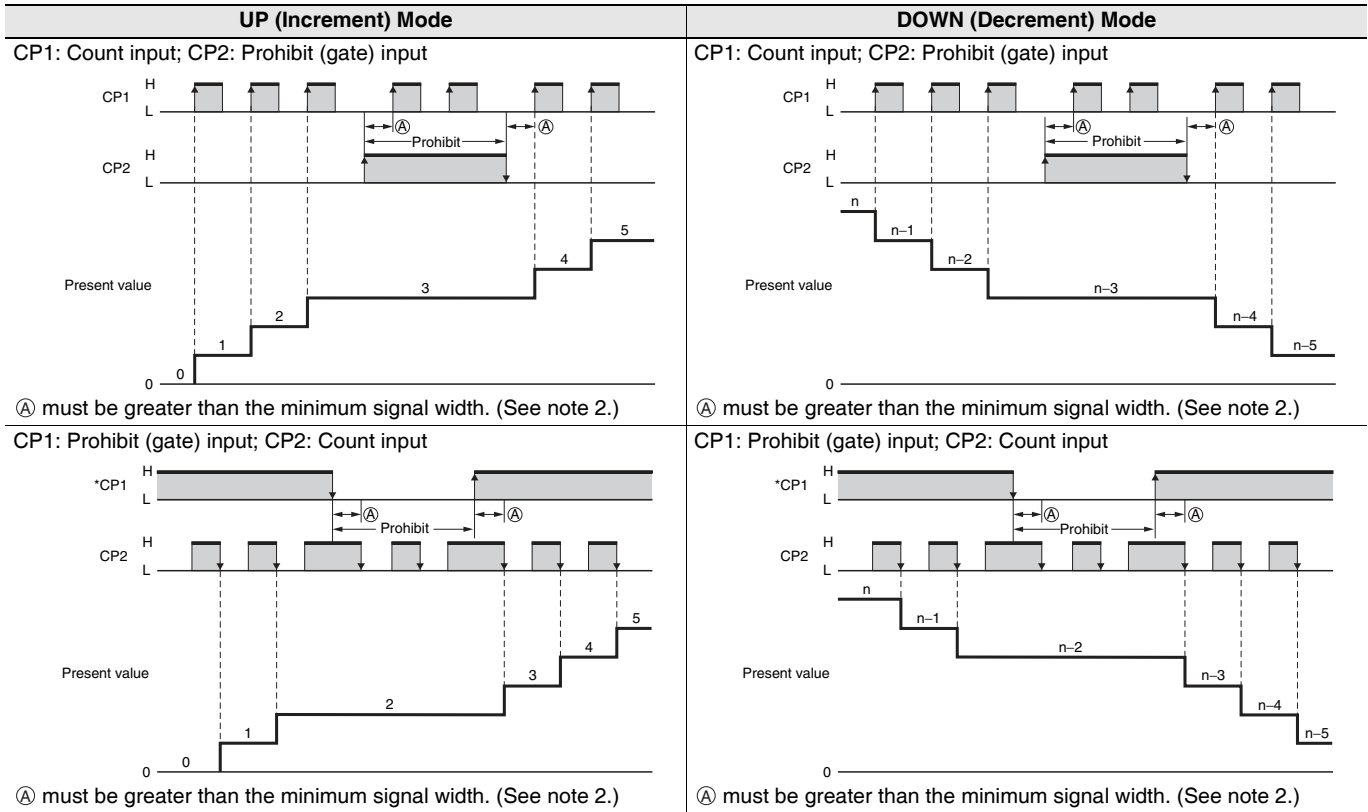

* Counting starts when the CP1 is turned ON after turning ON the power.

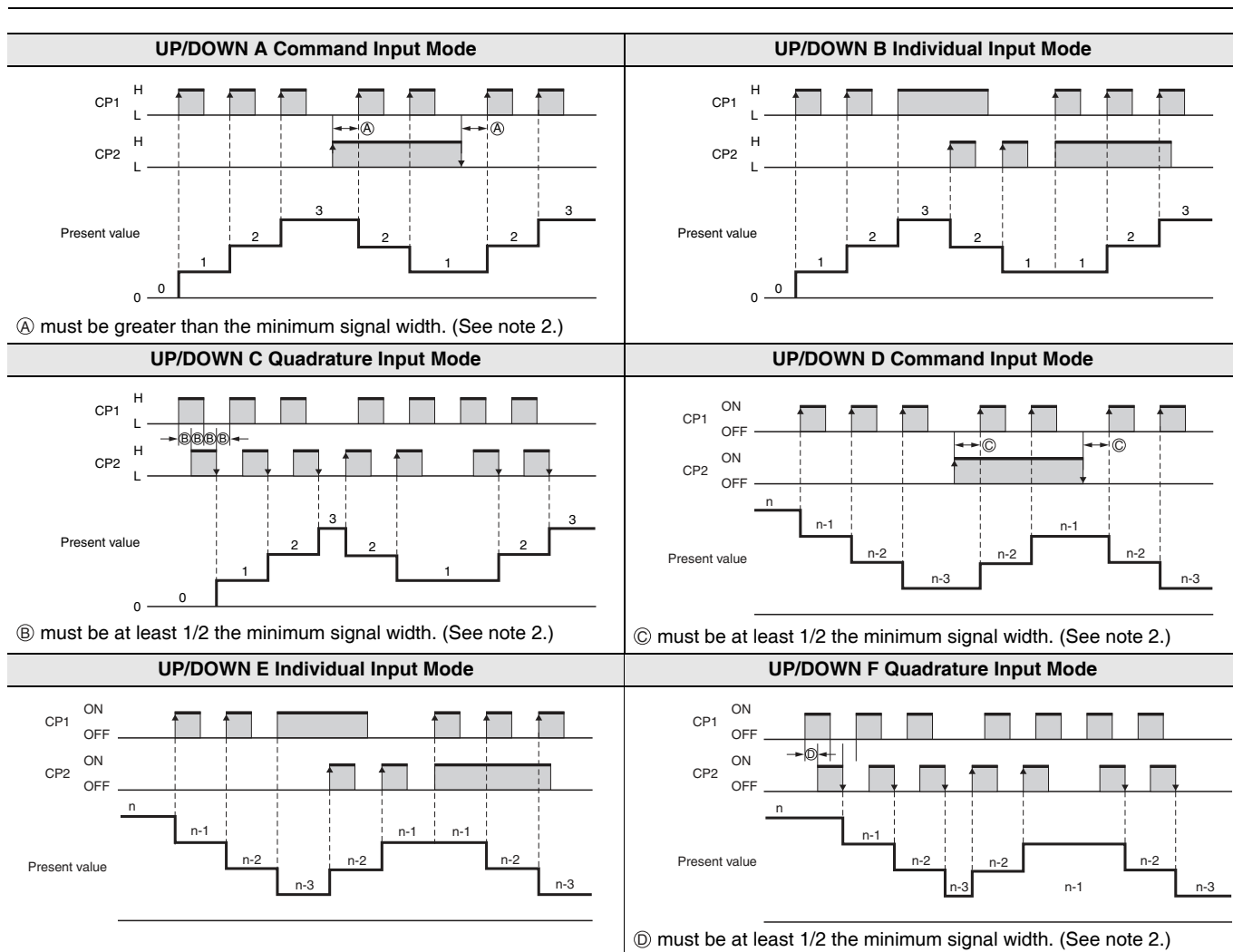

Note: 1. If the configuration selection is set to dual counter, CP1 and CP2 input will operate in the same way as the count input (CP1) of UP (increment) mode.

2. Ⓐ must be greater than the minimum signal width and Ⓑ must be at least 1/2 the minimum signal width. If they are less, a count error of ± 1 may occur.

3. Minimum signal width: 16.7 ms (when maximum counting speed = 30 Hz)
100 μ s (when maximum counting speed = 5 kHz)

4. The meaning of the H and L symbols in the tables is explained below.

Input method Symbol	No-voltage input (NPN input)	Voltage input (PNP input)
H	Short-circuit	4.5 to 30 VDC
L	Open	0 to 2 VDC

Input/Output Mode Settings

I/O Functions for Counter Operation

If a 1-stage model or 2-stage model is used as twin counter, the operation for output 2 will be performed. When using a 2-stage model as a 1-stage preset counter, total and preset counter, or dual counter, OUT1 and OUT2 turn ON and OFF simultaneously.

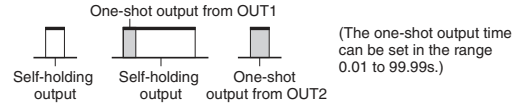

		Input mode		Operation after count completion	
		UP	DOWN		
Output mode setting	N			The outputs and present value display are held until reset/reset 1 is input.	
	F				The present value display continues to increase/decrease. The outputs are held until reset/reset 1 is input.

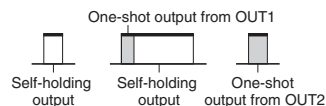

(The one-shot output time can be set in the range 0.01 to 99.99s.)

		Input mode		Operation after count completion
Output mode setting	C	UP	DOWN	<p>As soon as the count reaches SV, the present value display returns to the reset start status. The present value display does not show the present value upon count-up. The outputs repeat one-shot operation. OUT1 self-holding output turns OFF after the OUT2 one-shot output time. The OUT1 one-shot output time is independent of OUT2.</p>
		UP/DOWN A, B, C	UP/DOWN D, E, F	
		UP	DOWN	
		UP/DOWN A, B, C	UP/DOWN D, E, F	
	R	UP	DOWN	<p>The present value display returns to the reset start status after the one-shot output time. The outputs repeat one-shot operation. OUT1 self-holding output turns OFF after the OUT2 one-shot output time. The OUT1 one-shot output time is independent of OUT2.</p>
		UP/DOWN A, B, C	UP/DOWN D, E, F	
		UP	DOWN	
		UP/DOWN A, B, C	UP/DOWN D, E, F	

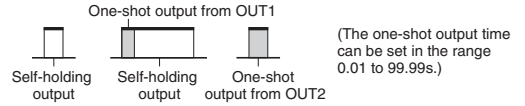

		Input mode		Operation after count completion
Output mode setting	K-1	UP	DOWN	The present value display continues to increase/decrease. OUT1 self-holding output turns OFF after the OUT2 one-shot output time. The OUT1 one-shot output time is independent of OUT2.
		UP/DOWN A, B, C	UP/DOWN D, E, F	
		UP	DOWN	
		UP/DOWN A, B, C	UP/DOWN D, E, F	
	P	UP	DOWN	The present value display does not change during the one-shot output time period, but the actual count returns to the reset start status. The output will return to one-shot mode. The outputs repeat one-shot operation. OUT1 self-holding output turns OFF after the OUT2 one-shot output time. The OUT1 one-shot output time is independent of OUT2.
		UP/DOWN A, B, C	UP/DOWN D, E, F	
		UP	DOWN	
		UP/DOWN A, B, C	UP/DOWN D, E, F	



		Input mode		Operation after count completion	
		UP	DOWN		
Output mode setting	Q			<p>The present value continues to increase/decrease for the one-shot output time, but returns to the reset start status after the one-shot output time has elapsed. The outputs repeat one-shot operation. OUT1 self-holding output turns OFF after the OUT2 one-shot output time. The OUT1 one-shot output time is independent of OUT2.</p>	
	A				<p>The present value display and OUT1 self-holding output is held until reset/reset 1 is input. OUT1 and OUT2 are independent.</p>

- Note:**
1. When the present value reaches 999999, it returns to 0.
 2. Counting cannot be performed during reset/reset 1 input.
 3. If reset/reset 1 is input while one-shot output is ON, one-shot output turns OFF.
 4. If there is power interruption while output is ON, output will turn ON again when the power supply has recovered, if memory backup is enabled.
For one-shot output, output will turn ON again for the duration of the output time setting once the power supply has recovered.
 5. Do not use the counter function in applications where the count may be completed (again) while one-shot output is ON.
 6. The setting range is 0 to 999999.

H7CC-A□ Counter

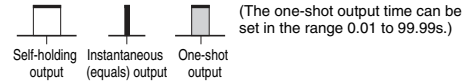

		Input mode UP/DOWN A, B, C	Operation after count completion
Output mode setting	K-2		The display continues to increase/decrease until the overflow or underflow value is reached. One-shot output only.
	D		The display continues to increase/decrease until the overflow or underflow value is reached. The outputs are ON while the count is equal.
	L		The display continues to increase/decrease until the overflow or underflow value is reached. OUT1 is held while the present value is less than or equal to set value 1. OUT2 is held while the present value is greater than or equal to set value 2.
	H		The display continues to increase/decrease until the overflow or underflow value is reached. OUT1 is held while the present value is greater than or equal to set value 1. OUT2 is held while the present value is greater than or equal to set value 2. * H mode is available only when using a model as a 2-stage counter.

- Note:**
- Counting cannot be performed during reset/reset 1 input.
 - If reset/reset 1 is input while one-shot output is ON, one-shot output turns OFF.
 - If there is power interruption while output is ON, output will turn ON again when the power supply has recovered, if memory backup is enabled.
For one-shot output, output will turn ON again for the duration of the output time setting once the power supply has recovered.
 - Do not use the counter function in applications where the count may be completed (again) while one-shot output is ON.
 - The set value is from -99999 to 999999.

Total and Preset Counter Operation

The H7CC has a total counter, separate from the 1-stage preset counter, for counting the total accumulated value.

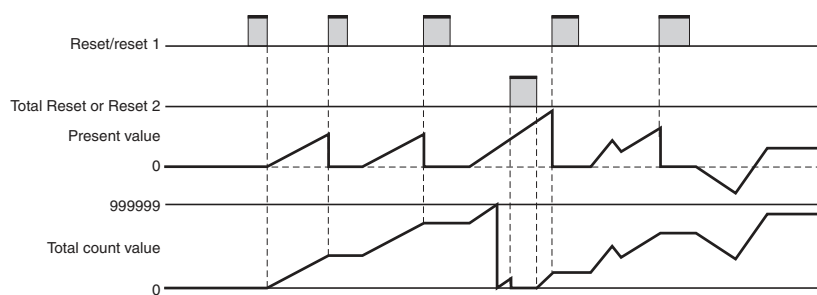

- The total counter continues to count the total accumulated value when the present value is reset using reset/reset 1 input (reset operation).
- The total count value is reset when the total reset/reset 2 input is turned ON. If reset operation is performed while the total count value is displayed, the total count value is reset. The present value is also reset at this time.
- The counting range of the total counter is -99,999 to 999,999. The total count value returns to 0 when it reaches 999,999.

Batch Counter Operation

The H7CC has a batch counter, separate from the 1-stage preset counter, for counting the number of times the count has been completed.

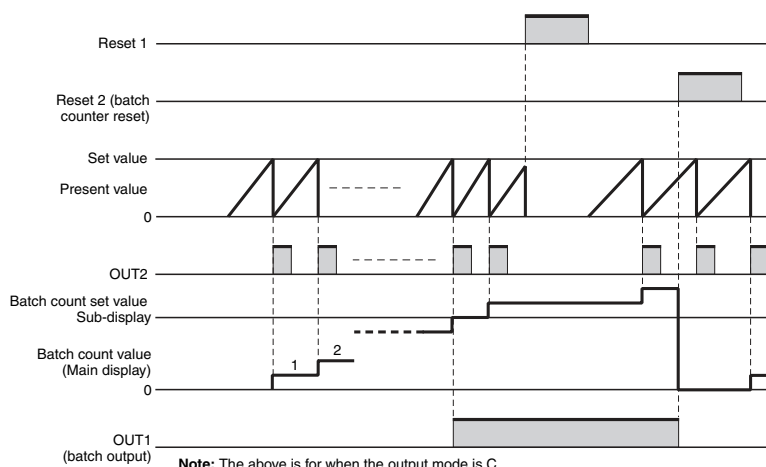

- The batch counter continues after count completion.
- Batch output is held until batch counter reset is input.
- When the batch counter reset input is turned ON, the batch count value is reset, and batch output turns OFF.
- If reset operation is performed while the batch count value is displayed, the batch count value is reset and batch output turns OFF. The present value is also reset at this time.
- The count value can be incremented and decremented. The batch count is only incremented.
- The maximum counting speed for batch counter operation is 5 kHz. The batch counter counts the number of times the count reaches the set value.

- Note:**
1. The batch count value is held at 0 during batch counter reset input.
 2. If the batch count set value is 0, batch count will be performed but there will be no batch output.
 3. The batch count value returns to 0 when it reaches 999,999.
 4. Once batch output has been turned ON, it will return to the ON after power interruptions, if memory backup is enabled.
 5. If the batch count set value is changed from a value that is greater than the batch count value to one that is less, batch output will turn ON.
 6. After batch output turns ON, the ON state will be held even if the batch count set value is changed to a value greater than the batch count value.

Dual Counter Operation

Using the dual counter allows the count from 2 inputs to be added or subtracted and the result displayed. It is possible to specify a set value for which output turns ON when the set value matches the added or subtracted result.

(1) Dual Count Calculating Mode = ADD
Dual count value = CP1 PV + CP2 PV

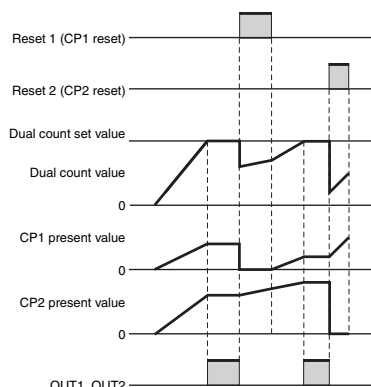

Note: The above is for when the output mode is N.

(2) Dual Count Calculating Mode = SUB
Dual count value = CP1 PV - CP2 PV

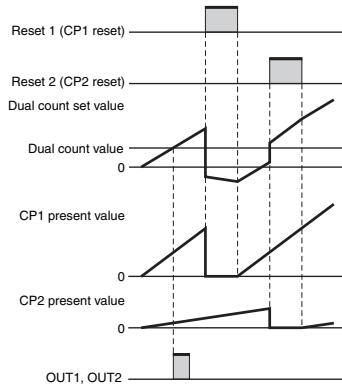

Note: The above is for when the output mode is K-2. SUB mode can be used only when K-2, D, L, or H is selected as the output mode with 6-digit models.

- The operation after count completion for the dual counter value is determined by the output mode.
- The CP1 present value is reset when reset 1 input is turned ON. The CP2 present value is reset when reset 2 input is turned ON.
- If reset operation is performed while the dual count value, CP1 present value, or CP2 present value is displayed, all of the present values are reset and outputs turn OFF. At this time, counting is not possible for CP1 or CP2 inputs.

- Note:**
1. Counting is not possible for CP1 during reset 1 input. CP2 will not be affected. The dual count value will be calculated based on a CP1 present value of 0.
 2. Counting is not possible for CP2 during reset 2 input. CP1 will not be affected. The dual count value will be calculated based on a CP2 present value of 0.
 3. The counting range for the dual count value is -99,999 to 999,999. The counting ranges for the CP1 present value and CP2 present value are 0 to 999,999. If a present value exceeds 999,999, FFFFFFFF will be displayed to indicate an overflow, and all counting will stop.

H7CC-A□ Counter

Twin Counter Operation

Two independent counters are built in.

	Counter 1	Counter 2
Counter input	CP1	CP2
Reset input	Reset 1	Reset 2
Present value display and setting	<div style="display: flex; justify-content: space-around; align-items: center;"> <div style="text-align: center;"> <p>Counter 1 display</p> <p>Counter 1 present value</p> <p>Counter 1 set value</p> </div> <div style="text-align: center;"> <p>Counter 2 display</p> <p>Counter 2 present value</p> <p>Counter 2 set value</p> </div> </div> <p style="text-align: center;">← UP1+UP3 or DW1+DW3 →</p>	
Reset operation	Only counters appearing on the display will be reset.	

- Note:**
1. Only 2-stage models
 2. Increment mode only for counters 1 and 2.
 3. The settings for prescaling and the decimal point are used by both counter 1 and 2.

Reset Function List

I/O Functions for Counter Operation

Function	1-stage/2-stage preset counter	Total and preset counter		Batch counter		Dual counter		Twin counter	
		Present value/ set value	Total count value	Present value/ set value	Batch count value/ batch count set value	Dual count value/dual count set value	CP1 present value/ CP2 present value	Present value 1/ Set value 1	Present value 2/ Set value 2
Screen displayed in run mode	Present value/ set value (1, 2)	Present value/ set value	Total count value	Present value/ set value	Batch count value/ batch count set value	Dual count value/dual count set value	CP1 present value/ CP2 present value	Present value 1/ Set value 1	Present value 2/ Set value 2
Reset/reset 1	Present value and output reset.	Present value and output reset.		Present value and output reset.		Only the CP1 present value is reset.		Only the CP1 present value is reset.	
Total reset or reset 2	No effect	Only the total count value is reset.		Batch count value and batch output reset.		Only the CP2 present value is reset.		Only the CP2 present value is reset.	
Reset operation	Present value and output reset.	Present value and output reset.	Present value, total count value, and output reset.	Present value and output reset.	Present value, batch count value, output and batch output reset.	CP1 present value, CP2 present value, dual count value, and output reset.		CP1 present value reset	CP2 present value reset

- The following table shows the delay from when the present value passes the set value until the output is produced.

Actual measurements in N and K-2 modes (Reference values)

Control output type	Max. counting speed	Output delay time
Contact output	30 Hz	16.4 to 18.2 ms
	5 kHz	3.9 to 5.4 ms
Transistor output	30 Hz	11.2 to 14.2 ms
	5 kHz	0.09 to 0.1 ms

Note: The above times may vary slightly depending on the mode or operating conditions.

Setting Procedure Guide Tachometer Operation

Step1 The H7CC-AW□/AU□ is a Counter that contains more than one functional counter. At the time of delivery *, the H7CC is set to the 1-stage preset counter configuration or 2-stage preset counter configuration. Enter configuration selection mode using the following chart and set the tachometer mode.

* Table Default Modes and Selectable Functions

Model	Default mode	Selectable mode
H7CC-AW	2-stage preset counter	Any mode
H7CC-AU	1-stage preset counter	Any mode

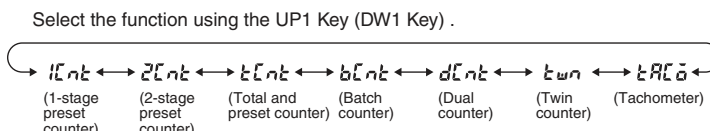
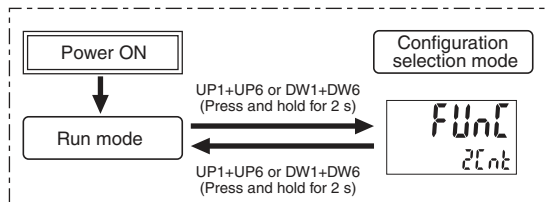

Step2 Parameters are set with the operation keys on the front panel.

Change to Function Setting Mode.

For details on operations and display in run mode, refer to page 37.

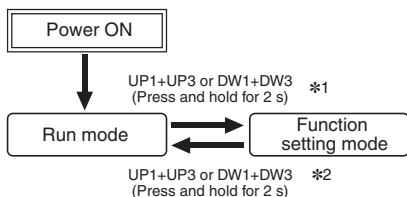

- *1 If the mode is switched to the function setting mode during operation, operation will continue.
- *2 Changes made to settings in function setting mode are enabled for the first time when the mode is changed to run mode. Also, when settings are changed, the counter is reset (present value initialized and output turned OFF) on returning to run mode.

The characters displayed in reverse video are the default settings. In the function setting mode, the status indicator of the keys that can be set lights up. (Example) In the case of the prescale value (PSCL) A value from 0.001 to 99.999 can be set, and therefore, the status indicator of the UP1 Key to UP5 Key (DW1 Key to DW5 Key) lights up.

* Use UP1+UP3 to move up and DW1+DW3 to move down

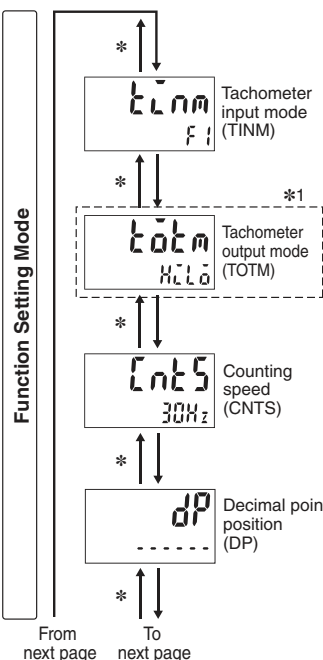
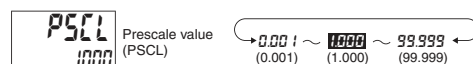

• Set the tachometer input mode using the UP1 Key (DW1 Key).

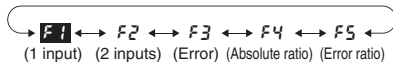

*1 Set tachometer output modes 1 and 2 using the UP1 Key (DW1 Key). **Note:** Displayed only when the tachometer input mode is F2 (2 inputs).

• Set the tachometer output mode using the UP1 Key (DW1 Key).

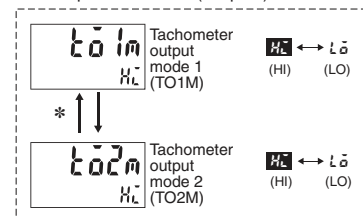
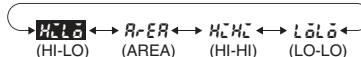

Note: The indicator display is disabled during the upper or lower limit setting.

• Set the counting speed using the UP1 Key (DW1 Key).

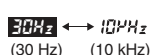

Note: Even if 10 kHz is selected when the tachometer input mode is F2 to F5, the counting speed will be 5 kHz.

• Set the decimal point position using the UP1 Key (DW1 Key).

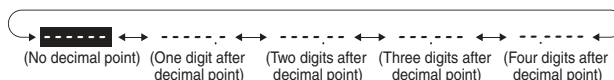

Note: "--.----" will be displayed when pulse width measurement is set or when the display unit is set to seconds.

Function Setting Mode

To previous page From previous page

* Use UP1+UP3 to move up and DW1+DW3 to move down

<div style="border: 1px solid black; padding: 5px; margin-bottom: 5px;"> PSCL 1000 </div>	<p>Prescale value (PSCL)</p>	<ul style="list-style-type: none"> Set each digit using the individual UP1 to UP5 Keys (DW1 to DW5 Keys). <p style="text-align: center;"> \rightarrow 0.001 ~ 99.999 \leftarrow (0.001) (1.000) (99.999) </p>
<div style="border: 1px solid black; padding: 5px; margin-bottom: 5px;"> AVGT SMP </div>	<p>Averaging method (AVGT)</p>	<ul style="list-style-type: none"> Set the averaging method using the UP1 Key (DW1 Key). <p style="text-align: center;"> \leftarrow SMP \leftrightarrow MV \leftarrow (Simple averaging) (Moving average) </p>
<div style="border: 1px solid black; padding: 5px; margin-bottom: 5px;"> AVGN OFF </div>	<p>Average processing (AVGN)</p>	<ul style="list-style-type: none"> Set the number of averaging times using the UP1 Key (DW1 Key). <p style="text-align: center;"> \leftarrow OFF \leftrightarrow 2 \leftrightarrow 4 \leftrightarrow 8 \leftrightarrow 16 \leftarrow (No average processing) (Average of 2 measurements) (Average of 4 measurements) (Average of 8 measurements) (Average of 16 measurements) </p>
<div style="border: 1px solid black; padding: 5px; margin-bottom: 5px;"> AUTO0 999.9 </div>	<p>Auto-zero time (AUTO0)</p>	<ul style="list-style-type: none"> Set each digit using the individual UP1 to UP4 Keys (DW1 to DW4 Keys). <p style="text-align: center;"> \rightarrow 0.1 ~ 999.9 \leftarrow (0.1 s) (999.9 s) </p>
<div style="border: 1px solid black; padding: 5px; margin-bottom: 5px;"> STMR 00 </div>	<p>Startup time (STMR)</p>	<ul style="list-style-type: none"> Set each digit using the individual UP1 to UP3 Keys (DW1 to DW3 Keys). <p style="text-align: center;"> \rightarrow 0.0 ~ 99.9 \leftarrow (0.0 s) (99.9 s) </p>
<div style="border: 1px solid black; padding: 5px; margin-bottom: 5px;"> IMOD nPN </div>	<p>NPN/PNP input mode (IMOD)</p>	<ul style="list-style-type: none"> Set the NPN/PNP input mode using the UP1 Key (DW1 Key). <p style="text-align: center;"> \leftarrow nPN \leftrightarrow pPN \leftarrow (NPN input) (PNP input) </p>
<div style="border: 1px solid black; padding: 5px; margin-bottom: 5px;"> DHLD OFF </div>	<p>Peak/bottom hold enabled (DHLD)</p>	<ul style="list-style-type: none"> Enable or disable the peak/bottom hold using the UP1 Key (DW1 Key). <p style="text-align: center;"> \leftarrow OFF \leftrightarrow ON \leftarrow (Disabled) (Enabled) </p>
<div style="border: 1px solid black; padding: 5px; margin-bottom: 5px;"> HYS 0 </div>	<p>Output hysteresis (HYS)</p>	<ul style="list-style-type: none"> Set the output hysteresis using the UP1 to UP5 Keys (DW1 to DW5 Keys). <p style="text-align: center;"> \rightarrow 0 ~ 99999 \leftarrow (0) (99999) </p> <p>Note: The position of the decimal point for the value after prescaling will be set according to the decimal point position setting.</p>
<div style="border: 1px solid black; padding: 5px; margin-bottom: 5px;"> OFFD 000 </div>	<p>Output OFF delay (OFFD)</p>	<ul style="list-style-type: none"> Set each digit using the individual UP1 to UP4 Keys (DW1 to DW4 Keys). <p style="text-align: center;"> \rightarrow 0.00 ~ 19.99 \leftarrow (0.00 s) (19.99 s) </p>
<div style="border: 1px solid black; padding: 5px; margin-bottom: 5px;"> SL-H 9999999 </div>	<p>Set value upper limit (SL-H)</p>	<ul style="list-style-type: none"> Set each digit using the individual UP1 to UP6 Keys (DW1 to DW6 Keys). <p style="text-align: center;"> \rightarrow 1 ~ 9999999 \leftarrow (1) (9999999) </p> <p>Note: The position of the decimal point for the value after prescaling will be set according to the decimal point position setting.</p>
<div style="border: 1px solid black; padding: 5px; margin-bottom: 5px;"> OTST OFF </div>	<p>Output allocation (OTST)</p>	<ul style="list-style-type: none"> Set the output allocation using the UP1 Key (DW1 Key). <p style="text-align: center;"> \leftarrow OFF \leftrightarrow ON \leftarrow (OFF) (ON) </p> <p>Note: OFF: Output 1 (OUT1) = 12, 13 Output 2 (OUT2) = 3, 4, 5/ ON: Output 1 (OUT1) = 3, 4, 5 Output 2 (OUT2) = 12, 13 (The numbers are the terminals numbers.)</p>
<div style="border: 1px solid black; padding: 5px; margin-bottom: 5px;"> KYPT KP-1 </div>	<p>Key protect level (KYPT)</p>	<ul style="list-style-type: none"> Set the key protect level using the UP1 Key (DW1 Key). <p style="text-align: center;"> \leftarrow KP-1 \leftrightarrow KP-2 \leftrightarrow KP-3 \leftrightarrow KP-4 \leftrightarrow KP-5 \leftrightarrow KP-6 \leftrightarrow KP-7 \leftarrow (KP-1) (KP-2) (KP-3) (KP-4) (KP-5) (KP-6) (KP-7) </p>

From next page

To next page

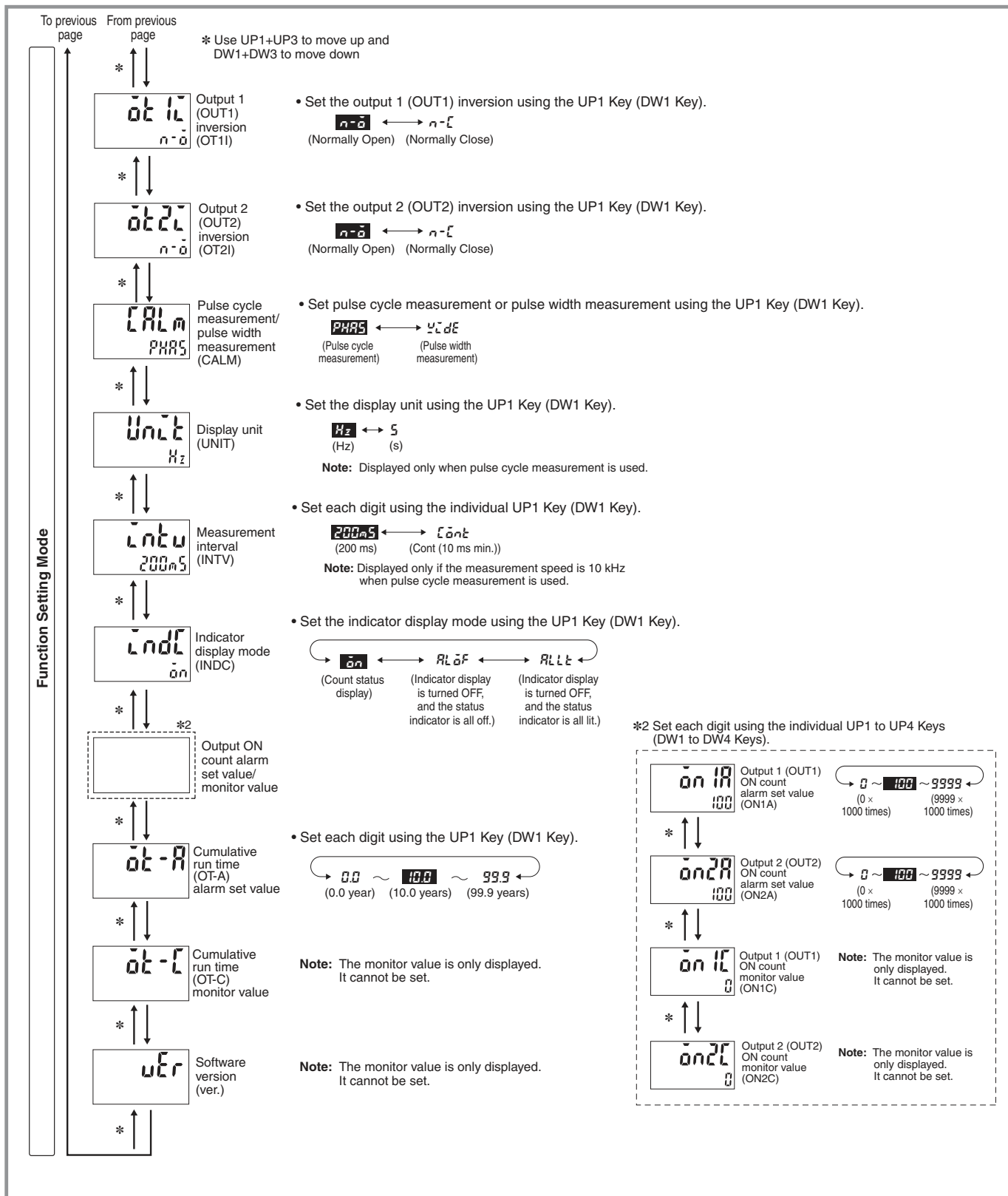

Explanation of Functions

Tachometer Operation

Tachometer Input Mode (㉔㉓㉒㉑)

Set the count input mode to one of the following: 1 input (㉔㉓), 2 inputs (㉔㉒), error (㉔㉑), absolute ratio (㉔㉐), or error ratio (㉔㉏).

Input mode	Input	Internal processing	Application
1 input	Count 1	None	Operation with only one input.
2 inputs	Counts 1 and 2	None	Operation with two independent inputs.
Error	Counts 1 and 2	Count 1 input – Count 2 input	Measuring the difference between two inputs (error in number of revolutions).
Absolute ratio	Counts 1 and 2	Count 1 input + Count 2 input	Measuring the ratio of two inputs (ratio of number of revolutions).
Error ratio	Counts 1 and 2	(Count 1 input – Count 2 input) + Count 2 input	Measuring the ratio of error for two inputs (measuring the error ratio of number of revolutions).

Tachometer Output Mode (㉔㉏㉓㉒)

Set the output method for control output based on the comparison value. Upper and lower limit (HI-LO), area (AREA), upper limit (HI-HI), and lower limit (LO-LO) can be set. (For details on the output modes, refer to *Output Mode Settings and Operation* on page 38.)

Counting Speed (㉔㉓㉒)

Set the maximum counting speed (30 Hz/10 kHz) for CP1 input. If contacts are used for input signals, set the counting speed to 30 Hz. Processing to eliminate chattering is performed for this setting.

Decimal Point Position (㉔㉓)

Decide the decimal point position for the measurement value, OUT1 set value, and OUT2 set value.

Prescale Value (㉔㉓㉒)

It is possible to display the rate of rotation or the speed of a device or machine to which the H7CC is mounted by converting input pulses to a desired unit.

If this prescaling function is not used, the input frequency (Hz) will be displayed.

It is also possible to specify time (seconds) as the display value. Refer to *Display Unit* on page 35 for details.

The relationship between display and input is determined by the following equation. Set the prescale value according to the unit to be displayed.

$$\text{Displayed value} = f \times \alpha$$

f: Input pulse frequency (number of pulses in 1 second)

α: Prescale value

(1) Displaying Rotation Rate

Display unit	Prescale value (α)
rpm	$1/N \times 60$
rps	$1/N$

N: Number of pulses per revolution

Example: To display the rate of rotation for a machine that outputs 5 pulses per revolution in the form □□.□ rpm:

- Set the decimal point position to 1 decimal places.
- Using the formula, set the prescale value (α) to $1/N \times 60 = 60/5 = 12$.

(2) Displaying Speed

Display unit	Prescale value (α)
m/min	$\pi d \times 1/N \times 60$
m/s	$\pi d \times 1/N$

N: Number of pulses per revolution

d: Diameter of rotating body (m)

πd: Circumference (m)

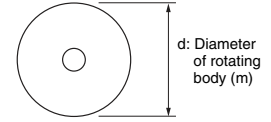

- Observe the following points when setting a prescale value. Set the set value to a value less than {Maximum countable value – Prescale value}. Example: If the prescale value is 1.25 and the counting range is 0.000 to 999.999, set the set value to a value less than 998.749 (= 999.999 – 1.25). If the set value is set to a value greater than this, output will not turn ON.
- Output will turn ON, however, if a present value overflow occurs (FFFFFF).

Note: If the prescale value setting is incorrect, a counting error will occur. Check that the settings are correct before using this function.

Averaging Method (㉔㉓㉒)

A simple average or moving average can be selected for the averaging. With the moving average method, the average of the measurement values is displayed each sampling cycle, in contrast to a simple average, with which the the average of the set number of samples is displayed.

Number of Averaging Times (㉔㉓㉒)

Flickering display and output chattering can be prevented using average processing. Average processing can be set to one of four levels: no average processing, 2 times (i.e., the average of 2 measurement values), 4 times, 8 times, or 16 times. The measurement cycle will be equal to the sampling cycle multiplied by the average processing setting (i.e., the number of times). Average processing enables stable displays even for fluctuating input signals. Set the optimum number of times for the application.

Auto-zero Time (㉔㉓㉒)

The display can be force-set to 0 if there is no pulse for a certain period of time. This time is called the auto-zero time. Set the auto-zero time to a time slightly longer than the estimated interval between input pulses. Accurate measurement is not possible if the auto-zero time is set to a time shorter than the input pulse cycle. Setting a time that is too long may also result in problems, such as a time-lag between rotation stopping and the alarm turning ON. The auto-zero time is not applied to pulse width measurements.

Startup Time (5t nr)

To prevent undesired outputs resulting from unstable inputs immediately after the power supply is turned ON, it is possible to prohibit measurement for a set period of time, the startup time. It can also be used to stop measurements and disable outputs until the rotating body reaches the normal rate of rotation, after the power supply to the H7CC and rotating body are turned ON at the same time.

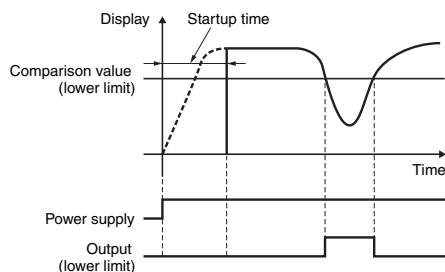

NPN/PNP Input Mode (n̄ nōd)

Select either NPN input (no-voltage input) or PNP input (voltage input) as the input format. When using a two-wire sensor, select NPN input. The same setting is used for all external inputs. For details on input connections, refer to *Input Connections* on page 9.

Peak/bottom Hold Enabled (dHl d)

This function records the peak and bottom (i.e., minimum) after counting starts (after turning ON the power supply or changing the configuration selection mode or function setting). The peak value is also held when the power supply is interrupted.

Output Hysteresis (HYS)

This setting can be used to prevent output chattering if the measurement value fluctuates slightly near the set value. The measurement value after prescaling is set.

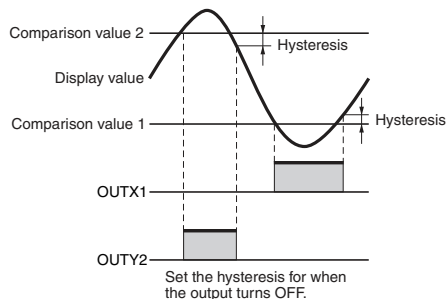

Output OFF Delay (ōFFd)

This function delays the timing for turning OFF comparative output by a certain time. The ON time can be held for the set time if the comparative result changes in a short time. Operation will continue and outputs will not change when holding the value.

Set Value Upper Limit (5L -H)

Set the upper limit for the set value when it is set in run mode. The limit can be set to between 1 and 999999.

Key Protect Level (k̄ 3Pē)

Set the key protect level. Refer to *Key Protect Level* on page 40.

Pulse Cycle Measurement/Pulse Width Measurement (ē Pē n)

Set the measurement mode to pulse cycle measurement or pulse width measurement. With pulse cycle measurement, the number of pulse cycles that occur in 1 s is measured. With pulse width measurement, the ON time for one pulse is measured. An input OFF period of at least 20 ms is required for pulse width measurement. If there is no input pulse during pulse width measurement, the previously measured value will be held.

Display Unit (ū nēē)

When pulse cycle measurement is used, set the display unit to Hz (hertz) or s (seconds).

Counting Interval (ē nēē)

If the measurement speed is 10 kHz when pulse cycle measurement is used, set the measurement interval to 200 ms or Cont (10 ms min.).

ON Count Alarm Set Values for Outputs 1 and 2 (OUT1 and OUT2) (ōn iR and ōnēR)

The output ON count for notifying the replacement time can be set. For details, refer to page 41.

ON Count Monitor Values for Outputs 1 and 2 (OUT1 and OUT2) (ōn iē and ōnēē)

The monitor value for output 1 and 2 (OUT1 and OUT2) is only displayed. It cannot be set. The output ON count will be 1,000 times the displayed value.

Output Allocation (Settings applicable to only H7CC-□W(U)□) (ōē 5ēē)

Set the allocation of outputs 1 and 2 (OUT1 and OUT2). If output allocation is OFF, output 1 (OUT1) is allocated to terminals (12) and (13), and output 2 (OUT2) is allocated to terminals (3), (4), and (5). If output allocation is ON, output 1 (OUT1) is allocated to terminals (3), (4), and (5), and output 2 (OUT2) is allocated to terminals (12) and (13).

Output inversion (ōē iē, ōēēē)

Set logical inversion of output ON/OFF. In the case of two outputs, it is possible to individually set output inversion for each of output 1 and output 2 (OUT1 and OUT2). If output inversion is n̄ō (Normally Open), the output turns ON when the set value is reached. If output inversion is n̄ē (Normally close), the output turns OFF when the set value is reached.

H7CC-A□ tachometer

Indicator Display Mode (인디케이터 표시 모드)

Settings can be made to display the measurement value in status indicator. When this mode is ON, and "Upper and lower limit" or "Area" has been selected in the tachometer output mode, the status indicator changes in accordance with the ratio of the measurement value to the comparison value. In the case of ALOF, the indicator display is turned OFF, and the status indicator is all off. In the case of ALLT, the indicator display is turned OFF, and the status indicator is all lit.

(Example 1) When the upper and lower limits have been selected
The status indicator lights up when the status reaches 1/6, 2/6, 3/6 (50%), 4/6, 5/6, 6/6 (100%) in accordance with the ratio of the measurement value to the comparison value. If comparison value 1 = 2000 and comparison value 2 = 2300 have been set, all status indicators are off when the measurement value is below 2050, the three status indicators on the left light up when the measurement value reaches 2150, and all status indicators light up when the measurement value becomes 2300 or more.

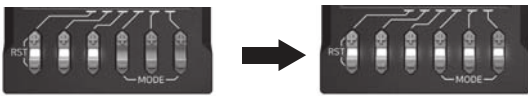

Three indicators light up when the status reaches 50%

All indicators light up when the status reaches 100%

Cumulative Run Time Alarm Set Value (누적 운전 시간 경고 설정 값)

The cumulative run time for notifying the replacement time can be set. For details, refer to page 41.

Cumulative Run Time Monitor (누적 운전 시간 모니터)

The cumulative run time is displayed. It is not a setting item. The numerical values are displayed in increments of 0.1 years.

Operation in Run Mode

Tachometer Operation

- Set each digit using the individual UP1 to UP6 Keys (DW1 to DW6 Keys).

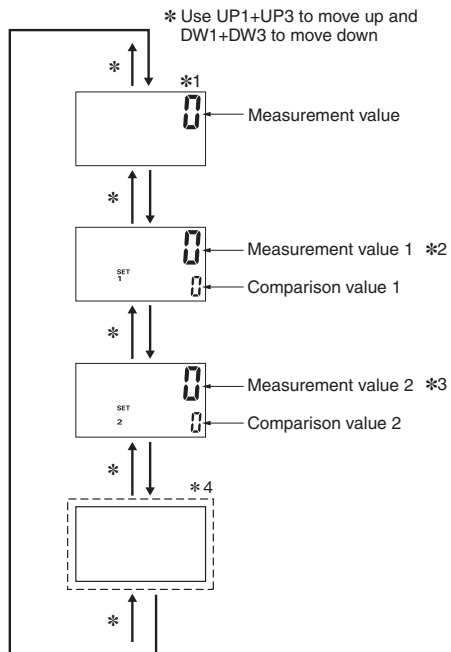
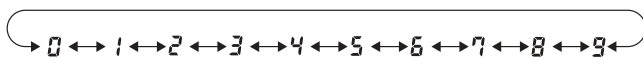

- **Measurement value**
Displays the currently measured value.
- **Comparison value 1/Comparison value 2**
Set comparison value 1 and comparison value 2. The measurement value is compared to comparison value 1 and comparison value 2 and output is made according to the selected output mode.

- *1. Not displayed for the 2-input mode.
- *2. Measurement value 1 for the 2-input input mode.
- *3. Measurement value 2 for the 2-input input mode.

*4. Peak/bottom hold enabled

Displayed when the input mode is not 2 inputs.

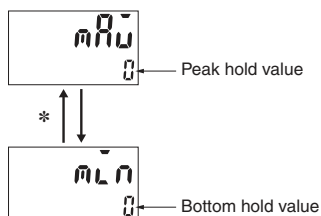

* Use UP1+UP3 to move up and DW1+DW3 to move down

Displayed for the 2-input input mode.

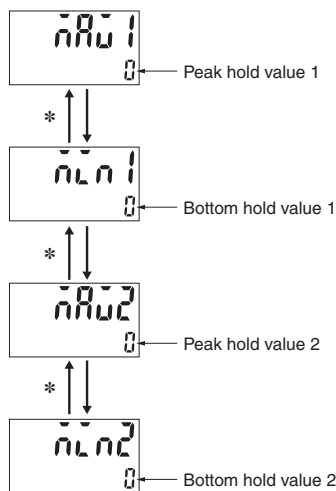

* Use UP1+UP3 to move up and DW1+DW3 to move down

- **Peak/bottom hold value**
The peak (maximum) and bottom (minimum) values are displayed after counting starts.
 - **Peak/bottom hold value 1 and 2**
Peaks (maximums) 1 and 2 and bottoms (minimums) 1 and 2 are displayed after counting starts.
- Note:** The hold values will be initialized when reset operation is performed or reset 1 input is turned OFF while peak/bottom hold values 1 and 2 are being displayed. (The reset 2 input operates in the same way if the input mode is set to 2-input mode.)

Output Mode Setting and Operation

Tachometer Operation

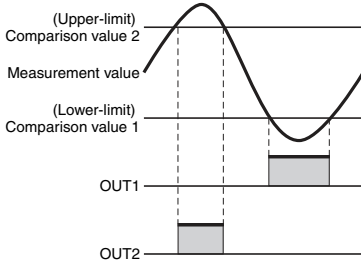
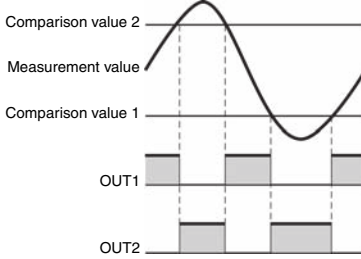
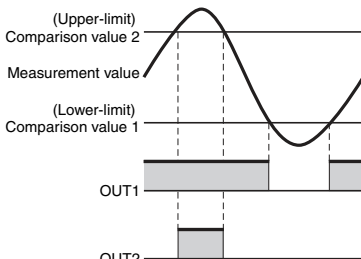
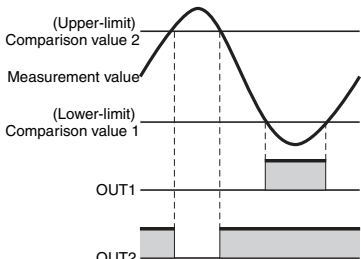
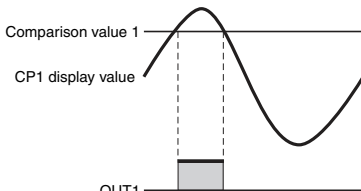
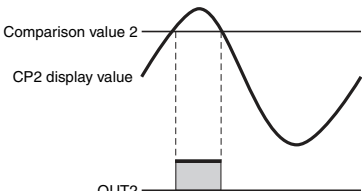
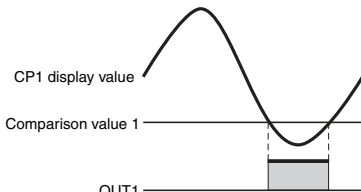
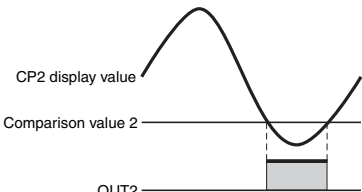
Input mode setting	Output mode setting	Operation									
1 input Error Absolute ratio Error ratio	Upper and lower limit (HI-LO)	 <p>ON condition for OUT1: Measurement value \leq Comparison value 1 ON condition for OUT2: Measurement value \geq Comparison value 2</p>									
	Area (AREA)	 <table border="1" data-bbox="821 627 1436 884"> <thead> <tr> <th>Condition</th> <th>Comparison value 1 \leq Comparison value 2</th> <th>Measurement value 1 > Comparison value 2</th> </tr> </thead> <tbody> <tr> <td>ON condition for OUT1</td> <td>Comparison value 1 \leq Measurement value \leq Comparison value 2</td> <td>Comparison value 2 \leq Measurement value \leq Comparison value 1</td> </tr> <tr> <td>ON condition for OUT2</td> <td>Measurement value < Comparison value 1 or Measurement value > Comparison value 2</td> <td>Measurement value < Comparison value 2 or Measurement value > Comparison value 1</td> </tr> </tbody> </table>	Condition	Comparison value 1 \leq Comparison value 2	Measurement value 1 > Comparison value 2	ON condition for OUT1	Comparison value 1 \leq Measurement value \leq Comparison value 2	Comparison value 2 \leq Measurement value \leq Comparison value 1	ON condition for OUT2	Measurement value < Comparison value 1 or Measurement value > Comparison value 2	Measurement value < Comparison value 2 or Measurement value > Comparison value 1
	Condition	Comparison value 1 \leq Comparison value 2	Measurement value 1 > Comparison value 2								
	ON condition for OUT1	Comparison value 1 \leq Measurement value \leq Comparison value 2	Comparison value 2 \leq Measurement value \leq Comparison value 1								
ON condition for OUT2	Measurement value < Comparison value 1 or Measurement value > Comparison value 2	Measurement value < Comparison value 2 or Measurement value > Comparison value 1									
Upper limit (HI-HI)	 <p>ON condition for OUT1: Measurement value \geq Comparison value 1 ON condition for OUT2: Measurement value \geq Comparison value 2</p>										
Lower limit (LO-LO)	 <p>ON condition for OUT1: Measurement value \leq Comparison value 1 ON condition for OUT2: Measurement value \leq Comparison value 2</p>										
2 inputs	Upper limit (HI)	<div style="display: flex; justify-content: space-around;"> <div data-bbox="443 1489 805 1724"> <p>Output 1</p>  <p>ON condition for output 1: CP1 present value (display value) \geq Comparison value 1</p> </div> <div data-bbox="901 1489 1264 1724"> <p>Output 2</p>  <p>ON condition for output 2: CP2 present value (display value) \geq Comparison value 2</p> </div> </div>									
	Lower limit (LO)	<div style="display: flex; justify-content: space-around;"> <div data-bbox="443 1803 805 2038"> <p>Output 1</p>  <p>ON condition for output 1: CP1 present value (display value) \leq Comparison value 1</p> </div> <div data-bbox="901 1803 1264 2038"> <p>Output 2</p>  <p>ON condition for output 2: CP2 present value (display value) \leq Comparison value 2</p> </div> </div>									

Switching between Preset Counter, Total and Preset Counter, Batch Counter, Dual Counter, Twin Counter, and Tachometer Operation

Select which H7CC configuration is used (i.e., preset counter, total and preset counter, batch counter, dual counter, twin counter, or tachometer) in configuration selection mode.

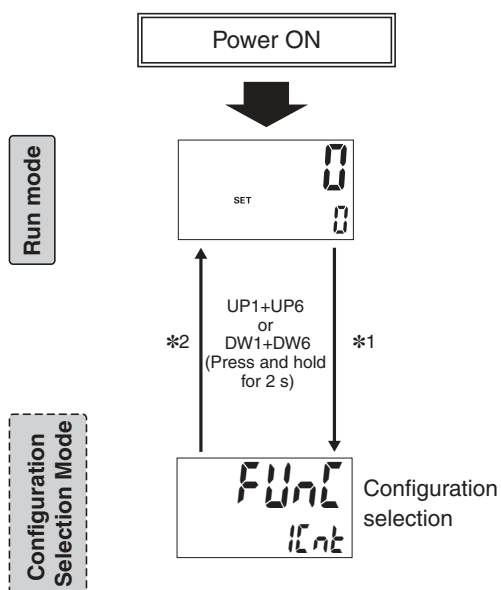

Note

To shift to the configuration selection mode, press UP1+UP6 or DW1+DW6 for 2 seconds or longer.

Select the function using the UP1 Key (DW1 Key) .

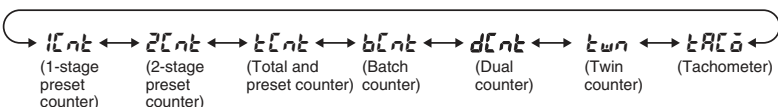

Note: The modes that can be selected depend on the model. (Refer to the Table.)

Note: At the time of delivery *, the H7CC is set to the 1-stage preset counter configuration or 2-stage preset counter configuration.

* Table Default Modes and Selectable Functions

Model	Default mode	Selectable mode
H7CC-AW	2-stage preset counter	Any mode
H7CC-AU	1-stage preset counter	Any mode
Other models	1-stage preset counter	1-stage preset or total preset counter only

*1 When the mode is changed to configuration selection mode, the present value is reset, outputs turn OFF, and counting (measuring) stops.

*2 Setting changes made in configuration selection mode are enabled when the mode is changed to run mode. If the configuration is changed, the set value (or set value 1 and set value 2), comparison value 1 and comparison value 2 are initialized.

Hold Function

The measurement value (display value) and output are sustained while the hold input is ON.

Note: The output will maintain the current status when hold operation is performed.

Example:

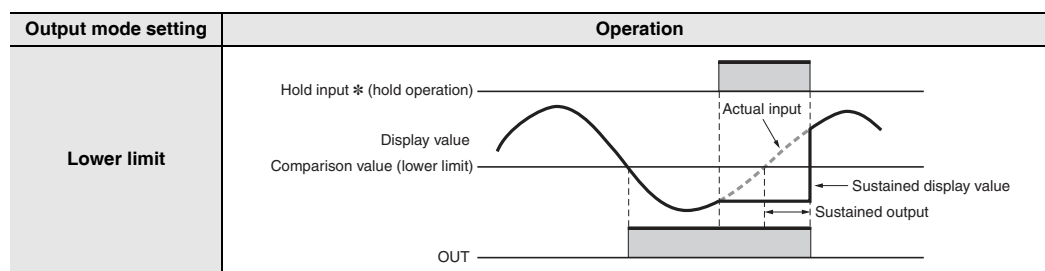

Key Protect Level

It is possible to prevent setting errors by prohibiting the use of certain operation keys by specifying the key protect level (KP-1 to KP-7) when the key-protect switch is set to ON. The key protect level is set in the function setting mode. The key protect indicator is lit when the key-protect switch is ON.

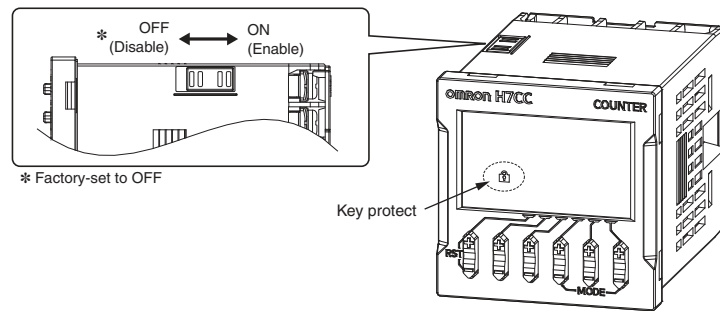

Level	Description	Details			
		Changing modes*	Switching display during operation	Reset operation	Up/Down Keys
KP-1 (default setting)		Invalid	Valid	Valid	Valid
KP-2		Invalid	Valid	Invalid	Valid
KP-3		Invalid	Valid	Valid	Invalid
KP-4		Invalid	Valid	Invalid	Invalid
KP-5		Invalid	Invalid	Invalid	Invalid
KP-6		Invalid	Invalid	Valid	Valid
KP-7		Invalid	Invalid	Invalid	Valid

* Changing mode to configuration selection mode or function setting mode.

Replacement Time Notification Function

The counter includes parts such as electrolytic capacitors and relays that deteriorate with time or with repeated operations.

The H7CC is equipped with a function for notifying the replacement time by the cumulative run time and ON count of the relay contact.

When either one of the deterioration of the electrolytic capacitors due to the cumulative run time or the deterioration of the relay contact due to the output ON count reaches the replacement time, **RPLC** (REPLACE) can be displayed on the Timer. For details on RPLC display, refer to *Self-diagnosis Function* on this page.

Cumulative Run Time Alarm Set Value ($\bar{\alpha}t - R$)

The cumulative run time can be set in a range from 0.0 to 99.9 years. The replacement time notification function is disabled if 0 is set. 10 years is set in the default settings.

If the cumulative run time reaches the alarm set value or above, an RPLC (replacement time) error can be displayed on the Timer.

The extent of deterioration of electrolytic capacitors varies depending on the capacitor temperature and usage period. According to the default settings, the ambient temperature is 35°C, the output load is 50%, and the utilization rate is 100%. If you are changing the actual usage conditions, enter the ambient temperature, output load, and utilization rate in the H7CC replacement time calculation tool available on the OMRON website to calculate the appropriate cumulative run time when the deterioration of electrolytic capacitors is expected.

Self-diagnostic Function

The following displays will appear if an error occurs.

Main display	Sub-display	Description	Output status	Correction method	Set value after reset
----- *4	No change	Present value underflow *2	No change	Either perform reset operation or turn ON reset input.	No change
FFFFF *4	No change	Present value overflow *3	No change	Either perform reset operation or turn ON reset input. *5	No change
E1	Not lit	CPU error	OFF	Either perform reset operation or reset the power supply.	No change
E2	Not lit	Memory error (RAM)	OFF	Turn ON the power again.	No change
E2	Sum	Memory error (non-volatile memory) *1	OFF	Reset operation	Factory setting
RPLC *7	No change	The cumulative run time or output ON count reaches the replacement time	No change	Reset operation *6	No change

*1. This includes times when the life of the non-volatile memory has expired.

*2. This occurs if the present value or total count value falls below -99999.

*3. This occurs in the following conditions if the present value (i.e., measurement value) exceeds 999999.

- For Output Modes K-2, D, L, or H
- Dual counter or tachometer operation is used.

*4. Display flashes.(1-second cycles)

*5. This does not apply when tachometer operation is used.

*6. This is displayed if the alarm value setting for either of the two outputs is exceeded if a model with two outputs is used. The total ON count will not be cleared by reset operation.

*7. The normal display and **RPLC** will appear alternately.

When reset operation is performed, **RPLC** will not be displayed even if the alarm set value is exceeded.

(Monitoring is possible, however, because the counter will continue without the cumulative run time and output ON count being cleared.)

RPLC is displayed again if the power is turned OFF/ON after the **RPLC** display is cleared during recovery by the reset operation. If you do not want to display **RPLC** when the power is turned OFF/ON, either change the alarm set value to the present value or above, or change the alarm set value to 0 to disable it.

Output ON Count Alarm Set Value ($\bar{\alpha}n - R, \bar{\alpha}n \uparrow R, \bar{\alpha}n \uparrow \bar{R}$)

Set the alarm value for the output ON count.

The limit can be set between 0×1000 (0 times) and 9999×1000 (9,999,000 times). Only the underlined values are set. The alarm will be disabled if 0 is set.

100,000 times is set in the default settings.

If the total output ON count reaches the alarm set value or above, an RPLC (replacement time) error can be displayed on the Timer.

H7CC-R□

H7CC-R□ Tachometer

- Equipped with a replacement time notification function.
- The white-color display further improves visibility and the color universal design is used. And the Up/Down Keys make it easier to use the Tachometer.
- Compatible with the ratings, characteristics, and functionality of the H7CX-R-N.



For the most recent information on models that have been certified for safety standards, refer to your OMRON website.

Specifications

Ratings

Classification		Tachometer			
Item	Model	H7CC-R11□		H7CC-R11W□	
Input mode		1 input only		2 inputs only	
Ratings	Power supply voltage *1	<ul style="list-style-type: none"> • 100 to 240 VAC, 50/60 Hz • 12 to 24 VDC or 48 VAC, 50/60 Hz 			
	Operating voltage fluctuation range	85% to 110% of rated supply voltage (90% to 110% at 12 to 48 VDC)			
	Power consumption	Approx. 6.8 VA at 100 to 240 VAC, Approx. 5.5 VA/ 3.3 W at 24 VAC/12 to 48 VDC			
Mounting method		Flush mounting or surface mounting			
External connections		11-pin socket			
Degree of protection		IEC IP66 for panel surface only and when Y92S-29 Waterproof Packing is used			
Input signals		Count and hold		Count 1 and count 2	
Pulse measurement method		Tachometer mode (cycle measurement)		AMD-compatible mode (continuous measurement)	
Maximum counting speed		30 Hz (minimum pulse width: 16.7 ms)	10 kHz (minimum pulse width: 0.05 ms)	---	
Minimum input signal width		---		10 ms	1 ms
Measuring ranges		0.001 Hz to 30.00Hz	0.001 Hz to 10 kHz	0.026 to 999999 s	0.003 to 999999 s
Sampling cycle		200 ms min.		Continuous measurement (minimum interval of 10 ms)	
Display refresh cycle		<ul style="list-style-type: none"> • Input pulse of 5 Hz min. Averaging not used: 200 ms Averaging used: 200 multiplied by the averaging setting (ms) • Input pulse of less than 5 Hz Averaging not used: Two times the maximum input pulse cycle Using averaging: Two times the maximum of the input pulse cycle multiplied by the averaging setting. 			
Measuring accuracy		±0.1% FS ±1 digit max. (at 23 ±5°C)			
Output mode		HI-LO, AREA, HI-HI, LO-LO		HI-HI, LO-LO	
Auto-zero time		0.1 to 999.9 s (in Tachometer Mode)			
Startup time		0.0 to 99.9 s			
Averaging		Simple averaging/moving averaging selectable, Number of times: OFF, 2, 4, 8 or 16 times			
Prescaling function		0.001 to 99.999 (in Tachometer Mode)			
Decimal point adjustment		Rightmost 3 digits		---	
Sensor waiting time		290 ms max. (Control output is turned OFF and no input is accepted during sensor waiting time.)			
Input	Input method	No-voltage Input Impedance when ON: 1 kΩ max. (Leakage current: 12 mA when 0 Ω) ON residual voltage: 3 V max. Impedance when OFF: 100 kΩ min. Voltage Input High (logic) level: 4.5 to 30 VDC Low (logic) level: 0 to 2 VDC (Input resistance: approx. 4.7 kΩ)			
	Hold input	Minimum input signal width: 20 ms		---	
External power supply		12 VDC (±10%), 100 mA * Refer to <i>Safety Precautions (Common)</i> on page 61 for details.			
Control output		Contact output: 3 A at 250 VAC/30 VDC, resistive load (cosφ=1) Minimum applied load: 10 mA at 5 VDC (failure level: P _r reference value)			
Display *2		7-segment, negative transmissive LCD Character height Present value: 10 mm (white), comparison value: 6 mm (green)			
Digits		6 digits (0 to 999999)			
Memory backup		Non-volatile memory (overwrites: 100,000 times min.) that can store data for 10 years min.			
Operating temperature range		-10 to 55°C (-10 to 50°C if Counter/Tachometers are mounted side by side) (with no icing or condensation)			
Storage temperature range		-25 to 70°C (with no icing or condensation)			
Operating humidity range		25% to 85%			
Case color		Black (N1.5)			

*1. Do not use the output from an inverter as the power supply. The ripple must be 20% maximum for CC power.
*2. The display is lit only when the power is ON. Nothing is displayed when power is OFF.

Characteristics

Insulation resistance		100 MΩ min. (at 500 VDC) between current-carrying terminal and exposed non-current-carrying metal parts, and between non-continuous contacts
Dielectric strength		2,000 VAC, 50/60 Hz for 1 min between current-carrying metal parts and non-current-carrying metal parts 2,000 VAC (for 100 to 240 VAC), 50/60 Hz for 1 min between power supply and input circuit (1,500 VAC for 24 VAC/12 to 48 VDC) 2,000 VAC 50/60 Hz for 1 min between control output, power supply, and input circuit 1,000 VAC, 50/60 Hz for 1 min between non-continuous contacts
Impulse withstand voltage		6.0 kV (between power terminals) for 100 to 240 VAC, 1.0 kV for 24 VAC/12 to 48 VDC 6.0 kV (between current-carrying terminal and exposed non-current-carrying metal parts) for 100 to 240 VAC, 1.5 kV for 24 VAC/12 to 48 VDC
Static immunity		Destruction: 15 kV, Malfunction: 8 kV
Vibration resistance	Destruction	10 to 55 Hz with 0.75-mm single amplitude, each in three directions for 2 hours
	Malfunction	10 to 55 Hz with 0.35-mm single amplitude, each in three directions for 10 min
Shock resistance	Destruction	300m/s ² each in three directions, three cycles
	Malfunction	100m/s ² each in three directions, three cycles
Life expectancy		Mechanical: 10,000,000 operations min. Electrical: 100,000 operations min. (3 A at 250 VAC, resistive load, ambient temperature condition: 23°C) *
Weight		Approx. 100 g (Tachometer only)

* See Life-test Curve (Reference Values) on the right.

Applicable Standards

Approved safety standards	cULus (or cURus): UL508/CSA C22.2 No. 14 *1 Conforms to EN 61010-1 (IEC 61010-1): Pollution degree 2/overvoltage category II, EAC, RCM, B300 PILOT DUTY, 1/4 HP 120 VAC, 1/3 HP, 240 VAC, 3-A, 250 VAC/30 VDC resistive load VDE0106/part100	
EMC	(EMI)	EN61326-1 *2
	Emission Enclosure:	EN55011 Group 1 classA
	Emission AC mains:	EN55011 Group 1 classA
	(EMS)	EN61326-1 *2
	Immunity ESD:	EN61000-4-2: 4 kV contact discharge (level 2); 8 kV air discharge (level 3)
	Immunity RF-interference:	EN61000-4-3: 10 V/m (Amplitude-modulated, 80 MHz to 1 GHz) 3 V/m (Amplitude-modulated, 1.4 G to 2 GHz) 1 V/m (Amplitude-modulated, 2 G to 2.7 GHz) 10 V/m (Pulse-modulated, 900 MHz ±5 MHz)
	Immunity Conducted Disturbance:	EN61000-4-6: 10 V (0.15 to 80 MHz) (level 3)
	Immunity Burst:	EN61000-4-4: 2 kV power-line (level 3); 1 kV I/O signal-line (level 4)
	Immunity Surge:	EN61000-4-5: 1 kV line to lines (power and output lines) (level 2); 2 kV line to ground (power and output lines) (level 3)
	Immunity Voltage Dip/Interruption:	EN61000-4-11: Voltage Dip 1 cycle, 100%(rated voltage) 10/12 cycle, 60%(rated voltage) 25/30 cycle, 30%(rated voltage) Interruption 250/300 cycle, 100%(rated voltage)

*1. The following safety standards apply to the H7CC-R11□.

cUL (Listing): Applicable when an OMRON P2CF(-E) Socket is used.

cUR (Recognition): Applicable when any other socket is used.

*2. Industrial electromagnetic environment (EN/IEC 61326-1 Table 2)

I/O Functions

Inputs	Count, count 1, count 2	Reads counting signals.
	Hold	<ul style="list-style-type: none"> • Holds the measurement value and outputs. • The hold indicator is lit during hold. *
Outputs	OUT, OUT1, OUT2	Outputs signals according to the specified output mode when a comparison value is reached.

* Refer to page 59 for details on the hold function.

Life-test Curve (Reference Values)

Resistive Load

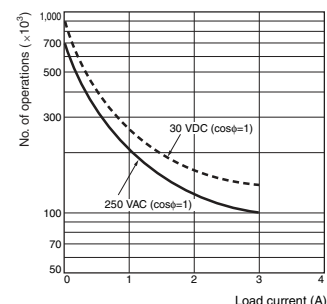

Inductive Load

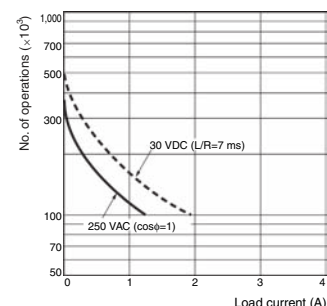

A current of 0.15 A max. can be switched at 125 VDC (cosφ=1) (Life expectancy: 100,000 operations)

A current of 0.1 A max. can be switched if L/R=7 ms. (Life expectancy: 100,000 operations)

H7CC-R□

Connections

Terminal Arrangement

H7CC-R11
H7CC-R11D

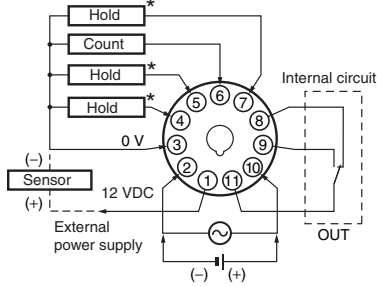

* The hold function is the same whichever terminal is connected. Terminals are not connected internally, and so do not use them for cross-over wiring.

H7CC-R11W
H7CC-R11WD

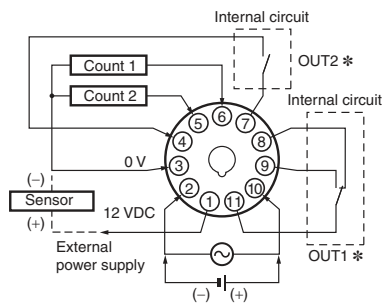

* OUT1/OUT2 can be switched during output allocation.

Block Diagram

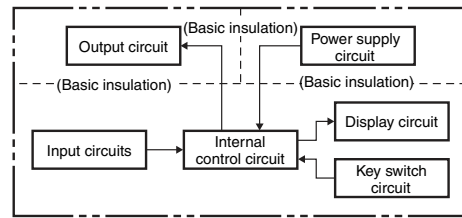

Input Circuits

Count and Hold Inputs

No-voltage Inputs (NPN Inputs)

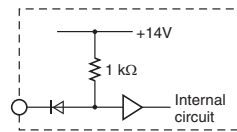

Voltage Inputs (PNP Inputs)

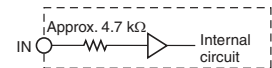

Input Connections

The inputs of the H7CC-R are no-voltage (short-circuit or open) inputs or voltage inputs. They are set for use as voltage inputs at the time of delivery.

No-voltage Inputs (NPN Inputs)

Open Collector

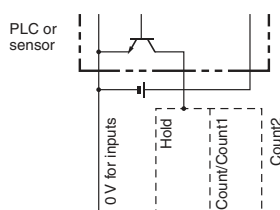

H7CC-R11□	③	④⑤⑦	⑥	---
H7CC-R11W□	③	---	⑥	⑤

Note: Operates when the transistor turns ON.

Voltage Output

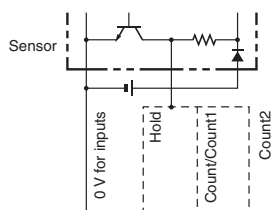

H7CC-R11□	③	④⑤⑦	⑥	---
H7CC-R11W□	③	---	⑥	⑤

Note: Operates when the transistor turns ON.

Contact Input

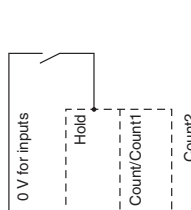

H7CC-R11□	③	④⑤⑦	⑥	---
H7CC-R11W□	③	---	⑥	⑤

Note: Operates when the contact turns ON.

DC Two-wire Sensor

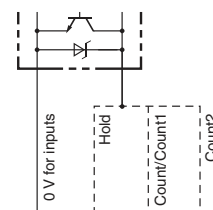

H7CC-R11□	③	④⑤⑦	⑥	---
H7CC-R11W□	③	---	⑥	⑤

Note: Operates when the transistor turns ON.

No-voltage Input Signal Levels

No-contact input	Short-circuit level (Transistor ON)
	<ul style="list-style-type: none"> Residual voltage: 3 V max. Impedance when ON: 1 kΩ max. (The leakage current is approx. 12 mA when the impedance is 0 Ω.)
Contact input	Open level (Transistor OFF)
	<ul style="list-style-type: none"> Impedance when OFF: 100 kΩ min.

Note: The DC voltage must be 30 VDC max.

Applicable Two-wire Sensor	
• Leakage current: 1.5 mA max.	
• Switching capacity: 5 mA min.	
• Residual voltage: 3 VDC max.	
• Operating voltage: 10 VDC	

Voltage Inputs (PNP Inputs)

No-contact Input (NPN Transistor)

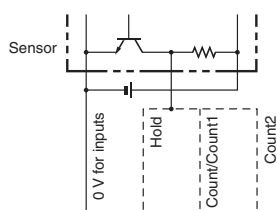

H7CC-R11□	③	④⑤⑦	⑥	---
H7CC-R11W□	③	---	⑥	⑤

Note: Operates when the transistor turns ON.

No-contact Input (PNP Transistor)

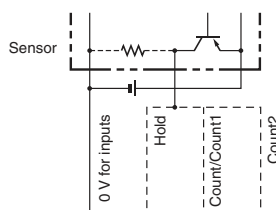

H7CC-R11□	③	④⑤⑦	⑥	---
H7CC-R11W□	③	---	⑥	⑤

Note: Operates when the transistor turns ON.

Contact Input

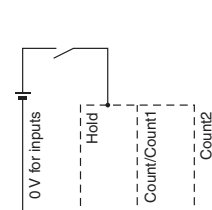

H7CC-R11□	③	④⑤⑦	⑥	---
H7CC-R11W□	③	---	⑥	⑤

Note: Operates when the contact turns ON.

Voltage Input Signal Levels

High level (Input ON): 4.5 to 30 VDC
Low level (Input OFF): 0 to 2 VDC

- Note: 1. The DC voltage must be 30 VDC max.
2. Input resistance: Approx. 4.7 kΩ

Nomenclature

Display Section

- 1. Hold Indicator (yellow)**
(Lit when hold operation is performed.)
- 2. Key Protect Indicator (yellow)**
Lit when the key protect switch is ON.
- 3. Control Output Indicator (yellow)**
OUT (1-output models)
OUT 1 2 (2-output models)
- 4. Comparison Value 1, 2 Stage Indicator**
- 5. Present Value (Main Display)**
Character height: 10 mm (white)
- 6. Comparison Value (Sub-display)**
Character height: 6 mm (green)

Character Size
for Main Display

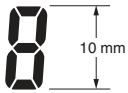

Character Size
for Sub-display

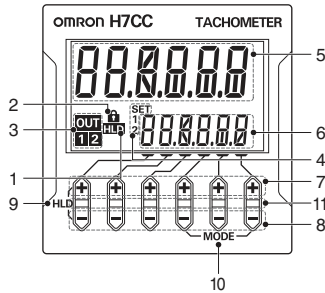
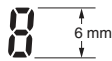

Operation Keys

- 7. Up Keys (UP1 to UP6)**
(UP1, 2, 3, 4, 5, 6 from right to left)
- 8. Down Keys (DW1 to DW6)**
(DW1, 2, 3, 4, 5, 6 from right to left)
- 9. Hold Operation (UP6+DW6)**
(The hold operation is enabled by pressing and holding the keys for 1 second or longer. When the keys are pressed simultaneously, all status indicators start blinking. The hold operation is disabled if the keys are released within 1 second.)
To perform the hold operation, firmly press and hold both UP6 and DW6. If you press only UP6 or DW6, the set value will change.
- 10. Mode Operation (UP1+UP3 or DW1+DW3)**
(Changes modes and setting items. Press and hold the keys for 2 seconds or longer to move to the function setting mode. When the keys are pressed simultaneously, the status indicators on UP1 (DW1) and UP3 (DW3) start blinking. The mode operation is disabled if the keys are released within 2 seconds.)

11. Status indicator

- <When Run mode is not selected.>
 - When the indicator display mode is ON
If "Upper and lower limit" or "Area" is selected in the tachometer output mode, the ratio of the measurement value to the comparison value is displayed from 0 to 100%.
 - When the indicator display mode is all off or all lit
All off or all lit display.
- Note.** When you press the Up Key or the Down Key, the indicator display or all-lit display goes off, and the pressed key lights up or blinks.
- <When Function Setting Mode is not selected>
 - The keys that can be set light up for notification.

Switches

12. Key-protect Switch

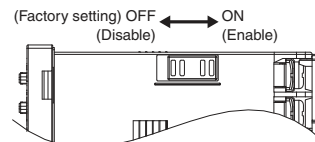

Dimensions

Tachometers

Dimensions without Flush Mounting Adapter

H7CC-R□

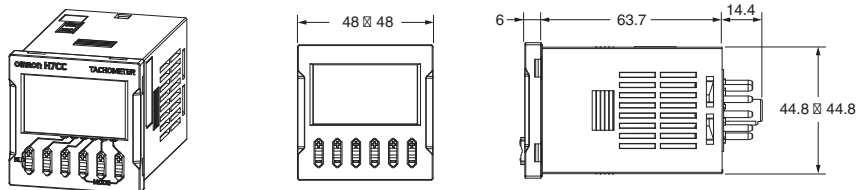

Panel Cutouts

Panel cutouts are as shown below (according to DIN43700).

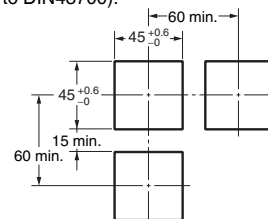

- Note:**
1. The mounting panel thickness should be 1 to 5 mm.
 2. To allow easier operation, it is recommended that Adapters be mounted so that the gap between sides with hooks is at least 15 mm (i.e., with the panel cutouts separated by at least 60 mm).
 3. It is possible to horizontally mount Timers side by side. Attach the Flush Mounting Adapters so that the surfaces without hooks are on the sides of the Timers. If Counters/Tachometers are mounted side by side, however, water resistance will be lost.

Dimensions with Flush Mounting Adapter (Adapter and Waterproof Packing Ordered Separately)

H7CC-R□

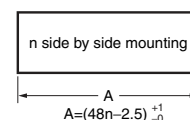
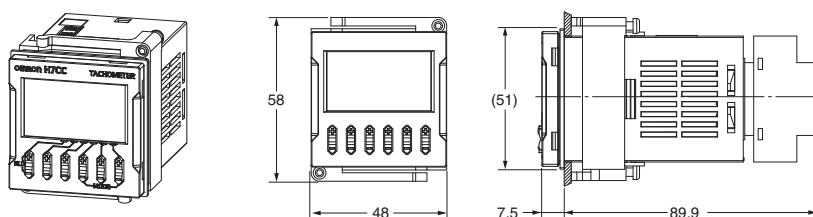

With Y92A-48F1 attached.
 $A = (48n - 2.5 + (n - 1) \times 4) +1/0$
 With Y92A-48 attached.
 $A = (51n - 5.5) +1/0$

Dimensions with Front Connecting Socket

H7CC-R□

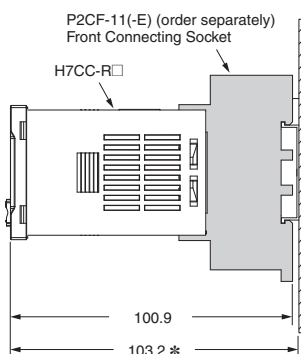

* These dimensions vary with the kind of DIN track (reference value).

Accessories (Order Separately)

Note: Depending on the operating environment, the condition of resin products may deteriorate, and may shrink or become harder. Therefore, it is recommended that resin products are replaced regularly.

Soft Cover Y92A-48F1

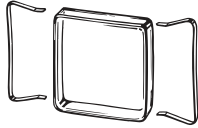

Hard Cover Y92A-48

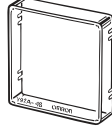

Protecting the Counter/Tachometer in Environments Subject to Oil

The H7CC's panel surface is water-resistive (conforming to IP□6) and so even if drops of water penetrate the gaps between the keys, there will be no adverse effect on internal circuits. If, however, there is a possibility of oil being present on the operator's hands, use the Soft Cover. The Soft Cover ensures protection equivalent to IP54F against oil. Do not, however, use the H7CC in locations where it would come in direct contact with oil.

Waterproof Packing Y92S-29

Note: The Waterproof Packing is included with models with screw terminals.

Order the Waterproof Packing separately if it is lost or damaged. The Waterproof Packing can be used to achieve IP66 protection.

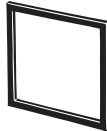

The panel surface of the H7CC-A/-R is water-resistant (conforming to IP66). To protect the internal circuits from water penetration through the space between the H7CC and operating panel, waterproof packing is included. Attach the Y92F-30 Adapter with sufficient pressure with the reinforcing screws so that water does not penetrate the panel.

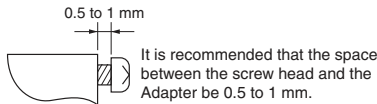

The Waterproof Packing will deteriorate, harden, and shrink depending on the application environment. To ensure maintaining the IP□6 waterproof level, periodically replace the Waterproof Packing. The periodic replacement time will depend on the application environment. You must confirm the proper replacement time. Use 1 year or less as a guideline. If the Waterproof Packing is not replaced periodically, the waterproof level will not be maintained. It is not necessary to mount the Waterproof Packing if waterproof construction is not required.

Flush Mounting Adapter Y92F-30

Order the Flush Mounting Adapter with the following model number separately if it is lost or damaged.

Note: The Waterproof Packing is included with models with screw terminals.

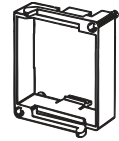

Y92F-45

Note: 1. The adapter is black in color.

2. The Y92F-45 can be used in combination with the Y92F-30 Adapter provided with the Tachometer.

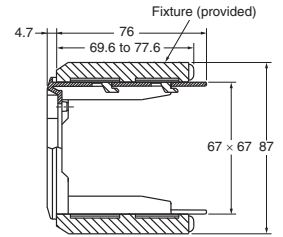
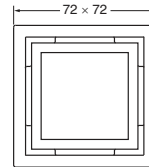
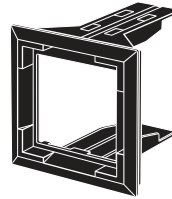

<H7CC Mounting Example>

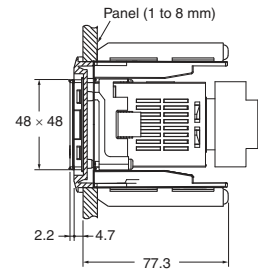
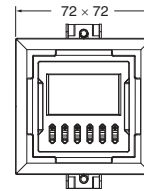
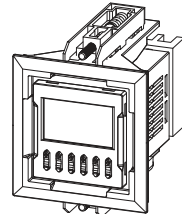

Connection Sockets

Refer to *Connection Sockets* on page 13 for details.

Optional Products for Track Mounting

Refer to *Optional Products for Track Mounting* on page 14 for details.

Operating Procedures

Parameters can be set with the operation keys on the front panel. Refer to the following for the detailed procedure.

Step1

The H7CC-R□ is a Counter that contains more than one functional counter. When using the Counter in any mode other than the default mode, use the following chart to enter Configuration Selection Mode and set the functions that are suitable to the application. (Default mode: Tachometer)

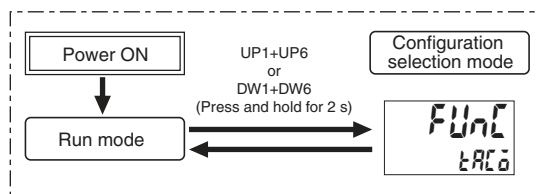

Select the function using the UP1 Key (DW1 Key). (H7CC-R11□ only)

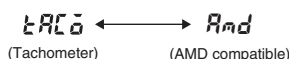

Step2

Parameters are set with the operation keys on the front panel.

Change to Function Setting Mode.

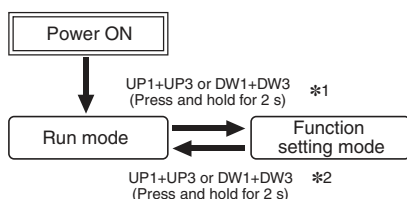

For details on operations in run mode, refer to page 55.

- *1 If the mode is switched to the function setting mode during operation, operation will continue.
- *2 Changes made to settings in function setting mode are enabled for the first time when the mode is changed to run mode. Also, when settings are changed, the counter is reset (present value initialized and output turned OFF) on returning to run mode.

The characters displayed in reverse video are the default settings. In the function setting mode, the status indicator of the keys that can be set lights up. (Example) In the case of the prescale value (PSCL) A value from 0.001 to 99.999 can be set, and therefore, the status indicator of the UP1 Key to UP5 Key (DW1 Key to DW5 Key) lights up.

* Use UP1+UP3 to move up and DW1+DW3 to move down

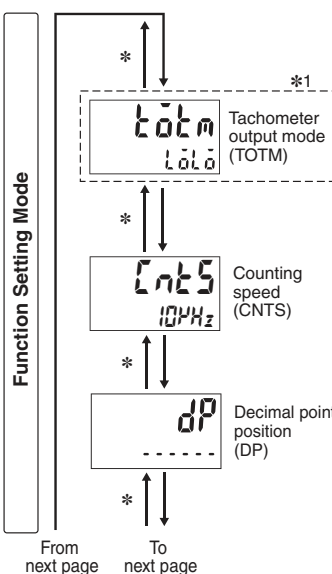
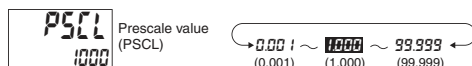

- Set the tachometer output mode using the UP1 Key (DW1 Key).

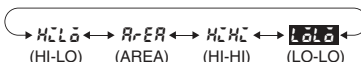

Note: The indicator display is disabled during the upper or lower limit setting.

- Set the counting speed using the UP1 Key (DW1 Key).

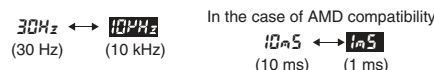

- Set the decimal point position using the UP1 Key (DW1 Key).

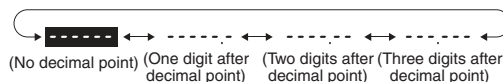

- *1. In the case of the -R11W□ type, set the tachometer output mode 1 or 2 with the UP or DOWN Key.

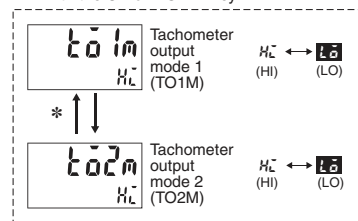

Function Setting Mode

* Use UP1+UP3 to move up and DW1+DW3 to move down

To previous page
From previous page

* ↑ ↓

PSCL
Prescale value (PSCL)
 0.000

• Set each digit using the individual UP1 to UP5 Keys (DW1 to DW5 Keys).

→ 0.00 1 ~ 9999 ←
(0.001) (1.000) (99.999)

Note: Not displayed in AMD-compatible mode.

AVGT
Averaging method (AVGT)
 5mP

• Set the averaging method using the UP1 Key (DW1 Key).

5mP ↔ mV
(SMP) (MV)
(Simple averaging) (Moving average)

AVGN
Average processing (AVGN)
 0FF

• Set the number of averaging times using the UP1 Key (DW1 Key).

→ 0FF ↔ 2 ↔ 4 ↔ 8 ↔ 16 ←
(No average processing) (Average of 2 measurements) (Average of 4 measurements) (Average of 8 measurements) (Average of 16 measurements)

AUTO0
Auto-zero time (AUTO0)
 9999

• Set each digit using the individual UP1 to UP4 Keys (DW1 to DW4 Keys).

→ 0.1 ~ 999.9 ←
(0.1 s) (999.9 s)

Note: Not displayed in AMD-compatible mode.

STMR
Startup time (STMR)
 00

• Set each digit using the individual UP1 to UP3 Keys (DW1 to DW3 Keys).

→ 0.0 ~ 99.9 ←
(0.0 s) (99.9 s)

IMOD
NPN/PNP input mode (IMOD)
 PnP

• Set the NPN/PNP input mode using the UP1 Key (DW1 Key).

nPn ↔ PnP
(NPN input) (PNP input)

DHLD
Peak/bottom hold enabled (DHLD)
 0FF

• Enable or disable the peak/bottom hold using the UP1 Key (DW1 Key).

0FF ↔ 0n
(Disabled) (Enabled)

HYS
Output hysteresis (HYS)
 0

• Set the output hysteresis using the UP1 to UP5 Keys (DW1 to DW5 Keys).

→ 0 ~ 99999 ←
(0) (99999)

Note: The position of the decimal point for the value after prescaling will be set according to the decimal point position setting.

OFFD
Output OFF delay (OFFD)
 0.00

• Set each digit using the individual UP1 to UP4 Keys (DW1 to DW4 Keys).

→ 0.00 ~ 19.99 ←
(0.00 s) (19.99 s)

SL-H
Set value upper limit (SL-H)
 999999

• Set each digit using the individual UP1 to UP6 Keys (DW1 to DW6 Keys).

→ 1 ~ 999999 ←
(1) (999999)

Note: The position of the decimal point for the value after prescaling will be set according to the decimal point position setting.

OTST
Output Allocation (OTST)
 0FF

• Set the output allocation using the UP1 Key (DW1 Key).

0FF ↔ 0n
(OFF) (ON)

Note: OFF: Output 1 (OUT1) = 8, 9, 11 Output 2 (OUT2) = 4, 7 /
 ON: Output 1 (OUT1) = 4, 7 Output 2 (OUT2) = 8, 9, 11 (The numbers are the terminals numbers.)

KYPT
Key protect level (KYPT)
 KP-1

• Set the key protect level using the UP1 Key (DW1 Key).

→ KP-1 ↔ KP-2 ↔ KP-3 ↔ KP-4 ↔ KP-5 ↔ KP-6 ↔ KP-7 ←
(KP-1) (KP-2) (KP-3) (KP-4) (KP-5) (KP-6) (KP-7)

From next page
To next page

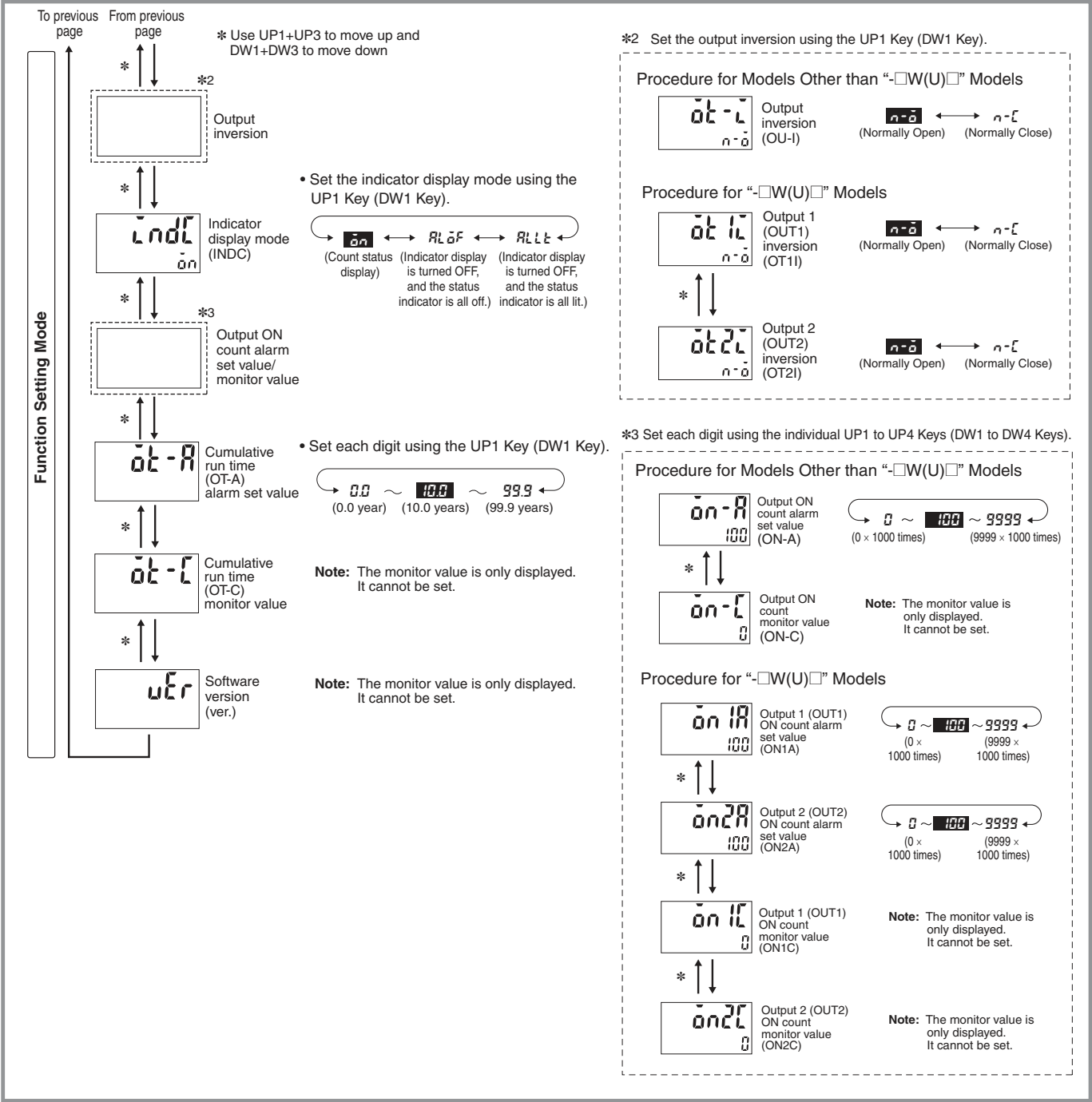

Explanation of Functions

Basic Functions

Pulse Measurement Method (F_Un_L)

The mode can be switched between tachometer mode and AMD-compatible mode.

Tachometer Mode (t_RL_ā)

Use this mode to measure the pulse frequency (Hz).

AMD-compatible Mode (R_nd)

Use this mode to measure the pulse cycle (s).

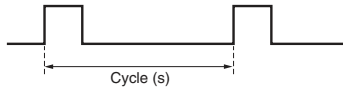

Counting Speed (L_nt₅)

Set the maximum counting speed (30 Hz/10 kHz) for input. If contacts are used for input signals, set the counting speed to 30 Hz.

Processing to eliminate chattering is performed for this setting.

Output Mode (t_āt_n)

Set the output method for control output based on the comparison value.

Upper and lower limit (HI-LO), area (AREA), upper limit (HI), and lower limit (LO) can be set. For the H7CC-RW□, the upper limit (HI-HI) and lower limit (LO-LO) can be set. (For details on the operation of the output modes, refer to *Output Mode Settings* on page 58.)

Averaging Method (R_uL_t)

Simple averaging (SMP) or a moving average (MV) can be selected for the averaging method.

With a moving average, the average measurement value is displayed every sampling cycle or pulse cycle, in contrast to simple averaging, for which the average value is displayed for the set number of samples.

Number of Averaging Times (R_uL_n)

Flickering display and output chattering can be prevented using average processing. Average processing can be set to one of five levels: no average processing, 2 times (i.e., the average of 2 measurement values), 4 times, 8 times, or 16 times.

For a measurement frequency of 5 Hz or higher using a tachometer, the average will be equal to the sampling cycle (200 ms) multiplied by the averaging setting (i.e., the number of times).

For less than 5 Hz, the frequency will be measured when the input pulse comes. Average processing produces a stable display even for fluctuating input signals. Set the optimum number of times for the application.

If AMD-compatible mode is used, the measurement cycle will be measured when the input pulse is received. The output will change, however, when the comparison value is exceeded even if averaging is enabled.

NPN/PNP Input Mode (L_nā_d)

Select either NPN input (no-voltage input) or PNP input (voltage input) as the input format. When using a two-wire sensor, select NPN input.

The same setting is used for all external inputs.

For details on input connections, refer to *Input Connections* on page 45.

Advanced Functions

Decimal Point Position (d^P)

Decide the decimal point position for the measurement value and comparison value.

Prescale Value (P₅L_L)

It is possible to display the rate of rotation or the speed of a device or machine to which the H7CC is mounted by converting input pulses to a desired unit.

If the default prescaling value (1,000) is used, the input frequency (Hz) will be displayed.

The relationship between display and input is determined by the following equation. Set the prescale value according to the unit to be displayed.

$$\text{Displayed value} = f \times \alpha$$

f: Input pulse frequency (number of pulses in 1 second)

α: Prescale value

(1) Displaying Rotation Rate

Display unit	Prescale value (α)
rpm	1/N × 60
rps	1/N

N: Number of pulses per revolution

Example: In order to display the rate of rotation for a machine that outputs 5 pulses per revolution in the form □□.□ rpm:

1. Set the decimal point position to 1 decimal places.

2. Using the formula, set the prescale value (α) to

$$1/N \times 60 = 60/5 = 12.$$

(2) Displaying Speed

Display unit	Prescale value (α)
m/min	$\pi d \times 1/N \times 60$
m/s	$\pi d \times 1/N$

N: Number of pulses per revolution

d: Diameter of rotating body (m)

πd: Circumference (m)

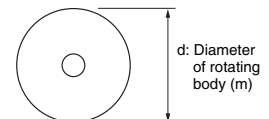

- Observe the following points when setting a prescale value. Set the set value to a value less than {Maximum countable value – Prescale value}.
Example:
If the prescale value is 1.25 and the counting range is 0.000 to 999.999, set the set value to a value less than 998.749 (= 999.999 – 1.25).
If the set value is set to a value greater than this, output will not turn ON.

Note: If the prescale value setting is incorrect, a counting error will occur. Check that the settings are correct before using this function.

Auto-zero Time (RUL 00)

It is possible to make the settings so that the frequency will be forced to 0 if there is no pulse for a specified period of time. This time is called the auto-zero time.

Note: Set the auto-zero time to a time slightly longer than the estimated interval between input pulses. It will not be possible to make accurate measurements if the auto-zero time is set to a time shorter than the input pulse cycle. Setting a time that is too long may also result in problems, such as a time-lag between rotation stopping and the alarm turning ON.

Startup Time (St nr)

In order to prevent undesired output resulting from unstable input immediately after the power supply is turned ON, measurement can be prohibited for a set time at startup.

It can also be used to stop measurement and disable output until the rotating body reaches the normal rate of rotation, after the power supply to the H7CC and rotating body are turned ON at the same time.

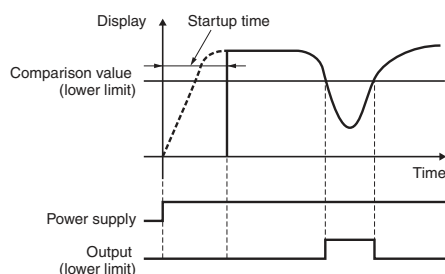
**Peak/bottom Hold Enabled (dHL d)**

This function records the peak and bottom (i.e., minimum) values after counting starts (after turning ON the power supply or changing the configuration selection mode or function setting).

The peak value is also held when the power supply is interrupted.

Output Hysteresis (HY5)

This setting can be used to prevent output chattering if the measurement value fluctuates slightly near the set value.

In Tachometer Mode, the measurement value after prescaling is set.

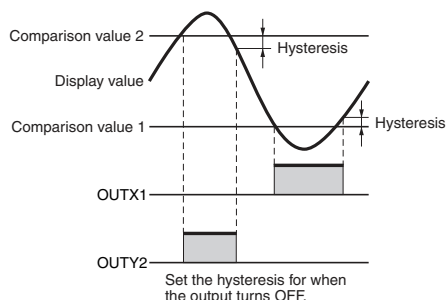
**Output OFF Delay (OFF d)**

This function delays the timing for turning OFF comparative output by a certain time.

The ON time can be held for the set time if the comparative result changes in a short time.

Operation will continue and outputs will not change while holding the value.

Set Value Upper Limit (SL -H)

Set the upper limit for the set value when it is set in run mode.

Key Protect Level (YPL)

Set the key protect level.

Refer to *Key Protect Level* on page 56.

Output ON Count Alarm Set Value (on-R, on IR, on2R)

The output ON count for notifying the replacement time can be set. For details, refer to page 57.

Output ON Count Monitor Value (on-L)

The monitor value is only displayed. It cannot be set.

The output ON count will be 1,000 times the displayed value.

ON Count Monitor Values for Outputs 1 and 2 (OUT1 and OUT2) (on IL and on2L)

The monitor value for output 1 and 2 (OUT1 and OUT2) is only displayed. It cannot be set.

The output ON count will be 1,000 times the displayed value.

Output Allocation (at 5t)

Set the allocation of outputs 1 and 2 (OUT1 and OUT2). If output allocation is OFF, output 1 (OUT1) is allocated to terminals (8), (9), and (11), and output 2 (OUT2) is allocated to terminals (4) and (7). If output allocation is ON, output 1 (OUT1) is allocated to terminals (4) and (7), and output 2 (OUT2) is allocated to terminals (8), (9), and (11).

Output inversion (at -L, at IL, at2L)

Set logical inversion of output ON/OFF. In the case of two outputs, it is possible to individually set output inversion for each of output 1 and output 2 (OUT1 and OUT2). If output inversion is \bar{a} (Normally Open), the output turns ON when the set value is reached. If output inversion is \bar{L} (Normally close), the output turns OFF when the set value is reached.

Indicator Display Mode (ꠁꠁꠁ)

Settings can be made to display the measurement value in status indicator. When this mode is ON, and "Upper and lower limit" or "Area" has been selected in the tachometer output mode, the status indicator changes in accordance with the ratio of the measurement value to the comparison value. In the case of ALOF, the indicator display is turned OFF, and the status indicator is all off. In the case of ALLT, the indicator display is turned OFF, and the status indicator is all lit.

(Example 1) When the upper and lower limits have been selected
 The status indicator lights up when the status reaches 1/6, 2/6, 3/6 (50%), 4/6, 5/6, 6/6 (100%) in accordance with the ratio of the measurement value to the comparison value. If comparison value 1 = 2000 and comparison value 2 = 2300 have been set, all status indicators are off when the measurement value is below 2050, the three status indicators on the left light up when the measurement value reaches 2150, and all status indicators light up when the measurement value becomes 2300 or more.

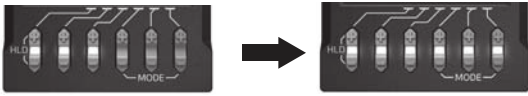

Three indicators light up when the status reaches 50%

All indicators light up when the status reaches 100%

Cumulative Run Time Alarm Set Value (ꠁꠁ - ꠁ)

The cumulative run time for notifying the replacement time can be set. For details, refer to page 57.

Cumulative Run Time Monitor (ꠁꠁ - ꠁ)

The cumulative run time is displayed. It is not a setting item. The numerical values are displayed in increments of 0.1 years.

Operation in Run Mode

- Set each digit using the individual UP1 to UP6 Keys (DW1 to DW6 Keys).



H7CC-R11□

Output Mode: HI or LO

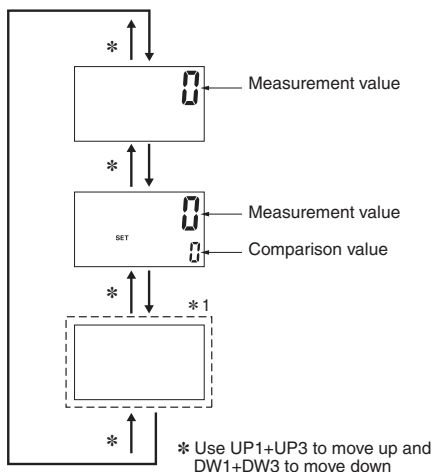

Output Mode: HI-LO or AREA

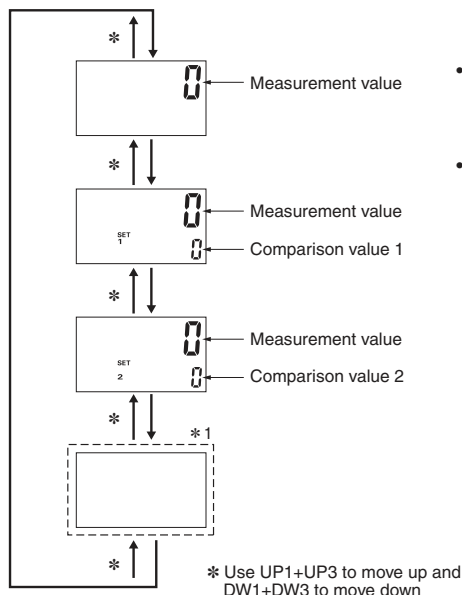

- Measurement Value**
Displays the currently measured value.
- Comparison Value, Comparison Value 1, and Comparison Value 2**
Set the comparison value, comparison value 1, and comparison value 2. The measurement value is compared to comparison value, comparison value 1, and comparison value 2 and an output is made according to the selected output mode.

H7CC-R11W□

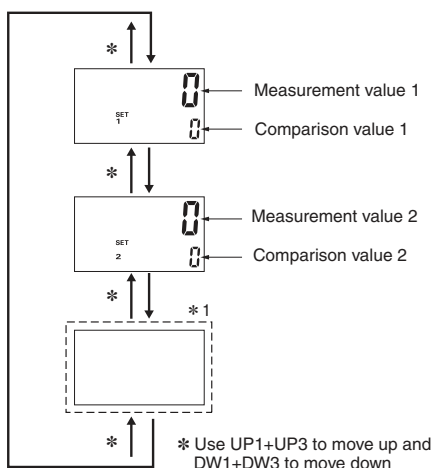

*1 Peak/bottom hold enabled

Displayed for Models Other Than "-W" Models

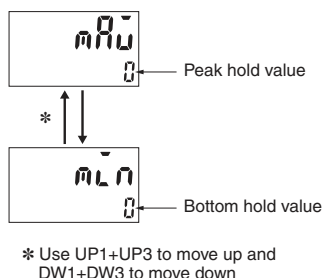

Displayed for "-W" Models

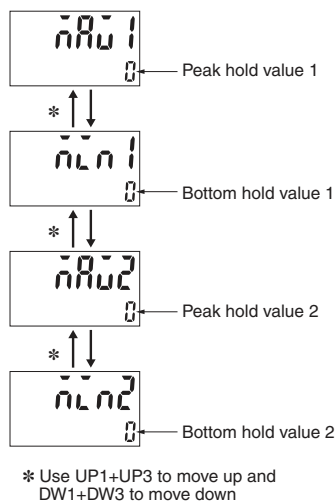

- Peak/bottom hold value**
The peak (maximum) and bottom (minimum) values are displayed after counting starts.
- Peak/bottom hold value 1 and 2**
Peaks (maximums) 1 and 2 and bottoms (minimums) 1 and 2 are displayed after counting starts.
- Note:** The hold values will be initialized when hold operation is performed or reset 1 input is turned OFF while peak/bottom hold values 1 and 2 are being displayed. (The reset 2 input operates in the same way if the input mode is set to 2-input mode.)

Key Protect Level

When the key-protect switch is set to ON, it is possible to prevent setting errors by prohibiting the use of certain operation keys by specifying the key protect level (KP-1 to KP-7). The key protect level is set in the function setting mode. The key protect indicator is lit when the key-protect switch is ON.

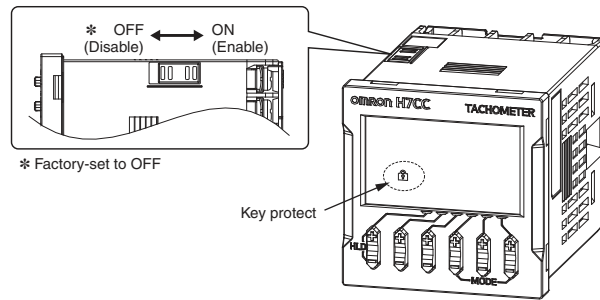

Level	Meaning	Details			
		Changing mode*	Switching display during operation	Hold operation	Up/Down Keys
KP-1 (default setting)		Invalid	Valid	Valid	Valid
KP-2		Invalid	Valid	Invalid	Valid
KP-3		Invalid	Valid	Valid	Invalid
KP-4		Invalid	Valid	Invalid	Invalid
KP-5		Invalid	Invalid	Invalid	Invalid
KP-6		Invalid	Invalid	Valid	Valid
KP-7		Invalid	Invalid	Invalid	Valid

* Changing mode to function setting mode.

Replacement Time Notification Function

The counter includes parts such as electrolytic capacitors and relays that deteriorate with time or with repeated operations.

The H7CC is equipped with a function for notifying the replacement time by the cumulative run time and ON count of the relay contact.

When either one of the deterioration of the electrolytic capacitors due to the cumulative run time or the deterioration of the relay contact due to the output ON count reaches the replacement time, **RPLC** (REPLACE) can be displayed on the Timer. For details on RPLC display, refer to *Self-diagnosis Function* on this page.

Cumulative Run Time Alarm Set Value ($\bar{\alpha}t - R$)

The cumulative run time can be set in a range from 0.0 to 99.9 years. The Replacement Time Notification Function is disabled if 0 is set. 10 years is set in the default settings.

If the cumulative run time reaches the alarm set value or above, an RPLC (replacement time) error can be displayed on the Timer.

The extent of deterioration of electrolytic capacitors varies depending on the capacitor temperature and usage period. According to the default settings, the ambient temperature is 35°C, the output load is 50%, and the utilization rate is 100%. If you are changing the actual usage conditions, enter the ambient temperature, output load, and utilization rate in the H7CC replacement time calculation tool available on the OMRON website to calculate the appropriate cumulative run time when the deterioration of electrolytic capacitors is expected.

Self-diagnostic Function

The following displays will appear if an error occurs.

Main display	Sub-display	Error	Output status	Correction method	Set value after reset
FFFFFF *3	No change	Measurement value overflow *2	No change	Measurement value ≤ 999999	No change
E1	Not lit	CPU	OFF	Either perform hold operation or reset the power supply.	No change
E2	Not lit	Memory error (RAM)	OFF	Turn ON the power again.	No change
E2	5Ln	Memory error (non-volatile memory) *1	OFF	Hold operation	Factory setting
RPLC *4	No change	The cumulative run time or output ON count reaches the replacement time	No change	Hold operation	No change

*1. This includes times when the life of the non-volatile memory has expired.

*2. Occurs when the measurement value reaches 999,999.

*3. Display flashes (1-second cycles).

*4. The normal display and **RPLC** will appear alternately.

When hold operation is performed, **RPLC** will not be displayed even if the alarm set value is exceeded. (Monitoring is possible, however, because the counter will continue without the cumulative run time and output ON count being cleared.)

RPLC is displayed again if the power is turned OFF/ON after the **RPLC** display is cleared during recovery by the hold operation. If you do not want to display **RPLC** when the power is turned OFF/ON, either change the alarm set value to the present value or above, or change the alarm set value to 0 to disable it.

Output ON Count Alarm Set Value ($\bar{\alpha}n - R, \bar{\alpha}n IR, \bar{\alpha}nZR$)

Set the alarm value for the output ON count.

The limit can be set between 0×1000 (0 times) and 9999×1000 (9,999,000 times). Only the underlined values are set. The alarm will be disabled if 0 is set.

100,000 times is set in the default settings.

If the total output ON count reaches the alarm set value or above, an RPLC (replacement time) error can be displayed on the Timer.

Output Mode Settings

Models Other Than H7CC-R11W□ in Tachometer Mode

Output mode setting	Operation						
Upper and lower limit	<p>ON condition: Measurement value \leq Comparison value 1 or Measurement value \geq Comparison value 2 Note: When comparison value 1 \geq Comparison value 2, the output is always ON regardless of the comparison value.</p>						
Area	<table border="1"> <thead> <tr> <th>Condition</th> <th>Comparison value 1 \leq Comparison value 2</th> <th>Comparison value 1 $>$ Comparison value 2</th> </tr> </thead> <tbody> <tr> <th>ON condition</th> <td>Comparison value 1 \leq measurement value \leq Comparison value 2</td> <td>Comparison value 2 \leq measurement value \leq Comparison value 1</td> </tr> </tbody> </table>	Condition	Comparison value 1 \leq Comparison value 2	Comparison value 1 $>$ Comparison value 2	ON condition	Comparison value 1 \leq measurement value \leq Comparison value 2	Comparison value 2 \leq measurement value \leq Comparison value 1
Condition	Comparison value 1 \leq Comparison value 2	Comparison value 1 $>$ Comparison value 2					
ON condition	Comparison value 1 \leq measurement value \leq Comparison value 2	Comparison value 2 \leq measurement value \leq Comparison value 1					
Upper limit	<p>ON condition: Measurement value \geq Comparison value</p>						
Lower limit	<p>ON condition: Measurement value \leq Comparison value</p>						

Models Other Than H7CC-R11W□ in AMD-compatible Mode

Output mode setting	Operation						
Upper and lower limit	<p>ON condition: Measurement value $<$ Comparison value 1 or Measurement value \geq Comparison value 2 Note: When comparison value 1 \geq comparison value 2, the output is always ON regardless of the comparison value.</p>						
Area	<table border="1"> <thead> <tr> <th>Condition</th> <th>Comparison value 1 \leq Comparison value 2</th> <th>Comparison value 1 $>$ Comparison value 2</th> </tr> </thead> <tbody> <tr> <th>ON condition</th> <td>Comparison value 1 \leq measurement value $<$ Comparison value 2</td> <td>Comparison value 2 \leq measurement value $<$ Comparison value 1</td> </tr> </tbody> </table>	Condition	Comparison value 1 \leq Comparison value 2	Comparison value 1 $>$ Comparison value 2	ON condition	Comparison value 1 \leq measurement value $<$ Comparison value 2	Comparison value 2 \leq measurement value $<$ Comparison value 1
Condition	Comparison value 1 \leq Comparison value 2	Comparison value 1 $>$ Comparison value 2					
ON condition	Comparison value 1 \leq measurement value $<$ Comparison value 2	Comparison value 2 \leq measurement value $<$ Comparison value 1					
Upper limit	<p>ON condition: Measurement value \geq Comparison value</p>						
Lower limit	<p>ON condition: Measurement value $<$ Comparison value</p>						

Note: If time "a" is exceeded during operation, the output will turn ON. If time "b" is exceeded during operation, the output will turn OFF. (If average processing is enabled, the output operation will be performed when the time is exceeded once.)

H7CC-R11W□

Output mode setting	Operation
Upper limit (HI)	<div style="display: flex; justify-content: space-around;"> <div style="text-align: center;"> <p>Output 1</p> <p>ON condition for output 1: CP1 present value (display value) \geq Comparison value 1</p> </div> <div style="text-align: center;"> <p>Output 2</p> <p>ON condition for output 2: CP2 present value (display value) \geq Comparison value 2</p> </div> </div>
Lower limit (LO)	<div style="display: flex; justify-content: space-around;"> <div style="text-align: center;"> <p>Output 1</p> <p>ON condition for output 1: CP1 present value (display value) \leq Comparison value 1</p> </div> <div style="text-align: center;"> <p>Output 2</p> <p>ON condition for output 2: CP2 present value (display value) \leq Comparison value 2</p> </div> </div>

Precautions for the H7CC-R

In upper and lower limit output mode, if the comparison value setting is such that comparison value 1 \geq comparison value 2, the output will always be ON.

Hold Function

The measurement value (display value) and output are sustained while the hold input is ON.

Note: The output will maintain the current status when hold operation is performed.

Example:

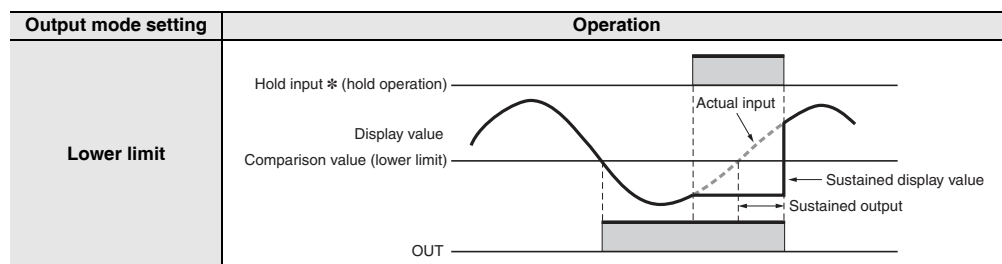

* The H7CC-R11W□ does not have a hold input.

Precautions on Replacing the AMD-S

The H7CC-R11 is the recommended model for replacing the AMD-S-series Motion Detector. Refer to the following precautions before replacing the AMD-S.

Terminal Arrangement and Wiring Connections

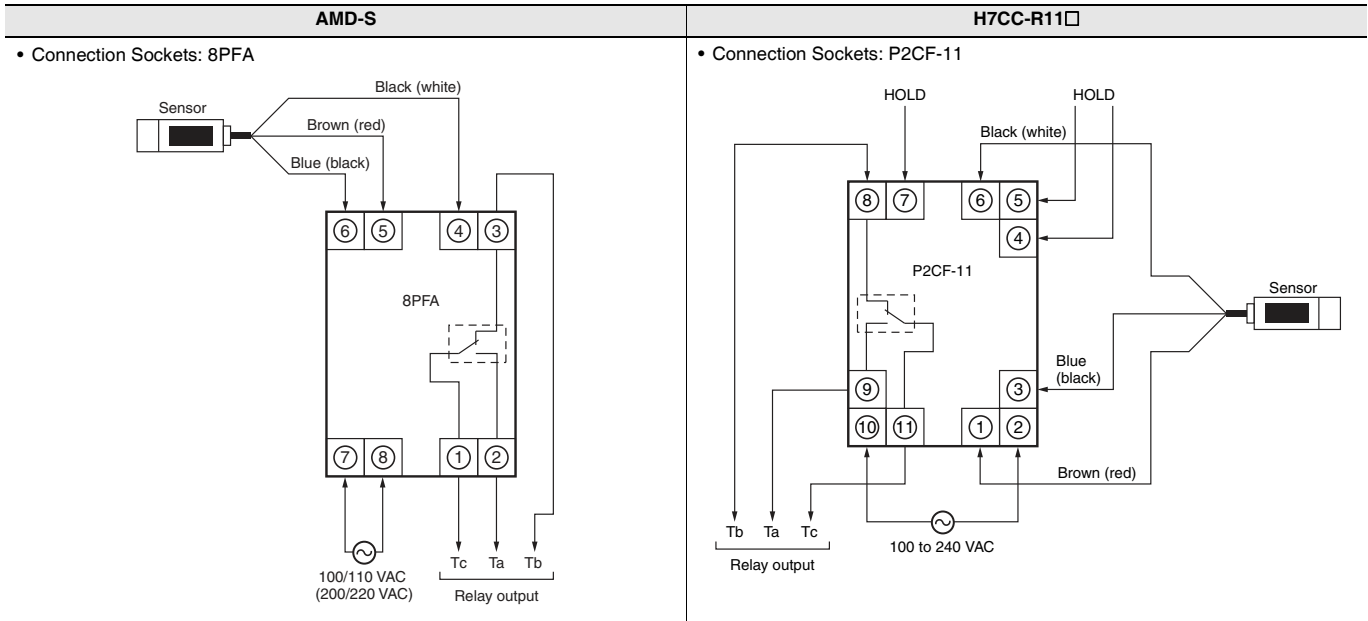

- Note:**
1. Wiring must be changed from an 8-pin socket to an 11-pin socket.
 2. Take into consideration the length of the wires and the terminal numbers.
 3. Order the P2CF-11 Connecting Socket separately.

Setting Procedure

Perform the following settings to achieve the functions of the AMD-S using the H7CC-R11□.

Operation Key Settings

Item	Model	H7CC-R11□		
		Parameters	Setting range	Set value
Measuring ranges	0.01 to 0.1 s (AMD-S□1), 0.1 to 1 s (AMD-S□2), 1 to 10 s (AMD-S□3)	CNTS (CNTS)	---	1ms
				10ms
Output mode	Rotation increase detection (AMD-SU□) Rotation decrease detection (AMD-SL□)	TOTM (TOTM)	---	Lower limit
				Upper limit
Average processing	None	AVGN (AVGN)	---	OFF
Input mode	Voltage Input	IMOD (IMOD)	---	PNP
Startup time	Fixed (0.1 to 10 s)	STMR (STMR)	0.0 ~ 99.9 (0.0s) (99.9s)	0.0

Note: The characters displayed in reverse video are the default settings.

Characteristics

Item	Model	AMD-S	H7CC-R11□
Supply voltage		-100 to 110 VAC -200 to 220 VAC	-100 to 240 VAC
Input method		Voltage input (high: 4 to 14 V, low: 0 to 1 V)	No-voltage input/voltage input (high: 4.5 to 30 V, low: 0 to 2 V)
External power supply		12 VDC ±1 V, 12 mA	12 VDC (±10%), 100 mA
Relay output		5 A at 200 VAC (resistive load)	3 A at 250 VAC/30 VDC (resistive load)
Output mode		Rotation increase (AMD-SU□) Rotation decrease (AMD-SL□)	HI-LO, AREA, HI-HI, LO-LO
Setting method		Input pulse interval (s)	Input pulse interval (s) *
Detection rotation rate range		6 to 6,000 rpm (for 1 pulse/rotation)	0.00006 to 20,000 rpm * (for 1 pulse/rotation)
Startup time		Always from 0.1 to 10 s (Always 10 s if not specified.)	Setting range: 0.0 to 99.9 s
Life expectancy		Output relay electrical operations of 500,000 min.	Output relay electrical operations of 100,000 min.
Memory backup		None	Non-volatile memory (overwrites: 100,000 times min.)

* When set to AMD mode.





Safety Precautions for All H7CC Series (Common)

Be sure to read the precautions for all Counters.

Warning Indications

 CAUTION	Indicates a potentially hazardous situation which, if not avoided, may result in minor or moderate injury or in property damage.
Precautions for Safe Use	Supplementary comments on what to do or avoid doing, to use the product safely.
Precautions for Correct Use	Supplementary comments on what to do or avoid doing, to prevent failure to operate, malfunction or undesirable effect on product performance.

Meaning of Product Safety Symbols

	Caution against electric shock Used to warn of the risk of electric shock under specific conditions.
	General prohibition Indicates the instructions of unspecified prohibited action
	No disassembly Use to indicate prohibition when there is a risk of minor injury from electrical shock or other source if the product is disassembled.
	General instructions Used for general mandatory action precautions for which there is no specified symbol.

CAUTION

Do not allow pieces of metal, wire clippings, or fine metallic shavings or fillings from installation to enter the product. Doing so may occasionally result in electric shock, fire, or malfunction. 

Minor injury due to explosion may occasionally occur. Do not use the Counter where subject to flammable or explosive gas. 

Fire may occasionally occur. Tighten the terminal screws to the rated torque. 

H7CC terminals and
P3GA-11/P3G-08 socket terminals
: 6.55 to 7.97 lb-in (0.74 to 0.90 N·m)
P2CF Socket terminals: 4.4 lb-in (0.5 N·m)

Minor injury due to electric shock may occasionally occur. Do not touch any of the terminals while power is being supplied. Be sure to mount the terminal cover after wiring. 

The service life of the output relay varies considerably according to its usage. Use the output relay within its rated load and electrical life expectancy. If the output relay is used beyond its life expectancy, its contacts may become fused or there may be a risk of fire. Also, be sure that the load current does not exceed the rated load current and when using a heater, be sure to use a thermal switch in the load circuit. 

Minor electric shock, fire, or malfunction may occasionally occur. Do not disassemble, modify, or repair the Counter or touch internal components. 

Precautions for Safe Use

- When mounting the Counter to a panel, tighten the two mounting screws alternately, a little at a time, so as to keep them at an equal tightness. If the panel screws are tightened unequally, water may enter the panel.
- Store the Counter at the specified temperature. If the Counter has been stored at a temperature of less than -10°C , allow the Counter to stand at room temperature for at least 3 hours before use.
- Mounting the Counter side-by-side may reduce the life expectancies of internal components.
- Use the Counter within the specified ranges for the ambient operating temperature and humidity.
- Do not use or store the product in the following locations:
 - Locations subject to sudden or extreme changes in temperature.
 - Locations subject to oil.
 - Locations where high humidity may result in condensation.
 - Locations prone to icing.
 - Locations with excessive vibration or shock.
 - Locations subject to exposure chemicals.
 - Locations subject to water.
 - Locations subject to bugs and small animals
- Do not use this Counter in dusty environments, in locations where corrosive gasses are present, or in locations subject to direct sunlight.
- Install the Counter well away from any sources of static electricity, such as pipes transporting molding materials, powders, or liquids.
- Internal elements may be destroyed if a voltage outside the rated voltage range is applied.
- Be sure that polarity is correct when wiring the terminals.
- Separate the Counter from sources of noise, such as devices with input signals from power lines carrying noise, and wiring for I/O signals.
- Do not connect more than two crimp terminals to the same terminal.
- Up to two wires of the same size and type can be inserted into a single terminals.
- Use the specified wires for wiring.
Applicable Wires: AWG 18 to AWG 22, solid or twisted, copper
(Wire material: Copper)
- Install a switch or circuit breaker that allows the operator to immediately turn OFF the power, and label it to clearly indicate its function.
- When the Counter is operated with no-voltage input (NPN input), approximately 14 V is output from the input terminals. Use a sensor that contains a diode.

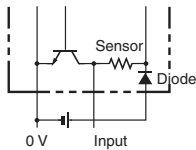

- Use a switch, relay, or other contact so that the rated power supply voltage will be reached within 0.1 seconds. If the power supply voltage is not reached quickly enough, the Counter may malfunction or outputs may be unstable.
- Use a switch, relay, or other contact to turn the power supply OFF instantaneously. Outputs may malfunction and memory errors may occur if the power supply voltage is decreased gradually.
- When changing the set value during operation, because the H7CC uses a constant read-in system, output will turn ON if the set value is equal to the present value.
- When changing the comparison value during operation, because the H7CC uses a constant read-in system, the output status will change if the comparison value is changed to a value on the other side of the present value. (when using as a tachometer)
- If the set value and present value are both 0, the output will turn ON for the default setting. The output will turn OFF during a reset operation. (when using as a counter)
- When the power is turned ON using the factory settings, the output will turn ON after 999.9 s if no pulses are received as count input.

- Do not use organic solvents (such as paint thinners or benzine), strong alkali, or strong acids as they will damage the external finish.
- Confirm that indications are working normally, including the backlight LED, and LCD. The indicator LEDs, LCD, and resin parts may deteriorate more quickly depending on the application environment, preventing normal indications. Periodic inspection and replacement are required.
- The waterproof packing may deteriorate, shrink, or harden depending on the application environment. Periodic inspection and replacement are required.

Precautions for Correct Use

- Read this manual carefully before using the product.
- An inrush current of approx. 10 A will flow for a short time when the power supply is turned ON. If the capacity of the power supply is not sufficient, the Counter may not start. Be sure to use a power supply with sufficient capacity.
- Make sure the power supply voltage and loads are within the specifications and ratings for the product.
- To allow for the startup time of peripheral devices (e.g., sensors) of the Counter (Tachometer), start Counter timing operation 200 ms to 290 ms after turning ON the power. The input signal will not be accepted before 200 to 290 ms has elapsed.

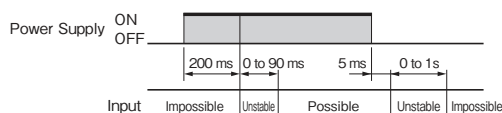

- The input signal will not be accepted after 5 to 1005 ms has elapsed from when the power supply is turned OFF.
- Inrush current generated by turning ON or OFF the power supply may deteriorate contacts on the power supply circuit. Turn ON or OFF to a device with the rated current of more than 10 A.
- The capacity of the external power supply is 100 mA at 12 V. When using a 24 VAC/12 to 48 VDC power supply, reduce the load with the power supply voltage, as shown in the following diagram (DC power supplies only).

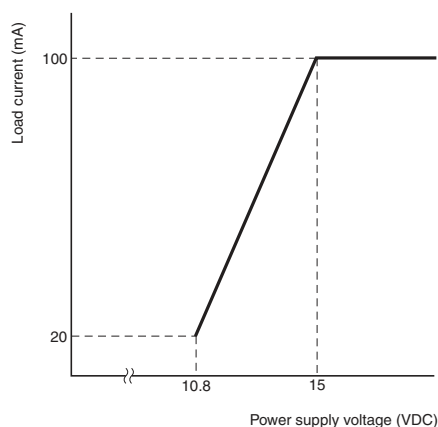

- If the prescale value setting is incorrect, a counting error will occur. Check that the settings are correct before using this function.
- Make sure that all settings are appropriate for the application. Unexpected operation resulting in property damage or accidents may occur if the settings are not appropriate.
- Do not leave the Counter for long periods at a high temperature with output current in the ON state. Doing so may result in the premature deterioration of internal components (e.g., electrolytic capacitors). Do not install the product close contact with the heating element.
- Non-volatile memory is used as backup memory when the power is interrupted. The write life of the non-volatile memory is 100,000 writes. The non-volatile memory is written when the power is turned OFF or when switching from function setting mode or configuration selection mode to run mode.
- Dispose of the product according to local ordinances as they apply.
- Do not use because it may be damaged inside the product when the product fall by mistake.
- Confirm the wiring the input and output terminals correctly before power is supplied.
- Do not use the product near radio wave receivers. Doing so may cause incoming radio wave interference.
- Do not use in a circuit with the waveform is distorted. The error will increase due to the influence of the distorted waveform.
- Install product so that the load doesn't span the product body.

Conformance to EN/IEC Standards

- When conforming to EMC standards, refer to the information provided in this datasheet for cable selection and other conditions.
- This is a class A product. In residential areas it may cause radio interference, in which case the user may be required to take adequate measures to reduce interference.
- Basic insulation is provided between power supply and input terminals, between power supply and output terminals, and between input and output terminals.
- When double insulation or reinforced insulation is required, apply double insulation or reinforced insulation as defined in IEC 60664 that is suitable for the maximum operating voltage with clearances or solid insulation.
- Connect the input and output terminals to devices that do not have any exposed charged parts.

OMRON AUTOMATION AMERICAS HEADQUARTERS • Chicago, IL USA • 847.843.7900 • 800.556.6766 • automation.omron.com

OMRON CANADA, INC. • HEAD OFFICE

Toronto, ON, Canada • 416.286.6465 • 866.986.6766 • automation.omron.com

OMRON ELECTRONICS DE MEXICO • HEAD OFFICE

Ciudad de México • 52.55.5901.4300 • 01.800.386.6766 • mela@omron.com

OMRON ELECTRONICS DE MEXICO • SALES OFFICE

San Pedro Garza García, N.L. • 81.12.53.7392 • 01.800.386.6766 • mela@omron.com

OMRON ELECTRONICS DE MEXICO • SALES OFFICE

Eugenio Garza Sada, León, Gto • 01.800.386.6766 • mela@omron.com

OMRON ELETRÔNICA DO BRASIL LTDA • HEAD OFFICE

São Paulo, SP, Brasil • 55 11 5171-8920 • automation.omron.com

OMRON ARGENTINA • SALES OFFICE

Buenos Aires, Argentina • +54.11.4521.8630 • +54.11.4523.8483
mela@omron.com

OTHER OMRON LATIN AMERICA SALES

+54.11.4521.8630 • +54.11.4523.8483 • mela@omron.com

Authorized Distributor:

Controllers & I/O

- Machine Automation Controllers (MAC) • Motion Controllers
- Programmable Logic Controllers (PLC) • Temperature Controllers • Remote I/O

Robotics

- Industrial Robots • Mobile Robots

Operator Interfaces

- Human Machine Interface (HMI)

Motion & Drives

- Machine Automation Controllers (MAC) • Motion Controllers • Servo Systems
- Frequency Inverters

Vision, Measurement & Identification

- Vision Sensors & Systems • Measurement Sensors • Auto Identification Systems

Sensing

- Photoelectric Sensors • Fiber-Optic Sensors • Proximity Sensors
- Rotary Encoders • Ultrasonic Sensors

Safety

- Safety Light Curtains • Safety Laser Scanners • Programmable Safety Systems
- Safety Mats and Edges • Safety Door Switches • Emergency Stop Devices
- Safety Switches & Operator Controls • Safety Monitoring/Force-guided Relays

Control Components

- Power Supplies • Timers • Counters • Programmable Relays
- Digital Panel Meters • Monitoring Products

Switches & Relays

- Limit Switches • Pushbutton Switches • Electromechanical Relays
- Solid State Relays

Software

- Programming & Configuration • Runtime