

5-100525-6 ✓ ACTIVE

Z-PACK | Z-PACK 2mm HM

TE Internal #: 5-100525-6

Backplane Coding Keys, Plug, Coding Key Number 3456, Z-PACK  
2mm HM

[View on TE.com >](#)



Connectors > PCB Connectors > Backplane Connectors > Backplane Coding Keys

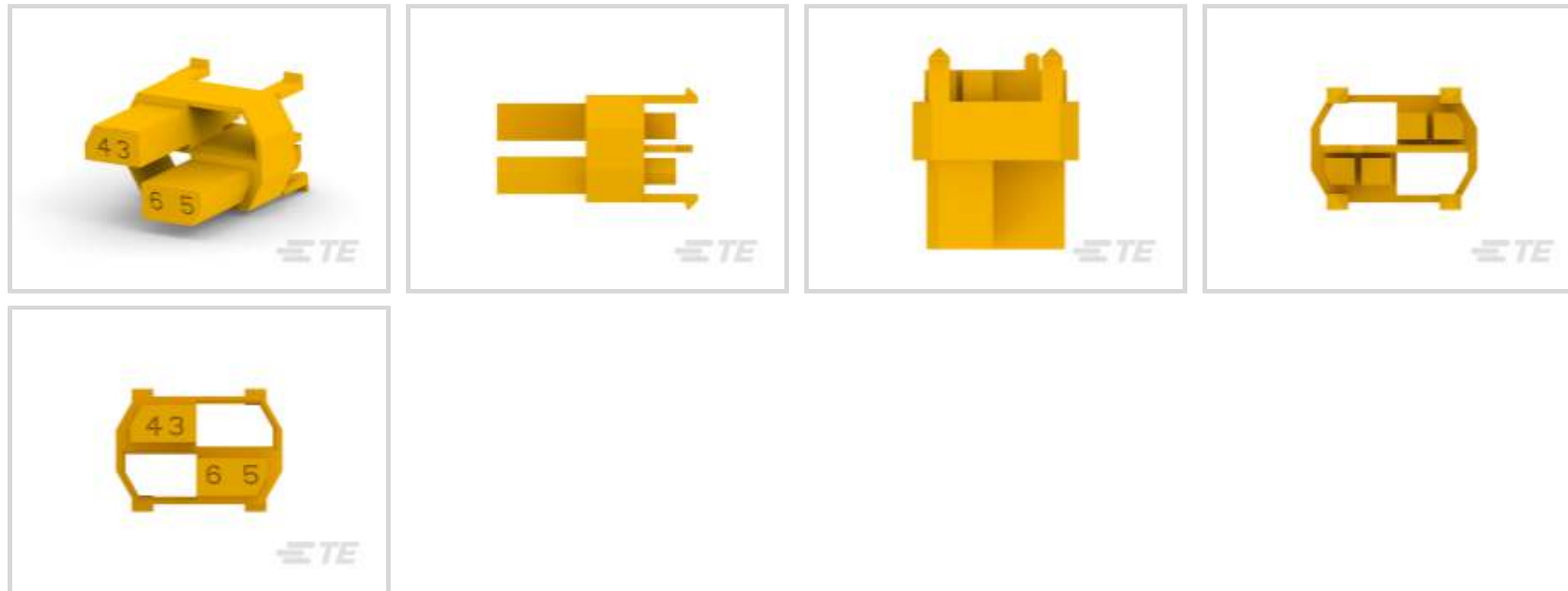

Compatible With Connector Style: **Plug**

Coding Key Number: **3456**

## Features

### Body Features

|                  |                |
|------------------|----------------|
| Coding Key Color | Cadmium Yellow |
|------------------|----------------|

### Usage Conditions

|  |                                |
|--|--------------------------------|
| Compatible With Backplane Connector Type | Type A, Type D, Type L, Type M |
| Compatible With Connector Style          | Plug                           |

### Industry Standards

|                        |           |
|------------------------|-----------|
| CompactPCI Application | CPCI 3.3V |
|------------------------|-----------|

### Packaging Features

|                    |     |
|--------------------|-----|
| Packaging Quantity | 500 |
| Packaging Method   | Bag |

### Other

|                   |      |
|-------------------|------|
| Coding Key Number | 3456 |
|-------------------|------|

## Product Compliance

[For compliance documentation, visit the product page on TE.com>](#)

|                              |           |
|------------------------------|-----------|
| EU RoHS Directive 2011/65/EU | Compliant |
| EU ELV Directive 2000/53/EC  | Compliant |

|   |   |
|---|---|
| China RoHS 2 Directive MIIT Order No 32, 2016 | No Restricted Materials Above Threshold   |
| EU REACH Regulation (EC) No. 1907/2006        | Current ECHA Candidate List: JUNE 2023 (235)<br>Candidate List Declared Against: JUNE 2023 (235)<br>Does not contain REACH SVHC |
| Halogen Content                               | Low Halogen - Br, Cl, F, I < 900 ppm per homogenous material. Also BFR/CFR/PVC Free   |
| Solder Process Capability                     | Not applicable for solder process capability  |

Product Compliance Disclaimer

This information is provided based on reasonable inquiry of our suppliers and represents our current actual knowledge based on the information they provided. This information is subject to change. The part numbers that TE has identified as EU RoHS compliant have a maximum concentration of 0.1% by weight in homogenous materials for lead, hexavalent chromium, mercury, PBB, PBDE, DBP, BBP, DEHP, DIBP, and 0.01% for cadmium, or qualify for an exemption to these limits as defined in the Annexes of Directive 2011/65/EU (RoHS2). Finished electrical and electronic equipment products will be CE marked as required by Directive 2011/65/EU. Components may not be CE marked. Additionally, the part numbers that TE has identified as EU ELV compliant have a maximum concentration of 0.1% by weight in homogenous materials for lead, hexavalent chromium, and mercury, and 0.01% for cadmium, or qualify for an exemption to these limits as defined in the Annexes of Directive 2000/53/EC (ELV). Regarding the REACH Regulation, the information TE provides on SVHC in articles for this part number is based on the latest European Chemicals Agency (ECHA) 'Guidance on requirements for substances in articles' posted at this URL: <https://echa.europa.eu/guidance-documents/guidance-on-reach>

## Compatible Parts



## Also in the Series | Z-PACK 2mm HM

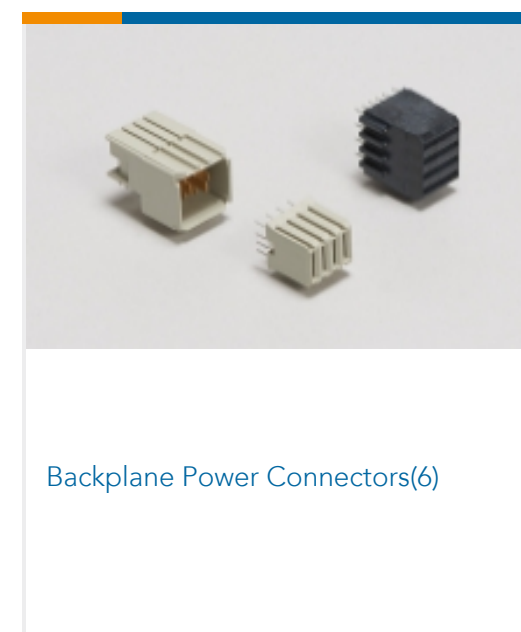
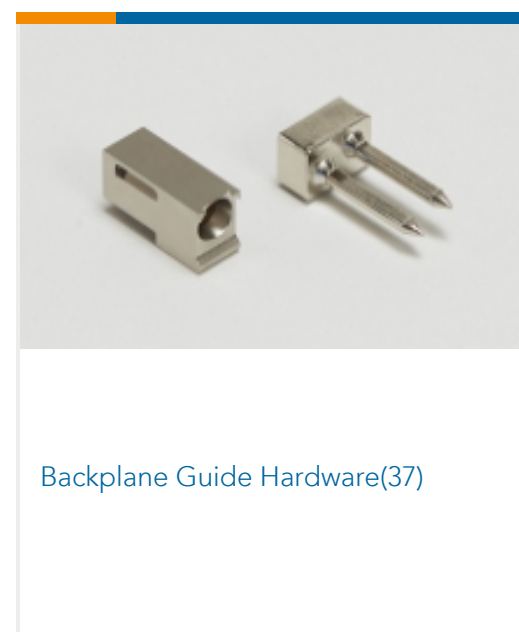
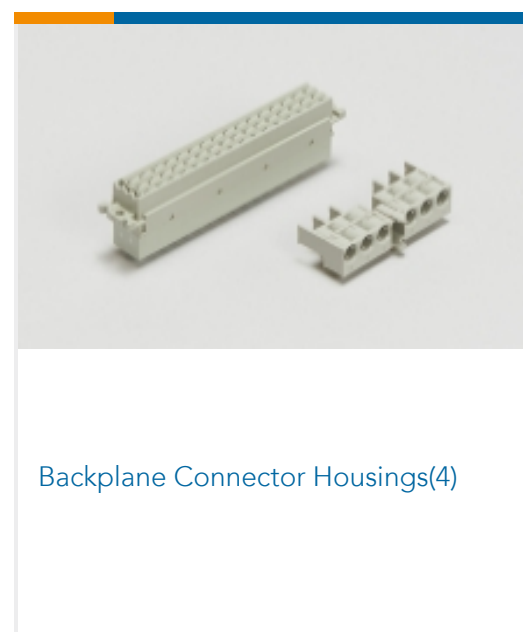
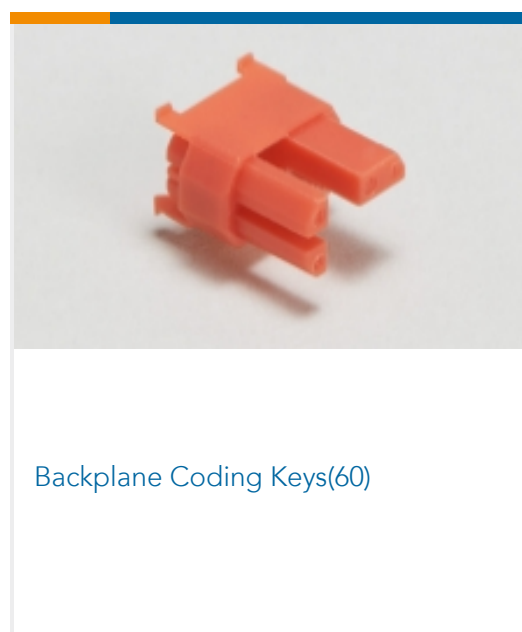



Board-to-Board Connector Contacts(2)

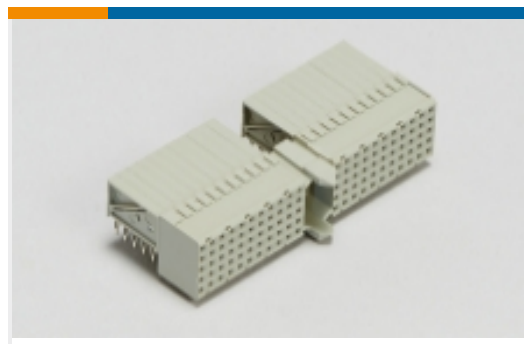

Hard Metric Backplane Connectors (269)

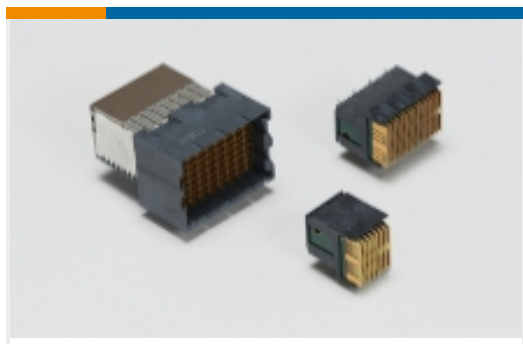

High Speed Backplane Connectors(1)



Insertion & Extraction Tools(2)

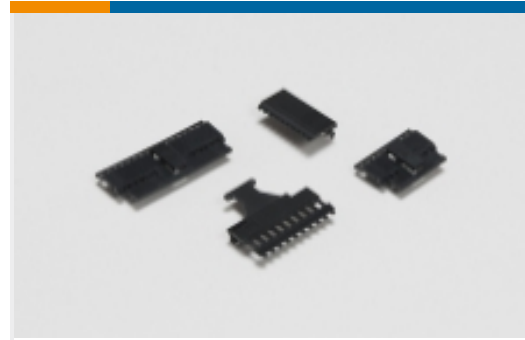

PCB Connector Covers(4)

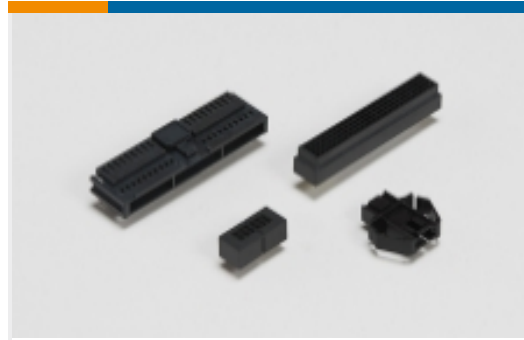

PCB Connector Shrouds(39)



PCB Ferrules & Shields(19)



Rectangular Power Connectors(87)

## Customers Also Bought



TE Part #5100147-1  
Z-PACK/A RAF 110P

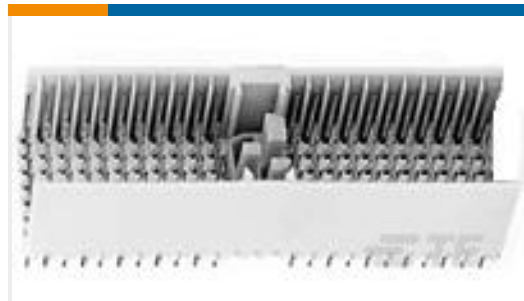

TE Part #5100143-1  
2MM H.M. TYPE "A" PIN ASSY.



TE Part #1648203-1  
297-08-01100=SA CONN,PIN



TE Part #103308-3  
016 LOPRO HDR SP 15DP

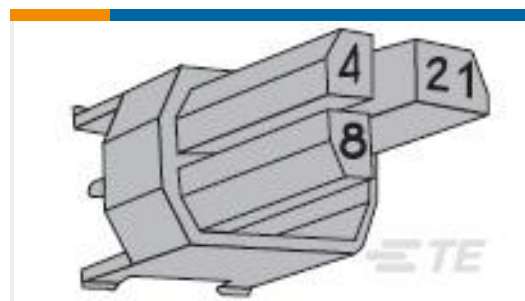

TE Part #5-100525-4  
CODING DEV INSRT COLOR GREEN



TE Part #5-102202-5  
08 MODII HDR SRST SHRD LF

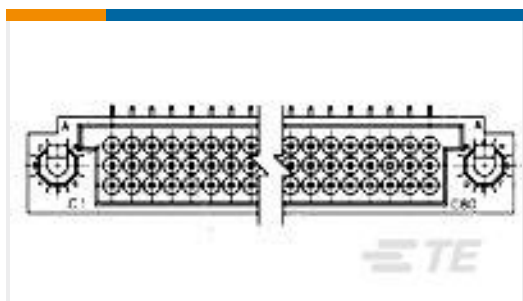

TE Part #446852-8  
3 ROW BOX PIN 240P R/A SEALED



TE Part #A65285-000  
KTT-381127-5-1A

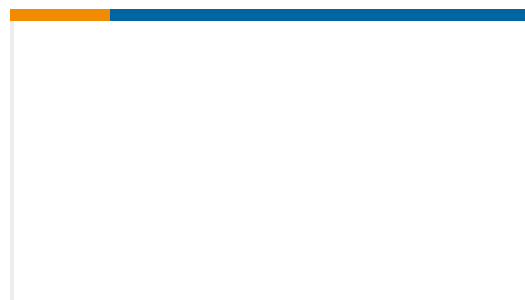

TE Part #2363326-1  
2MM H.M. TYPE "A" PIN ASSY.

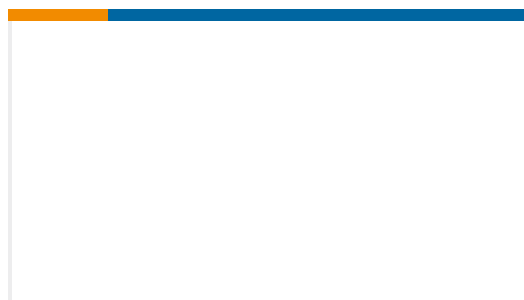

TE Part #353830-7  
040 III HD 72POS CAP ASSY H TIN

## Documents



### Product Drawings

#### Z-PACK M.CODING KEY

English

---

### CAD Files

#### 3D PDF

3D

#### Customer View Model

[ENG\\_CVM\\_CVM\\_5-100525-6\\_C.2d\\_dxf.zip](#)

English

#### Customer View Model

[ENG\\_CVM\\_CVM\\_5-100525-6\\_C.3d\\_igs.zip](#)

English

#### Customer View Model

[ENG\\_CVM\\_CVM\\_5-100525-6\\_C.3d\\_stp.zip](#)

English

By downloading the CAD file I accept and agree to the [Terms and Conditions](#) of use.

---

### Product Specifications

#### Application Specification

English

---

### Product Environmental Compliance

[MD\\_5-100525-6\\_05212018953\\_dmtec](#)

English

[MD\\_5-100525-6\\_05212018953\\_dmtec](#)

English