

C Series

Switch with IEC Connector Compact Size



UL Recognized
CSA Certified
VDE Approved

C Series

Two function power entry module combining a DPST switch and an IEC 320 power line connector. Compact packaging allows a smaller panel cutout with choice of snap-in or flange mounting. Available with general purpose filtering (F models - CFS, CFE), medical application filtering (H models - CHS, CHE) or unfiltered (CS, CE). Terminals allow for easy connection to any wiring scheme. Preconnected terminals from line to switch are available (B Models - CBS, CBE) for reducing OEM wiring time.

The medical versions (H models) are designed specifically for health care applications. Their extremely low leakage current allows compliance with UL544 and UL2601 as well as CSA22.2 health care specifications for use with both patient and non-patient care equipment.

The C series also has the adaptability to fit into existing panel cutouts using snap-on extender options. Using the CA430 extender, the panel cutout height is increased by 0.13". (Extender is available pre-assembled using part numbers with 'K' designation)

Electrical Schematic

F Models (CFS, CFE)



H Models (CHS, CHE)



B Models (CBS, CBE)

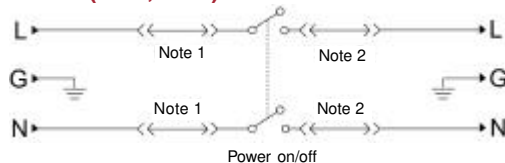

Resistor location for reference only.

Note 1: Jumpers provided on CBS and CBE versions.
Note 2: Location of optional filter.

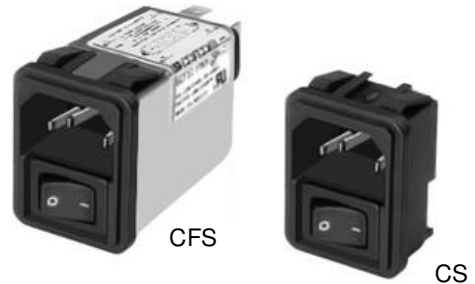

Specifications

Hipot rating (one minute):		
line-to-ground		2250 VDC
line-to-line		1450 VDC
Operating frequency:		50/60 Hz
Rated voltage:		120/250 VAC
Rated current:		10A@120 VAC 10A @250 VAC
Operating voltages:		115/230 VAC
Switch:		Double-insulated rated for 10,000 operations at full load. 51 Amp inrush capability.
Terminals:	Unfiltered	.187" x .032" terminals
	Filtered	.25" x .032" terminals

Filtered Models Only:

Maximum leakage current, each line-to-ground		
F models	@ 120 VAC 60 Hz:	.25mA
	@ 250 VAC 50 Hz:	.40mA
H models	@ 120 VAC 60 Hz:	2µA
	@ 250 VAC 50 Hz:	5µA

Minimum insertion loss in dB: Line-to-ground in 50 ohm circuit

Current Rating	Frequency MHz						
	0.05	0.15	0.5	1	5	10	30

H Models

1A	16	21	37	44	26	21	10
3A	9	14	31	32	26	24	14
6A	4	10	22	23	19	18	13
10A	2	6	10	15	11	11	9

F Models

1A	10	26	46	48	46	47	46
3A	8	16	32	36	43	48	50
6A	4	11	22	27	36	41	50
10A	1	4	14	18	27	33	42

Line-to-line in 50 ohm circuit

Current Rating	Frequency MHz						
	0.05	0.15	0.5	1	5	10	30

H Models

1A	1	6	13	29	38	42	26
3A	1	5	10	22	36	34	36
6A	1	5	14	20	31	33	37
10A	1	4	11	19	32	37	38

F Models

1A	1	3	13	28	62	67	42
3A	2	6	14	23	65	65	67
6A	2	6	14	27	46	48	58
10A	1	7	14	23	42	44	62

Series C

Case Styles

Metric shown in italics.

CS, CBS†

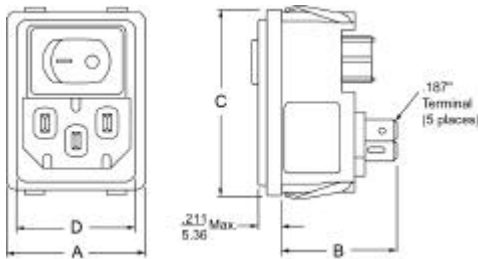

CFS, CHS

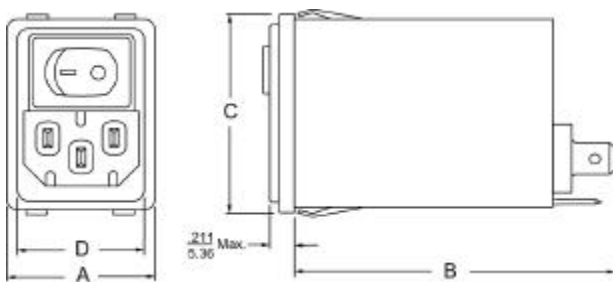

Mounting holes: $\frac{.13}{3.3}$ Dia. (2) with .23 Dia. x 90° Counter sunk

CE, CBE†

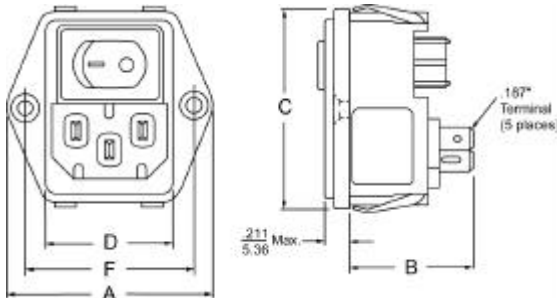

CFE, CHE

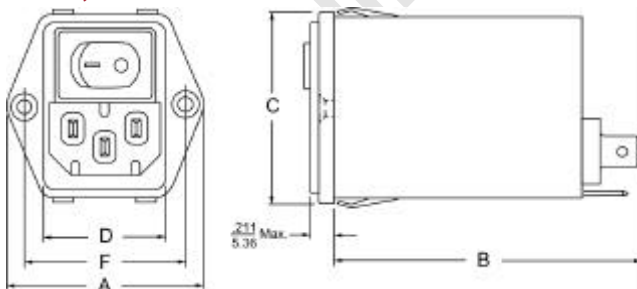

†CBS, CBE Pre-wired Terminals (Side View)

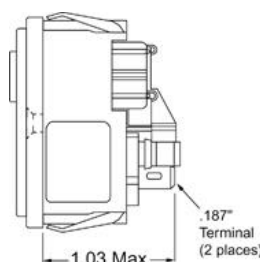

Case Dimensions

Metric shown in italics.

Part No.	A (max)	B (max)	C (max)	D $\pm .006$ $\pm .152$	E $\pm .006$ $\pm .152$	F $\pm .006$ $\pm .152$
CS, CBS	1.23 31.24	.97 24.64	1.62 41.17	1.06 26.92	1.540* 39.12*	
CE, CBE	1.74 44.2	.97 24.64	1.62 41.17	1.06 26.92	1.540* 39.12*	1.417 36.0
CFS, CHS	1.23 31.24	2.53 64.26	1.62 41.17	1.12 28.5	1.540* 39.12*	
CFE, CHE	1.74 44.2	2.53 64.26	1.62 41.17	1.12 28.5	1.540* 39.12*	1.417 36.0

* with K extender (CA430) add to height $\frac{.13}{3.3}$

Panel Cutout

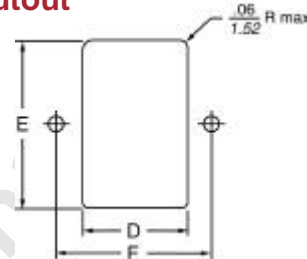

Panel Cutout for thickness of .031-.098 (.8-2.5).
Not recommended for plastic panels.

For snap-in applications, the D sides of the cutout must have a .02 (.508) radius on the installation side.

Snap-in models allow front mounting only.

Ordering Information

Consult your local Corcom sales representative for pricing.

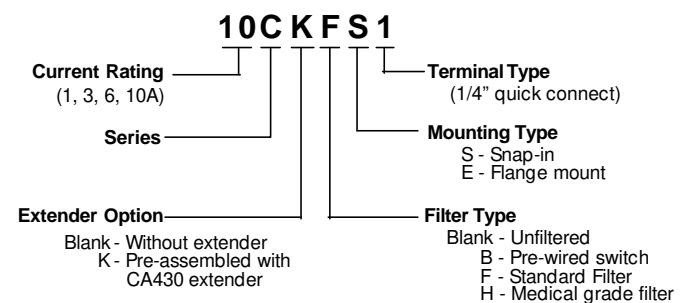

Available Part Numbers

10CS1	10CE1	1CHS1	1CHE1
10CKS1	10CKE1	1CKHS1	1CKHE1
1CFS1	1CFE1	3CHS1	3CHE1
1CKFS1	1CKFE1	3CKHS1	3CKHE1
3CFS1	3CFE1	6CHS1	6CHE1
3CKFS1	3CKFE1	6CKHS1	6CKHE1
6CFS1	6CFE1	10CHS1	10CHE1
6CKFS1	6CKFE1	10CKHS1	10CKHE1
10CFS1	10CFE1		
10CKFS1	10CKFE1		
10CBS1	10CBE1		
10CKBS1	10CKBE1		

CORCOM World Headquarters

844 E. Rockland Road
Libertyville, IL 60048
847.680.7400
www.cor.com