



HERMETIC CONNECTORS

RELIABLE AIR- AND GAS-TIGHT CONNECTIONS

A Wide Range of Connector Families with High Performance Glass-to-Metal Sealing for Harsh Environments and Differential Pressure Applications

Table of Contents



Overview	3
Contact Styles and Sealing Process	5
Hermetic Range Selector Guide	6
Product Configuration Sheet	8
D38999 Connectors Overview	9
D38999 Connector Series I, III, and IV	16
D38999 Connector Series I	16
D38999 Connector Series III	21
D38999 Connector Series IV	27
FDBA Connectors	32
983, EN2997, and ESC10 Connectors	40
MIL-DTL-26482 Connector Series 1	48
MIL-C-26482 Connector Series 2	52
DBA, DBC, and DHS Space Market Connectors	57
MIL-C-83723 - 9602 Connector Series - PAN 6432	65
MIL-C-5015 Connectors	68

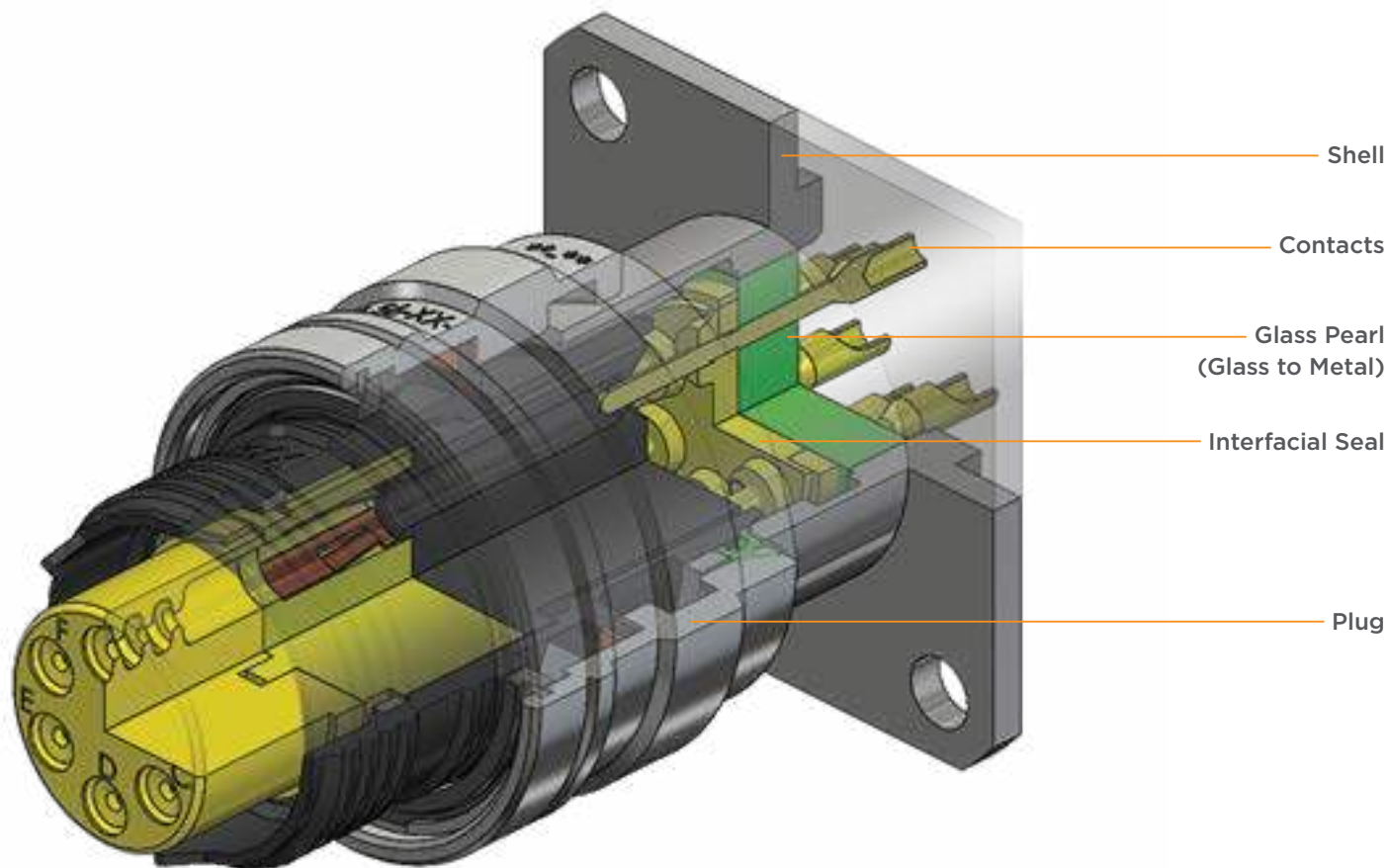

Hermetic Connectors



APPLICATIONS

AEROSPACE

- Actuation
- Air Data Systems
- Bulkhead Feedthrough
- Fuel Utility Systems
- Hydraulic Systems

ENGINES

- FADEC
- Pressure Sensors
- Temperature Sensors
- Torque Sensors

MISSILES AND ORDNANCE

- Optical Systems
- Inertial Guidance
- Electronic Boxes

SEISMIC

- Land Seismic
- Cable Headers
- Hydrostreamers

OFFSHORE

- Ships
- Subsea
- Deep Penetration Applications

Look to DEUTSCH hermetic connectors from TE Connectivity (TE) for reliable, air- and gas-tight connections. For applications ranging from submarines and satellites to aircraft and offshore exploration and production, DEUTSCH hermetic connectors are an excellent choice for harsh application environments. We have four decades of experience in producing glass-to-metal seals for applications where temperature, pressure and environmental considerations render standard connectors unusable.

Hermetic connectors are used to separate an inert atmosphere or vacuum on one side from wide-ranging high-pressure, high-temperature, or corrosive conditions on the other. They are also used to maintain a pressure differential between the two sections. In short, DEUTSCH hermetic connectors are designed to help provide a continuously gas-tight seal while withstanding:

- High pressures
- Extreme temperatures
- High vibration

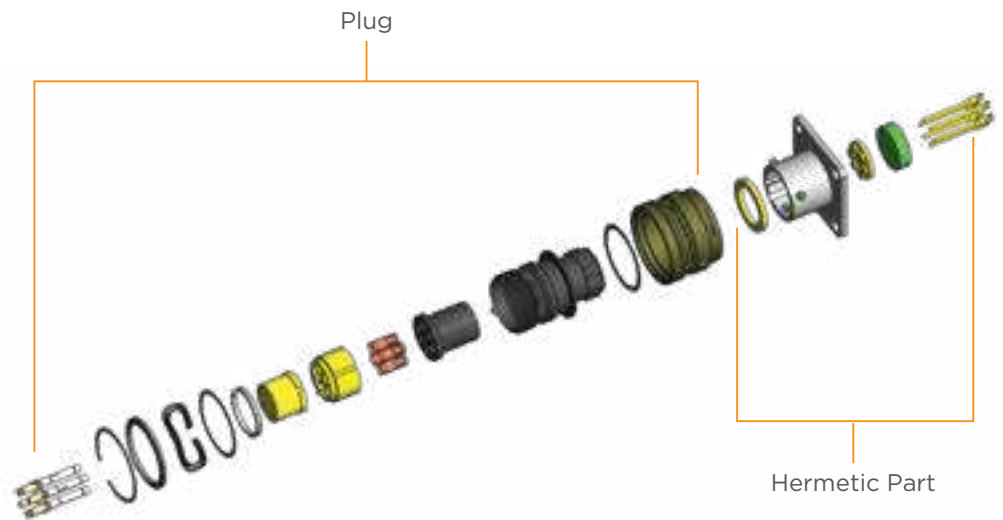

Gas-Tight Glass-to-Metal Sealing

Standard sealing techniques—such as epoxy potting—are useful in many applications, but they do not provide the degree of near-perfect sealing that is offered by glass-to-metal hermetic seals. This is especially true of applications with high-pressure differentials. Glass is a durable, high-strength material that resists extreme changes in temperature or pressure.

Our glass-to-metal seals create a bond between shell, insulator, and contacts by fusing the glass insulator to the metal components. The bond can maintain a helium leak rate $<1 \times 10^{-7}$ He.atm.cm³/s at 14.7 psi. The hermetic bond provides enduring reliability, resists the cracking that would compromise the performance, and withstands a wide range of harsh conditions.

Hermetic Connectors

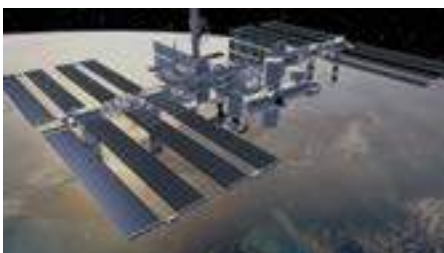

Compression vs. Matched Seals

DEUTSCH hermetic connectors are produced using both compression seals and matched seals.

In a matched seal, the metal and glass have similar coefficients of thermal expansion (CTE). This reduces stress on the glass from thermal expansion and contraction.

In a compression seal, the metal has a higher CTE than the glass. During the firing process to manufacture the connector, the metal expands more than the glass. As the glass and metal then cool, the metal contracts back onto the glass to form an extremely robust bond. Compression seals are used high-pressure applications.

Controlling Quality from Start to Finish

We design and manufacture all the components in our hermetic connectors. We start with high-grade materials—from stainless steel bar stock or exotic metals like titanium for shells, high-grade silica and binders for the glass, and a range of special alloys for contacts, and elastomers carefully matched to the application. An important consideration in material selection is the ability to withstand the high temperatures of the sealing process. All connectors are fully leak tested to ensure the integrity of the hermetic seal.

Materials

Standard materials for hermetic connectors include:

- **Shell: Stainless steel, Aluminum, Kovar®**
- **Insert: Glass**
- **Contacts: Nickel iron (52 Alloy) / Copper**

Other materials are used, depending on application requirements depending on special requirements for:

- **High current**
- **High voltages**
- **High pressures**
- **Extreme temperatures**
- **Severe corrosion conditions**

For example, contacts can be made from nickel iron, Alumel®, Chromel®, and copper-cored nickel iron. More recently, TE has offered weight-saving aluminum-shelled connectors with copper contacts.

Weight-Saving Aluminum Hermetic Connectors

DEUTSCH aluminum hermetic connectors use an aluminum alloy shell to create connectors that are 60% lighter than stainless steel counterparts—two aluminum connectors weigh less than a single stainless steel equivalent.

- **Up to 60% lighter**
- **Higher conductivity: up to 250 A**
- **Lower contact resistance: less than half that of nickel-iron contacts**
- **Wide temperature range: -85°C to +300°C**

Kovar is a registered trademark of Carpenter Technology Corporation. Alumel and Chromel are registered trademarks of Concept Alloys, Inc.

Hermetic Connectors

HIGH SEALING

- Leak rate less than 10^{-7} cm³/s at 1 bar pressure difference under helium
- Less than 1 cm³ leaks in 4 months

SPACE SAVING

- No need of additional rear accessories
- 1/3 shorter than watertight connector equivalent
- Solder mount option for full equipment integration

WIDE RANGE OF STANDARDS

- Large connectors available in circular as well as rectangular ranges: EN2997, MIL-C-26482 Series I and II, EN3646, MIL-C-38999, micro38999, D-Subminiature and more

ADAPTED TO SPECIFIC NEEDS

- Wide range of custom solutions based on standard definition: specific shell, materials, contact length, grounding and more

ENVIRONMENTALLY FRIENDLY

- RoHS: No lead content

A Full Range of Hermetic Choices

DEUTSCH hermetic connectors are available in a variety of military and commercial styles. Options include a choice of:

Pin or socket contacts

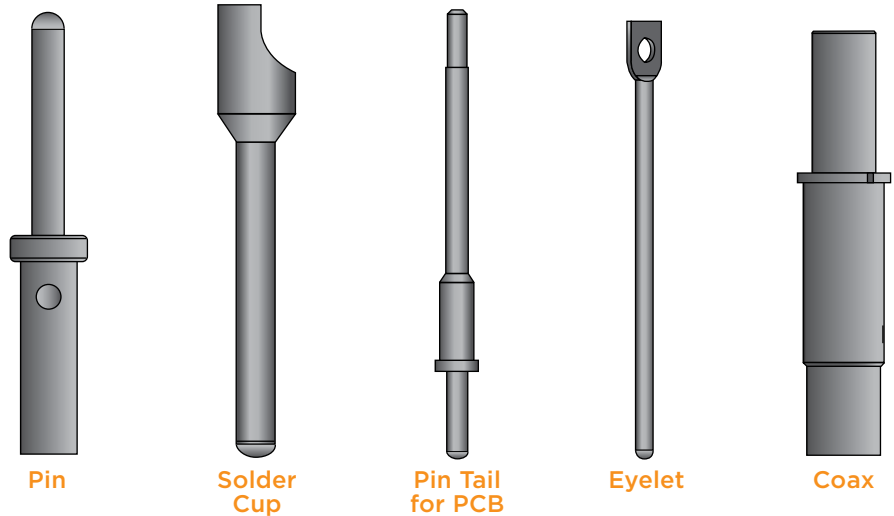

Sealing Process

Compression Sealing

Compression sealing is mainly used for steel and stainless steel for standard applications with power contacts, or signal processing. This type of sealing allows to sustain high pressure and temperature, with a most important expansion of the metal than the glass pearl during the heating and a material contraction during the cooling which allow a robust compression bond.

Match Sealing

Match sealing is used for the specific applications, where we need perfect control of the sealing phase to meet strict requirements. The materials used are mainly alloys with controlled expansion.

Low Temperature Sealing

Low temperature sealing is used for all complex shell material, aluminum, which allow to save weight retaining all the qualities of sealing by compression and compliance with severe environmental requirements.

Hermetic Connectors

Hermetic Range Selector Guide

MIL-DTL-38999 Series I

Page 16

DEUTSCH DJT Series



EN3646

Page 32

DEUTSCH FDBA Series



MIL-DTL-38999 Series III

Page 21

DEUTSCH DTS Series



EN2997 / ESC10

Page 40

DEUTSCH 983 Series



MIL-DTL-38999 Series IV

Page 27

DEUTSCH DIV Series



MIL-DTL-26482 Series I

Page 48

DEUTSCH DTK, 22628 Series



Hermetic Connectors

Hermetic Range Selector Guide

MIL-C-26482 Series 2

Page 52

DEUTSCH DBA50, DBC50 Series



MIL-C-83723 Series 9602

Page 65

Series 9602



MIL-DTL-83723 Series III Threaded

Page 57

DEUTSCH DBA30, DBC30 Series



MIL-DTL-5015

Page 68

DEUTSCH DF02, DH02 Series



Hermetic Connectors

Hermetic Connector Product Configuration Sheet

MIL Spec Number

Customer Part Number

TE Part Number / Description

Application

Platform

Please complete one form per connector. Mark your selection with a ✓

MECHANICAL REQUIREMENTS

Connector Type

- Square Flange Receptacle
- Solder Flange Receptacle
- Jam-Nut Receptacle
- Bulkhead
- Feedthrough
- Custom

Locking Type

- Screw
- Bayonet
- Push-Pull

Shell Material

- Steel
- Stainless Steel
- Aluminum
- Marine Bronze
- Inconel (Kovar Contacts)
- Other

Contact Types

- Pin
- Solder Cup
- Pin Tail for PCB
- Eyelet
- Coax

Contacts Termination Finish

- Gold Plated (23K)
- Gold Plated (24K)
- Tin

Shell Surface Finish

- Electroless Nickel
- Polished (Stainless Steel only)
- Gold Plated
- Tin Plated
- Silver Plated

ENVIRONMENTAL REQUIREMENTS

Operating Temperatures

- 55°C to +150°C
- 55°C to +175°C
- 55°C to +200°C
- 55°C to +260°C
- Other

Corrosion as per EN 2591-307

- No Need
- 48h
- 96h
- Highest

Air Leakage (Under 1 Bar Vacuum.)

- ≤ 1.10 - 6 mbar.l/s
- ≤ 1.10 - 7 mbar.l/s
- Highest

Pressure Resistance

- 1 - 50 Bars
- 50 - 100 Bars
- > 100 Bars
- Highest

Pressure Delta (Type of Stress)

- Air
- Helium
- Gas (Argon, etc. . .)
- Water
- Others

ELECTRICAL REQUIREMENTS

Service Voltage

- 500 V eff. 50 Hz
- Other

Insulation Resistance

- ≥ To 5000 MΩ to 25°C and 60% HR
- Other

Contacts Maximum Current

- 5 A Max.
- 10 A Max.
- 15 A Max.
- 20 A Max.
- ≥ 20 A Max.

Contact Resistance

- > 20 mΩ under Max Intensity
- > 10 mΩ under Max Intensity
- > 5 mΩ under Max Intensity
- > 1 mΩ under Max Intensity

Fill in the attached sheet and send directly to your TE sales administration contact, field engineer OR submit form directly to Matthias Puissant at matthias.puissant@te.com

Hermetic Connectors

EXTREME TEMPERATURE

- -65°C to +200°C

AIRTIGHT/VACUUM

- $<1 \times 10^{-7}$ cm³/s @ 14.7 psi

ENVIRONMENTAL CONDITIONS

- Fluid Resistance
- Corrosion Resistance
- High Vibration

APPLICATIONS

- Sensors
- Fuel Tank Systems
- Down-Hole Drilling Equipment
- Electronic Equipment
- Engine Accessories
- Pyrotechnic Equipment
- Vacuum Chambers
- Optical Devices
- Missiles
- Avionics
- Sealed Environments

MIL-DTL-38999 Spec Hermetic Connectors

TE Connectivity (TE) has more than 28,000 standard configurations from hermetic termination styles including solder cups, eyelets, PC tails, and weld clips to crimp termination. Our extensive offering of MIL-DTL-38999 standard hermetic connectors in series I, II and IV provide a high degree of performance in demanding and extreme applications where even the most resilient connectors can fail.

Product Features

- Modified Flanges
- Any Termination Style
- Special Materials (Such as Titanium)
- High-Temperature and Cryogenic Materials
- Ability to Withstand High Pressure

Vertical Markets

AEROSPACE

- Actuation
- Air Data Systems
- Bulkhead Feedthrough
- Fuel Utility Systems
- Hydraulic Systems

ENGINES

- Pressure Sensors
- Temperature Sensors
- Torque Sensors
- FADEC

MISSILES AND ORDNANCE

- Optical Systems
- Inertial Guidance
- Electronic Boxes

SEISMIC

- Land Seismic
- Cable Headers
- Hydrostreamers

OFFSHORE

- Ships
- Subsea
- Deep Penetration Applications

Connector Styles

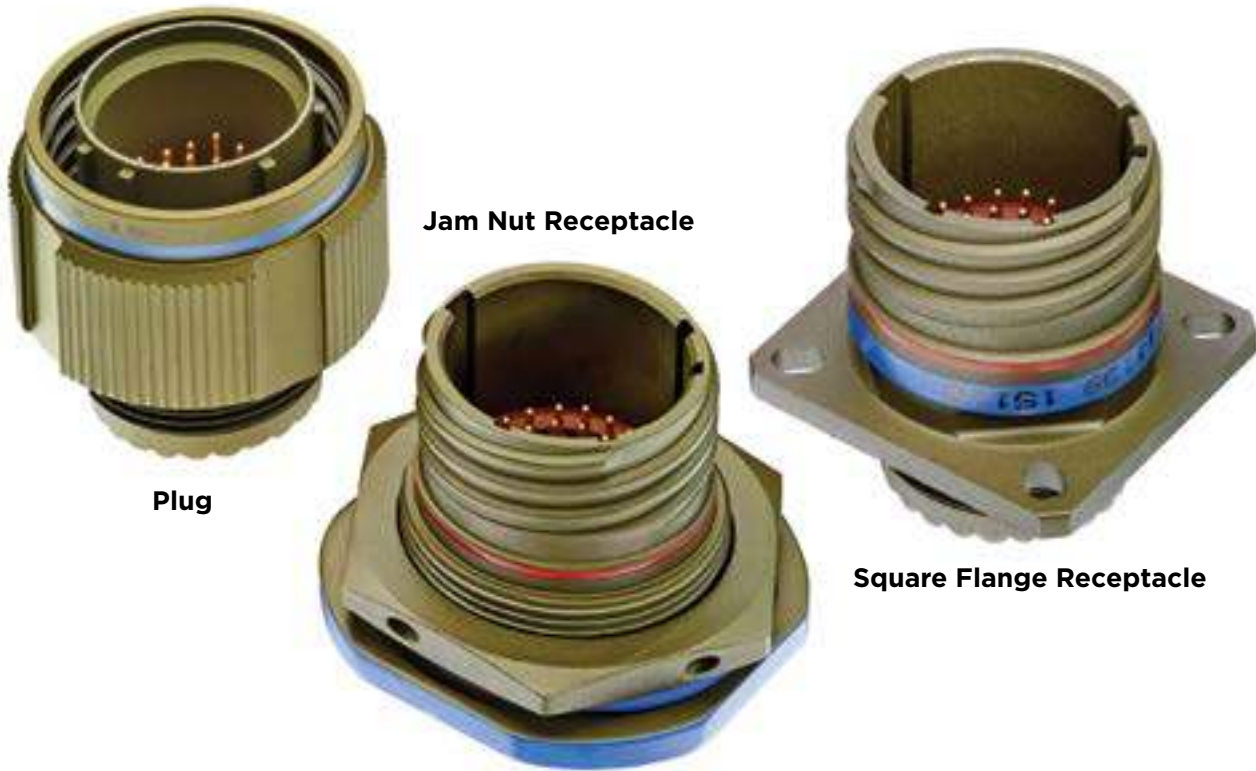

Plug

Plugs are free-hanging cable-mount halves of a connection. They contain the coupling ring used to secure the plug to the receptacle.

Jam Nut Receptacle

Jam nuts are the preferred style for creating an environmentally sealed mounting. Single-hole mounting and an integral o-ring allows a sealed mounting with a single hex nut threaded onto the front of the connector to secure it in place. Jam nut receptacles are rear-mount connectors.

Square Flange Receptacle

These standard receptacles have a relatively large four-hole flange for front or rear mounting to a bulkhead or panel.

Shell Materials

TE 38999 connectors are available with aluminum and stainless steel. In addition, we offer 38999-style connectors in marine bronze.

<p>Aluminum</p>	<p>Aluminum offers a favorable balance of performance, weight, and cost Most widely used material Light weight Excellent corrosion resistance Available in all finishes Rugged</p>
<p>Stainless Steel</p>	<p>Stainless steel is used for hermetic connectors or for connectors used in high-temperature environments, including engines and firewalls Passivated or nickel finish</p>
<p>Marine Bronze</p>	<p>With excellent corrosion resistance, aluminum nickel bronze is popular for marine applications Unplated marine bronze helps eliminate the danger of wear to plating that could expose the underlying material to corrosion. See the section on DEUTSCH DTS-B series connectors.</p>

Arrangements

Male Insert: Front Face View

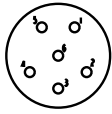

09-06
7 Size 22M
Contacts

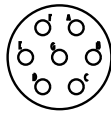

09-07
7 Size 22D
Contacts

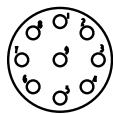

09-23
9 Size 23
Contacts

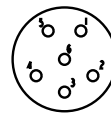

09-35
6 Size 22D
Contacts

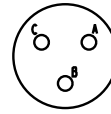

09-98
3 Size 20
Contacts

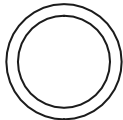

11-01
1 Size 8
Contact

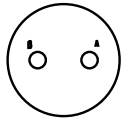

11-02
2 Size 16
Contacts

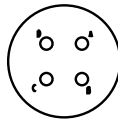

11-04
4 Size 20
Contacts

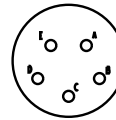

11-05
5 Size 20
Contacts

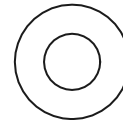

11-12
1 Size 12
Contact

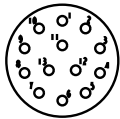

11-13
13 Size 22M
Contacts

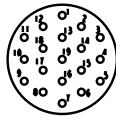

11-23
19 Size 23
Contacts

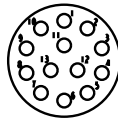

11-35
13 Size 22D
Contacts

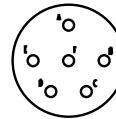

11-98
6 Size 20
Contacts

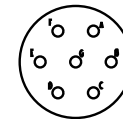

11-99
7 Size 20
Contacts

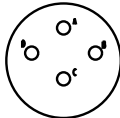

13-04
4 Size 16
Contacts

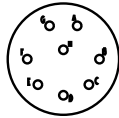

13-08
8 Size 20
Contacts

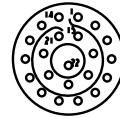

13-22*
22 Size 22M
Contacts

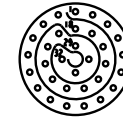

13-23
32 Size 23
Contacts

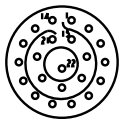

13-35
22 Size 22D
Contacts

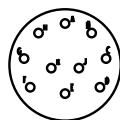

13-98
10 Size 20
Contacts

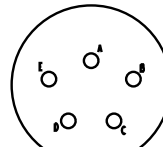

15-05
5 Size 16
Contacts

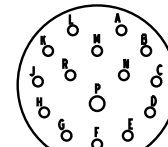

15-15
14 Size 20
Contacts

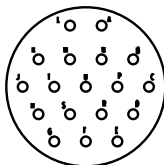

15-18
18 Size 20
Contacts

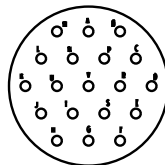

15-19
19 Size 20
Contacts

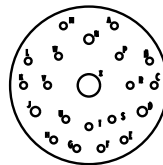

15-21
1 Size 12 Coax Contact
3 Size 20 Contacts
17 Size 22D Contacts

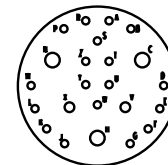

15-A23
4 Size 16 Coax Contacts
3 Size 20 Contacts
19 Size 22D Contacts

Arrangements



15-23
55 Size 23 Contacts

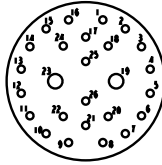

15-26
2 Size 16 Contacts
24 Size 22D Contacts

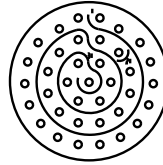

15-35
37 Size 22D Contacts

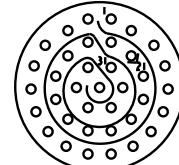

15-37
37 Size 22M Contacts

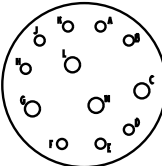

15-97
4 Size 12 Contacts
8 Size 20 Contacts

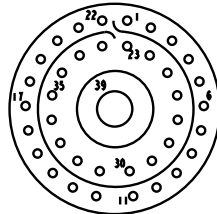

17-02*
1 Size 8 Twinax Contact
38 Size 22D Contacts

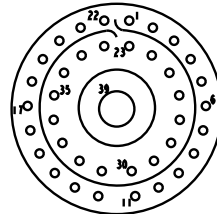

17-03
1 Size 8 Twinax Contact
38 Size 22D Contacts

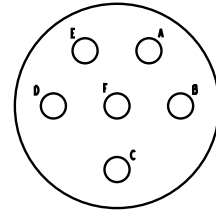

17-06
6 Size 12 Contacts

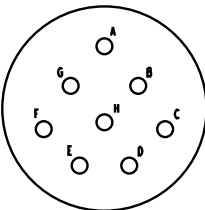

17-08
8 Size 16 Contacts

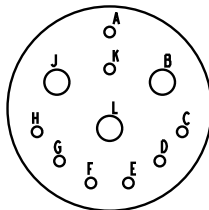

17-11
2 Size 12 Twinax Contacts
1 Size 12 Coax Contact
8 Size 20 Contacts

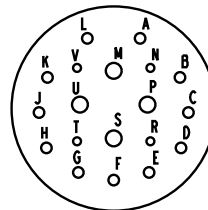

17-19
4 Size 16 Contacts
11 Size 20 Contacts
4 Size 22D Contacts

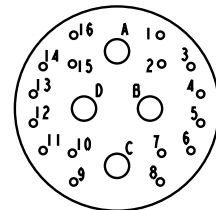

17-20
4 Size 12 Contacts
16 Size 22D Contacts

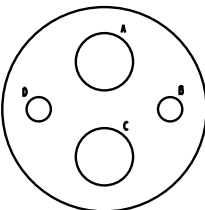

17-22
2 Size 8 Twinax Contacts
2 Size 10 Contacts

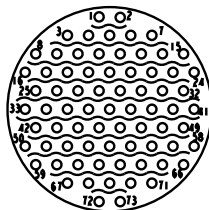

17-23
73 Size 23 Contacts

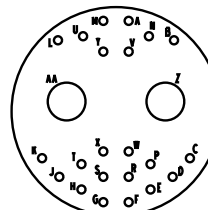

17-24
2 Size 8 Power Contacts
2 Size 12 Contacts

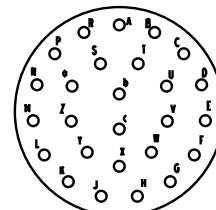

17-26
26 Size 20 Contacts

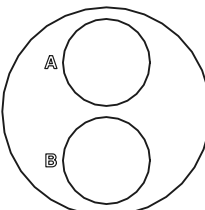

17-28
2 Size 8 Twinax Contacts

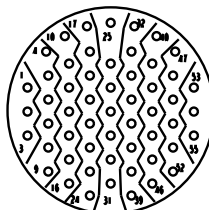

17-35
55 Size 22D Contacts

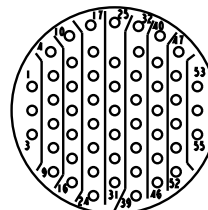

17-55
55 Size 22M Contacts

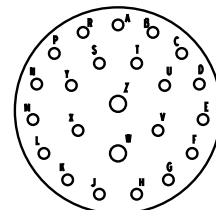

17-99
2 Size 16 Contacts
21 Size 20 Contacts

Arrangements

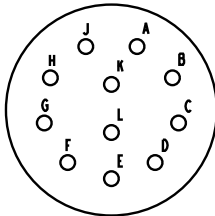

19-11
11 Size 16 Contacts

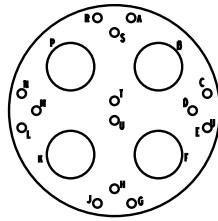

19-18*
4 Size 8 Twinax Contacts
14 Size 20 Contacts

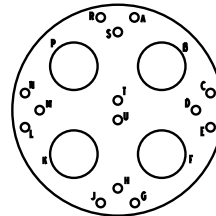

19-19
4 Size 8 Twinax Contacts
14 Size 20 Contacts

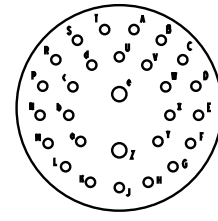

19-28
2 Size 16 Contacts
26 Size 20 Contacts

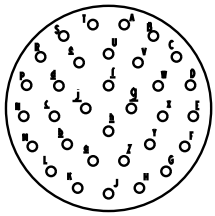

19-32
32 Size 20 Contacts

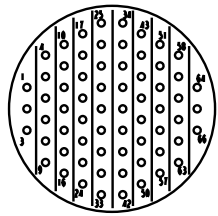

19-35
66 Size 22D Contacts

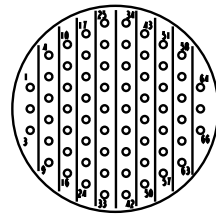

19-66*
66 Size 22M Contacts

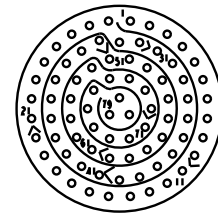

21-01*
79 Size 22M Contacts

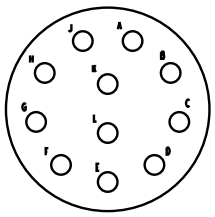

21-11
11 Size 12 Contacts

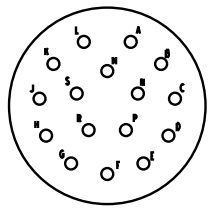

21-16
16 Size 16 Contacts

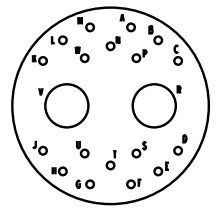

21-20
2 Size 8 Twinax Contacts
18 Size 20 Contacts

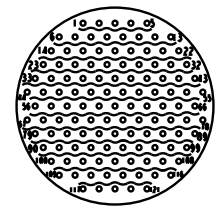

21-23
121 Size 23 Contacts

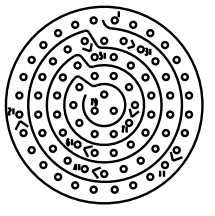

21-35
79 Size 22D Contacts

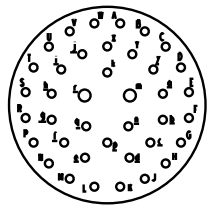

21-39
2 Size 16 Contacts
37 Size 20 Contacts

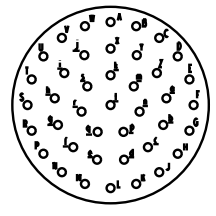

21-41
41 Size 20 Contacts

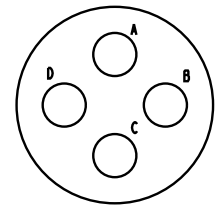

21-48
4 Size 8 Power Contacts

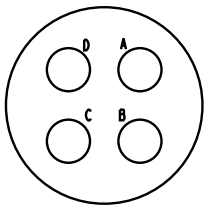

21-75*
4 Size 8 Twinax Contacts

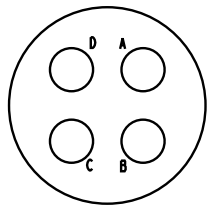

21-76
4 Size 8 Twinax Contacts

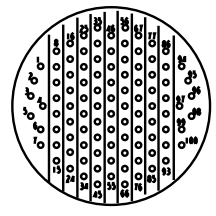

23-01*
100 Size 22M Contacts

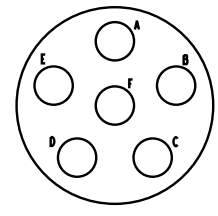

23-06
6 Size 8 Twinax Contacts

Arrangements

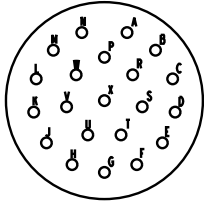

23-21
21 Size 16 Contacts

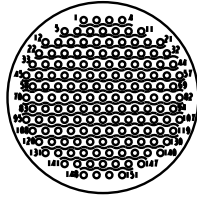

23-23
151 Size 23 Contacts

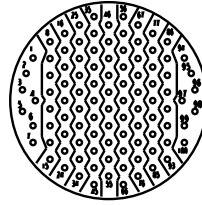

23-35
100 Size 22D Contacts

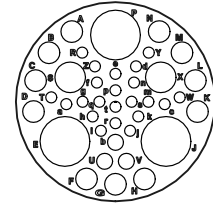

23-41
3 Size 8 Contacts
3 Size 12 Contacts
11 Size 16 Contacts
3 Size 20 Contacts
22 Size 22D Contacts

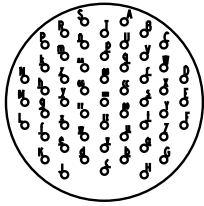

23-53
53 Size 20 Contacts

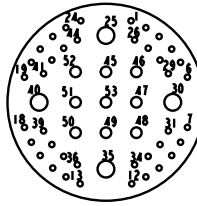

23-54
4 Size 12 Contacts
9 Size 16 Contacts
40 Size 22D Contacts

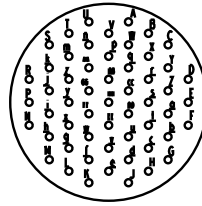

23-55
55 Size 20 Contacts

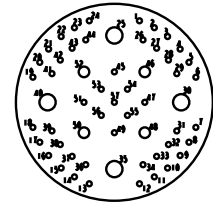

23-63
4 Size 12 Contacts
4 Size 16 Contacts
49 Size 22D Contacts

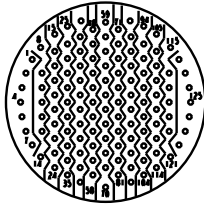

25-01*
128 Size 22D Contacts

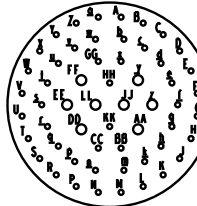

25-04
8 Size 16 Contacts
48 Size 20 Contacts

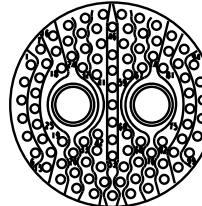

25-07*
2 Size 8 Twinax Contacts
97 Size 22D Contacts

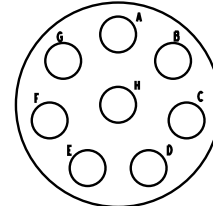

25-08*
8 Size 8 Twinax Contacts

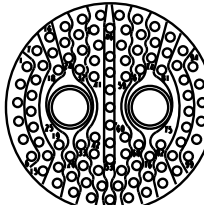

25-09
2 Size 8 Twinax Contacts
97 Size 22D Contacts

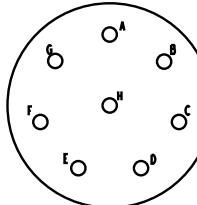

25-10
8 Size 8 Twinax Contacts

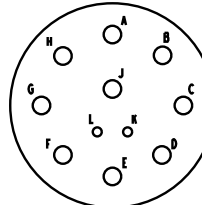

25-11
9 Size 10 Contacts
2 Size 20 Contacts

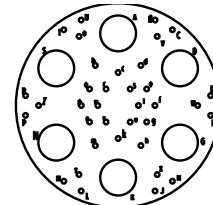

25-17
6 Size 8 Twinax Contacts
36 Size 22D Contacts

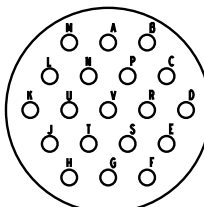

25-19
19 Size 12 Contacts

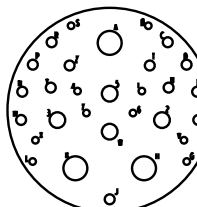

25-20
3 Size 8 Twinax Contacts
4 Size 12 Coax Contacts
13 Size 16 Contacts
10 Size 20 Contacts

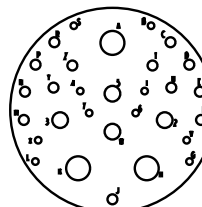

25-21
3 Size 8 Twinax Contacts
4 Size 12 Coax Contacts
13 Size 16 Contacts
10 Size 20 Contacts

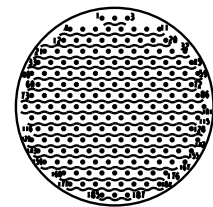

25-23
187 Size 22D Contacts

Arrangements

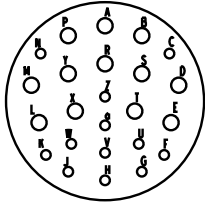

25-24
12 Size 12 Contacts
12 Size 16 Contacts

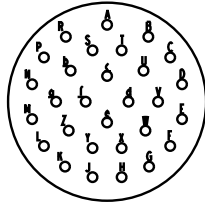

25-29
29 Size 16 Contacts

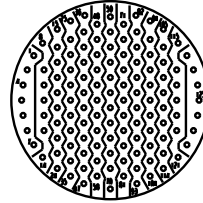

25-35
128 Size 22D Contacts

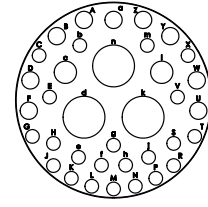

25-36
3 Size 8 Contacts
1 Size 12 Coax Contact
1 Size 12 Contact
10 Size 16 Contacts
24 Size 20 Contacts

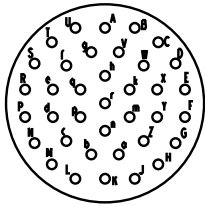

25-37
37 Size 16 Contacts

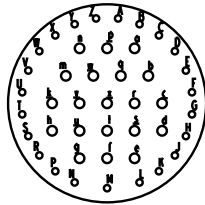

25-43
20 Size 16 Contacts
23 Size 20 Contacts

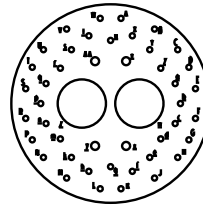

25-46*
2 Size 8 Coax Contacts
4 Size 12 Contacts
40 Size 20 Contacts

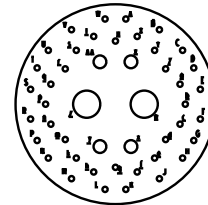

25-47
2 Size 8 Coax Contacts
4 Size 12 Contacts
40 Size 20 Contacts

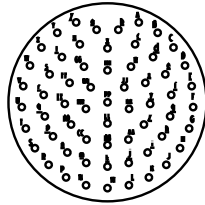

25-61
61 Size 20 Contacts

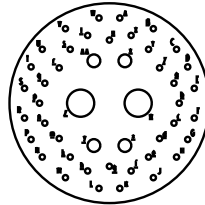

25-90*
2 Size 8 Twinax Contacts
4 Size 16 Contacts
40 Size 20 Contacts

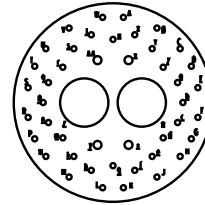

25-91
2 Size 8 Twinax Contacts
4 Size 16 Contacts
40 Size 20 Contacts

MIL-DTL-38999 Series I



DEUTSCH DJT Series Connectors

The DEUTSCH DJT Series connectors from TE Connectivity (TE) are high-performance MIL-DTL-38999 Series I subminiature circular connectors offering a scoop-proof design for easy, reliable mating.

Available in 9 shell sizes and hermetic versions, DEUTSCH DJT Series connectors feature a self-locking bayonet coupling system. They are completely intermateable and interchangeable with MIL-DTL-38999 Series I connectors, and are available in a variety of shell materials and finishes.

Designed for rugged reliability, DEUTSCH DJT Series connectors are highly durable, capable of 500 mating cycles. They provide excellent vibration, corrosion and shock resistance.

RUGGED

- Self-locking bayonet coupling system
- 500-mating-cycle durability
- Excellent shock and vibration resistance
- Environmentally sealed and hermetic versions available

VERSATILE

- Available in 9 shell sizes
- Intermateable and interchangeable with all other MIL-DTL-38999 Series I connectors
- Available in a variety of shell materials and finishes
- Wide range of backshells and accessories

EMI PROTECTED

- Grounding fingers for excellent EMI protection
- Connector is grounded when the shells meet, even before the contacts are engaged
- Metal-to-metal bottoming to help maximize EMI grounding protection
- EMI shielding effective up to 10 GHz

MATERIALS

- **Shell Material and Plating:** Aluminum, electroless nickel / electrodeposited nickel / stainless steel, passivated
- **Insert:** Thermoplastic and fluorinated silicone elastomer
- **O-Ring:** Fluorinated silicone elastomer
- **Hermetic Seal:** Sintered glass

ENVIRONMENTAL

- **Temperature Range:** -65°C to +200°C – Nickel finish (Class F) and stainless steel (Class E)
- **Fluid Resistance:** Fluid immersion per EIA 364.10, including resistance to MIL-PRF-5606: Hydraulic fluid / MIL-DTL-83133: JP-8 aviation fuel / MIL-PRF-7808: Lubricating oil / MIL-PRF-23699: Lubricating oil / MIL-A-8243: Deicing/defrosting fluid / MIL-C-25769: Aircraft cleaning compound / MIL-PRF-87937: Aircraft cleaning compound / MIL-G-3056: Gasoline
- **Salt Spray:** 48 or 96 hours (Nickel and passivated finishes)
- **Thermal Cycling:** -65° to 150/175/200°C (max. temperature is class dependent)

MECHANICAL

- **Sine Vibration:** Up to 60 g for 36 hr.
- **Random Vibration:** Up to 41.7 g for 16 hr. at 175°C / Up to 50 g for 16 hr. at ambient temperature
- **Shock:** 300 g, 3 ms in the 3 axes
- **Durability:** 500 mating cycles

MIL-DTL-38999 Series I

• Contact Retention:

Size 22D: 44 N (10 lb.) / Size 20: 67 N (15 lb.) / Size 16: 111 N (25 lb.)
 Size 12: 111 N (25 lb.) / Size 10: 111 N (25 lb.) / Size 8: 111 N (25 lb.)

ELECTRICAL

- **Shell-to-Shell Conductivity:** 1.0 mV (nickel finish)
 2.5 mV (cadmium finish)
 10.0 mV (passivated finish)
- **Shielding Effectiveness:** >90 dB at 100 MHz, >65 dB through 10 GHz
- **Leakage:** 1.10^{-6} mbar.l.s-1 under 1 bar vacuum or 0.36 mm³/h (as per the EN2591-322)
- **Thermal Shock:** 10 cycles, 4°C max. to 90°C min.

Voltage Rating

Service Rating	Suggested Operating Voltage		Test Voltage at Altitude (VAC _{rms})			
	VAC _{rms}	VDC	Sea Level	50,000 Ft.	70,000 Ft.	100,000 Ft.
M	400	550	1300	550	350	200
N	300	450	1000	400	260	200
I	600	850	1800	600	400	200
II	750	1050	2300	800	500	200

Current Rating

Contact Size	Test Current (A)	Voltage Drop (mV)
22D	5	73
20	7.5	55
16	13	50
12	23	42
10	33	34
8*	46	26

*When commercial power contact replaces twin-ax contact

Thread Sizes

Shell Size	Accessory Thread (Class 2A)	Jam Nut Thread (Class 2A)
9	.4375-28 UNEF	.6875-24 UNEF
11	.5625-24 UNEF	.8125-20 UNEF
13	.6875-24 UNEF	1.0000-20 UNEF
15	.8125-20 UNEF	1.1250-18 UNEF
17	.9375-20 UNEF	1.2500-18 UNEF
19	1.0625-18 UNEF	1.3750-18 UNEF
21	1.1875-18 UNEF	1.5000-18 UNEF
23	1.3125-18 UNEF	1.6250-18 UNEF
25	1.4375-18 UNEF	1.7500-18 UNS

DEUTSCH Base Part No.	Mil Cross Type	Receptacle Mounting	Variations		
			Mil Classes	Mil Finishes	Contact Styles
Series I: Scoop-Proof Bayonet Coupling					
DJT10H	MS27469	Square Flange	H Space Grade Y Electropolished Stainless Steel	E Passivated Stainless Steel	P Pin, Solder Cup X Pin, Eyelet C Pin, PCB Flex Feedthrough
DJT14H	MS27470	Jam Nut			
DJT11H	MS27471	Solder Mount			

Keying Options

(Viewed from Mating Face of the Receptacle Connector)

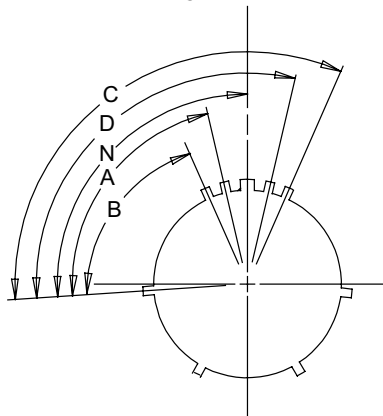

Shell Size	Key Position (Degrees)				
	N	A	B	C	D
09	95	77	—	—	113
11	95	81	67	123	109
13	95	75	63	127	115
15	95	74	61	129	116
17	95	77	65	125	113
19	95	77	65	125	113
21	95	77	65	125	113
23	95	80	69	121	110
25	95	80	69	121	110

Degrees in table above are the distance between Datum E (that bisects first minor keyway) and the center line of the master keyway

MIL-DTL-38999 Series I

Series I

Series III

Series IV

Military Part Numbering System

MS27471 Y 25 F 35 S D xxxx

MIL SPEC NUMBER/SHELL STYLE

- MS27470** Jam Nut Hermetic Receptacle (DJT14)
- MS27471** Solder Mount Hermetic Receptacle (DJT11)

CLASS

Y Hermetically Sealed

SHELL SIZE

9, 11, 13, 15, 17, 19, 21, 23, 25

FINISH

- F** Nickel
- G** Space Grade
- E** Stainless Steel, Passivated

MODIFICATIONS
L/C Less Contacts

POLARIZING POSITIONS
N Normal (omit from part number)
A, B, C, D (B and C not available in shell size 9)

CONTACTS
Hermetic Contacts
P Pin, Solder Cup
X Pin, Eyelet
C Pin, PC Tail

INSERT ARRANGEMENT
See Insert Arrangement Tables, pages 10-17 and 22-23

DEUTSCH Part Numbering System

DJT 1 1 H 25 - 35 S D xxxx

GENERAL IDENTIFIER
DJT DEUTSCH MIL-DTL-38999 Series I

COUPLING SYSTEM

1 Bayonet

SHELL STYLE

- 4** Jam Nut Hermetic Receptacle (MS27470)
- 1** Solder Mount Hermetic Receptacle (MS27471)

CLASS

H Hermetic

SHELL SIZE

09, 11, 13, 15, 17, 19, 21, 23, 25

POLARIZING POSITIONS
N Normal
A, B, C, D (B and C not available in shell size 9)

CONTACTS
Hermetic Contacts
P Pin, Solder Cup
X Pin, Eyelet
C Pin, PC Tail

INSERT ARRANGEMENT
See Insert Arrangement Tables, pages 10-17 and 22-23

DJT and Military Insert	09-07	09-35	09-98	11-02	11-04	11-05	11-35	11-98	11-99	13-04	13-08	13-35	13-98	15-05	15-15	15-18	15-19	15-26	15-35	15-97	17-02	17-03	17-06	17-08	17-11
QPL Hermetic		✓	✓	✓	✓		✓	✓	✓	✓	✓	✓	✓	✓	✓	✓	✓		✓	✓					
DJT and Military Insert	17-19	17-20	17-22	17-24	17-26	17-35	17-99	19-11	19-18	19-19	19-28	19-32	19-35	21-11	21-16	21-20	21-35	21-39	21-41	21-48	21-75	21-76	23-06	23-21	23-35
QPL Hermetic																									
DJT and Military Insert	23-53	23-54	23-55	23-63	25-04	25-07	25-08	25-09	25-10	25-17	25-19	25-20	25-21	25-24	25-29	25-35	25-37	25-43	25-46	25-47	25-61	25-90	25-91		
QPL Hermetic					✓					✓				✓	✓	✓	✓	✓			✓				

MIL-DTL-38999 Series I

DEUTSCH DJT Series Connectors

Front Panel Mount Square Flange Receptacle

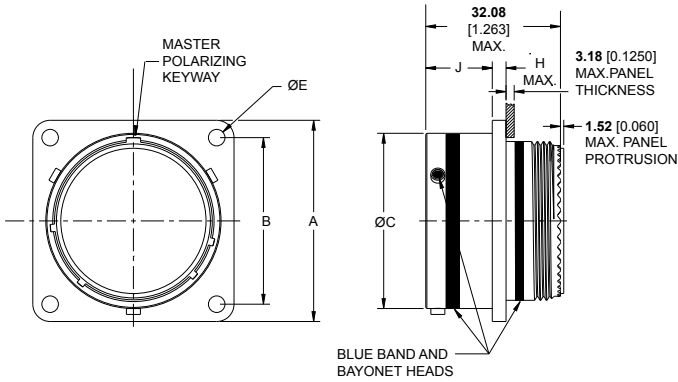

Shell Size	A ±0.51 (0.020)	B ±0.13 (0.005)	C ±0.08 (0.003)	E +0.25 ± 0.25/-0.13 (+0.010/ -0.005)	F	G ±0.13 (0.005)	H	J +0.00 / -0.13 (0.005)
09	23.83 0.938	18.26 0.719	14.48 0.570	3.25 0.128	13.11 0.516	3.25 0.128	2.54 0.100	16.05 0.623
11	26.19 1.031	20.62 0.812	17.73 0.698	3.25 0.128	16.87 0.664	3.25 0.128	2.54 0.100	16.05 0.623
13	28.58 1.125	23.01 0.906	21.54 0.848	3.25 0.128	19.05 0.750	3.25 0.128	2.54 0.100	16.05 0.623
15	30.96 1.219	24.61 0.969	24.71 0.973	3.25 0.128	23.01 0.906	3.25 0.128	2.54 0.100	16.05 0.623
17	33.32 1.312	26.97 1.062	27.89 1.098	3.25 0.128	25.81 1.016	3.25 0.128	2.54 0.100	16.05 0.623
19	36.53 1.438	29.36 1.156	30.61 1.205	3.25 0.128	28.98 1.141	3.25 0.128	2.54 0.100	16.05 0.623
21	39.67 1.562	31.75 1.250	33.78 1.330	3.25 0.128	32.16 1.266	3.25 0.128	3.30 0.130	15.29 0.602
23	42.88 1.688	34.93 1.375	36.96 1.455	3.73 0.147	34.98 1.377	3.91 0.154	3.30 0.130	15.29 0.602
25	46.02 1.812	38.10 1.500	40.13 1.580	3.73 0.147	37.69 1.484	3.91 0.154	3.30 0.130	15.29 0.602

Millimeters Inches

Jam Nut Receptacle

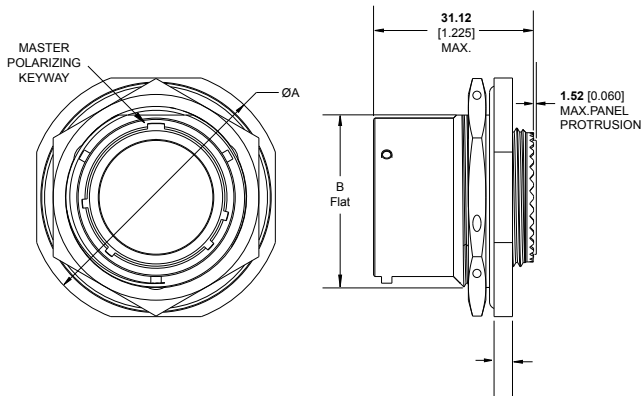

Shell Size	ØA ±0.41 (0.016)	B Flat +0.000 / -0.25 (0.010)	F +0.000 / -0.25 (0.010)	ØG +0.000 / -0.25 (0.010)
09	30.18 1.188	16.64 0.655	17.02 0.670	17.78 0.700
11	34.93 1.375	19.18 0.755	19.58 0.771	20.96 0.825
13	38.10 1.500	23.93 0.942	24.26 0.955	25.65 1.010
15	41.28 1.625	27.08 1.066	27.56 1.085	28.83 1.135
17	44.45 1.750	30.25 1.191	30.73 1.210	32.00 1.260
19	49.23 1.938	33.43 1.316	33.91 1.335	35.18 1.385
21	52.37 2.062	36.60 1.441	37.08 1.460	38.35 1.510
23	55.58 2.188	39.78 1.566	40.26 1.585	41.53 1.635
25	58.72 2.312	42.95 1.691	43.43 1.710	44.70 1.760

Millimeters Inches

Rear Panel Wall Mount Square Flange Receptacle

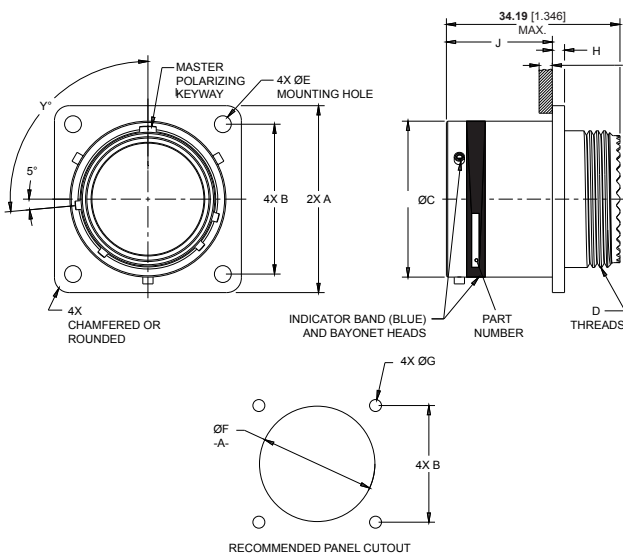

Shell Size	A 30.51 (0.020)	B 30.13 (0.005)	C 30.08 (0.003)	D THREAD UNEF-2A	ØE +0.25-0.13 (+0.010-0.005)	ØF Min.	ØG 30.13 (0.005)	H +0.38-0.00 (+0.015-0.000)	J +0.00-0.13 (+0.000-0.005)
09	23.83 0.938	18.26 0.719	14.48 0.570	11.11-28 0.4375-28	3.25 0.128	13.11 0.516	3.25 0.128	2.16 0.085	20.83 0.820
11	26.19 1.031	20.62 0.812	17.73 0.698	14.29-24 0.5625-24	3.25 0.128	16.87 0.664	3.25 0.128	2.16 0.085	20.83 0.820
13	28.58 1.125	23.01 0.906	21.54 0.848	17.46-24 0.6875-24	3.25 0.128	19.05 0.750	3.25 0.128	2.16 0.085	20.83 0.820
15	30.96 1.219	24.61 0.969	24.71 0.973	20.64-20 0.8125-20	3.25 0.128	23.01 0.906	3.25 0.128	2.16 0.085	20.83 0.820
17	33.32 1.312	26.97 1.062	27.89 1.098	23.81-20 0.9375-20	3.25 0.128	25.81 1.016	3.25 0.128	2.16 0.085	20.83 0.820
19	36.53 1.438	29.36 1.156	30.61 1.205	26.99-18 1.0625-18	3.25 0.128	28.98 1.141	3.25 0.128	2.16 0.085	20.83 0.820
21	39.67 1.562	31.75 1.250	33.78 1.330	30.16-18 1.1875-18	3.25 0.128	32.16 1.266	3.25 0.128	2.92 0.115	20.07 0.790
23	42.88 1.688	34.93 1.375	36.96 1.455	33.34-18 1.3125-18	3.73 0.147	34.98 1.377	3.91 0.154	2.92 0.115	20.07 0.790
25	46.02 1.812	38.10 1.500	40.13 1.580	36.51-18 1.4375-18	3.73 0.147	37.69 1.484	3.81 0.150	2.92 0.115	20.07 0.790

Millimeters Inches

MIL-DTL-38999 Series I

DEUTSCH DJT Series Connectors

Plug: Type MS27467 / DEUTSCH DJT16

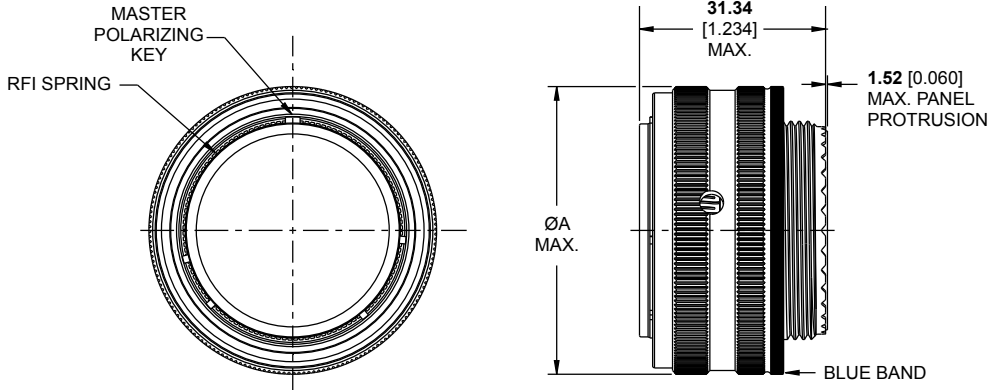

Shell Size	A
09	21.82 .859
11	24.99 .984
13	29.36 1.156
15	32.54 1.281
17	35.71 1.406
19	38.51 1.516
21	41.68 1.641
23	44.86 1.766
25	48.03 1.891

Millimeters Inches

Recommended Panel Cutouts

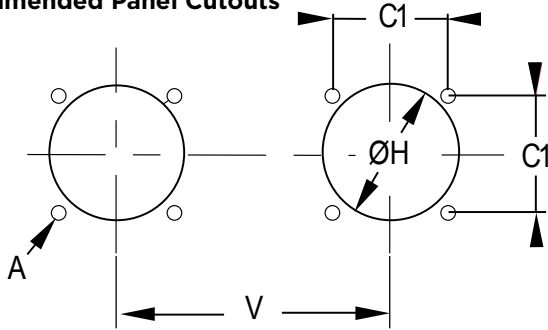

Square Flange Receptacle

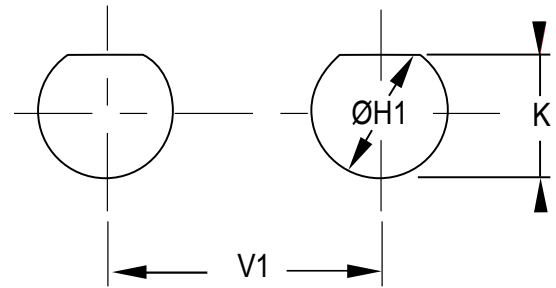

Jam Nut Receptacle (Type 24)

Shell Size	B ±0.13 (0.005)	F	G ±0.13 (0.005)
09	18.26 0.719	13.11 0.516	3.25 0.128
11	20.62 0.812	16.87 0.664	3.25 0.128
13	23.01 0.906	19.05 0.750	3.25 0.128
15	24.61 0.969	23.01 0.906	3.25 0.128
17	26.97 1.062	25.81 1.016	3.25 0.128
19	29.36 1.156	28.98 1.141	3.25 0.128
21	31.75 1.250	32.16 1.266	3.25 0.128
23	34.93 1.375	34.98 1.377	3.91 0.154
25	38.10 1.500	37.69 1.484	3.91 0.154

Millimeters Inches

Shell Size	F +.000 / -.25 (0.010)	ØG +.000 / -.25 (0.010)
09	17.02 0.670	17.78 0.700
11	19.58 0.771	20.96 0.825
13	24.26 0.955	25.65 1.010
15	27.56 1.085	28.83 1.135
17	30.73 1.210	32.00 1.260
19	33.91 1.335	35.18 1.385
21	37.08 1.460	38.35 1.510
23	40.26 1.585	41.53 1.635
25	43.43 1.710	44.70 1.760

Millimeters Inches

MIL-DTL-38999 Series III

**RELIABLE**

- Self-locking threaded coupling

EMI PROTECTED

- Grounding fingers for excellent EMI protection
- Metal-to-metal bottoming for maximum EMI grounding protection
- Connector is grounded when the shells meet, even before the contacts are engaged
- Trapezoidal thread for excellent shell-to-shell continuity

VERSATILE

- Variety of shell materials and finishes
- Wide range of backshells and accessories

Description

TE Connectivity (TE)'s DEUTSCH DTS series intermates with all qualified Series III plugs. Qualified receptacles feature DEUTSCH developed direct glass-to-metal sealing, nickel or stainless finishes and solder cup or eyelet terminated pin type contacts. TE also offers special application receptacles, including socket type contacts, total and patterned bussed contacts and contacts to terminate flex tape and printed circuit boards. Consult TE regarding availability.

MATERIALS

- **Hermetic Seal:** Sintered glass

ENVIRONMENTAL

- **Temperature Range:** -67°F to +392°F
- **Vibration:** Exceeds requirements of MIL-STD-1344, method 2005 per MIL-C-38999
- **Physical Shock:** No unlocking or electrical discontinuity when tested per MIL-STD-1344, method 2004 at half sine wave of 300 gs
- **Air Leakage:** Less than 0.1 micron cu. ft./hr. at 15 psi differential per MIL-C-38999 and MIL-STD-1344, method 1008
- **Durability:** 500 cycles of engagement per MIL-C-38999
- **Moisture Resistance:** Meets requirements of MIL-C-38999
- **Corrosion:** Exceeds requirements of MIL-STD-1344 method 1001 per Mil-C-38999 using standard plating
- **Usable Wire Size:**
#22D Contacts: #22 AWG Max **#20 Contacts:** #18 AWG Max
#16 Contacts: #16 AWG Max **#12 Contacts:** #12 AWG Max

ELECTRICAL

- **Dielectric Withstanding Voltage at Sea Level:**
#22D Contacts: 1300 V AC rms @ 60Hz
#20 Contacts: 2300 V AC rms @ 60Hz
#16 Contacts: 2300 V AC rms @ 60Hz
- **Current Rating:**
#22D Contacts: 5.0 amps **#20 Contacts:** 7.5 amps
#16 Contacts: 25 amps **#12 Contacts:** 40 amps
- **Contact Resistance:**
#22D: 85 mVoLs @ 3 amps **#20:** 60 mVoLs @ 5 amps
#16: 85 mVoLs @ 10 amps **#12:** 85 mVoLs @ 17 amps
- **Insulation Resistance:** 5000 Meg ohms min @ 75°F per MIL-C-38999
- **Thermal Shock:** No deterioration or failure after 5 cycles @ -67°F to +392°F
- **Leakage:** 1.10^{-6} mbar.l.s-1 under 1 bar vacuum or 0.36 mm³/h (as per the EN2591-322)
- **Thermal Shock:** 10 cycles, 4°C max. to 90°C min.

STANDARDS AND SPECIFICATIONS

- Qualified to MIL-C-38999

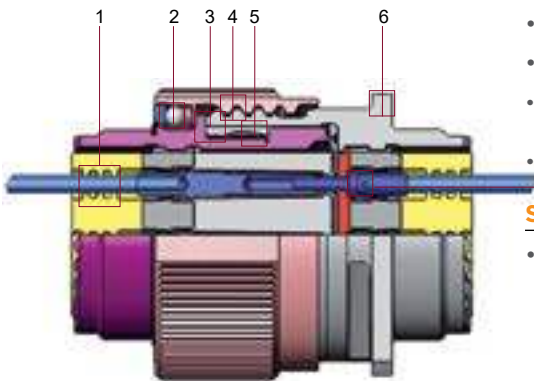

MIL-DTL-38999 Series III

Voltage Rating

Service Rating	Suggested Operating Voltage		Test Voltage at Altitude (VAC _{rms})			
	VAC _{rms}	VDC	Sea Level	50,000 Ft.	70,000 Ft.	100,000 Ft.
M	400	550	1300	550	350	200
N	300	450	1000	400	260	200
I	600	850	1800	600	400	200
II	750	1050	2300	800	500	200

Current Rating

Contact Size	Test Current (A)	Voltage Drop (mV)
23	3	73
22D	5	73
20	7.5	55
16	13	50
12	23	42
10	33	34
8*	46	26

*When commercial power contact replaces twin-ax contact

Thread Sizes

Shell Size	Accessory Thread (6g 0.100R)	Mating Thread (0.1P-0.3L)	Jam Nut Thread (6g 0.100R)
9	M12 x 1.0	.6250	M17 x 1.0
11	M15 x 1.0	.7500	M20 x 1.0
13	M18 x 1.0	.8750	M25 x 1.0
15	M22 x 1.0	1.0000	M28 x 1.0
17	M25 x 1.0	1.1875	M32 x 1.0
19	M28 x 1.0	1.2500	M35 x 1.0
21	M31 x 1.0	1.3750	M38 x 1.0
23	M34 x 1.0	1.5000	M41 x 1.0
25	M37 x 1.0	1.6250	M44 x 1.0

DEUTSCH Base Part No.	Mil Cross Type	Receptacle Mounting	Variations		
			Mil Classes	Mil Finishes	Contact Styles
Series III: Scoop-Proof, Triple Start, Self-Locking, Threaded Coupling					
DTS20	D38999/21	Square Flange	H Space Grade N Nickel-Plated Stainless Steel Y Electropolished Stainless Steel	—	P Pin, Solder Cup X Pin, Eyelet C Pin, PCB Flex Feedthrough
DTS24	D38999/23	Jam Nut		—	
DTS21	D38999/25	Solder Mount		—	
DTS23	D38999/27	Weld Mount		—	

MIL-DTL-38999 Series III

Part Numbering MIL-DTL-38999 and DEUTSCH Commercial Versions

Commercial AI/SS	DTS	20	F	15	35	P	N	XXXX	
Military	D38999	/21	F	D	35	P	N	XXXX	

COMM	MILITARY								MODIFICATION CODE
RANGE									KEYING
DTS	D38999								N, A, B, C, D, E, U
									N = Normal, U = Universal
STYLE									CONTACTS
20	/21	Hermetic Square Flange Receptacle							Hermetic Contacts
24	/23	Hermetic Jam Nut Receptacle							P Pin, Solder Cup
21	/25	Hermetic Solder Flange							X Pin, Eyelet
23	/27	Hermetic Weld Flange							C Pin, PC Tail
CLASS									INSERT ARRANGEMENTS
HERMETIC									See Insert Arrangement Tables,
Y	Y	Stainless Steel, Passivated							pages x-x and x-x
N	N	Stainless Steel, Electrodeposited Nickel Plated							
H	H	Space Grade							
SHELL SIZES									

9 (A), 11 (B), 13 (C), Numbers = DTS Commercial;
 15 (D), 17 (E), 19 (F), (Letters) = Military/ACT Commercial
 21 (G), 23 (H), 25 (J)

Keying Options

(Viewed from Mating Face of the Receptacle Connector)

Shell Size	Key Position	Polarization (Degrees)			
		A	B	C	D
09	N	105	140	215	265
	A	102	132	248	320
	B	80	118	230	312
	C	35	140	205	275
	D	64	155	234	304
	E	91	131	197	240
11, 13, 15	N	95	141	208	236
	A	113	156	182	292
	B	90	145	195	252
	C	53	156	220	255
	D	119	146	176	298
	E	51	141	184	242
17, 19, 21, 23, 25	N	80	142	196	293
	A	135	170	200	310
	B	49	169	200	244
	C	66	140	200	257
	D	62	145	180	280
	E	79	153	197	272

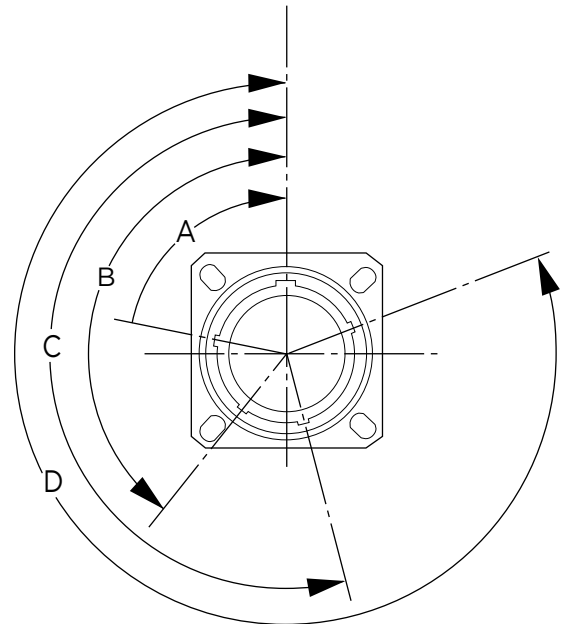

MIL-DTL-38999 Series III

DEUTSCH DTS Series Connectors

Square Flange Receptacle: Type 20

Shell Size	B	C1	C2	D Max.	E Max.	F	G	P	PP	Mass (g) by Shell Type		
										Al	SS	Composite
09	23.80 0.937	18.26 0.719	15.09 0.594	20.90 0.823	2.50 0.098	15.75 0.620	11.90 0.469	3.25 0.128	5.49 0.216	10	27	9
11	26.20 1.031	20.62 0.812	18.26 0.719	20.90 0.823	2.50 0.098	18.90 0.744	14.90 0.587	3.25 0.128	4.93 0.194	16	36	11
13	28.60 1.126	23.01 0.906	20.62 0.812	20.90 0.823	2.50 0.098	22.10 0.870	17.90 0.705	3.25 0.128	4.93 0.194	19	45	14
15	31.00 1.220	24.61 0.969	23.01 0.906	20.90 0.823	2.50 0.098	25.25 0.994	21.90 0.862	3.25 0.128	4.93 0.194	25	56	18
17	33.30 1.311	26.97 1.062	24.61 0.969	20.90 0.823	2.50 0.098	29.95 1.179	24.90 0.980	3.25 0.128	4.93 0.194	32	74	23
19	36.50 1.437	29.36 1.156	26.97 1.062	20.90 0.823	2.50 0.098	31.55 1.242	27.90 1.098	3.25 0.128	4.93 0.194	39	78	26
21	39.70 1.563	31.75 1.250	29.36 1.156	20.10 0.791	3.20 0.126	34.70 1.366	30.90 1.217	3.25 0.128	4.93 0.194	45	95	31
23	42.90 1.689	34.93 1.375	31.75 1.250	20.10 0.791	3.20 0.126	37.90 1.492	33.90 1.335	3.91 0.154	6.15 0.242	54	108	36
25	46.00 1.811	38.10 1.500	34.93 1.375	20.10 0.791	3.20 0.126	41.10 1.618	36.90 1.453	3.91 0.154	6.15 0.242	59	120	43

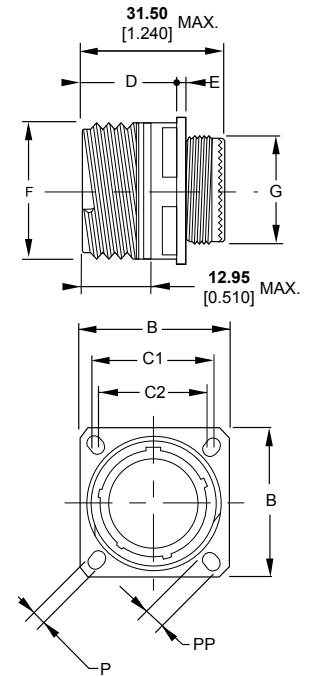

Millimeters Inches

Jam Nut Receptacle: Type 24

Shell Size	A	B	E	F	G	M Max.	Mass (g) by Shell Type		
							Al	SS	Composite
09	30.20 1.189	27.00 1.063	2.20 0.087	15.75 0.620	11.90 0.469	24.00 0.945	15	40	11
11	34.90 1.374	31.80 1.252	2.20 0.087	18.90 0.744	14.90 0.587	27.00 1.063	21	50	14
13	38.10 1.500	34.90 1.374	2.20 0.087	22.10 0.870	17.90 0.705	32.00 1.260	27	60	18
15	41.30 1.626	38.10 1.500	2.20 0.087	25.25 0.994	21.90 0.862	36.00 1.417	32	72	23
17	44.50 1.752	41.30 1.626	2.20 0.087	29.95 1.179	24.90 0.980	37.00 1.457	40	92	29
19	49.20 1.937	46.00 1.811	3.00 0.118	31.55 1.242	27.90 1.098	41.00 1.614	49	96	35
21	52.40 2.063	49.20 1.937	3.00 0.118	34.70 1.366	30.90 1.217	46.00 1.811	54	114	38
23	55.60 2.189	52.40 2.063	3.00 0.118	37.90 1.492	33.90 1.335	50.00 1.969	65	130	46
25	58.70 2.311	55.60 2.189	3.00 0.118	41.10 1.618	36.90 1.453	51.23 2.017	73	143	55

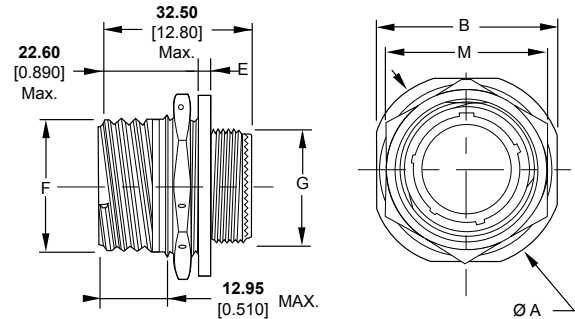

Millimeters Inches

Plug: Type 26

Shell Size	F Max.	G	S Max.	Mass (g) by Shell Type		
				Al	SS	Composite
09	18.40 0.724	11.90 0.469	21.80 0.858	15	36	9
11	21.10 0.831	14.90 0.587	25.00 0.984	20	50	13
13	25.40 1.000	17.90 0.705	29.40 1.157	27	64	18
15	28.70 1.130	21.90 0.862	32.50 1.280	34	80	23
17	32.20 1.268	24.90 0.980	35.70 1.406	37	88	25
19	34.90 1.374	27.90 1.098	38.50 1.516	48	102	32
21	38.10 1.500	30.90 1.217	41.70 1.642	55	117	35
23	41.10 1.618	33.90 1.335	44.90 1.768	67	131	41
25	44.30 1.744	36.90 1.453	48.00 1.890	71	145	48

Millimeters Inches

Coupling Torque: Plug to Receptacle

Shell Size	Engagement and Disengagement (Max.)		Minimum Disengagement	
	Nm	Lb.-in.	Nm	Lb.-in.
09	0.9	8	0.2	2
11	1.4	12		
13	1.8	16		
15	2.3	20	0.3	3
17	2.7	24		
19	3.2	28		
21	3.6	32		
23	4.1	36	0.6	5
25	4.6	40		

MIL-DTL-38999 Series III

DEUTSCH DTS Series Connectors

Mated/Unmated Dimensions

Square Flange Receptacle to Plug

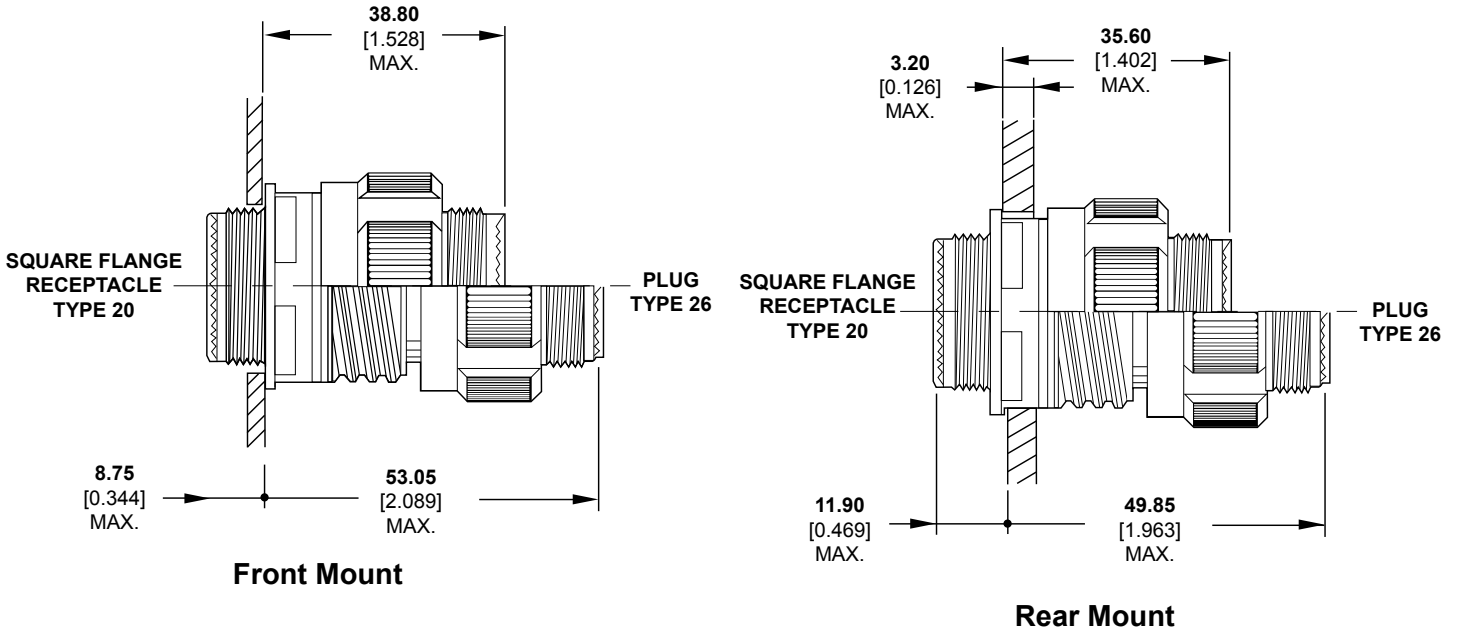

Jam Nut Receptacle to Plug

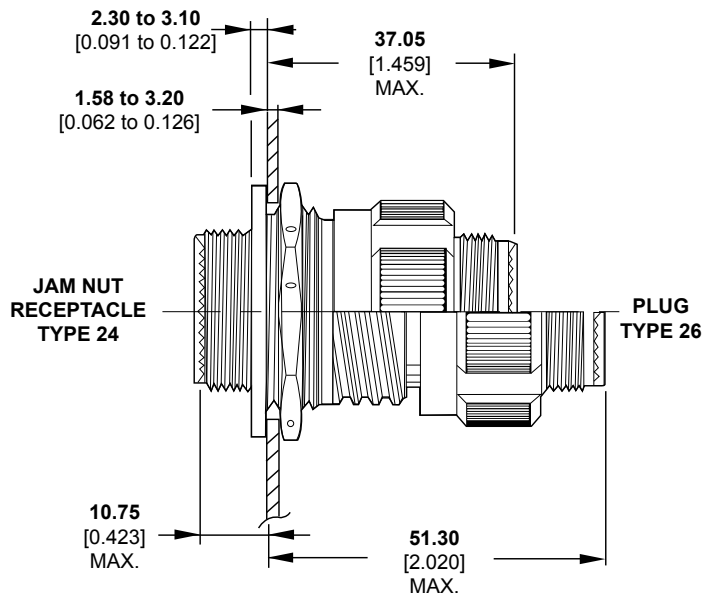

MIL-DTL-38999 Series III

DEUTSCH DTS Series Connectors

Recommended Panel Cutouts

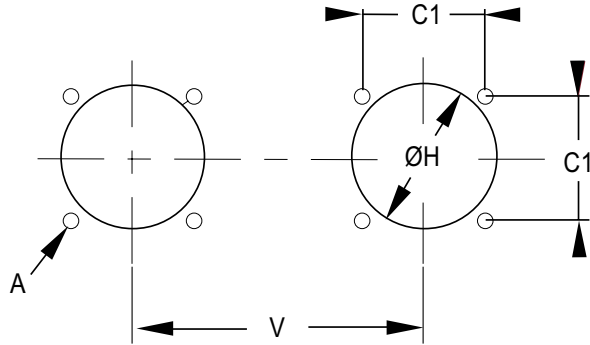

Square Flange Receptacle

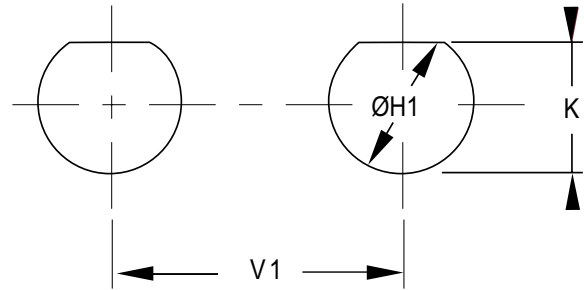

Jam Nut Receptacle

Shell Size	A	C1	H Min.		H1 Max.	K Max.	V Min.	V1 Min.
			Front	Rear				
9	3.25 0.128	18.26 0.719	13.11 0.516	16.66 0.656	17.78 0.700	16.70 0.657	25.58 1.007	20.20 1.189
11		20.62 0.812	15.08 0.594	22.22 0.875	20.88 0.822	19.53 0.769	27.00 1.063	32.60 1.283
13		23.01 0.906	19.05 0.750	23.42 0.922	25.58 1.007	24.26 0.995	30.20 1.189	36.00 1.417
15		24.61 0.969	23.01 0.906	26.59 1.047	28.80 1.134	27.53 1.084	33.30 1.331	39.60 1.559
17		26.97 1.062	25.81 1.106	30.96 1.219	31.98 1.259	30.68 1.208	36.50 1.437	43.30 1.705
19		29.36 1.156	28.98 1.141	32.94 1.297	35.15 1.384	33.86 1.333	39.30 1.547	47.00 1.850
21		31.75 1.250	32.16 1.266	36.12 1.422	38.28 1.507	37.06 1.459	42.50 1.673	50.60 1.992
23	3.91 0.154	34.93 1.375	34.93 1.375	39.29 1.547	41.50 1.634	40.01 1.575	45.70 1.799	54.20 2.134
25		38.10 1.500	37.69 1.484	42.47 1.672	44.68 1.759	43.41 1.709	48.80 1.921	59.70 2.350

Millimeters Inches

MIL-DTL-38999 Series IV



DEUTSCH DIV Series Connectors

DEUTSCH DIV Series connectors from TE Connectivity (TE) are high-performance MIL-DTL-38999 connectors for use in high shock, vibration and EMI environments where reliability is essential.

MATERIALS

- **Shell:** Stainless steel, aluminum
- **Plating:** Passivated and electroless nickel
- **Insert:** Thermoplastic and fluorinated silicone elastomer
- **O-Ring:** Fluorinated silicone elastomer
- **Hermetic Seal:** Sintered glass

ENVIRONMENTAL

- **Temperature Range:**
 - 65°C to +175°C (Class W)
 - 65°C to +200°C (Classes C, F, Y and N)
- **Fluid Resistance:** Fluid immersion per EIA 364.10, including resistance to
 - MIL-PRF-5606: Hydraulic fluid
 - MIL-DTL-83133: JP-8 aviation fuel
 - MIL-PRF-7808: Lubricating oil
 - MIL-PRF-23699: Lubricating oil
 - MIL-A-8243: Deicing/defrosting fluid
 - MIL-C-25769: Aircraft cleaning compound
 - MIL-PRF-87937: Aircraft cleaning compound
 - MIL-G-3056: Gasoline
- **Salt Spray:**
 - 48 hours (Nickel finishes)
- **Thermal Cycling:** -65° to 150/175/200°C (max. temperature is class dependent)

MECHANICAL

- **Sine Vibration:** Up to 60 g for 36 hr.
- **Random Vibration:** Up to 41.7 g for 16 hr. at 175° C
Up to 50 g for 16 hr. at ambient temperature
- **Shock:** 300 g, 3 ms in the 3 axes
- **Durability:** >500 mating cycles
- **Contact Retention:**

Size 22D: 44 N (10 lb.)	Size 12: 111 N (25 lb.)
Size 20: 67 N (15 lb.)	Size 10: 111 N (25 lb.)
Size 16: 111 N (25 lb.)	Size 8: 111 N (25 lb.)

ELECTRICAL

- **Shell-to-Shell Conductivity:**
 - Passivated: 10.0 mV
 - Electroless Nickel: 1.0 mV
- **Leakage:** 1.10^{-6} mbar.l.s-1 under 1 bar vacuum or 0.36 mm³/h (as per the EN2591-322)
- **Thermal Shock:** 10 cycles, 4°C max. to 90°C min.

DEPENDABLE

- Secure breech lock coupling
- Pin-to-pin mating protection helps prevent failures

RUGGED

- Mated connectors help withstand high-impact shock
- Rear accessory threads help provide increased strength
- >500-mating-cycle durability
- Corrosion resistant

EMI PROTECTED

- Grounding fingers for excellent EMI protection
- Connector is grounded when the shells meet, even before the contacts are engaged

EASY INSTALLATION

- Blind-mateable grounding fingers to help provide a safer assembly during mating
- Requires only 90° rotation to engage and disengage

MIL-DTL-38999 Series IV

Voltage Rating

Service Rating	Suggested Operating Voltage		Test Voltage at Altitude (VAC _{rms})			
	VAC _{rms}	VDC	Sea Level	50,000 Ft.	70,000 Ft.	100,000 Ft.
M	400	550	1300	550	350	200
N	300	450	1000	400	260	200
I	600	850	1800	600	400	200
II	750	1050	2300	800	500	200

Current Rating

Contact Size	Test Current (A)	Voltage Drop (mV)
22D	5	73
20	7.5	55
16	13	50
12	23	42
10	33	34
8*	46	26

*When commercial power contact replaces twin-ax contact

Thread Sizes

Shell Size	Accessory Thread (6g 0.100R)	Jam Nut Thread (6g 0.100R)
11	M15 x 1.0	M20 x 1.0
13	M18 x 1.0	M25 x 1.0
15	M22 x 1.0	M28 x 1.0
17	M25 x 1.0	M32 x 1.0
19	M28 x 1.0	M35 x 1.0
21	M31 x 1.0	M38 x 1.0
23	M34 x 1.0	M41 x 1.0
25	M37 x 1.0	M44 x 1.0

DEUTSCH Base Part No.	Mil Cross Type	Receptacle Mounting	Variations		
			Mil Classes	Mil Finishes	Contact Styles
Series IV: Scoop-Proof, Breech Coupling					
DIV43H	D38999/41	Square Flange	H Space Grade N Nickel-Plated Stainless Steel Y Electropolished Stainless Steel	—	P Pin, Solder Cup X Pin, Eyelet C Pin, PCB Flex Feedthrough
DIV44H	D38999/43	Jam Nut		—	
DIV41H	D38999/45	Solder Mount		—	

MIL-DTL-38999 Series IV

Part Numbering MIL-DTL-38999 and DEUTSCH Commercial Versions

Commercial
Military

DIV **41 Y** **25 35 P** **N -L/C**
D38999 **45 Y** **J 35 P** **N -6139**

COMM MILITARY

RANGE
DIV D38999

STYLE
41 45 Hermetic Solder Mount Receptacle
44 43 Hermetic Jam Nut Receptacle

CLASS/FINISH
HERMETIC
Y Y Stainless Steel, Passivated
N N Stainless Steel, Electrodeposited Nickel Plated
H H Space Grade

SHELL SIZES
11 (B), 13 (C), Numbers = DIV Commercial;
15 (D), 17 (E), 19 (F), (Letters) = Military
21 (G), 23 (H), 25 (J)

MODIFICATION CODE
023* Use to Get Military Class W with Contacts
6149* Use for Mil Class F Less Contacts
6139* Use for Mil Class W Less Contacts
L/C* Less Contacts
Less Contacts

POLARIZING POSITIONS
N Normal
A, B, C, D, K

CONTACTS
Hermetic Contacts
P Pin, Solder Cup
X Pin, Eyelet
C Pin, PC Tail

INSERT ARRANGEMENTS
See Insert Arrangement Tables,
pages x-x and x-x

DIV and Military Insert	11-02	11-04	11-05	11-35	11-98	11-99	13-04	13-08	13-35	13-98	15-05	15-15	15-18	15-19	15-26	15-35	15-97	17-02	17-03	17-06	17-08	17-11	17-19	17-20	17-22
QPL Hermetic	✓	✓	✓	✓	✓	✓	✓	✓	✓	✓	✓	✓	✓	✓		✓	✓			✓	✓				
DIV and Military Insert	17-24	17-26	17-35	17-99	19-11	19-18	19-19	19-28	19-32	19-35	21-11	21-16	21-20	21-35	21-39	21-41	21-48	21-75	21-76	23-06	23-21	23-35	23-53	23-54	23-55
QPL Hermetic			✓	✓	✓			✓		✓	✓	✓		✓	✓	✓					✓	✓	✓		✓
DIV and Military Insert	23-63	25-04	25-07	25-08	25-09	25-10	25-17	25-19	25-20	25-21	25-24	25-29	25-35	25-37	25-43	25-46	25-47	25-61	25-90	25-91					
QPL Hermetic		✓						✓			✓	✓	✓		✓			✓							

Keying Options

(Viewed from Mating Face of the Receptacle Connector)

Clocking	X° Ref.	Y° Ref.
N	110	250
A	100	260
B	90	270
C	80	280
D	70	290
K	120	255

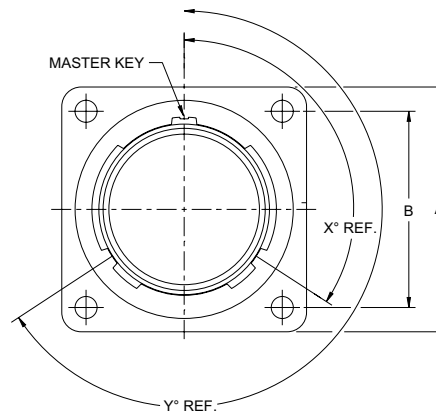

MIL-DTL-38999 Series IV

DEUTSCH DIV Series Connectors

Wall Mount/Square Flange Receptacle

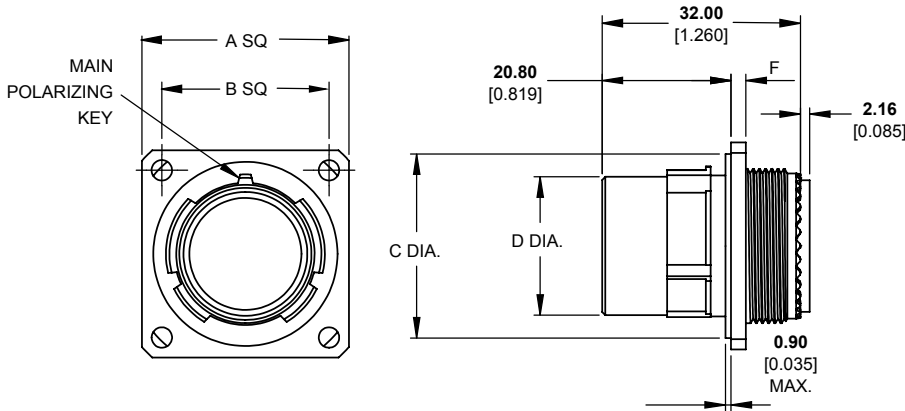

Shell Size	A Sq. Max.	B Sq.	ØC Max.	ØD Max.	F
11	26.70 1.051	20.62 0.812	20.15 0.793	12.93 0.509	2.60 0.102
13	29.10 1.146	23.02 0.906	23.35 0.919	16.10 0.634	2.60 0.102
15	31.50 1.240	24.62 0.970	26.52 1.044	19.28 0.759	2.60 0.102
17	33.90 1.335	26.98 1.062	29.72 1.170	22.48 0.885	2.60 0.102
19	37.10 1.461	29.36 1.156	32.87 1.294	25.63 1.009	2.60 0.102
21	40.20 1.583	31.76 1.250	36.05 1.419	28.80 1.134	3.40 0.133
23	43.40 1.709	34.92 1.374	39.22 1.544	31.98 1.259	3.40 0.133
25	46.60 1.835	38.10 1.500	42.40 1.669	35.15 1.384	3.40 0.133

Millimeters Inches

Jam Nut Receptacle

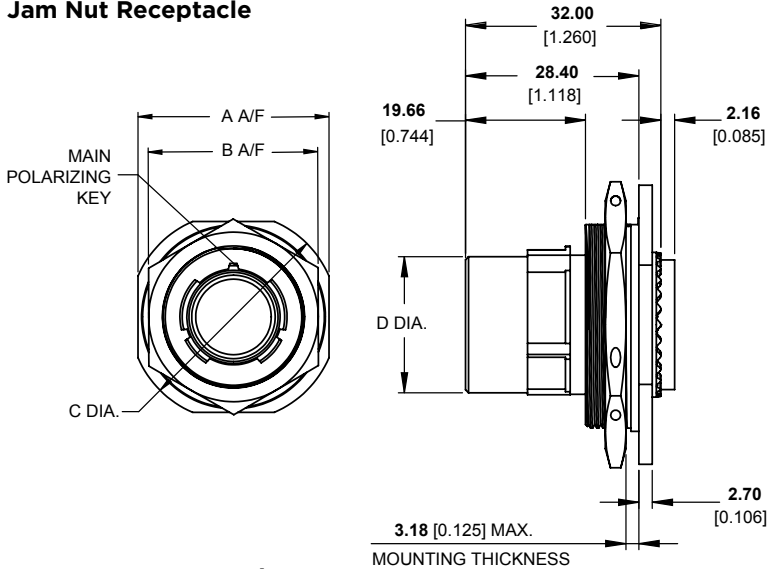

Shell Size	A A/F Max.	B A/F Max.	C Dia. Max.	D Dia. Max.
11	35.40 1.394	32.00 1.260	38.60 1.520	12.93 0.509
13	38.60 1.520	36.00 1.417	41.70 1.642	16.10 0.634
15	41.70 1.642	41.00 1.614	44.90 1.768	19.28 0.759
17	45.70 1.799	41.00 1.614	49.70 1.957	22.48 0.885
19	48.50 1.909	46.00 1.811	51.70 2.035	25.63 1.009
21	51.70 2.035	50.00 1.968	54.80 2.157	28.80 1.134
23	54.80 2.157	50.00 1.968	58.00 2.283	31.98 1.259
25	58.00 2.283	55.00 2.165	61.20 2.409	35.15 1.384

Millimeters Inches

Box Mount Receptacle

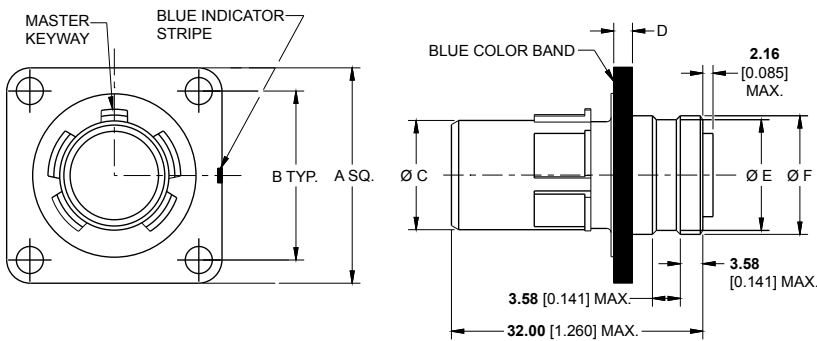

Shell Size	A Sq. Max.	B Sq.	ØC Max.	D	ØE	ØF
11	26.70 1.051	20.62 0.812	20.15 0.793	2.60 0.102	13.41 0.528	14.50 0.571
13	29.10 1.146	23.02 0.906	23.35 0.919	2.60 0.102	16.31 0.642	17.40 0.685
15	31.50 1.240	24.62 0.970	26.52 1.044	2.60 0.102	19.41 0.764	20.60 0.811
17	33.90 1.335	26.98 1.062	29.72 1.170	2.60 0.102	22.61 0.890	23.80 0.937
19	37.10 1.461	29.36 1.156	32.87 1.294	2.60 0.102	25.30 0.996	26.52 1.044
21	40.20 1.583	31.76 1.250	36.05 1.419	3.40 0.133	28.52 1.123	29.620 1.166
23	43.40 1.709	34.92 1.374	39.22 1.544	3.40 0.133	31.70 1.248	32.82 1.292
25	46.60 1.835	38.10 1.500	42.40 1.669	3.40 0.133	34.82 1.371	36.02 1.418

Millimeters Inches

MIL-DTL-38999 Series IV

DEUTSCH DIV Series Connectors

Plug

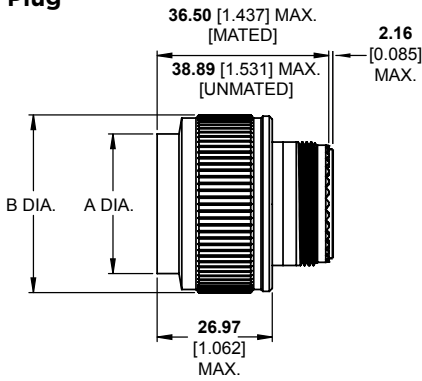

Shell Size	Ø A Max.	Ø B Max.
11	26.60 1.047	19.70 0.775
13	31.00 1.220	22.90 0.901
15	34.20 1.346	26.40 1.039
17	37.40 1.472	29.20 1.149
19	40.20 1.583	32.40 1.275
21	43.30 1.704	35.60 1.401
23	46.50 1.831	38.80 1.527
25	49.70 1.957	41.90 1.649

Millimeters Inches

Recommended Panel Cutouts

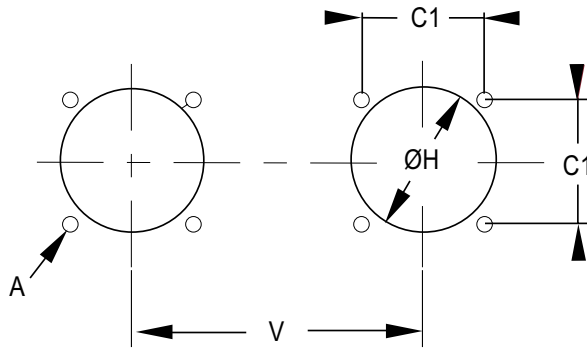

Square Flange Receptacle

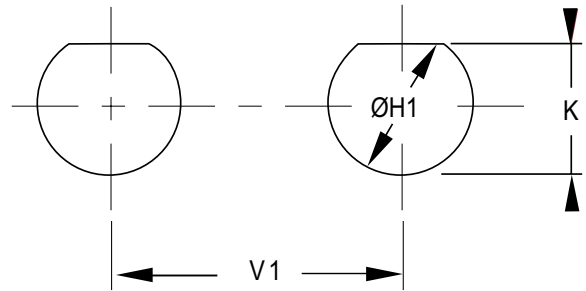

Jam Nut Receptacle

Shell Size	C1	H Min.		H1 Max.	K Max.	V Min.	V1 Min.
		Front	Rear				
11	20.62 0.812	15.08 0.594	22.22 0.875	20.88 0.822	19.53 0.769	27.00 1.063	32.60 1.283
13	23.01 0.906	19.05 0.750	23.42 0.922	25.58 1.007	24.26 0.995	30.20 1.189	36.00 1.417
15	24.61 0.969	23.01 0.906	26.59 1.047	28.80 1.134	27.53 1.084	33.30 1.331	39.60 1.559
17	26.97 1.062	25.81 1.106	30.96 1.219	31.98 1.259	30.68 1.208	36.50 1.437	43.30 1.705
19	29.36 1.156	28.98 1.141	32.94 1.297	35.15 1.384	33.86 1.333	39.30 1.547	47.00 1.850
21	31.75 1.250	32.16 1.266	36.12 1.422	38.28 1.507	37.06 1.459	42.50 1.673	50.60 1.992
23	34.93 1.375	34.93 1.375	39.29 1.547	41.50 1.634	40.01 1.575	45.70 1.799	54.20 2.134
25	38.10 1.500	37.69 1.484	42.47 1.672	44.68 1.759	43.41 1.709	48.80 1.921	59.70 2.350

Millimeters Inches

EN3646 / FDDB Series

**MATING COMPATIBILITY**

- DEUTSCH RR/602 connectors
- ASNE connectors

VERSATILE

- Wide range of connector

SHELL CONFIGURATIONS

- Configurable filter topologies

RELIABLE

- Positive bayonet coupling
- High durability silicone elastomers

DESIGNED FOR HARSH ENVIRONMENTS

- Vibration and shock
- Temperature extremes
- High humidity
- Altitude
- Salt spray

DEUTSCH FDDB Series connectors were developed from the NAS1599B specification. The lightweight connectors offer medium-density insert arrangements, various plating options, five different keying options, and a bayonet coupling requiring only a 1/3 turn to mate fully.

ENVIRONMENTAL

- **Temperature Range:** -55°C to +200°C
- **Physical Shock:** 50g in the 3 axes
- **Thermal Shock:** Hermetic version: 10 cycles from - 55°C to + 200°C
Aluminum hermetic version: 10 cycles from - 55°C to + 200°C,
1 cycle 10 H/200°C
- **Vibration:** In accordance with MIL-STD 202 method 204, condition B
- **Pressure Resistance:** Up to 70 bars. Consult us for other pressure requirements
- **Fungus Resistance:** Based on MIL-STD-810
- **Air Leakage:** ≤ 1.10–6 mbar.l/s under 1 bar vacuum
- **Fluid Resistance:** (in accordance with BES/SST/ELC/321/Prod. and MIL-C-26482). Skydrol oil, JP5 fuel, engine oils and hydraulic fluids
- **Fluid Immersion:** Typical as per MIL-DTL-26482 classes H, L and N (Table XXIX)
- **Salt Spray:** Nickel - 48 hours
- **Humidity:** Typically EIA-364-31 test method II
- **Durability:** 500 full coupling and uncoupling cycles

MECHANICAL

- **Shell Material:** Stainless steel
- **Plating:** Nickel
- **Insert Material:** Sintered glass
- **Contacts Material and Plating:** Ferrous alloy - gold over nickel - solder type

ELECTRICAL

- **Withstand Voltage (at Sea Level):**
 - Service 1 - 1500 V eff. 50Hz
 - Service 2 - 2300 V eff. 50Hz
- **Service Voltage:** 500 V eff. 50 Hz
- **Grounded Line Resistance (Typ.):** 15 mΩ
- **Insulation Resistance:** ≥ to 5000 MΩ to 25°C and 60% HR
- **Contacts Maximum Current:**
 - Aluminum Hermetic Version**
 - Size 20: 7.5 A max.
 - Size 16: 13 A max.
 - Size 12: 23 A max.
 - Steel Hermetic Version**
 - Size 20: 5 A max.
 - Size 16: 10 A max.
 - Size 12: 17 A max.
- **Contact Resistance:**
 - Aluminum Hermetic Version**
 - Size 20: 3 mΩ under max intensity
 - Size 16: 2 mΩ under max intensity
 - Size 12: 1.5 mΩ under max intensity

EN3646 / FDDBA Series

Steel Hermetic Version

- Size 20: 21 mΩ under max intensity
- Size 16: 14 mΩ under max intensity
- Size 12: 11 mΩ under max intensity

- **Allowed Wires Section:**

- Size 20: 0.21 to 0.93 mm²
- Size 16: 0.60 to 1.34 mm²
- Size 12: 1.91 to 3.18 mm²

Dielectric Withstand (Typ.): <5 μA

- **DWV:** up to 2000 VDC

- **Working Voltage:** up to 2000 VDC

- **Typical Test Specifications Used:**

MIL-STD-810: Test Method Standard

MIL-STD-202: Electrical & Electronic Component Parts

RTCA DO-160: Test Procedures for Airborne Equipment

EIA-364: Electrical Connector & Socket Test Procedures

Arrangements

Male Insert: Front Face View



8-3A/8-98
3 Size 20
Contacts



8-33
3 Size 20
Contacts



8 E1
1 Quadrax
Contact



10-6
6 Size 20
Contacts



12-3
3 Size 16
Contacts



12-8
8 Size 20
Contacts



12-10
10 Size 20
Contacts

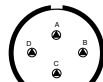

14-4
4 Size 12
Contacts

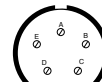

14-5
5 Size 16
Contacts



14-12
8 Size 20 Contacts
4 Size 16 Contacts

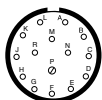

14-15
14 Size 20 Contacts
1 Size 16 Contact

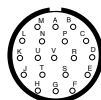

14-19
19 Size 20 Contacts

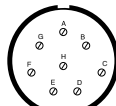

16-8
8 Size 16
Contacts

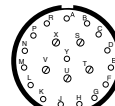

16-21
16 Size 20 Contacts
5 Size 16 Contacts

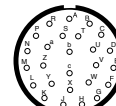

16-26
26 Size 20 Contacts

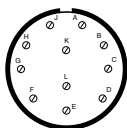

18-11
11 Size 16
Contacts

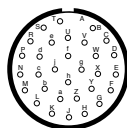

18-32
32 Size 20
Contacts

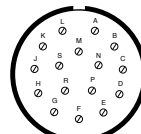

20-16
16 Size 16
Contacts

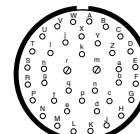

20-39
37 Size 20 Contacts
2 Size 16 Contacts

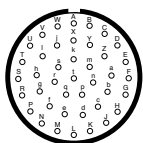

20-41
41 Size 20
Contacts

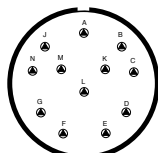

22-12
12 Size 12
Contacts

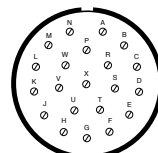

22-21
21 Size 16
Contacts

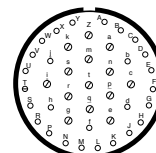

22-41
27 Size 20 Contacts
14 Size 16 Contacts

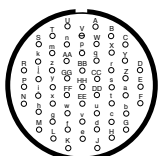

22-55
55 Size 20
Contacts

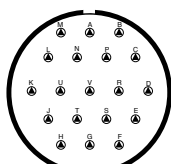

24-19
19 Size 12
Contacts

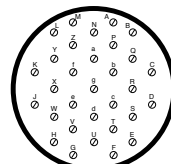

24-31
31 Size 16
Contacts

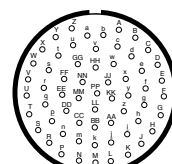

24-61
61 Size 20
Contacts

Hermetic Receptacles

DEUTSCH Part Numbering

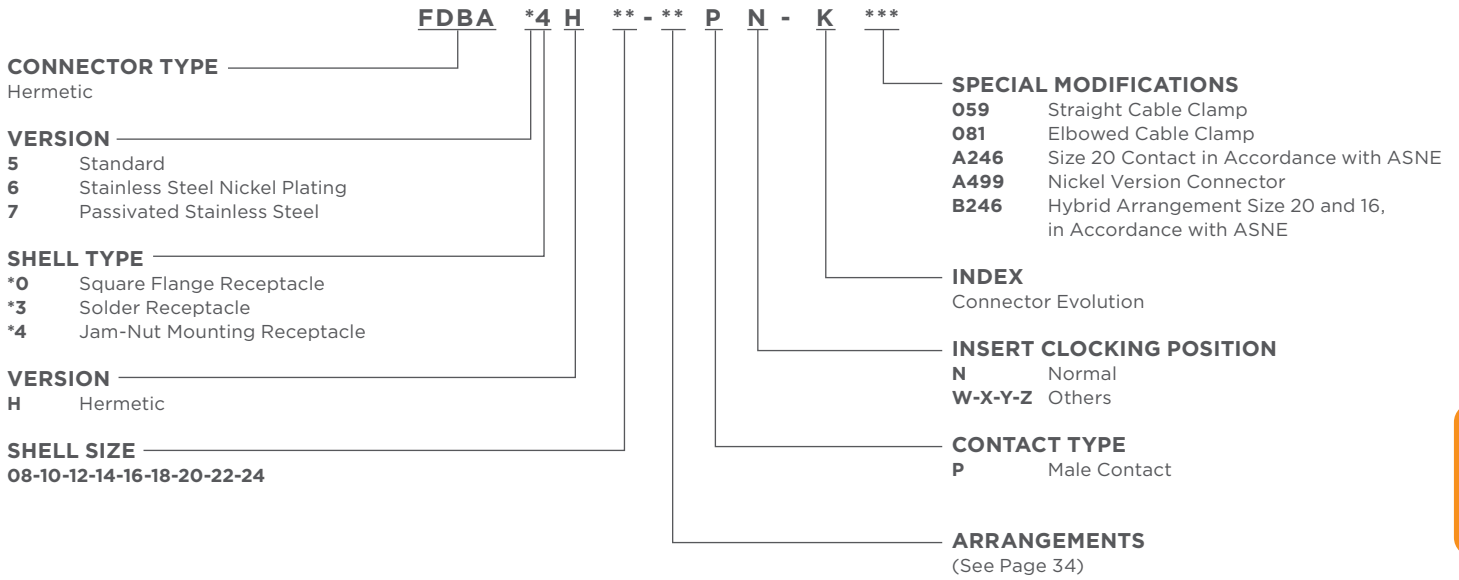

EN3646 Part Numbering

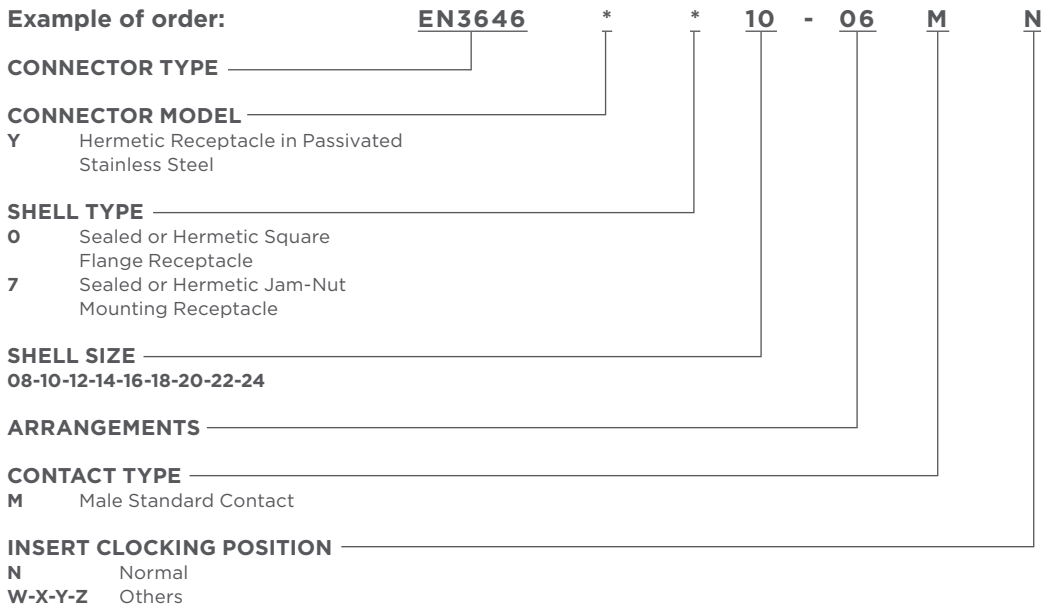

Key Orientation

Male Front Face View

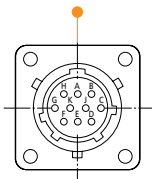

Normal Clocking Position

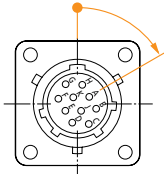

Clockwise Position

Clocking position is normal when the insert vertical axis is intermingled with the shell keyway axis. An unkeying can be performed between 2 connectors of same layout by angular displacement of one of the inserts in its shell.

This insert rotation is made in the clockwise for pin layouts and in the counter clockwise for socket layouts. Angular displacements on the hereafter table give clocking positions W - X - Y - or Z (see table).

Arrangements	Clocking Position in Degrees				Contacts Sizes				Service Voltage (see page 7)
	W	X	Y	Z	20	16	12	8	
8-3A / 8-98	60	210	—	—	3	—	—	—	1
8-33	90	—	—	—	3	—	—	—	1
8 E1*	—	—	—	—	—	—	—	1	—
10-6	90	—	—	—	6	—	—	—	1
12-3	—	—	180	—	—	3	—	—	2
12-8	90	112	203	292	8	—	—	—	1
12-10	60	155	270	295	10	—	—	—	1
14-4	45	—	—	—	—	—	4	—	1
14-5	40	92	184	273	—	5	—	—	2
14-12	43	90	—	—	8	4	—	—	1
14-15	17	110	155	234	14	1	—	—	1
14-19	30	165	315	—	19	—	—	—	1
16-8	54	152	180	331	—	8	—	—	2
16-21	—	—	—	—	16	5	—	—	1
16-26	60	—	275	338	26	—	—	—	1
18-11	62	119	241	340	—	11	—	—	1
18-32	85	138	222	265	32	—	—	—	1
20-16	238	318	333	347	—	16	—	—	2
20-39	63	144	252	333	37	2	—	—	1
20-41	45	126	225	—	41	—	—	—	1
22-12	—	—	—	6	—	—	12	—	1
22-21	16	135	175	349	—	21	—	—	2
22-41	39	135	264	—	27	14	—	—	1
22-55	30	142	226	314	55	—	—	—	1
24-19	30	165	315	—	—	—	19	—	2
24-31	90	225	255	—	—	31	—	—	1
24-61	90	180	270	324	61	—	—	—	1

* 8 E1 arrangement used only with coax, twinax, triax, quadax, and optical contacts

Hermetic Receptacles

Square Flange

FDBA 50H

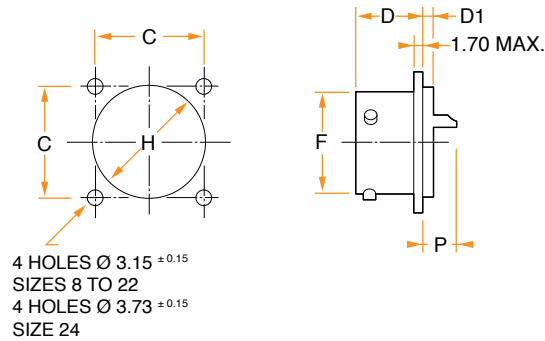

FDBA 50H**-A276A

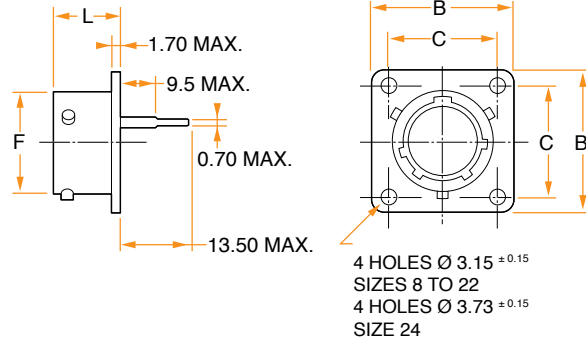

FDBA 53H

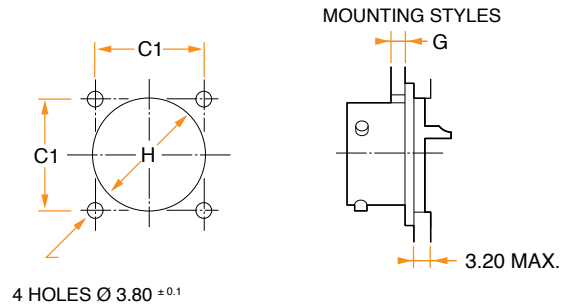

FDBA 53H**-A276A

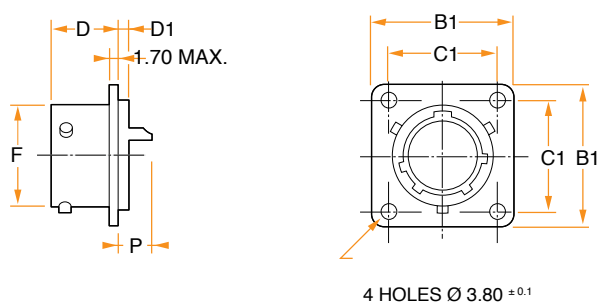

Size	08	10	12	14	16	18	20	22	24
B max.	21.00	24.25	26.60	29.00	31.30	33.70	36.85	39.95	43.15
B1 max.	26.50	29.10	32.25	34.65	37.00	39.05	43.00	44.95	48.15
C ± 0.1	15.08	18.26	20.62	23.02	24.58	26.98	29.36	31.76	34.92
C1 ± 0.1	18.10	20.62	23.82	26.18	28.57	30.55	32.94	34.92	38.10
D ± 0.15	12.65	12.65	12.62	12.65	12.65	12.65	14.09	14.09	14.93
D1 max.	1.55	1.55	1.55	1.55	1.55	1.55	2.25	2.25	2.25
F max.	12.03	15.01	19.07	22.24	25.42	28.60	31.77	34.94	38.12
G max.	2.50	2.50	2.50	2.50	2.50	2.50	5.40	5.40	5.40
H +0 / -0.2	16.05	19.00	22.25	25.40	28.60	31.75	34.90	38.10	41.30
L max.	13.75	13.75	13.75	13.75	13.75	13.75	15.35	15.35	15.35
P max. Sizes	20	6.85	6.85	6.85	6.85	6.85	7.10	7.10	6.25
	16	8.95	8.95	8.95	8.95	8.95	9.20	9.20	8.35

Dimensions in mm

Hermetic Receptacles

Single Hole Mounting

FDBA 54H

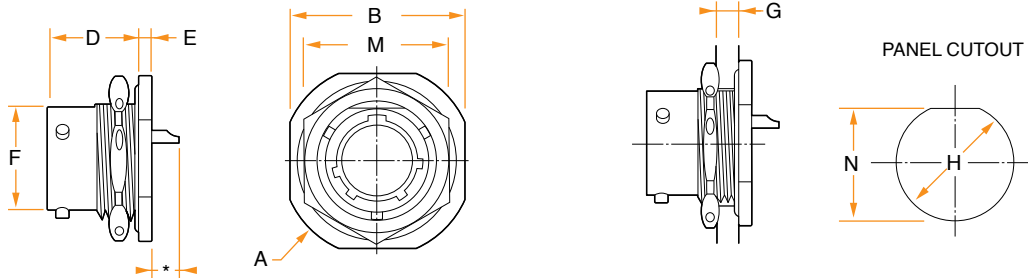

- * THE CONTACTS SIZE 20 ARE SUNK IN THE SHELL.
- * THE CONTACTS SIZE 16 CAN STICK OUT OF 1.35 MAX.

FDBA

Size	08	10	12	14	16	18	20	22	24
A max.	27.30	30.50	35.30	38.40	41.60	44.80	49.60	52.70	55.90
B max.	24.00	27.20	32.00	35.10	38.30	41.50	46.20	49.40	52.60
D ± 0.15	17.81	17.81	17.81	17.81	17.81	17.81	22.58	22.58	23.67
E max.	2.50	2.50	2.50	2.50	2.50	2.50	3.30	3.30	3.30
F max.	12.03	15.01	19.07	22.24	25.42	28.60	31.77	34.94	38.12
G max.	3.17	3.17	3.17	3.17	3.17	3.17	6.35	6.35	6.35
H +0.2 / -0	14.40	17.58	22.45	25.52	28.70	31.87	35.05	38.22	41.40
M max.	19.20	22.37	27.12	30.30	33.47	36.67	39.82	43.02	46.17
N +0.2 / -0	13.48	16.66	20.80	23.95	27.10	30.27	33.45	36.62	39.80
Max. lightened nut jam nut mounting tightening torque	0.75 daN	1 daN	1.30 daN	1.50 daN	1.80 daN	2.10 daN	2.30 daN	2.60 daN	2.90 daN

Dimensions in mm

EN3646 / FDBA Series

Solder Flange

FDBA 53H

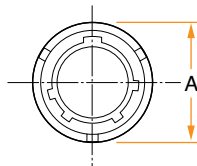
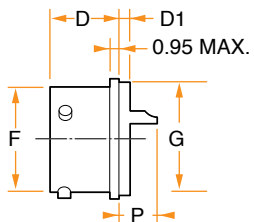

MOUNTING STYLES

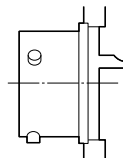

PANEL CUTOUT

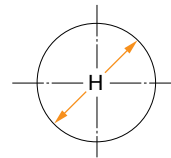

Size	08	10	12	14	16	18	20	22	24	
A max.	16.10	19.25	21.65	24.85	28.00	31.15	33.55	36.70	39.90	
D ± 0.5	11.50	11.50	11.50	11.50	11.50	11.50	13.11	13.11	13.95	
D1 max.	2.60	2.60	2.60	2.60	2.60	2.60	3.35	3.35	3.35	
F max.	12.03	15.01	19.07	22.24	25.42	28.60	31.77	34.94	38.12	
G max.	14.35	17.15	19.90	23.10	26.25	29.45	31.80	35.00	38.15	
H +0.2 / -0	14.75	17.55	20.30	23.50	26.65	29.85	32.20	35.40	38.55	
P max. Sizes	20	7.95	7.95	7.95	7.95	7.95	7.95	8.20	8.20	7.35
	16	10.00	10.00	10.00	10.00	10.00	10.00	10.30	10.30	9.50

Dimensions in mm

EN2997/983 Series



HIGH RELIABILITY

- Self-locking system

APPLICATION-MATCHED VERSIONS

- Hermetic stainless steel
- Hermetic aluminum

HERMETIC ALUMINUM IMPROVED PERFORMANCES

- Aluminum shell (weight savings)
- Nickel plated shells (better continuity)
- Copper alloy contacts (higher intensity)
- Glass-to-metal sealing

LARGE ACCESSORIES RANGE

- Backnut
- Straight cable clamp
- 90° cable clamp
- Custom design

HARSH ENVIRONMENT RESISTANCE

- High temperature operating (260°C)
- Fireproof inserts (thermoset and fluorinated silicon)
- Fluid resistant inserts

TE Connectivity's (TE) DEUTSCH 983 series connector was created in the 90's. This connector has been especially designed for harsh environment aircraft zone applications such as engines and boosters.

Available in two versions, TE's DEUTSCH 983 series connector is used in its stainless steel version on harsh constraint-facing areas such as engines, landing gears, APU (Auxiliary Power Unit), wings, pylons, leading edges whereas the aluminum version is used in cargo compartments.

Qualified to EN2997 specification for its stainless steel and aluminum version, TE's DEUTSCH 983 series is also qualified to ADS (Aerospace Defense and Security) ESC10, Boeing BACC63 and Airbus ABS specifications. In addition, TE's DEUTSCH 983 series is fully intermateable with MIL-DTL-83723 Series III connectors. TE's DEUTSCH 983 series connector uses contacts qualified to the EN3155 and ADS ESC30 specifications.

TE's DEUTSCH 983 Series connectors are distinguishable from MIL-DTL-83723 connectors by following improvements:

- Shell-to-shell metal bottoming (plug and receptacle mated)
- Anti-rotation system on 360° by tightening
- Self-locking system all plug
- Reduced elastomer barriers to use new and old generations of wires

All TE's DEUTSCH 983 electrical connectors series are intermateable and interchangeable with connectors in accordance with MIL-DTL-83723 series III.

A large accessories range completes TE's DEUTSCH 983 connector series:

- Backnut
- Straight cable clamp
- 90° cable clamp

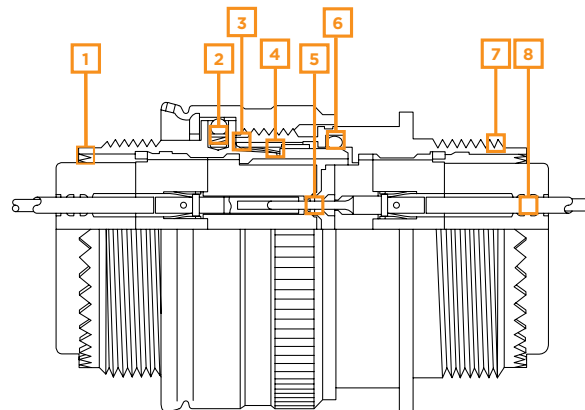

- | | |
|---|---|
| <ol style="list-style-type: none"> 1 Connector's rear part fitted with a teeth anti-rotation system (360°) assuring an effective tightening and clamping of accessories / EMI shielding improvement 2 Self locking control 3 Shell to shell metal bottoming 4 RFI grounding fingers for electrical continuity between plug and receptacle | <ol style="list-style-type: none"> 5 Individual contact sealing at coupling stage by compression of elastomer conical risers on hard insert 6 Interface sealing assumed by High Frequency (H.F.) gasket 7 Shell/insert assumed by potting 8 Sealing on each wire thanks to several sealing barriers |
|---|---|

EN2997/983 Series

ENVIRONMENTAL

- **Temperature Range:**
Class Y: -65°C to 200°C
Class YE: -65°C to 260°C
- **Durability:** 500 mating cycles
- **Salt Spray:** 500 hours
- **Vibration:** 10 to 2000 Hz, 3 axes (EN2591-403, method B)
- **Shock:** 300 g/3 ms (EN2591-402)

MECHANICAL

- **Shell Material:** Stainless steel
- **Insert Material:** Sintered glass
- **Contacts:** Solder type, non-removable, gold plated
- **Temperature Range:**
-65°C to +200°C
-65°C to +260°C cyclic
- **Mechanical Endurance:** 500 operations
- **Corrosion (Salt Spray) as per EN2591-307:** 500 hours
- **Vibrations as per EN2591-403, Method B:** 10 to 2000 Hz along 2 axes
- **Shock as per EN2591-402:** 300 g/3ms
- **Hermeticity:** 0.36 mm³/h (as per EN2591-322)

ELECTRICAL

- **Insulation Resistance**
At +25°C and 65% R.H: > 5000 MΩ
At +260°C and 65% R.H: > 1000 MΩ
- **Dielectric Withstanding Voltage**
At Sea Level: 1500 V_{rms} 50 Hz mated connectors
At 15,000 meters altitude: 1000 V_{rms} 50 Hz mated connectors
At 30,000 meters altitude: 200 V_{rms} 50 Hz mated connectors
- **Shielding Efficiency as per EN2591-213**
100 MHz to 1 GHz Models RS - WS - S - SE - SV - SF

Arrangements

Male Insert: Front Face View



08-03
3 Size 20
Contacts ▲



08-06
6 Size 22
Contacts ▲



08-98
3 Size 20
Contacts



10-05
5 Size 20
Contacts



10-06
6 Size 20
Contacts



10-12
12 Size 22
Contacts ▲



12-03
3 Size 16
Contacts



12-12
12 Size 20
Contacts ▲



12-21
21 Size 22
Contacts ▲



14-04
4 Size 12
Contacts

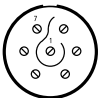

14-07
7 Size 16
Contacts

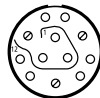

14-12
9 Size 20 Contacts
3 Size 16 Contacts

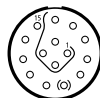

14-15
15 Size 20
Contacts

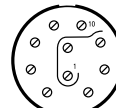

16-10
10 Size 16
Contacts

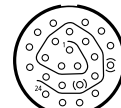

16-24
24 Size 20
Contacts

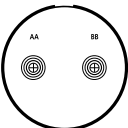

18-02
2 Size K6
Contacts * □

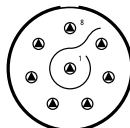

18-08
8 Size 12
Contacts

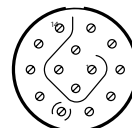

18-14
14 Size 16
Contacts

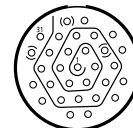

18-31
31 Size 20
Contacts

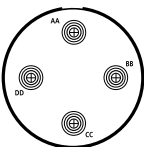

20-04
4 Size K6
Contacts □

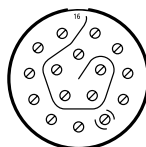

20-16
16 Size 16
Contacts *

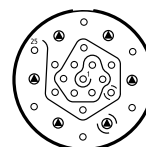

20-25
19 Size 20 Contacts
6 Size 12 Contacts

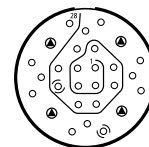

20-28
24 Size 20 Contacts
4 Size 12 Contacts

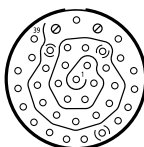

20-39
37 Size 20 Contacts
2 Size 16 Contacts

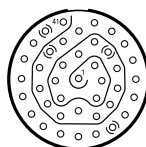

20-41
41 Size 20 Contacts

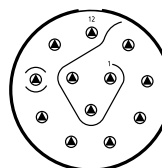

22-12
12 Size 12 Contacts

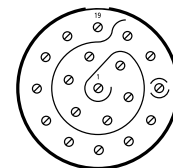

22-19
19 Size 16 Contacts

▲ Aluminum, please consult TE Technical Support

* Consult TE Technical Support

□ Aluminum, please consult TE Technical Support

Arrangements

Male Insert: Front Face View

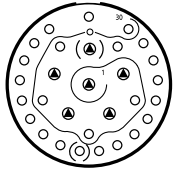

22-30
24 Size 20 Contacts
6 Size 12 Contacts *

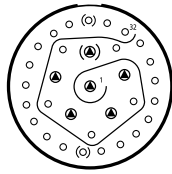

22-32
26 Size 20 Contacts
6 Size 12 Contacts *

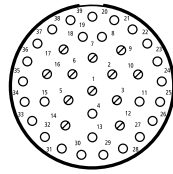

22-39
27 Size 20 Contacts
12 Size 16 Contacts *

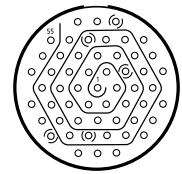

22-55
55 Size 20
Contacts

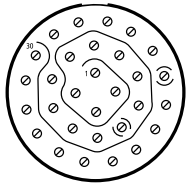

24-30
30 Size 16
Contacts *

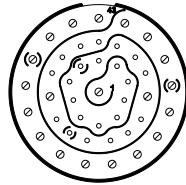

24-43
23 Size 20 Contacts
20 Size 16 Contacts *

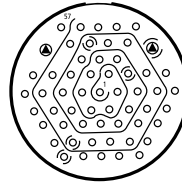

24-57
55 Size 20 Contacts
2 Size 12 Contacts *

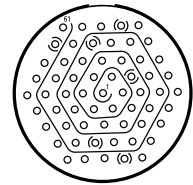

24-61
61 Size 20
Contacts

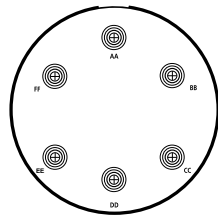

28-06
6 Size K6
Contacts *

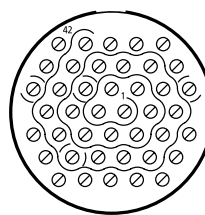

28-42
42 Size 16
Contacts *

▲ Aluminum, please consult TE Technical Support

* Consult TE Technical Support

▲ Aluminum, please consult TE Technical Support

EN2997/983 Series

DEUTSCH Part Numbering

Example of order: 983-1YE 22-55 PN

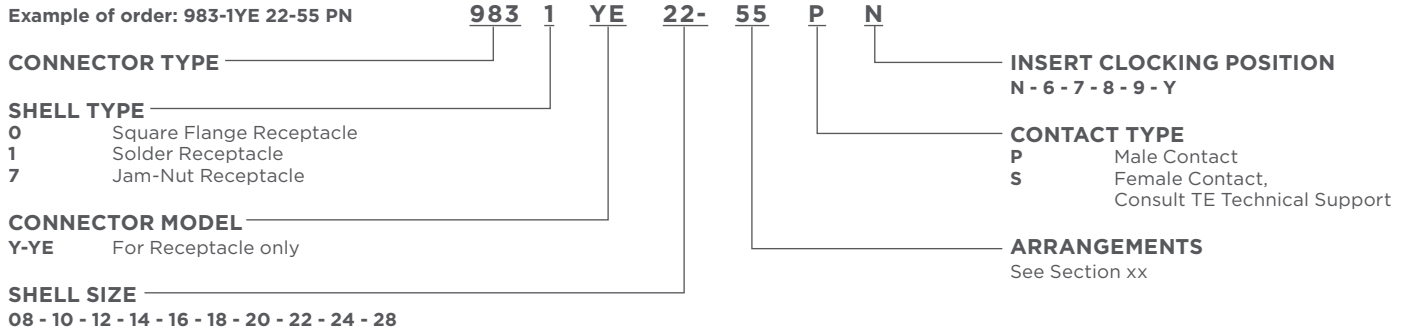

No aluminum hermetic according to EN2997 and ESC10 specifications.
 For any inquiry concerning aluminum hermetics, please consult TE Technical Support.

ASD-STAN Part Numbering

Example of order: EN2997YE12255MN

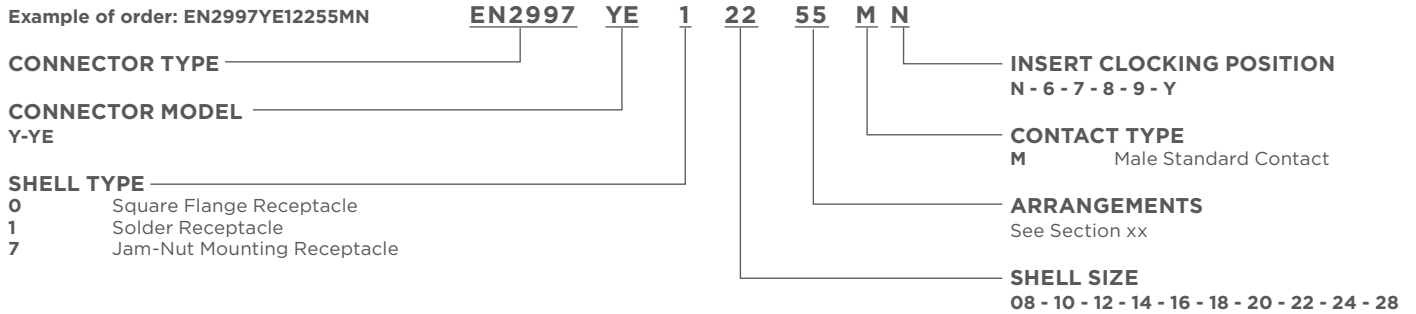

ESC10 Part Numbering

Example of order: ESC10YE12255NO

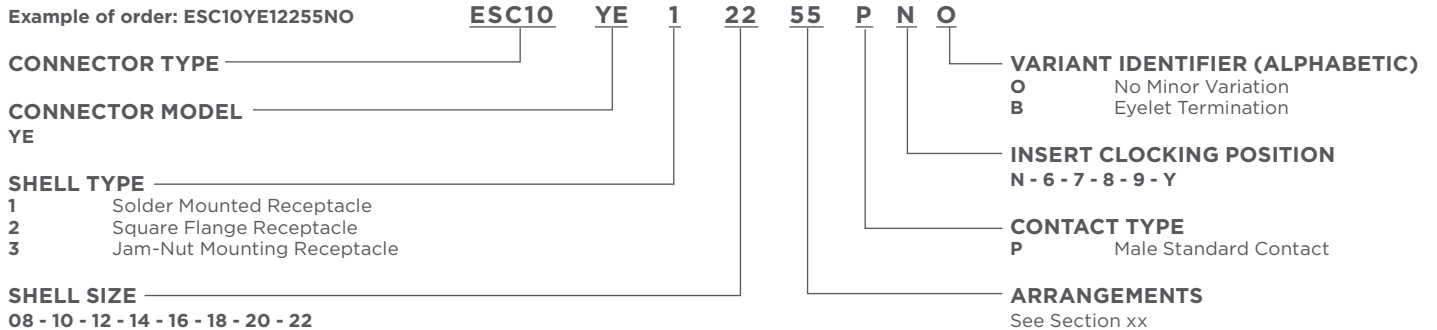

EN2997/983 Series

Plug Front View

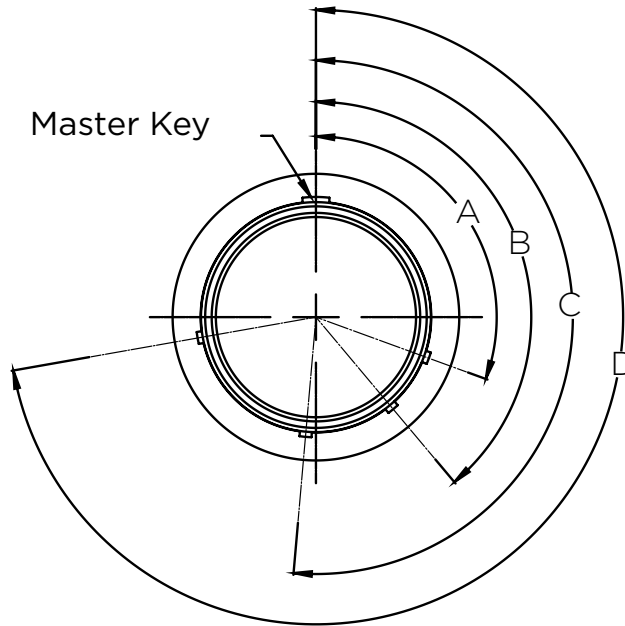

Keying Position	Key/Keyway locations in degrees											
	Size 8				Size 10				Size 12 to 28			
	A°	B°	C°	D°	A°	B°	C°	D°	A°	B°	C°	D°
N-Normal	105	140	215	265	105	140	215	265	105	140	215	265
6	102	132	248	320	102	132	248	320	18	149	192	259
7	80	118	230	312	80	118	230	312	92	152	222	342
8	35	140	205	275	35	140	205	275	84	152	204	334
9	64	155	234	304	64	155	234	304	24	135	199	240
Y	—	—	—	—	25	115	220	270	98	152	268	338

Keying Position	Key/Keyway locations in degrees for T and V polarizations (230V only)							
	Size 12 and 14				Size 20			
	A°	B°	C°	D°	A°	B°	C°	D°
T	55	145	228	280	45	160	210	300
V	50	156	218	290	60	165	235	285

Note: Keying positions T and V do not apply to shell sizes 08, 10, 16, 18, 22, 24 and 28.

EN2997/983 Series

Receptacle Square Flange

Type O

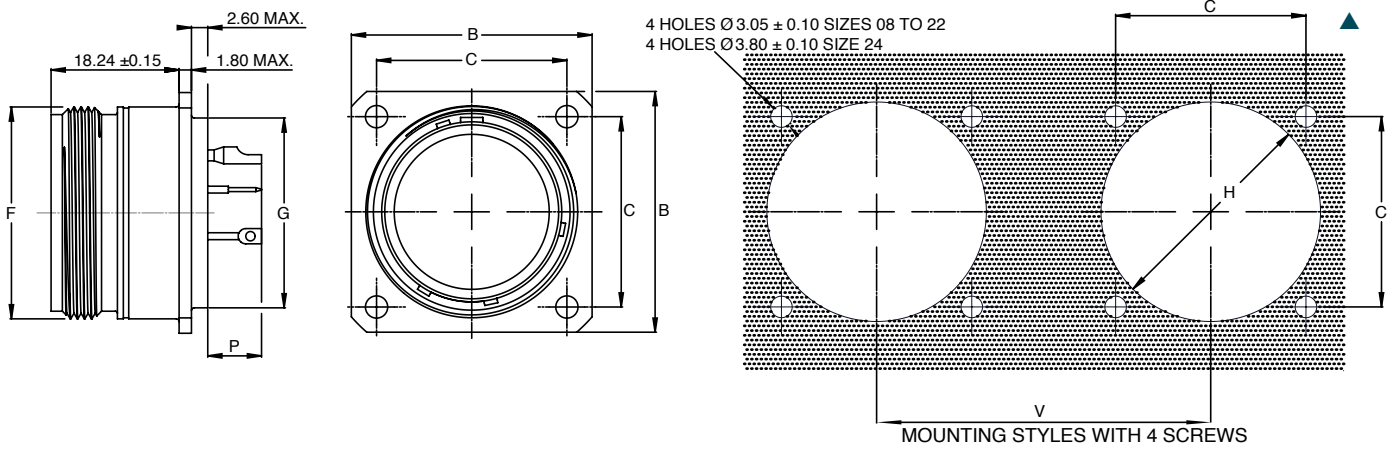

Size	B Max.	C ± 0.05	F Max.	G Max.	H Min.	P Max Size		V Min.	Weight Max. (g) Stainless Steel
						20	16-12		
08	20.75	15.09	14.27	12.70	15.80	4.93	5.69	31.70	18
10	23.93	18.26	17.67	14.27	18.70	4.93	5.69	34.90	24
12	26.32	20.62	22.22	19.05	23.40	4.93	5.69	39.60	31
14	28.71	23.01	23.77	20.62	24.90	4.93	5.69	41.25	40
16	31.88	24.61	26.97	23.80	28.30	4.93	5.69	44.45	49
18	34.24	26.97	30.15	26.97	31.10	4.93	5.69	47.35	54
20	36.63	29.36	33.32	30.18	34.50	4.93	5.69	51.90	62
22	39.80	31.75	36.49	33.32	37.50	4.93	5.69	54.10	77
24	43.39	34.92	39.67	36.53	40.60	4.93	5.69	57.25	88

Dimensions in mm



Overall dimensions and characteristics are given for indication guidance only. TE Connectivity reserves the right to modify them for production improvement reasons (Proprietary products only).

EN2997/983 Series

Receptacle Jam-Nut Mounting

Type 7

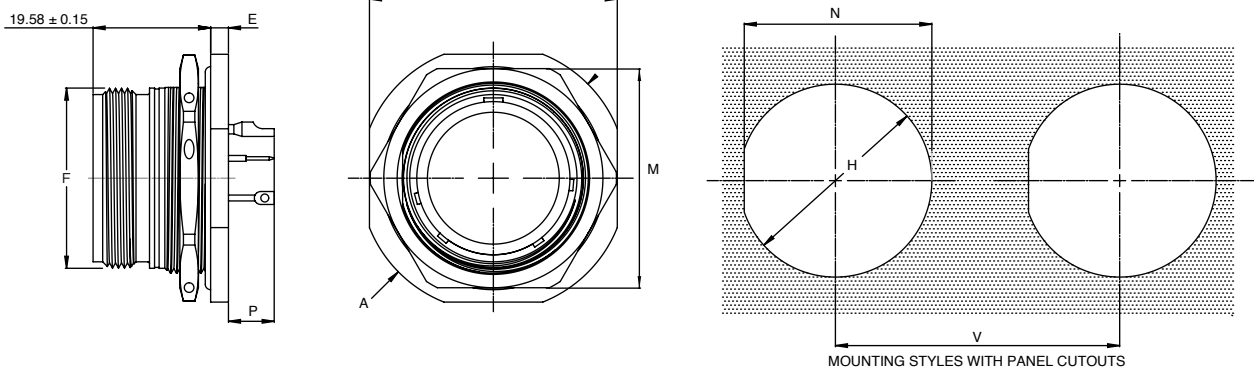

Size	A Max.	B Max.	E Max.	F Max.	H Min.	M Max.	N 0-0.26	P Max Size		V Min.	Weight Max. (g) Stainless Steel	Tightening Torque of Panel Nut
								20	16-12			
08	27.38	24.89	3.48	14.27	16.26	21.06	15.50	4.57	5.33	31.70	29	7 m.N max.
10	30.28	28.04	3.48	17.67	19.43	24.23	18.67	4.57	5.33	34.90	37	10 m.N max.
12	35.05	32.79	3.48	22.22	24.18	29.01	23.42	4.57	5.33	39.60	50	12 m.N max.
14	38.51	35.33	3.48	23.77	25.78	30.61	25.02	4.57	5.33	41.25	58	15 m.N max.
16	41.68	38.51	3.48	26.97	28.96	33.76	28.20	4.57	5.33	44.45	72	18 m.N max.
18	44.86	41.68	3.48	30.15	32.13	36.96	31.25	4.57	5.33	47.35	79	22 m.N max.
20	49.63	44.86	3.48	33.32	35.31	40.11	34.42	4.57	5.33	51.90	87	25 m.N max.
22	52.78	49.63	3.76	36.49	38.48	43.31	37.59	4.29	5.05	54.10	108	27 m.N max.
24	55.42	52.81	3.76	39.67	41.66	46.46	40.77	4.29	5.05	57.25	122	29 m.N max.

Dimensions in mm

Receptacle Solder Round Flange

Type 1

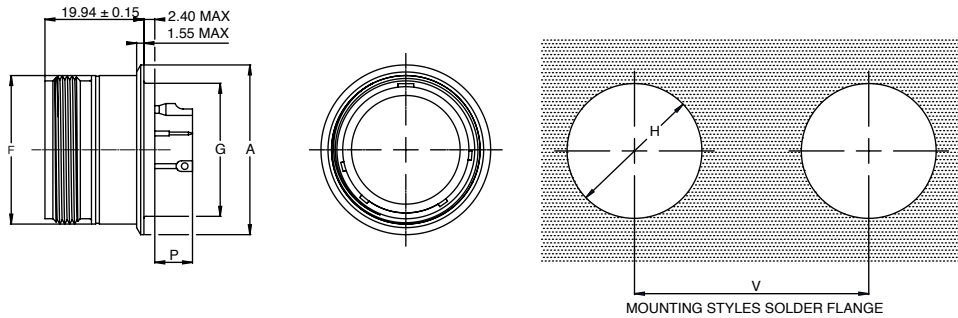

Size	A ± 0-0.2	F Max.	G Max.	H Min.	P Max Size		V Min.	Weight Max. (g)
					20	16-12		
08	18.36 / 17.86	14.27	12.70	12.96	4.93	5.69	31.70	15
10	21.59 / 21.08	17.67	14.27	14.53	4.93	5.69	34.90	21
12	26.80 / 26.29	22.22	19.05	19.30	4.93	5.69	39.60	31
14	27.94 / 27.43	23.77	20.62	20.88	4.93	5.69	41.25	35
16	30.99 / 30.48	26.97	23.80	24.05	4.93	5.69	44.45	46
18	34.39 / 33.78	30.15	26.97	27.23	4.93	5.69	47.35	51
20	37.34 / 36.83	33.32	30.15	30.40	4.93	5.69	51.90	59
22	40.64 / 40.13	36.49	33.32	33.58	4.93	5.69	54.10	73
24	43.68 / 43.17	39.67	36.50	36.75	4.93	5.69	57.25	86

Dimensions in mm

Stainless Steel shell exempt of sulphur to help withstand Electron Beam (E.B.) welding and laser.

Overall dimensions and characteristics are given for indication guidance only. TE Connectivity reserves the right to modify them for production improvement reasons (Proprietary products only).

MIL-DTL-26482 Series I Connectors

Hermetic receptacles with full glass inserts



TE Connectivity (TE)'s DEUTSCH DTK hermetic receptacles are compatible with the 26482 standard and provide true hermetic sealing against deteriorating environmental forces. The precision molded insert offers continuous dielectric separation and higher voltage ratings than connectors with individual contact insulators. They are suitable for a wide range of applications and environments that require equipment to be isolated from variations in atmospheric pressure.

RELIABLE

- Service-proven bayonet coupling and lock

EASY TO USE

- Mates with existing MS3116 plugs and features color-keyed index grooves for positive alignment engagement
- Shell sizes from 8 to 24
- Lock indicators assure reliable visual and blind coupling lock inspection

DURABLE

- Single compression glass insert insures a leakproof seal

CUSTOM OPTIONS

- Available with socket contacts in resilient silicone insert front

ENVIRONMENTAL

- **Temperature Range:** -55°C to +200°C
- **Thermal Shock:** No deterioration or failure after 5 cycles at -73°C to +200°C

MECHANICAL

- **Shell:**
Material - C1215 Mild steel, **Insulator** - Glass insert
Contact - 52 High nickel-iron alloy, **O-Ring** - Silicone
- **Finish (Shell and Contact):** Tin over nickel
- **Insert Material:** Compression glass
- **Usable Wire Size:** 12 to 24 gauge, depending on number and size of contacts
- **Glass Strength:** Withstands pressure differentials of 1000 lb/in² without loss of electrical quality or leakage

ELECTRICAL

- **Dielectric with Standing Voltage:**
At Sea Level: 1500 Volts (RMS) 60 Hz, 2100 Volts DC
- **Current Rating:**
 7.4 amps - #20 contacts
 20 amps - #16 contacts
 25 amps - #12 contacts
- **Insulation Resistance:** ≥ 5000 MΩ
- **Air Leakage:** 1.10⁻⁶ mbar.l.s-1 under 1 bar vacuum or 0.36 mm³/h (as per EN2591-322)

Part Numbering

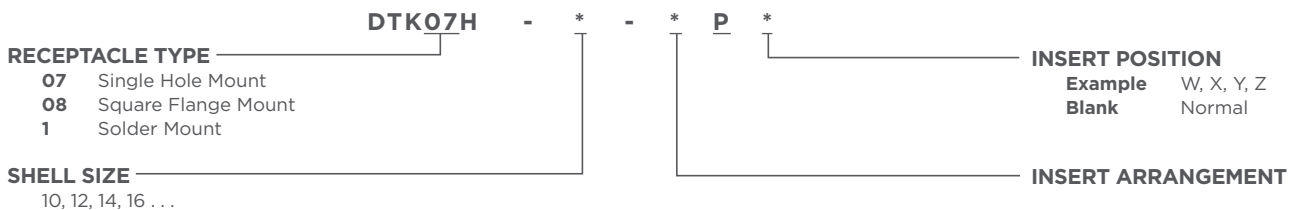

MIL-DTL-26482 Series I Connectors

Hermetic Pin Unit, Single Hole Mount

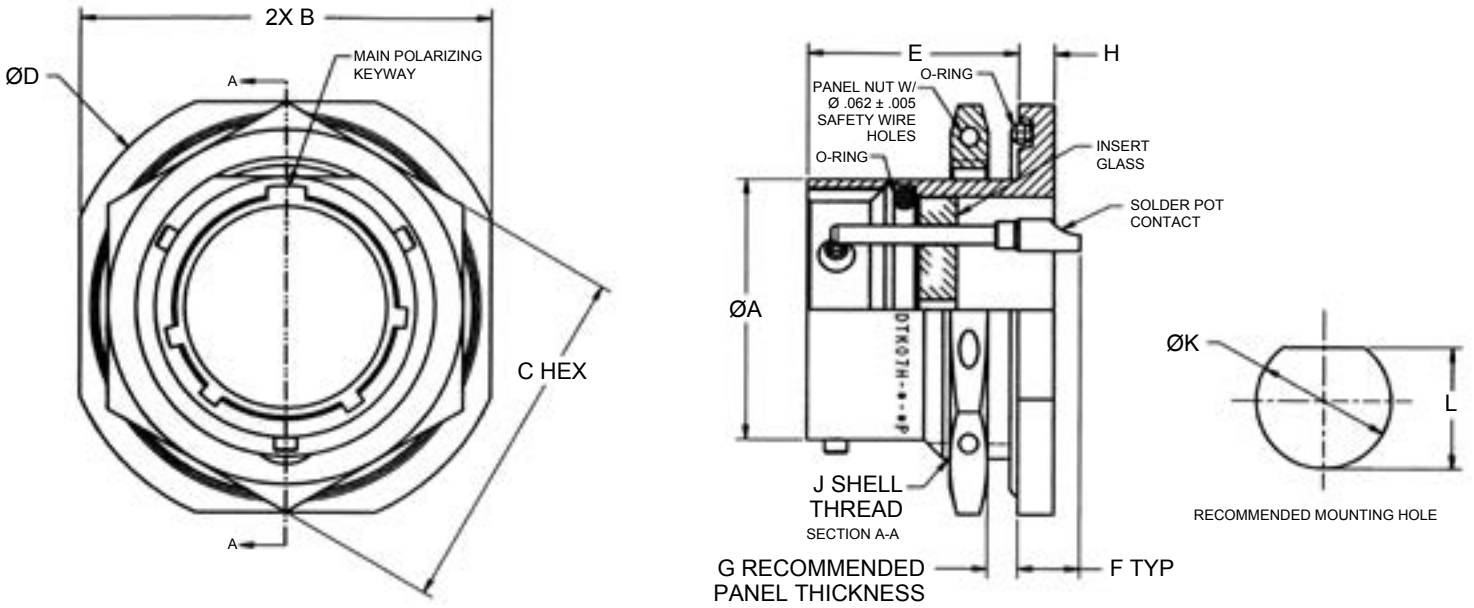

Part Number	A + .001 - .005	B ± .016	C ± .016	D Max	E + .031 - .000	F Max	G Panel Thk.		H ± .015	J Thread Class 2A	K + .010 - .000	L + .000 - .010	Weight (Lb)
							Min	Max					
DTK07H-08--P	.473	.983	.750	1.078	.691	.129	.062	.125	.094	.5625-24UNEF	.572	.542	.042
DTK07H-10--P	.590	1.062	.875	1.203	.691	.129	.062	.125	.094	.6875-24UNEF	.697	.669	.054
DTK07H-12--P	.750	1.250	1.062	1.391	.691	.129	.062	.125	.094	.8750-20UNEF	.884	.830	.080
DTK07H-14--P	.875	1.375	1.188	1.516	.691	.129	.062	.125	.094	1.000-20UNEF	1.007	.955	.097
DTK07H-16--P	1.000	1.500	1.312	1.641	.691	.129	.062	.125	.094	1.1250-18UNEF	1.134	1.084	.110
DTK07H-18--P	1.125	1.625	1.438	1.766	.691	.129	.062	.125	.094	1.2500-18UNEF	1.259	1.208	.137
DTK07H-20--P	1.250	1.812	1.562	1.959	.879	.035	.062	.250	.125	1.3750-18UNEF	1.384	1.333	.191
DTK07H-22--P	1.375	1.938	1.688	2.078	.879	.035	.062	.250	.125	1.5000-18UNEF	1.507	1.459	.217
DTK07H-24--P	1.500	2.062	1.812	2.203	.912	.046	.062	.250	.125	1.6250-18UNEF	1.634	1.575	.240

Dimensions in inches

MIL-DTL-26482 Series I Connectors

Hermetic Pin Unit, Square Flange Mount

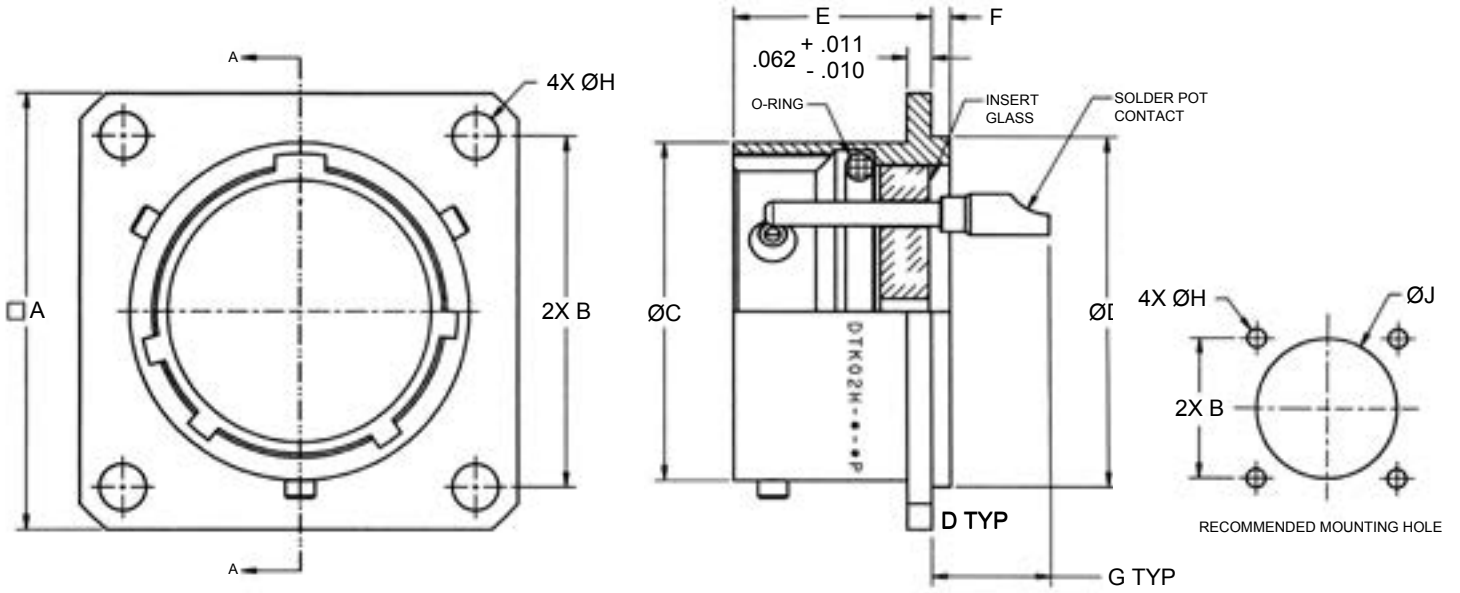

Part Number	A ± .016	B ± .005	C + .001 - .005	D + .001 - .005	E + .026 - .005	F ± .016	G Max	H ± .005	J + .010 - .000	Weight (Lb)
DTK02H-08→P	.812	.594	.473	.562	.494	.047	.344	.120	.572	.025
DTK02H-10→P	.938	.719	.590	.672	.494	.047	.344	.120	.682	.035
DTK02H-12→P	1.031	.812	.750	.781	.494	.047	.344	.120	.791	.037
DTK02H-14→P	1.125	.906	.875	.906	.494	.047	.344	.120	.916	.047
DTK02H-16→P	1.219	.969	1.000	1.031	.494	.047	.344	.120	1.041	.053
DTK02H-18→P	1.312	1.062	1.125	1.156	.494	.047	.344	.120	1.166	.069
DTK02H-20→P	1.438	1.156	1.250	1.250	.556	.047	.344	.120	1.260	.084
DTK02H-22→P	1.562	1.250	1.375	1.375	.556	.079	.377	.120	1.385	.101
DTK02H-24→P	1.688	1.375	1.500	1.500	.588	.079	.377	.147	1.510	.142

Dimensions in inches

MIL-DTL-26482 Series I Connectors

Hermetic Pin Unit, Solder Mount

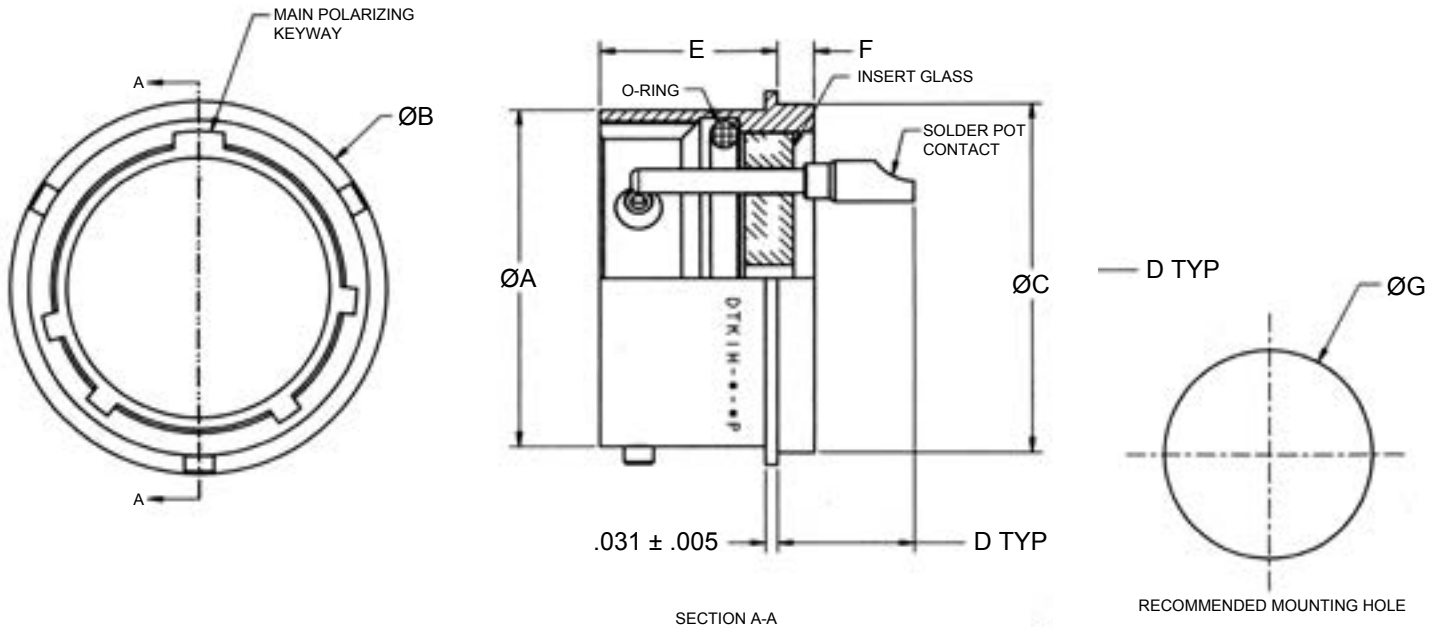

Part Number	A + .001 - .005	B Max	C + .001 - .005	D Max	E + .020 - .010	F ± .010	G + .010 - .000	Weight (Lb)
DTK1H-08-P	.473	.635	.562	.386	.447	.094	.572	.014
DTK1H-10-P	.590	.760	.672	.386	.447	.094	.682	.018
DTK1H-12-P	.750	.854	.781	.386	.447	.094	.791	.028
DTK1H-14-P	.875	.979	.906	.386	.447	.094	.916	.035
DTK1H-16-P	1.000	1.104	1.031	.386	.447	.094	1.041	.040
DTK1H-18-P	1.125	1.228	1.156	.386	.447	.094	1.166	.058
DTK1H-20-P	1.250	1.322	1.250	.386	.509	.094	1.260	.076
DTK1H-22-P	1.375	1.448	1.375	.418	.509	.125	1.385	.087
DTK1H-24-P	1.500	1.574	1.500	.418	.542	.125	1.510	.129

Dimensions in inches

MIL-C-26482 Series 2 Hermetic Receptacles

High performance metal shelled DBC hermetic receptacles, qualified to MIL-C-26482 Series 2



TE Connectivity (TE)'s DEUTSCH DTS series intermates with all qualified Series 2 plugs. Qualified receptacles feature DEUTSCH developed direct glass-to-metal sealing and solder pot or eyelet terminated pin type contacts. TE also offers special application receptacles, including socket type contacts, total and patterned bussed contacts and contacts to terminate flex tape and printed circuit boards. Consult TE regarding availability.

COMPATIBLE

- Intermateable with all qualified Series 2 plugs
- Qualified to MIL-C-26482 Series 2

DURABLE

- Direct glass-to-metal sealing ensures a leakproof seal

CUSTOM OPTIONS

- Solder pot or eyelet terminated pin type contacts

ENVIRONMENTAL

- **Temperature Range:** -67°F to +392°F
- **Vibration:** Exceeds requirements of MIL-STD-1344, method 2005 per MIL-C-26482
- **Physical Shock:** No unlocking or electrical discontinuity when tested per MIL-STD-1344, method 2004 at half sine wave of 300 gs
- **Air Leakage:** Less than 0.1 micron cu. ft./hr. at 15 psi differential per MIL-C-26482 and MIL-STD-2002, method 112, condition C, procedure 1
- **Durability:** 500 cycles of engagement per MIL-C-26482
- **Moisture Resistance:** Meets requirements of MIL-C-26482
- **Corrosion:** Exceeds requirements of MIL-STD-1344 method 1001 per Mil-C-26482 using standard plating

ELECTRICAL

- **Dielectric Withstanding Voltage at Sea Level:**
 - #20 Contacts: 1500 V AC rms @ 60Hz
 - #16 Contacts: 2300 V AC rms @ 60Hz
 - #12 Contacts: 2300 V AC rms @ 60Hz
- **Current Rating:**
 - #20 Contacts: 7.5 amps
 - #16 Contacts: 25 amps
 - #12 Contacts: 40 amps
- **Contact Resistance:**
 - #20: 60 mV @ 5 amps
 - #16: 85 mV @ 10 amps
 - #12: 85 mV @ 17 amps
- **Insulation Resistance:** 5000 Meg ohms min @ 75°F per MIL-C-26482
- **Thermal Shock:** No deterioration or failure after 5 cycles @ -67°F to +392°F

STANDARDS AND SPECIFICATIONS

- Qualified to MIL-C-26482

MIL-DTL-26482 Series II Receptacle Connectors

DEUTSCH Base Part No.	Mil Cross Type	Receptacle Mounting	Variations	
			Shell Materials	Contact Styles
DBC50H	MS3440H	Square Flange	Tin-Plated Steel	Solder Cup
DBC53H	MS3443H	Solder Flange		
DBC54H	MS3449H	Jam Nut		
DBA50H	MS3440H	Square Flange	Stainless Steel	Solder Cup
DBA53H	MS3443H	Solder Flange		
DBA54H	MS3449H	Jam Nut		

Arrangements

MIL-STD-1669 Insert Arrangements



8-4
4 Size 20
Contacts



8-98
3 Size 20
Contacts



8-33
3 Size 20
Contacts



10-6
6 Size 20
Contacts



12-3
3 Size 16
Contacts



12-8
8 Size 20
Contacts



12-10
10 Size 20
Contacts



14-4
4 Size 12
Contacts



14-5
5 Size 16
Contacts



14-12
8 Size 20 Contacts
4 Size 16 Contacts



14-15
14 Size 20 Contacts
1 Size 16 Contact

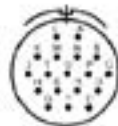

14-18
18 Size 20
Contacts

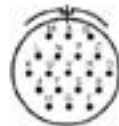

14-19
19 Size 20
Contacts



16-8
8 Size 16
Contacts

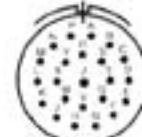

16-23
22 Size 20 Contacts
1 Size 16 Contact

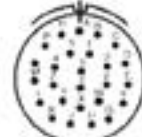

16-26
26 Size 20
Contacts



18-8
8 Size 12
Contacts

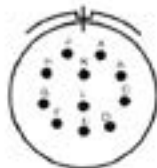

18-11
11 Size 16
Contacts

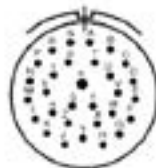

18-30
29 Size 20 Contacts
1 Size 16 Contact

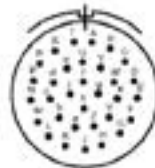

18-32
32 Size 20
Contacts

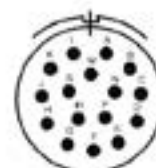

20-16
16 Size 16
Contacts

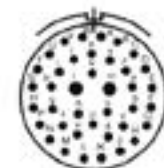

20-39
37 Size 20 Contacts
2 Size 16 Contacts

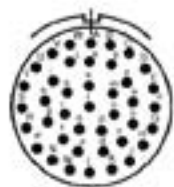

20-41
41 Size 20
Contacts

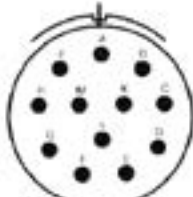

22-12
12 Size 12
Contacts

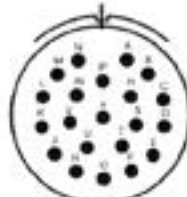

22-21
21 Size 16
Contacts

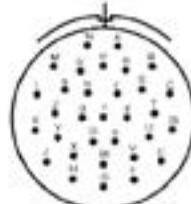

22-32
32 Size 20
Contacts

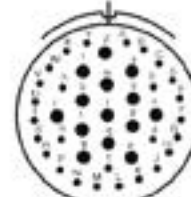

22-41
27 Size 20 Contacts
14 Size 16 Contacts

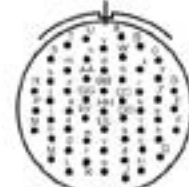

22-55
55 Size 20
Contacts

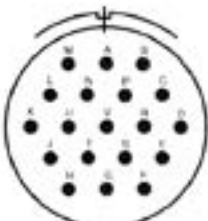

24-19
19 Size 12
Contacts

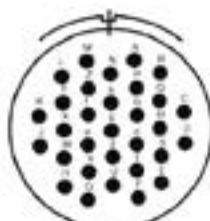

24-31
31 Size 16
Contacts

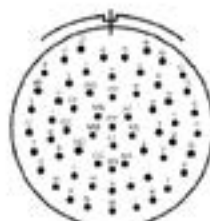

24-61
61 Size 20
Contacts

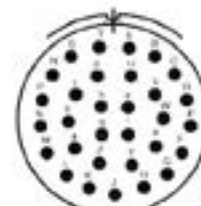

24-98
31 Size 16
Contacts

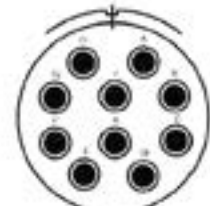

24-100*
10 Size 8
Coax Contacts

Insert arrangement shown front face of "pin" style receptacle
Consult TE for cable/contact selection

MIL-C-26482 Series 2 Hermetic Receptacles

Part Numbering

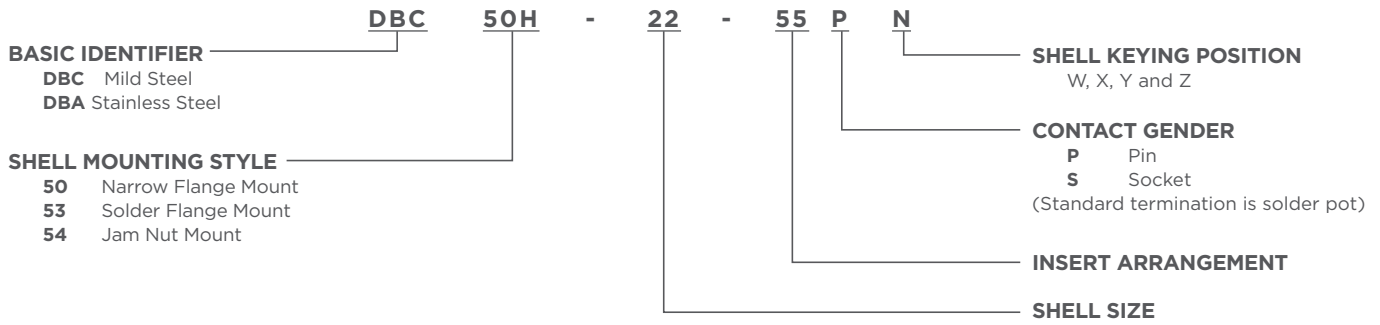

MIL-C-26482 Series 2 Hermetic Receptacles

Narrow Flange Mount - DBC50H or DBA50H

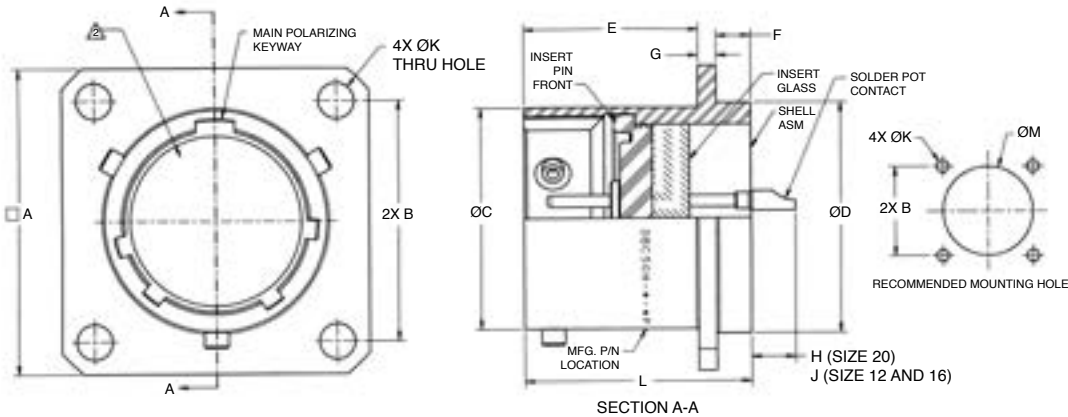

1. Dimensions are in inches unless otherwise specified
2. Insert arrangement per MIL-STD-1669
3. Mates with AFD56 - * - *S* plugs
4. Material:
Shell: Mild steel for DBC
 Stainless steel for DBA
Insulator: Glass insert
Contact: 52 high nickel/iron alloy
Insert pin front: fluorosilicone
5. Finish:
Shell: Tin over nickel plated for DBC
 Passivated stainless steel for DBA
Contact: Gold over nickel plate
6. Shell dimensions shown for pin unit only

Part Number	A Max	B ± .005	+0.001 C-.005	+0.001 D-.005	E ± .010	F ± .010	G ± .016	H ± .030	J ± .030	K ± .005	L Max Ref	+0.010 M-.000	Weight Max (lb)
DBC50H - 8 - *P*	.828	.594	.473	.562	.588	.115	.062	.148	.218	.120	.801	.572	.038
DBC50H - 10 - *P*	.954	.719	.590	.672	.588	.115	.062	.148	.218	.120	.801	.682	.044
DBC50H - 12 - *P*	1.047	.812	.750	.781	.588	.115	.062	.148	.218	.120	.801	.791	.052
DBC50H - 14 - *P*	1.141	.906	.875	.906	.588	.115	.062	.148	.218	.120	.801	.916	.070
DBC50H - 16 - *P*	1.234	.969	1.000	1.031	.588	.115	.062	.148	.218	.120	.801	1.041	.085
DBC50H - 18 - *P*	1.328	1.062	1.125	1.156	.588	.115	.062	.148	.218	.120	.801	1.166	.098
DBC50H - 20 - *P*	1.453	1.156	1.250	1.250	.650	.083	.093	.148	.218	.120	.863	1.260	.110
DBC50H - 22 - *P*	1.578	1.250	1.375	1.375	.650	.115	.093	.116	.186	.120	.895	1.385	.150
DBC50H - 24 - *P*	1.703	1.375	1.500	1.500	.650	.115	.093	.116	.186	.147	.895	1.510	.280

Solder Mount - DBC53H or DBA53H

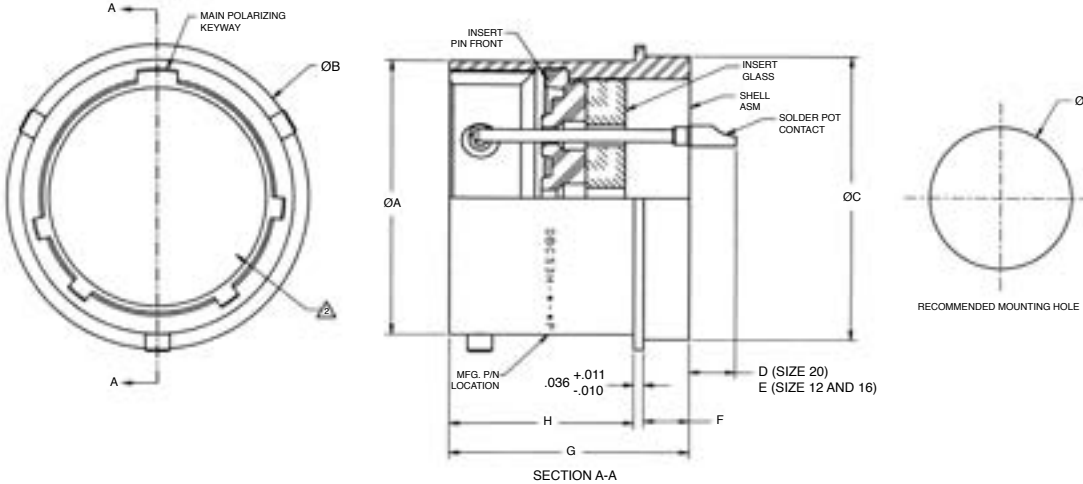

1. Dimensions are in inches unless otherwise specified
2. Insert arrangement per MIL-STD-1669
3. Mates with AFD56 - * - *S* plugs
4. Material:
Shell: Mild steel for DBC
 Stainless steel for DBA
Insulator: Glass insert
Contact: 52 high nickel/iron alloy
Insert pin front: fluorosilicone
5. Finish:
Shell: Tin over nickel plated for DBC
 Passivated stainless steel for DBA
Contact: Gold over nickel plate
6. Shell dimensions shown for pin unit only

Part Number	+0.001 N-.005	P ± .010	+0.001 R-.005	S ± .030	T ± .030	+0.000 U-.040	W Max Ref	X ± .010	+0.010 Y-.000	Weight Max (lb)
DBC53H - 8 - *P*	.473	.625	.562	.148	.218	.156	.801	.588	.570	.031
DBC53H - 10 - *P*	.590	.750	.672	.148	.218	.156	.801	.588	.680	.034
DBC53H - 12 - *P*	.750	.844	.781	.148	.218	.156	.801	.588	.789	.040
DBC53H - 14 - *P*	.875	.969	.906	.148	.218	.156	.801	.588	.914	.051
DBC53H - 16 - *P*	1.000	1.094	1.031	.148	.218	.156	.801	.588	1.039	.062
DBC53H - 18 - *P*	1.125	1.218	1.156	.148	.218	.156	.801	.588	1.164	.082
DBC53H - 20 - *P*	1.250	1.312	1.250	.148	.218	.156	.863	.650	1.258	.100
DBC53H - 22 - *P*	1.375	1.438	1.375	.116	.186	.188	.895	.650	1.383	.115
DBC53H - 24 - *P*	1.500	1.564	1.500	.116	.186	.188	.895	.650	1.508	.268

Information contained herein is for reference only. Consult TE for new envelope drawings, updated specifications, and additions to product lines.

MIL-C-26482 Series 2 Hermetic Receptacles

Jam Nut Mount - DBC54H or DBA54H

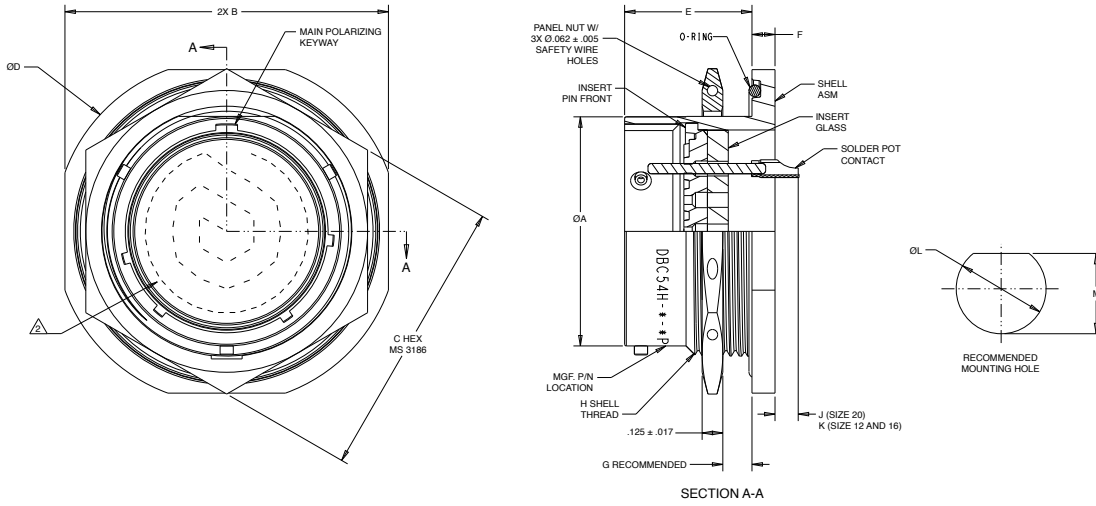

1. Dimensions are in inches unless otherwise specified
2. Insert arrangement per MIL-STD-1669
3. Mates with AFD56 - * - *S* plugs
4. Material:
Shell: Mild steel for DBC
 Stainless steel for DBA
Insulator: Glass insert
Contact:
 52 high nickel/iron alloy
 Insert pin front: fluorosilicone
5. Finish:
Shell: Tin over nickel plated for DBC
 Passivated stainless steel for DBA
Contact: Gold over nickel plate
6. Shell dimensions shown for pin unit only

Part Number	+.001 Z-.005	AA ± .015	BB ± .017	CC ± .015	DD ± .008	EE ± .008	FF Panel Thk		GG Thread Class 2A	HH ± .030	JJ ± .030	+.010 KK-.000	+.010 LL-.000	Weight Max (lb)
							Min	Max						
DBC54H - 8 - *P*	.473	.938	.750	1.062	.699	.105	.062	.187	.5625 - 24UNEF	.104	.174	.572	.537	.043
DBC54H - 10 - *P*	.590	1.062	.875	1.187	.699	.105	.062	.187	.6875 - 24UNEF	.104	.174	.697	.661	.061
DBC54H - 12 - *P*	.750	1.250	1.062	1.375	.699	.105	.062	.187	.8750 - 20UNEF	.104	.174	.895	.824	.088
DBC54H - 14 - *P*	.875	1.375	1.188	1.500	.699	.105	.062	.187	1.0000 - 20UNEF	.104	.174	1.010	.948	.110
DBC54H - 16 - *P*	1.000	1.500	1.312	1.625	.699	.105	.062	.187	1.1250 - 18UNEF	.104	.174	1.135	1.072	.131
DBC54H - 18 - *P*	1.125	1.625	1.438	1.750	.699	.105	.062	.187	1.2500 - 18UNEF	.104	.174	1.260	1.197	.172
DBC54H - 20 - *P*	1.250	1.812	1.562	1.938	.763	.138	.062	.250	1.3750 - 18UNEF	.069	.139	1.385	1.322	.211
DBC54H - 22 - *P*	1.375	1.938	1.688	2.062	.763	.138	.062	.250	1.5000 - 18UNEF	.069	.139	1.510	1.447	.242
DBC54H - 24 - *P*	1.500	2.062	1.812	2.187	.794	.138	.062	.250	1.6250 - 18UNEF	.069	.139	1.635	1.572	.293

DEUTSCH DBA Series Connectors

Extreme reliability in harsh aerospace and military applications



RELIABLE

- Visual and sensitive locking (blind mating)
- Double keying system to prevent any cross connection
- Leading clip preventing any accidental unmating on demand
- Interface and individual wire sealing

COMPREHENSIVE

- Mobile and "rack and panel" plugs, plugs with heavy duty lanyard
- Hermetic receptacles and feedthrough
- Removable contacts size 6 to 22, crimp, solder and PCB types

CUSTOM DESIGNED

- Cryogenic and high temperature versions
- Dead-Face systems
- Specials (High Speed, HF, pyrotechnic, 1553 bus)

TE Connectivity (TE)'s DEUTSCH DBA series push pull connectors are designed for severe environments in aeronautic, military and space applications. They are also ideal for rack and panel equipment. Thanks to their visual and sensitive push-pull locking system, the DBA series connectors are highly reliable. The wide range of inserts, shell types and accessories with multiple surface-finishing options makes integrated solutions for custom designs possible.

ENVIRONMENTAL

- **Temperature Range:** -55°C to +200°C
- **Thermal Shocks:** 5 cycles of -55°C to +200°C
- **Inferior Leakage:** 1.10^{-6} mbar.l.s-1 under 1 bar vacuum or 0.36 mm³/h (as per EN2591-322)
- **Corrosion:** Withstands 96 hours of salt spray

MECHANICAL

- **Shell: Material:** Steel, **Plating:** Tin over nickel plating
- **Plating:** Nickel
- **Insert Material:** Glass, thermosetting resin, fluorinated silicone
- **Insert Fluids Resistance:** Compliant with SAE/AS 81703
- **Insulation Resistance:** 5000 Meg ohms min @ 75°F per MIL-C-26482
- **Contact: Type:** Soldered bucket, **Plating:** Gold
- **Insert Contact Retention:**

Size 22: 4.40 daN	Size 16: 11.56 daN	Size 8: 11.56 daN
Size 20: 6.93 daN	Size 12: 11.56 daN	Size 6: 11.56 daN
- **Vibrations:** No mechanical nor electrical failure further to 12 hours vibration (4 hours in the 3 axes) 20 G from 10 to 2000 Hz. Resistance to sinusoidal and random vibrations 20 G effect during 3 minutes from 20 to 2000 Hz. Resistance to critical frequencies and constant accelerations, to pyrotechnic.
- **Physical Shocks:** 100 G, during 11 ms in the 3 axes
- **Durability:** 500 full mating / unmating cycles
- **Pressure Insert Retention:** 30 to 70 bars
- **Hermetics:** 1.10^{-6} mbar.l.s-1 under 1 bar vacuum or 0.36 mm³/h (as per EN2591-322)

ELECTRICAL

- **Withstanding Voltage:**
 - At Sea Level:** Service I - 1500 V eff. 50 Hz, Service II - 2300 V eff. 50 Hz
 - In Altitude:** At 33000 m Service I - 350 V, Service II - 500 V
- **Service Voltage:** Service I - 600 V eff. 50 Hz, Service II - 1000 V eff. 50 Hz
- **Insulation Resistance:** \geq at 5000 M Ω at 25°C and 60% R.H.
- **Mated Shell Conductivity:** Plugs with RFI fingers: \leq 50 m Ω
- **Contact Maximum Current:**

Size 20: 5A	Size 16: 10A	Size 12: 17A	Size 8: 33A
--------------------	---------------------	---------------------	--------------------
- **Diameter over Insulating Sheath:**

Size 22: 0.71 to 1.25 mm	Size 16: 1.35 to 2.62 mm	Size 8: 3.80 to 5.15 mm
Size 20: 1.01 to 2.10 mm	Size 12: 2.69 to 4.01 mm	Size 6: 4.80 to 5.35 mm
- **Allowed Wires Section:** For solder type contacts DBC-DBA

Size 20: 0.93 mm ²	Size 12: 3.18 mm ²
Size 16: 1.34 mm ²	Size 8: 8.98 mm ²

Arrangements

Male Insert Viewed from Front Face



3-0
3 Size 20
Contacts *



3-01
1 Size 8
Contact *



7-0
7 Size 20
Contacts *



12-0
12 Size 20
Contacts *

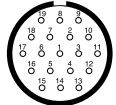

19-0
19 Size 20
Contacts

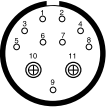

19-2
9 Size 20 Contacts
2 Size 8 Contacts *

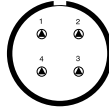

19-4
4 Size 12
Contacts *

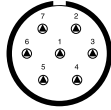

19-7
7 Size 12
Contacts *

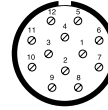

19-12
12 Size 16
Contacts *

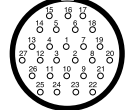

27-0
27 Size 20
Contacts *



27-2
14 Size 16
Contact *

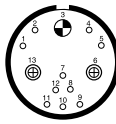

27-913
10 Size 20 Contacts
2 Size 8 Contacts
1 Size 6 Contact *

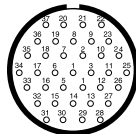

37-0
37 Size 20
Contacts *

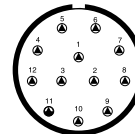

37-3
12 Size 12
Contacts *

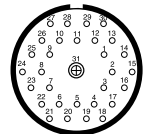

37-13
30 Size 20 Contacts
1 Size 8 Contact

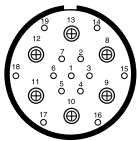

37-19
13 Size 20 Contacts
6 Size 8 Contacts *

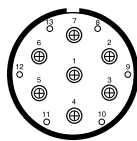

37-27
6 Size 20 Contacts
7 Size 8 Contacts *

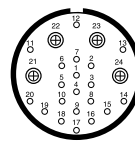

37-30
20 Size 20 Contacts
4 Size 8 Contacts *

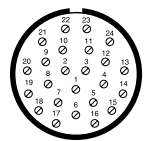

37-924
24 Size 16
Contacts *

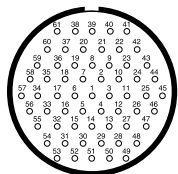

61-0
61 Size 20
Contact *

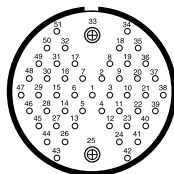

61-5
49 Size 20 Contacts
2 Size 8 Contacts *

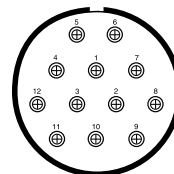

61-21
12 Size 8
Contacts *

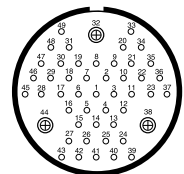

61-949
46 Size 20 Contacts
3 Size 8 Contacts

* For hermetic versions, consult TE Connectivity (TE).

DBA, DBC,
DHS

DEUTSCH DBA Series Connectors

Part Numbering

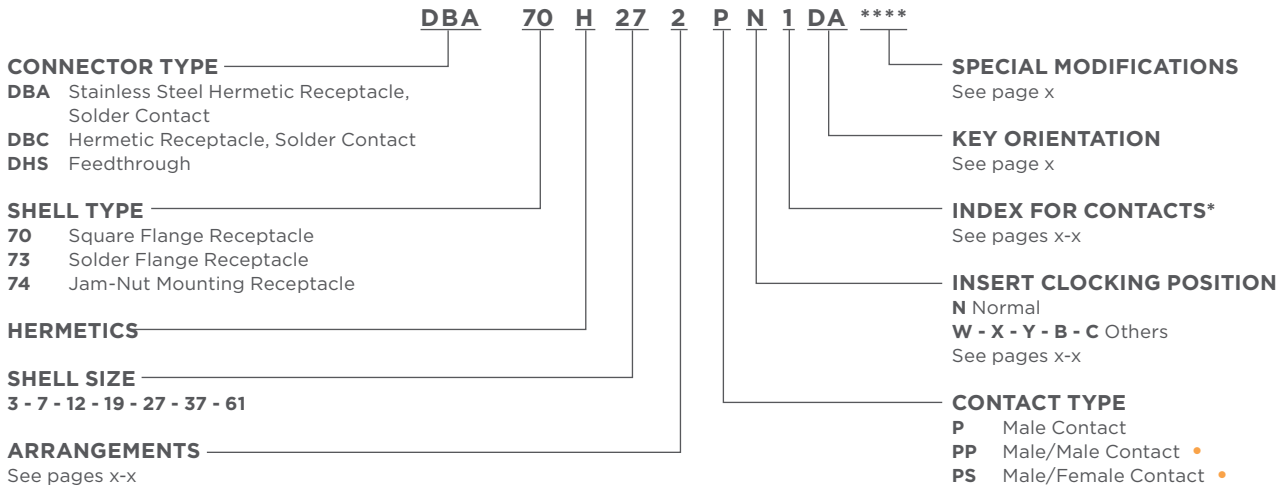

* Micro-coax sizes 16 and 12 available (see pages x and x)
 • Only for DHS

Hermetic Receptacles

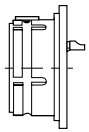

DBA 70H Square flange 4 holes mounting
DBC 70H

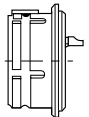

DBA 73H Solder flange
DBC 73H

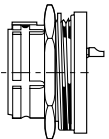

DBA 74H Jam-nut mounted receptacle
DBC 74H

Hermetic Feedthrough

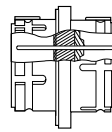

DHS 70H Square flange 4 holes mounting

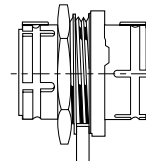

DHS 74H Jam-nut mounted receptacle

Accessories

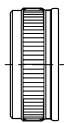

Nut

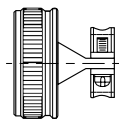

059
Straight Cable Clamp

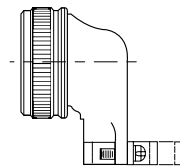

081
90° Cable Clamp

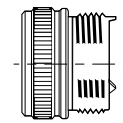

A 140
Adaptor

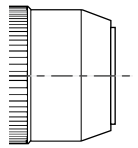

A 083
Potting Cup

DEUTSCH DBA Series Connectors

Insert Clocking Position

Clocking position is normal (N) when the insert vertical axis is intermingled with the shell keyway axis. An unkeying can be performed between 2 connectors of same layout by angular displacement of one of the inserts in its shell. This insert rotation is made in the clockwise for male layouts and in the counter clockwise for female layouts. Angular displacements on the hereafter table give clocking position W, X, Y, B or C.

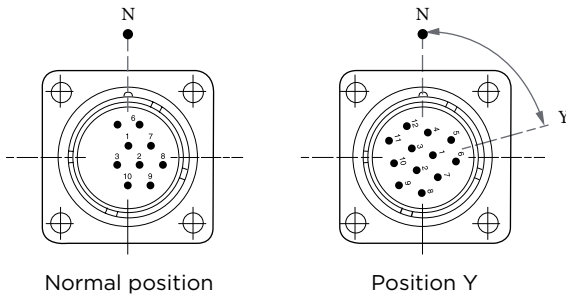

Example of insert angular displacement, male front face view

Arrangements	Clocking Position in Degrees					Contacts Sizes						Service
	W	X	Y	B	C	22	20	16	12	8	6	
3-0	25	50	75	150	220	—	3	—	—	—	—	I
3-01	—	—	—	—	—	—	—	—	—	1	—	—
7-0	27.30	47.30	75	150	225	—	7	—	—	—	—	I
12-0	15	50	75	150	225	—	12	—	—	—	—	I
19-0	25	50	75	150	225	—	19	—	—	—	—	I
19-2	25	50	75	150	225	—	9	—	—	2	—	I
19-4	—	—	22°30	135	247°30	—	—	—	4	—	—	I
19-7	—	—	75	150	225	—	—	—	7	—	—	I
19-12	25	50	75	150	225	—	—	12	—	—	—	I
27-0	25	50	75	150	225	—	27	—	—	—	—	I
27-2	25	50	75	150	225	—	—	14	—	—	—	II
27-8	25	50	75	150	225	—	—	6	4	—	—	I
27-13	25	50	75	150	225	—	12	—	—	3	—	I
37-0	25	50	75	150	225	—	37	—	—	—	—	I
37-3	20	70	75	—	—	—	—	—	12	—	—	I
37-13	—	—	75	150	225	—	30	—	—	1	—	I
37-19	25	50	75	150	225	—	13	—	—	6	—	I
37-27	—	—	75	150	225	—	6	—	—	7	—	I
37-30	25	50	75	150	225	—	20	—	—	4	—	I
37-922	45	90	—	—	—	—	20	—	—	—	2	I
37-924	105	13	—	—	—	—	—	24	—	—	—	I
37-961	—	—	—	—	—	61	—	—	—	—	—	—
61-0	25	50	75	150	225	—	61	—	—	—	—	I
61-5	25	50	75	150	225	—	49	—	—	2	—	I
61-14	25	50	75	150	225	—	—	37	—	—	—	—
61-21	25	50	75	150	225	—	—	—	—	12	—	I
61-42	—	67°30	—	—	—	—	29	4	8	—	—	—
61-929	—	—	—	—	—	—	15	8	—	6	—	—
61-948	45	90	135	—	—	—	42	4	—	—	2	I
61-949	25	50	75	150	225	—	46	—	—	3	—	—

DBA, DBC,
DHS

DEUTSCH DBA Series Connectors

Key Orientation (Except 79)

Receptacle Front Face View

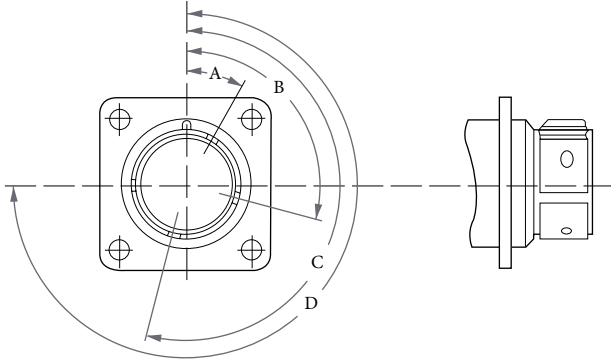

Plug Front Face View

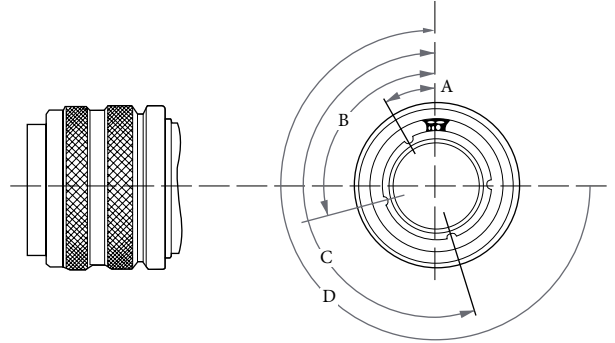

Angles Size	3				7				12				19				27				37				61							
	A	B	C	D	A	B	C	D	A	B	C	D	A	B	C	D	A	B	C	D	A	B	C	D	A	B	C	D				
Standard	23	97	187	—	23	97	187	277	30	105	195	270	30	105	195	270	30	105	195	270	30	105	195	270	30	105	195	270	30	105	195	270
DA	—	—	—	—	23	105	195	300	30	90	225	315	40	105	195	270	40	105	195	270	40	105	195	270	40	105	195	270	40	105	195	270
DB	—	—	—	—	23	115	210	285	30	120	210	285	30	115	195	270	30	115	195	270	30	115	195	270	30	115	195	270	30	115	195	270
DC	—	—	—	—	30	120	195	285	30	135	180	300	30	115	210	270	30	115	210	270	30	115	210	270	30	115	210	270	30	115	210	270
DD	—	—	—	—	30	97	210	270	45	105	210	315	30	115	195	280	30	115	195	280	30	115	195	280	30	115	195	280	30	115	195	280
DE	—	—	—	—	—	—	—	—	45	90	180	285	—	—	—	—	—	—	—	—	30	90	170	270	30	90	170	270	30	90	170	270
DF	—	—	—	—	—	—	—	—	45	120	270	300	—	—	—	—	—	—	—	—	30	115	170	255	30	115	170	255	30	115	170	255
DG	—	—	—	—	—	—	—	—	45	135	195	225	—	—	—	—	—	—	—	—	30	115	180	300	30	115	180	300	30	115	180	300

Dimensions in mm



DEUTSCH DBA Series Connectors

DBA / DBC 70H - Hermetic Square Flange Receptacle

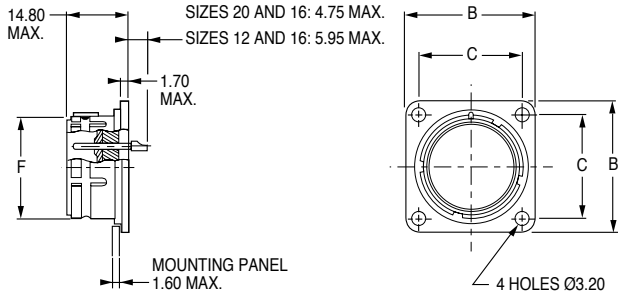

Part Number	B max	C ±0,1	F max	Part Number
DBA 70H-3-** P *	22.32	15.88	11.11	DBC 70H-3-** P *
DBA 70H-7-** P *	25.50	18.26	14.54	DBC 70H-7-** P *
DBA 70H-12-** P *	27.86	20.65	17.97	DBC 70H-12-** P *
DBA 70H-19-** P *	30.25	23.02	21.50	DBC 70H-19-** P *
DBA 70H-27-** P *	32.64	24.59	25.44	DBC 70H-27-** P *
DBA 70H-37-** P *	36.60	30.15	28.51	DBC 70H-37-** P *
DBA 70H-61-** P *	45.34	36.47	35.80	DBC 70H-61-** P *

Dimensions in mm

DBA / DBC 73H - Hermetic Solder Flange Receptacle

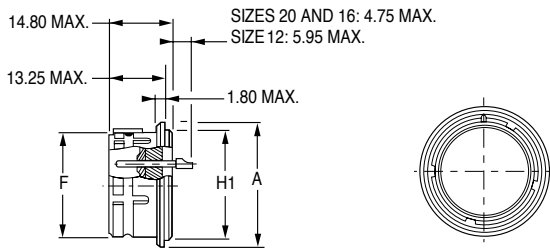

Part Number	A max	F max	H1 max	Part Number
DBA 73H-3-** P *	15.09	11.11	12.62	DBC 73H-3 ** P *
DBA 73H-7-** P *	19.10	14.54	15.80	DBC 73H-7 ** P *
DBA 73H-12-** P *	22.28	17.97	18.97	DBC 73H-12 ** P *
DBA 73H-19-** P *	25.45	21.50	22.96	DBC 73H-19 ** P *
DBA 73H-27-** P *	30.07	25.44	26.92	DBC 73H-27 ** P *
DBA 73H-37-** P *	32.59	28.51	29.28	DBC 73H-37 ** P *
DBA 73H-61-** P *	39.72	35.80	36.44	DBC 73H-61 ** P *

Dimensions in mm

DBA / DBC 74H - Hermetic Jam-Nut Mounting Receptacle

Part Number	A max	B max	F max	M max	Max. Nut Panel Tightening Torque	Part Number
DBA 74H-3 ** P *	19.53	18.58	11.11	15.97	0.70 daN.m	DBC 74H-3 ** P *
DBA 74H-7 ** P *	22.70	21.76	14.54	20.72	1.00 daN.m	DBC 74H-7 ** P *
DBA 74H-12 ** P *	25.77	24.93	17.97	23.90	1.30 daN.m	DBC 74H-12 ** P *
DBA 74H-19 ** P *	30.65	29.72	21.50	27.07	1.50 daN.m	DBC 74H-19 ** P *
DBA 74H-27 ** P *	33.83	32.88	25.44	31.34	1.80 daN.m	DBC 74H-27 ** P *
DBA 74H-37 ** P *	36.98	36.16	28.51	35.10	2.20 daN.m	DBC 74H-37 ** P *
DBA 74H-61 ** P *	48.23	47.29	35.80	42.97	2.90 daN.m	DBC 74H-61 ** P *

Dimensions in mm

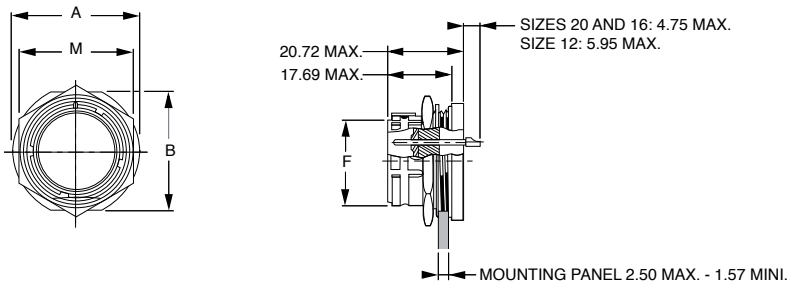

DEUTSCH DBA Series Connectors

DHS 70H - Hermetic Square Flange Receptacle Feedthrough

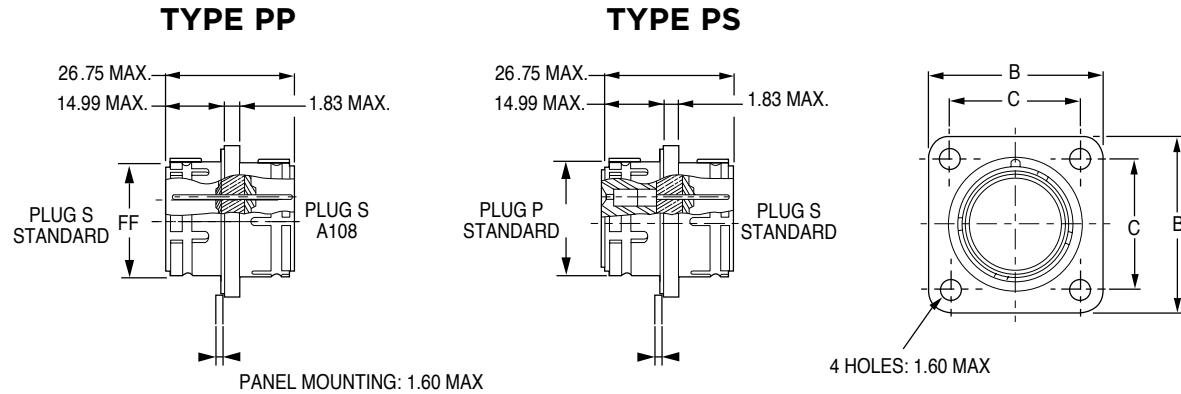

Part Number	B max	C ±0,1	F max	Part Number
DHS 70H-3-**-PP *	22.65	15.88	11.20	DHS 70H-3-**-PS *
DHS 70H-7-**-PP *	25.85	18.26	14.63	DHS 70H-7-**-PS *
DHS 70H-12-**-PP *	28.20	20.65	18.03	DHS 70H-12-**-PS *
DHS 70H-19-**-PP *	30.60	23.02	21.56	DHS 70H-19-**-PS *
DHS 70H-27-**-PP *	32.95	24.59	25.50	DHS 70H-27-**-PS *
DHS 70H-37-**-PP *	36.95	30.15	28.60	DHS 70H-37-**-PS *
DHS 70H-61-**-PP *	48.65	36.47	35.91	DHS 70H-61-**-PS *

Dimensions in mm

DHS 74H - Hermetic Jam-Nut Mounting Receptacle Feedthrough

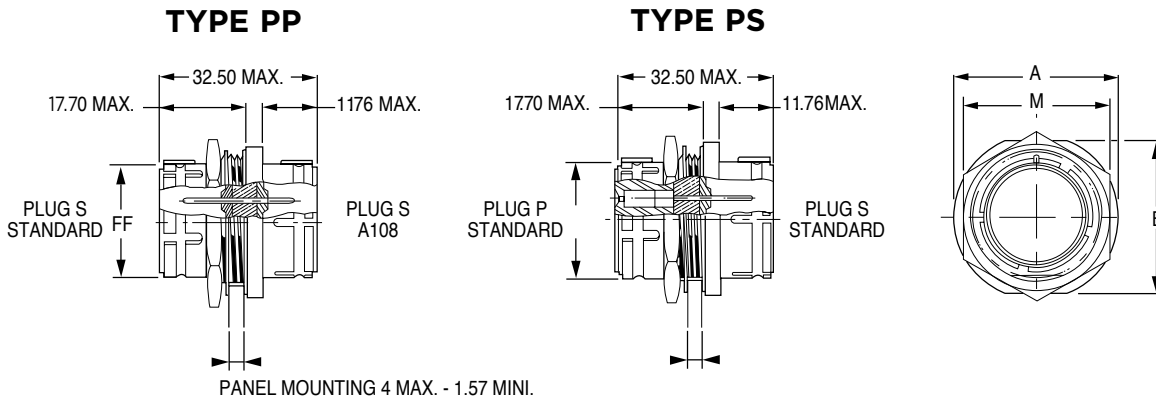

Part Number	A max	B max	F max	M max	Max. Nut Panel Tightening Torque	Part Number
DHS 74H-3-**-PP *	19.81	18.84	11.20	15.87	0.70 daN.m	DHS 74H-3-**-PS *
DHS 74H-7-**-PP *	22.98	22.02	14.63	20.62	1.00 daN.m	DHS 74H-7-**-PS *
DHS 74H-12-**-PP *	26.16	25.19	18.03	23.79	1.30 daN.m	DHS 74H-12-**-PS *
DHS 74H-19-**-PP *	30.93	29.97	21.56	26.97	1.50 daN.m	DHS 74H-19-**-PS *
DHS 74H-27-**-PP *	34.11	33.14	25.50	31.75	1.80 daN.m	DHS 74H-27-**-PS *
DHS 74H-37-**-PP *	37.26	36.32	28.60	37.26	2.20 daN.m	DHS 74H-37-**-PS *
DHS 74H-61-**-PP *	48.51	47.59	35.91	42.87	2.90 daN.m	DHS 74H-61-**-PS *

Dimensions in mm

Panel sealing gasket to be ordered separately, see page xx. Panel cutout, see page xx. O'ring to be ordered separately, see page xx. Panel cutout, see page xx.

DEUTSCH DBA Series Connectors

Panel Cutout for Sealed and Hermetic Receptacles

Square Flange

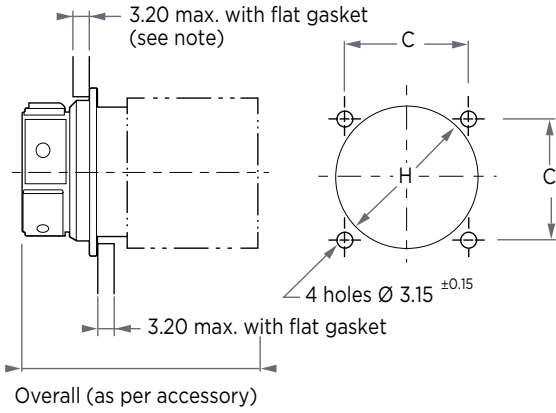

Jam-Nut Mounted

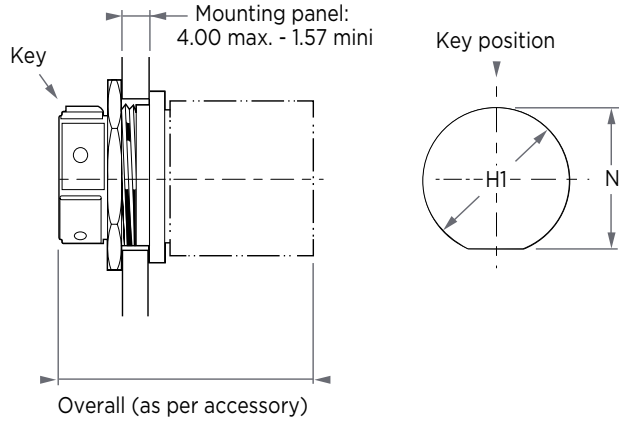

Note: For utilization on rack connectors, see page 40.

For Hermetic Receptacle

Solder Flange

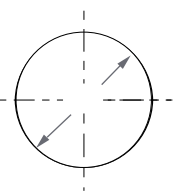

Size	C ± 0.1	H + 0 - 0.2	H1 + 0.2 - 0	H2 ± 0.38	H3 Max	N + 0.1 - 0	N1 + 0.1 ± 0.38
3	15.90	14.80	14.40	17.04	14.40	13.56	21.41
7	18.26	19.40	17.55	20.62	17.55	16.79	24.99
12	20.62	22.60	20.73	23.80	20.73	19.91	27.96
19	23.02	25.75	25.48	26.97	25.48	24.61	31.34
27	24.58	28.95	28.65	30.56	28.65	27.81	34.92
37	30.12	32.35	31.83	34.92	31.83	30.99	38.89

Dimensions in mm

Coax Braid Nut

For Hermetic Coax

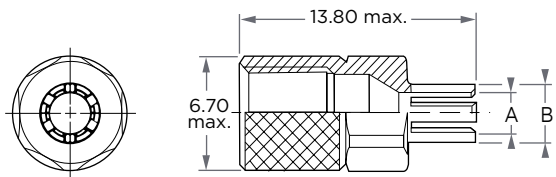

Index	Cable	Part Number	A max	B max	Allowed Wire External
Without	RG 178/U	14.60	20.45	79.00	DBAS C 74-3
	RG 179/U	046-0006-01	2.50	3.50	140 to 2.70
	RG 196/U	20.90	20.45	95.00	DBAS C 74-12
4	RG 174/U	25.70	20.45	95.00	DBAS C 74-19
	RG 187/U	046-0006-02	3.00	4.00	2.70 to 2.90
	RG 188/U	32.00	20.45	111.00	DBAS C 74-37
1	RG 180/U	38.40	20.45	111.00	DBAS C 74-61
	RG 195/U	046-0006-03	4.20	5.20	3.40 to 3.90
5	RG 141/U	046-0006-04	5.05	6.10	4.50 to 5.00

Dimensions in mm

Wiring instruction.
NC 025-031.

MIL-C-83723 Series 9602 Connectors

Rugged reliability in harsh environments



TE Connectivity (TE)'s DEUTSCH 9602 series hermetic connectors are designed for severe environments in aeronautic, military and space applications. Made of stainless steel or mild steel, they have compression glass, compressed at more than 1000°C in a regulated temperature oven. Series 9602 insulators and joints are made of silicone elastomers. Special modifications are available, such as A868, which withstands Skydrol (front part) and kerosene (rear part), for example.

ENVIRONMENTAL

- **Temperature Range:** -55°C to +175°C

RELIABLE

- Visual and sensitive locking (blind mating)
- Double keying system to prevent any cross connection
- Leading clip preventing any accidental unmating on demand
- Interface and individual wire sealing

COMPREHENSIVE

- Mobile and "rack and panel" plugs, plugs with heavy duty lanyard
- Sealed receptacles and hermetic receptacles and feedthrough
- Removable contacts size 6 to 22, crimp, solder and PCB types
- Savers, protective caps and dummy receptacles

CUSTOM DESIGNED

- Cryogenic and high temperature versions
- Dead-Face systems
- Specials (High Speed, HF, pyrotechnic, 1553 bus)

MECHANICAL

- **Shell: 9602:** 00H Nickel Plated Steel
9062: 04H Stainless Steel
- **Insert Material:** Glass
- **Interfacial Insert:** Silicone Elastomer or Fluorated Silicone
- **Contact Type:** Solder Type
- **Contact Material:** Nickel Iron Alloy
- **Contact Plating:** Gold
- **O-Ring:** Viton®

ELECTRICAL

- **Withstanding Voltage:**
At Sea Level: 1500 V. 50 Hz (R.M.S.)
In Altitude: At 15000 m - 500 V
At 21000 m - 375 V
At 33000 m - 200 V
- **Insulation Resistance:** 5000 MΩ at 25°C and 60% HR
- **Contact Maximum Current:**
Size 20: 5A **Size 16:** 10A

Arrangements



8-33
3 Size 20
Contacts



8-3A / 8-98
3 Size 20
Contacts

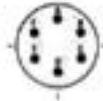

10-6
6 Size 20
Contacts

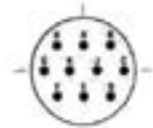

12-10
10 Size 20
Contacts

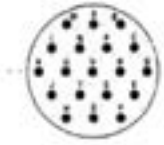

14-19
19 Size 20
Contacts

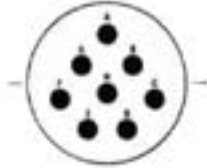

16-8*
8 Size 16
Contacts

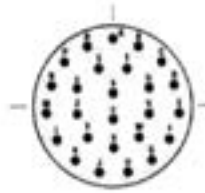

16-26
26 Size 20
Contacts

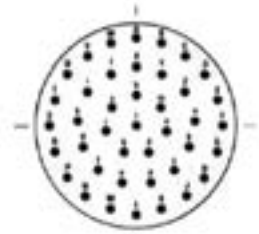

20-41
41 Size 20
Contacts

Normalized insert arrangements

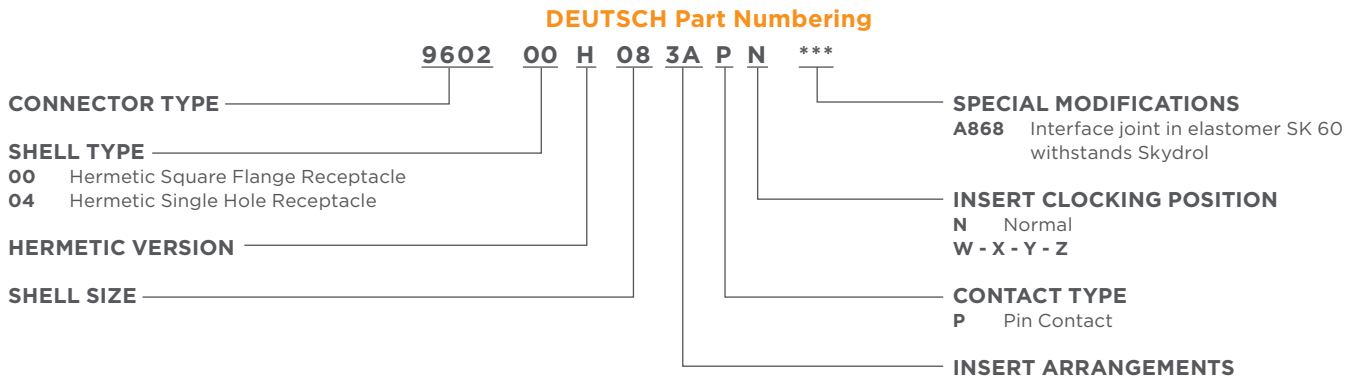

MIL-C-83723 Series 9602 Connectors - PAN 6432

Hermetic Square Flange Receptacle Type 00H

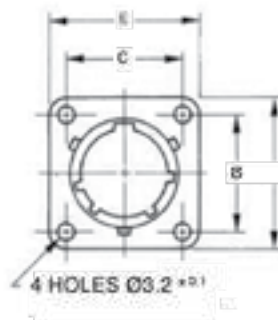
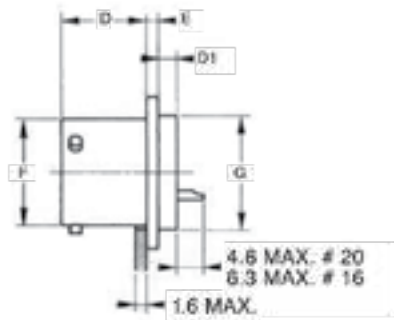

Panel Boring

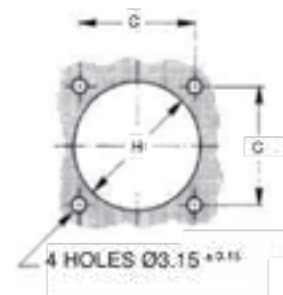

DEUTSCH Reference	B Max	C ± 0.1	D Max	D1 Max	E Max	F Max	G Max	H + 0.0 - 0.2	Panavia Reference	Flat Gasket Reference
9602 00-H- 8-**-P/N	21.00	15.08	15.20	3.20	1.98	12.03	14.30	14.70	PAN 6432 3-T- 8-**-P	108-0003- 8-395
9602 00-H- 10-**-P/N	24.20	18.26	15.20	3.20	1.98	15.01	17.10	17.50	PAN 6432 3-T- 10-**-P	108-0003- 10-395
9602 00-H- 12-**-P/N	26.55	20.62	15.20	3.20	1.98	19.07	19.90	20.30	PAN 6432 3-T- 12-**-P	108-0003- 12-395
9602 00-H- 14-**-P/N	28.95	23.02	15.20	3.20	1.98	22.24	23.05	23.45	PAN 6432 3-T- 14-**-P	108-0003- 14-395
9602 00-H- 16-**-P/N	31.30	24.58	15.20	3.20	1.98	25.42	26.25	26.65	PAN 6432 3-T- 16-**-P	108-0003- 16-395
9602 00-H- 20-**-P/N	36.85	29.36	16.80	3.20	2.40	31.77	31.80	32.20	PAN 6432 3-T- 20-**-P	108-0003- 20-395

Hermetic Single Hole Receptacle Type 04H

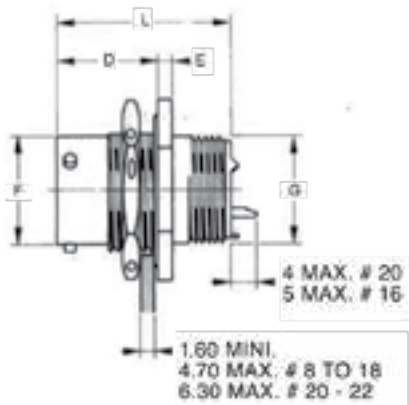

Panel Boring

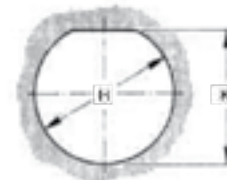

DEUTSCH Reference	A Max	B Max	D ± 0.1	E Max	F Max	G Max	H + 0.0 - 0.2	K + 0.0 - 0.2	L Max	M Max	Panavia Reference
9602 04-H- 8-**-P/N	27.40	24.20	17.80	2.90	12.03	12.70	14.70	13.80	31.35	19.50	PAN 6432 3-V- 8-**-P
9602 04-H- 10-**-P/N	30.60	27.40	17.80	2.90	15.01	15.85	17.90	17.00	31.35	22.70	PAN 6432 3-V- 10-**-P
9602 04-H- 12-**-P/N	35.30	32.10	17.80	2.90	19.07	19.05	22.90	21.10	31.35	27.40	PAN 6432 3-V- 12-**-P
9602 04-H- 14-**-P/N	38.50	35.30	17.80	2.90	22.24	22.20	25.80	24.30	31.35	30.60	PAN 6432 3-V- 14-**-P
9602 04-H- 16-**-P/N	41.70	38.50	17.80	2.90	25.42	25.40	29.00	27.40	31.35	33.70	PAN 6432 3-V- 16-**-P
9602 04-H- 20-**-P/N	49.60	46.40	19.40	3.80	31.77	30.15	35.40	33.80	32.95	40.10	PAN 6432 3-V- 20-**-P

MIL-C-5015 Series Connectors



Description

TE Connectivity (TE)'s DEUTSCH DF02 and DH02 series intermate with all standard MIL-C-5015 plugs. DF02 hermetic receptacles are built to meet or exceed the requirements of MIL-C-5015. Our standard receptacles are available in eyelet, solder cup or short solder cup terminated pin type contacts.

TE also offers special application receptacles. Consult us for the availability of our specially built products.

ELECTRICAL

- **Dielectric Withstanding Voltage at Sea Level:**
 #16 Contacts: 1500 V AC rms @ 60Hz
 #12 Contacts: 1500 V AC rms @ 60Hz
- **Current Rating:**
 #16 Contacts: 22 amps
 #12 Contacts: 41 amps
- **Contact Resistance:**
 #16: 80 mV Drop
 #12: 80 mV Drop
- **Insulation Resistance:** 1000 Meg ohms min @ 75°F per MIL-C-5015
- **Thermal Shock:** No deterioration or failure after 5 cycles @ -67°F to +392°F

ENVIRONMENTAL

- **Temperature Range:** -67°F to +392°F
- **Vibration:** Exceeds requirements of MIL-STD-1344, method 2005 per MIL-C-5015
- **Physical Shock:** No unlocking or electrical discontinuity when tested per half sine wave of 50 g per MIL-C-5015
- **Air Leakage:** Less than 0.1 micron cu. ft./hr. at 15 psi differential per MIL-C-5015 and MIL-STD-202, method 112
- **Durability:** 500 cycles of engagement per MIL-C-5015
- **Moisture Resistance:** Meets requirements of MIL-C-5015
- **Corrosion:** Exceeds requirements of MIL-STD-1344 method 1001 per Mil-C-5015 using standard plating
- **Usable Wire Size:**
 #16 Contacts: #16 AWG Max
 #12 Contacts: #12 AWG Max

STANDARDS AND SPECIFICATIONS

- Qualified to MIL-C-5015

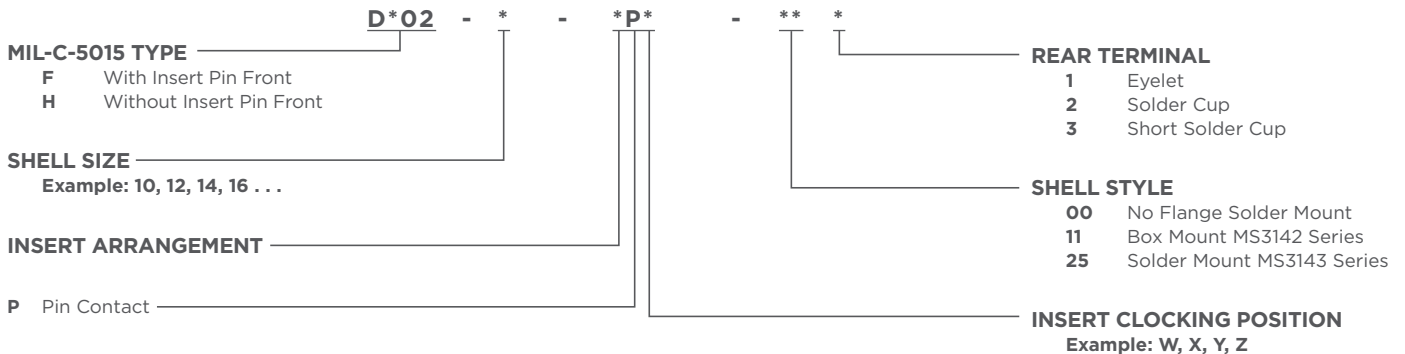

MIL-C-5015 Series Connectors

Box Mount

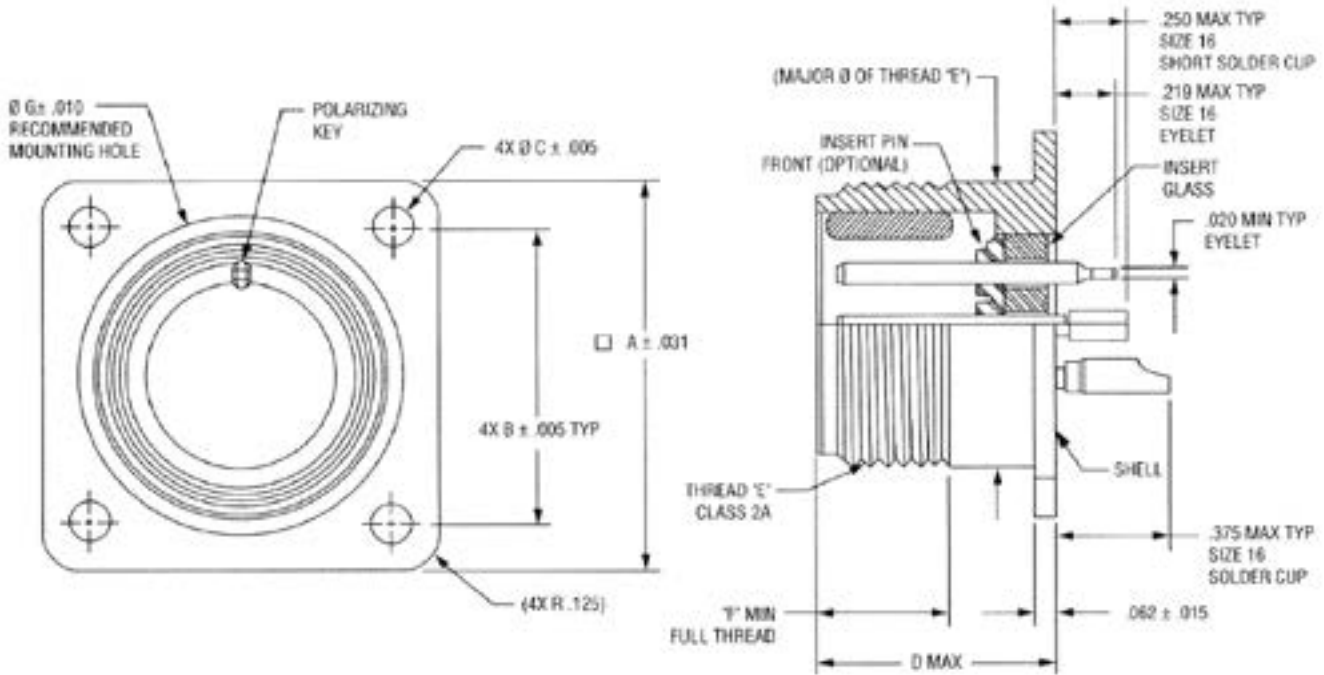

Part Number	Shell Size	A	B	C	D	E Thread	F	G
DF02 - 10SL - *P* - 11*	10SL	1.000	.719	.120	.730	.6250 - 24UNEF	.375	.688
DF02 - 12 - *P* - 11*	12	1.094	.812	.120	.915	.7500 - 20UNEF	.625	.812
DF02 - 12S - *P* - 11*	12S	1.094	.812	.120	.730	.7500 - 20UNEF	.375	.812
DF02 - 14 - *P* - 11*	14	1.188	.906	.120	.915	.8750 - 20UNEF	.625	.938
DF02 - 14S - *P* - 11*	14S	1.188	.906	.120	.730	.8750 - 20UNEF	.375	.938
DF02 - 16 - *P* - 11*	16	1.281	.969	.120	.915	1.000 - 20UNEF	.625	1.062
DF02 - 16S - *P* - 11*	16S	1.281	.969	.120	.730	1.000 - 20UNEF	.375	1.062
DF02 - 18 - *P* - 11*	18	1.375	1.062	.120	.915	1.1250 - 18UNEF	.625	1.188
DF02 - 20 - *P* - 11*	20	1.500	1.156	.120	.915	1.2500 - 18UNEF	.625	1.312

Insert Arrangements

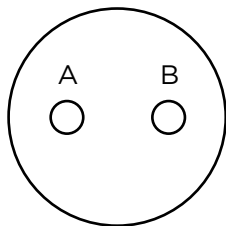

10-4
2 Size 16
Contacts

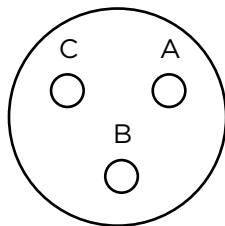

10-3
3 Size 16
Contacts

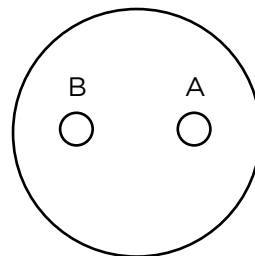

12-3
2 Size 16
Contacts

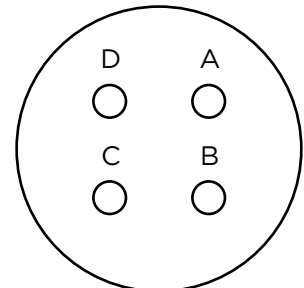

14-2
2 Size 16
Contacts

Consult TE for availability of arrangements not shown

MIL-C-5015 Series Connectors

Solder Mount

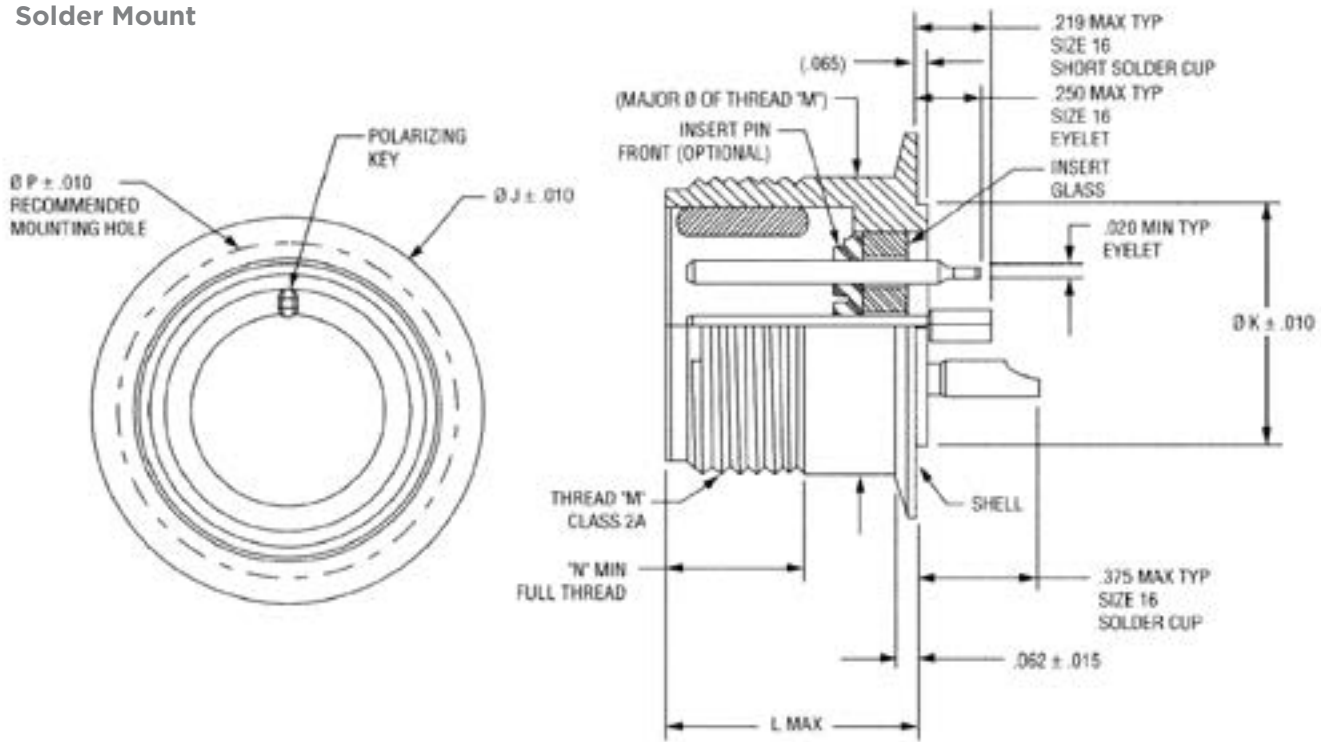

Part Number	Shell Size	J	K	L	M Thread	N	P
DF02 - 10SL - *P* - 25*	10SL	.875	.490	.730	.6250 - 24UNEF	.375	.688
DF02 - 12 - *P* - 25*	12	1.000	.646	.915	.7500 - 20UNEF	.625	.812
DF02 - 12S - *P* - 25*	12S	1.000	.646	.730	.7500 - 20UNEF	.375	.812
DF02 - 14 - *P* - 25*	14	1.125	.709	.915	.8750 - 20UNEF	.625	.938
DF02 - 14S - *P* - 25*	14S	1.125	.709	.730	.8750 - 20UNEF	.375	.938
DF02 - 16 - *P* - 25*	16	1.250	.834	.915	1.000 - 20UNEF	.625	1.062
DF02 - 16S - *P* - 25*	16S	1.250	.834	.730	1.000 - 20UNEF	.375	1.062
DF02 - 18 - *P* - 25*	18	1.375	.959	.915	1.1250 - 18UNEF	.625	1.188
DF02 - 20 - *P* - 25*	20	1.500	1.146	.915	1.2500 - 18UNEF	.625	1.312

Insert Arrangements

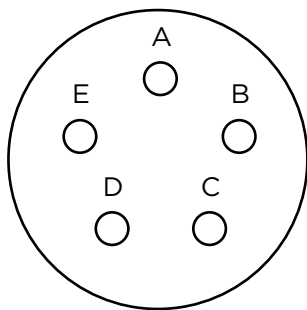

14-5
5 Size 16
Contacts

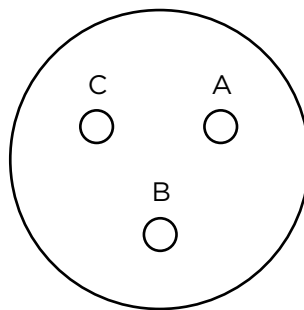

14-7
3 Size 16
Contacts

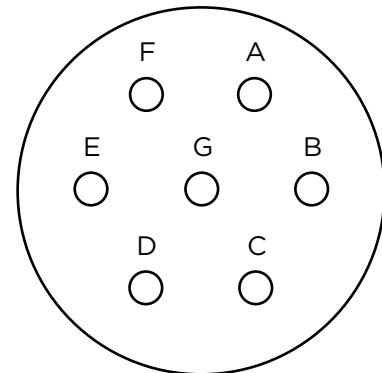

16-1
7 Size 16
Contacts

Consult TE for availability of arrangements not shown

MIL-C-5015 Series Connectors

No Flange Solder Mount

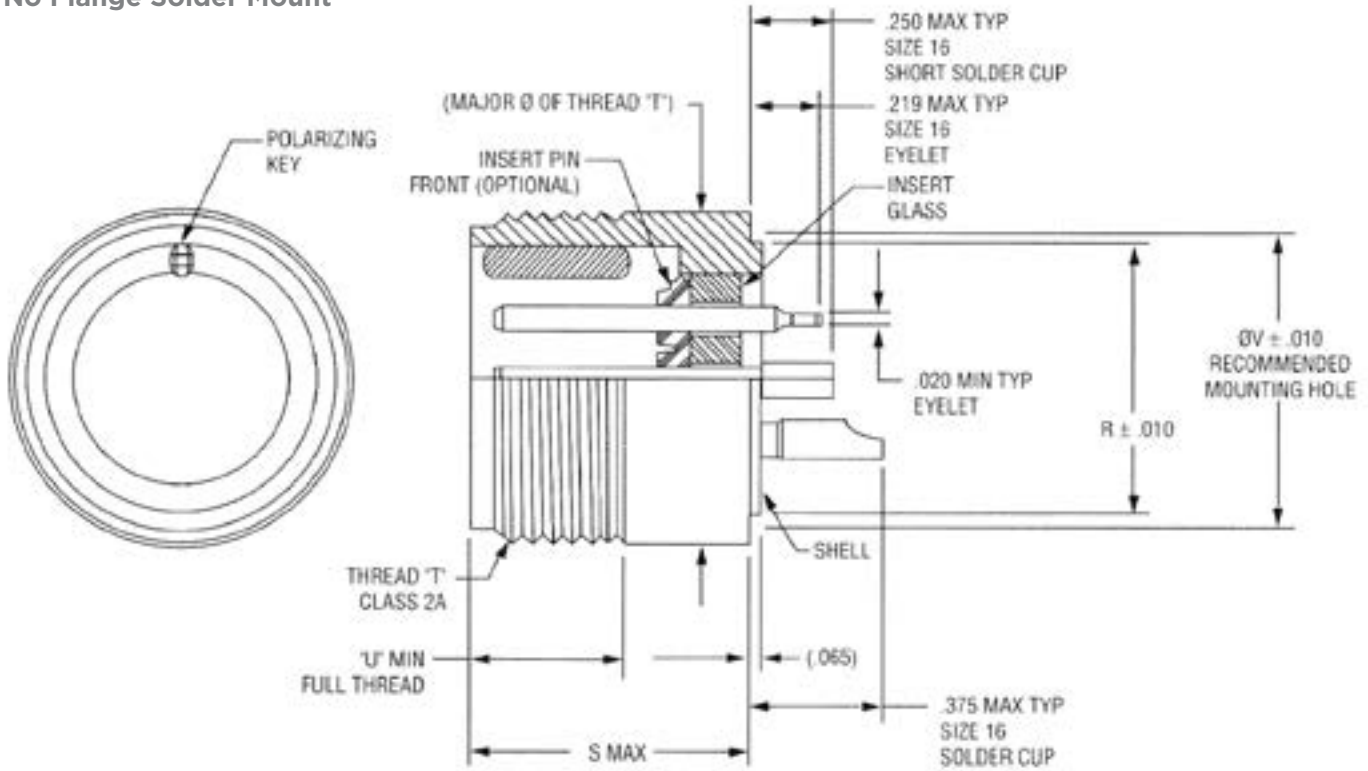

Part Number	Shell Size	R	S	T Thread	U	V
DF02 - 10SL - *P* - 00*	10SL	.490	.730	.6250 - 24UNEF	.375	.530
DF02 - 12 - *P* - 00*	12	.646	.915	.7500 - 20UNEF	.625	.686
DF02 - 12S - *P* - 00*	12S	.646	.730	.7500 - 20UNEF	.375	.686
DF02 - 14 - *P* - 00*	14	.709	.915	.8750 - 20UNEF	.625	.749
DF02 - 14S - *P* - 00*	14S	.709	.730	.8750 - 20UNEF	.375	.749
DF02 - 16 - *P* - 00*	16	.834	.915	1.000 - 20UNEF	.625	.874
DF02 - 16S - *P* - 00*	16S	.834	.730	1.000 - 20UNEF	.375	.874
DF02 - 18 - *P* - 00*	18	.959	.915	1.1250 - 18UNEF	.625	.999
DF02 - 20 - *P* - 00*	20	1.146	.915	2.2500 - 18UNEF	.625	1.186

Empower Engineers to Solve Problems, Moving the World Forward.

AMP | AGASTAT | CII | DEUTSCH | DRI | HARTMAN | KILOVAC
MICRODOT | NANONICS | POLAMCO | Raychem | SEACON

CONNECT WITH US

We make it easy to connect with our experts and are ready to provide all the support you need. Visit te.com/support to chat with a Product Information Specialist.

QUALITY STARTS WITH THE RIGHT APPLICATION TOOLING

Creating a quality crimp connection is essential to delivering high performance and reliability in extreme environments. From low to high volume wire processing, TE has you covered with a full range of application tooling and a global field service team.

- [View all application tooling](#)
- [Connect with our experts to find the right tool for your application](#)

te.com/hermetic-connectors

AMP, AGASTAT, CII, DEUTSCH, DRI, HARTMAN, KILOVAC, L. L. ROWE, MICRODOT, NANONICS, POLAMCO, Raychem, SEACON, TE, TE Connectivity and the TE connectivity (logo) are trademarks owned or licensed by TE Connectivity. Other products, logos, and company names mentioned herein may be trademarks of their respective owners.

Kovar is a registered trademark of Carpenter Technology Corporation. Alumel and Chromel are registered trademarks of Concept Alloys, Inc. Viton is a registered trademark of Dupont.

The information given herein, including drawings, illustrations and schematics which are intended for illustration purposes only, is believed to be reliable. However, TE Connectivity makes no warranties as to its accuracy or completeness and disclaims any liability in connection with its use. TE Connectivity's obligations shall only be as set forth in TE Connectivity's Standard Terms and Conditions of Sale for this product and in no case will TE Connectivity be liable for any incidental, indirect or consequential damages arising out of the sale, resale, use or misuse of the product. Users of TE Connectivity products should make their own evaluation to determine the suitability of each such product for the specific application.

© 2023 TE Connectivity All Rights Reserved.

1-1773915-9 01/23

HERMETIC CONNECTORS

TE Connectivity
Aerospace, Defense & Marine
2900 Fulling Mill Road
Middletown, PA 17057