

8 GHz to 16 GHz, 4-Channel, X Band and Ku Band Beamformer

FEATURES

- ▶ 8 GHz to 16 GHz frequency range
- ▶ Half-duplex for transmit and receive modes
- ▶ Single-pin transmit and receive control
- ▶ 360° phase adjustment range
- ▶ 2.8° phase resolution
- ▶ ≥31 dB gain adjustment range
- ▶ ≤0.5 dB gain resolution
- ▶ Bias and control for external transmit and receive modules
- ▶ Memory for 121 prestored beam positions
- ▶ Four -20 dBm to +10 dBm power detectors
- ▶ Integrated temperature sensor
- ▶ Integrated 8-bit ADC for power detectors and temperature sensor
- ▶ Programmable bias modes
- ▶ 4-wire SPI interface

APPLICATIONS

- ▶ Phased array radar
- ▶ Satellite communications systems

GENERAL DESCRIPTION

The ADAR1000 is a 4-channel, X and Ku frequency band, beam-forming core chip for phased arrays. This device operates in half-duplex between receive and transmit modes. In receive mode, input signals pass through four receive channels and are combined and output at the common RF_IO pin. In transmit mode, the RF_IO input signal is split and passes through the four transmit channels. In both modes, the ADAR1000 provides a ≥31 dB gain adjustment range and a full 360° phase adjustment range in each radio frequency (RF) channel, with 6-bit resolution (less than ≤0.5 dB and 2.8°, respectively).

A simple 4-wire serial port interface (SPI) controls all of the on-chip registers. In addition, two address pins allow SPI control of up to four devices on the same serial lines. Dedicated transmit and receive load pins also provide synchronization of all ADAR1000 chips in the same array, and a single pin controls fast switching between the transmit and receive modes.

The ADAR1000 is fabricated in a silicon-germanium, bipolar CMOS (BiCMOS) process. The device is available in a compact, 88-terminal, 7 mm × 7 mm, LGA package and is specified from -40°C to +85°C.

FUNCTIONAL BLOCK DIAGRAM

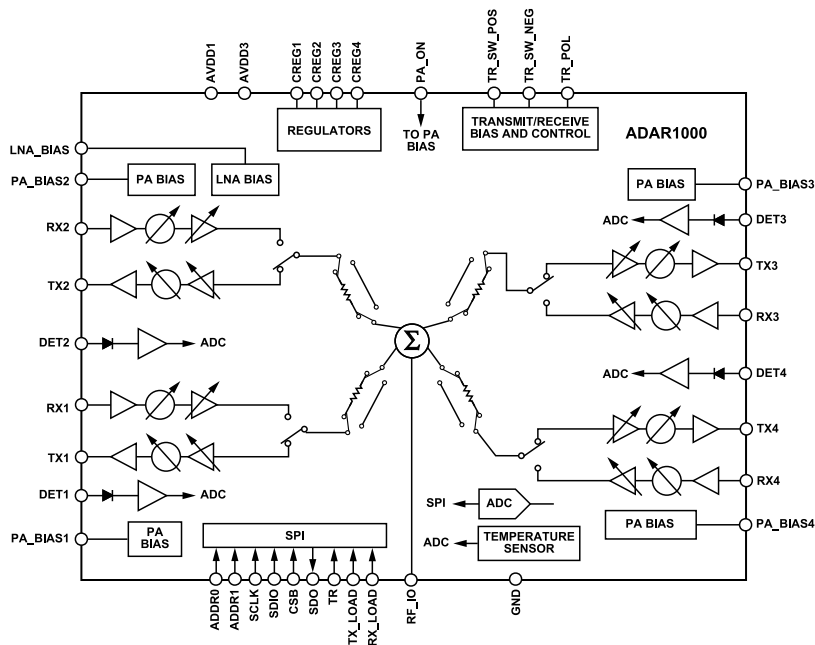

Figure 1.

TABLE OF CONTENTS

Features.....	1	Memory Access.....	32
Applications.....	1	Calibration	34
General Description.....	1	Memory Address Decoding.....	34
Functional Block Diagram.....	1	Memory Map.....	34
Specifications.....	5	Applications Information.....	35
Timing Specifications.....	8	Gain Control Registers.....	35
Absolute Maximum Ratings.....	11	Switched Attenuator Control.....	35
Thermal Resistance.....	11	Phase Control Registers.....	36
ESD Caution.....	11	Transmit and Receive Subcircuit Control.....	37
Pin Configuration and Function Descriptions.....	12	Transmit and Receive Switch Driver Control.....	38
Typical Performance Characteristics.....	15	PA Bias Output Control.....	39
Equivalent Circuits.....	27	LNA Bias Output Control.....	40
Theory of Operation.....	28	PA Bias, LNA Bias, and Switch Bias Setup	
RF Path.....	28	Examples.....	41
Digital Interface.....	28	Transmit/Receive Delay Control.....	43
Phase and Gain Control.....	29	ADAR1000 and ADTR1107.....	44
Receive Output Noise and Noise Figure.....	29	Powering the ADAR1000.....	45
Transmit and Receive Control.....	29	Return Loss While Powered Down.....	47
RF Subcircuit Bias Control	30	SPI Considerations	47
RF Subcircuit Enables and Disables.....	30	SPI Programming Example.....	50
Power Detectors	31	Register Map.....	53
External Amplifier Bias Drivers	31	Register Descriptions.....	57
External Switch Control.....	31	Outline Dimensions.....	79
ADC Operation.....	32	Ordering Guide.....	79
Chip Addressing.....	32	Evaluation Boards.....	79

REVISION HISTORY

7/2022—Rev. A to Rev. B

Changes to General Description Section.....	1
Changes to Specifications Section and Table 1.....	5
Added Minimum Clock Period ($1/t_{SCLK}$) Parameter and Note 1, Table 2.....	9
Changes to Timing Diagrams Section, Figure 3 Caption, and Figure 4 Caption.....	9
Added Figure 5, Renumbered Sequentially.....	10
Changes to SPI Block Write Mode Section.....	10
Changed SPI Write All Mode Section to SPI Write/Read All Mode Section.....	10
Changes to SPI Write/Read All Mode Section.....	10
Added Note 1, Table 3.....	11
Changes to Thermal Resistance Section and Table 4.....	11
Changes to Figure 9 and Table 5.....	12
Changes to Typical Performance Characteristics Section.....	15
Added Equivalent Circuits Section.....	27
Moved Figure 10 to Figure 16.....	27
Changes to RF Path Section.....	28
Added Digital Interface Section and Figure 90.....	28
Changes to Phase and Gain Control Section.....	29
Added Receive Output Noise and Noise Figure Section.....	29
Moved Transmit and Receive Control Section.....	29
Added RF Subcircuit Enables and Disables Section.....	30

TABLE OF CONTENTS

Changes to Table 6.....	30
Added Figure 93 and Figure 94.....	30
Changes to Power Detectors Section.....	31
Moved Figure 94.....	31
Changed External Amplifier Bias DACs Section to External Amplifier Bias Drivers Section.....	31
Changes to External Amplifier Bias Drivers Section.....	31
Moved Figure 95.....	31
Changes to External Switch Control Section.....	31
Moved Figure 96 and Figure 97.....	31
Changes to ADC Operation Section.....	32
Added Table 7, Renumbered Sequentially.....	32
Changes to Chip Addressing Section.....	32
Changes to Memory Access Section.....	32
Added Single Memory Fetch Section.....	32
Added Bias Setting Memory Fetch Section.....	33
Added Sequencing Through Memory Beam Positions Section.....	33
Added Toggling Between RAM and Registers Section.....	33
Added Memory Counter Attributes Section.....	34
Added Memory Address Decoding Section and Table 8.....	34
Deleted Table 8 to Table 12.....	34
Added Memory Map Section.....	34
Changes to Gain Control Registers Section.....	35
Changes to Switched Attenuator Control Section and Table 8.....	35
Changes to Phase Control Registers Section and Table 9.....	36
Changes to Transmit and Receive Subcircuit Control Section.....	37
Changed TR_SOURCE = 0 (SPI Control) Section to SPI Control (TR_SOURCE = 0) Section.....	37
Changed TR_SOURCE = 1 (TR Pin Control) Section to TR Pin Control (TR_SOURCE = 1) Section.....	37
Changes to Transmit and Receive Switch Driver Control Section and Table 13.....	38
Changes to PA Bias Output Control Section.....	39
Added Table 15.....	39
Moved Table 16.....	39
Changes to LNA Bias Output Control Section and Table 18.....	40
Added Table 17.....	40
Added PA Bias, LNA Bias, and Switch Bias Setup Examples Section.....	41
Added PA Bias Setup for TR Pin Control Example Section and Table 19.....	41
Added PA Bias Setup for SPI Control Example Section and Table 20.....	41
Added LNA Bias Setup for TR Pin Control Example Section and Table 21.....	41
Added LNA Bias Setup for SPI Control Example Section and Table 22.....	42
Added Allowable PA and LNA States While in SPI Control Section and Table 23.....	42
Added Switch Bias Setup for TR Control Example Section and Table 24.....	42
Added Switch Bias Setup for SPI Control Example Section and Table 25.....	42
Changes to Transmit/Receive Delay Control Section.....	43
Added PA Bias Silicon Error When Using Delay Section.....	43
Added ADAR1000 and ADTR1107 Section.....	44
Added Interfacing Section.....	44
Added Supply and Bias Sequencing Section and Figure 97.....	44
Added Setting the ADAR1000 TR_SW_POS Section.....	45
Added Setting the ADAR1000 PA_BIASx Pins Section.....	45
Added Setting the ADAR1000 LNA_BIAS Pin Section.....	45

TABLE OF CONTENTS

Moved Powering the ADAR1000 Section.....	45
Changes to Figure 98 Caption to Figure 101 Caption.....	45
Added Return Loss While Powered Down Section and Figure 103 to Figure 105.....	47
Added SPI Considerations Section and Table 27.....	47
Added Register 0x00 Section.....	47
Added SDO Readback Problem and Solution Section, Table 28, and Table 29.....	48
Added SDO Bus Connections Section and Figure 106.....	49
Changes to Table 30 and Note 1, Table 31.....	50
Changes to Table 32.....	53
Changes to Register Descriptions Section.....	57
Deleted Table 26.....	57
Changes to Table 43 to Table 46.....	60
Changes to Table 55 to Table 58.....	63
Changes to Table 67.....	66
Changes to Table 76 and Table 77.....	69
Changes to Table 83.....	72
Changes to Table 108.....	78

SPECIFICATIONS

AVDD1 = -5 V, AVDD3 = +3.3 V, $T_A = 25^\circ\text{C}$, and the device is programmed to the maximum channel gain and the nominal bias conditions on all channels, unless otherwise noted. Nominal bias register settings: Register 0x034 = 0x08, Register 0x035 = 0x55, Register 0x036 = 0x2D, and Register 0x37 = 0x06. Low power bias register settings: Register 0x034 = 0x05, Register 0x035 = 0x1A, Register 0x036 = 0x2A, and Register 0x37 = 0x03.

Table 1.

Parameter	Test Conditions/Comments	Min	Typ	Max	Unit
OPERATING CONDITIONS					
RF Range		8		16	GHz
Operating Temperature		-40		+85	$^\circ\text{C}$
TRANSMIT SECTION					
	RF_IO, TX1, TX2, TX3, and TX4 pins				
Maximum Single Channel Gain ¹					
9.5 GHz			21		dB
11.5 GHz			19		dB
14 GHz			16		dB
Gain Flatness vs. Frequency	Across any 1 GHz bandwidth				dB
	From 9 GHz to 14 GHz		± 1.0		dB
	From 8 GHz to 15 GHz		± 1.7		dB
Gain Variation vs. Temperature	11.5 GHz		± 2.5		dB
Output 1 dB Compression (P1dB)	Maximum gain setting				
Nominal Bias Setting					
9.5 GHz			10		dBm
11.5 GHz			10		dBm
14 GHz			10		dBm
Low Bias Setting					
9.5 GHz			6		dBm
11.5 GHz			8		dBm
14 GHz			7		dBm
Saturated Power (P_{SAT})	Maximum gain setting				
Nominal Bias Setting					
9.5 GHz			14		dBm
11.5 GHz			14		dBm
14 GHz			13		dBm
Low Bias Setting					
9.5 GHz			14		dBm
11.5 GHz			14		dBm
14 GHz			13		dBm
Gain Resolution			≤ 0.5		dB
Root Mean Square (RMS) Gain Error	Over phase settings and frequencies		0.2		dB
Phase Adjustment Range			360		Degrees
Phase Resolution			2.8		Degrees
RMS Phase Error	Over phase settings and frequencies		2		Degrees
Noise Figure	Maximum gain setting				
Nominal Bias Setting					
9.5 GHz			22		dB
11.5 GHz			23		dB
14 GHz			25		dB
Low Bias Setting					
9.5 GHz			22		dB
11.5 GHz			23		dB
14 GHz			25		dB

SPECIFICATIONS

Table 1.

Parameter	Test Conditions/Comments	Min	Typ	Max	Unit
Channel to Channel Isolation ²			-40		dB
Transmit Output to RF_IO	Maximum gain setting, 9.5 GHz		-60		dB
Output Return Loss	TX1, TX2, TX3, or TX4 pin		-10		dB
Input Return Loss	RF_IO pin		-12		dB
Output Third-Order Intercept (IP3)	Maximum gain setting, 1 MHz carrier spacing				
Nominal Bias Setting					
9.5 GHz			20		dBm
11.5 GHz			21		dBm
14 GHz			22		dBm
Low Bias Setting					
9.5 GHz			15		dBm
11.5 GHz			16		dBm
14 GHz			16		dBm
RECEIVE SECTION					
Maximum Single Channel Gain ³	Nominal bias setting				
9.5 GHz			10		dB
11.5 GHz			9		dB
14 GHz			7		dB
Maximum Electronic Gain ⁴	Nominal bias setting				
9.5 GHz			16		dB
11.5 GHz			15		dB
14 GHz			13		dB
Maximum Coherent Gain ⁵	Nominal bias setting				
9.5 GHz			22		dB
11.5 GHz			21		dB
14 GHz			19		dB
Gain Flatness	Across any 1 GHz bandwidth				
	From 9 GHz to 14 GHz		±1.0		dB
	From 8 GHz to 15 GHz		±1.7		dB
Gain Variation vs. Temperature	11.5 GHz		±3		dB
Input P1dB	Unmeasured paths enabled and terminated with 50 Ω				
Nominal Bias Setting					
9.5 GHz			-16		dBm
11.5 GHz			-16		dBm
14 GHz			-15		dBm
Low Bias Setting					
9.5 GHz			-13		dBm
11.5 GHz			-12		dBm
14 GHz			-10		dBm
Input IP3	Maximum gain setting, carrier spacing 1 MHz; unmeasured paths enabled and terminated with 50 Ω				
Nominal Bias Setting					
9.5 GHz			-7		dBm
11.5 GHz			-7		dBm
14 GHz			-6		dBm
Low Bias Setting					
9.5 GHz			-7		dBm

SPECIFICATIONS

Table 1.

Parameter	Test Conditions/Comments	Min	Typ	Max	Unit
11.5 GHz			-6		dBm
14 GHz			-5		dBm
Gain Adjustment Range	Variable gain amplifier (VGA) and step attenuator		≥31		dB
Gain Resolution			≤0.5		dB
RMS Gain Error			0.2		dB
Phase Adjustment Range			360		Degrees
Phase Resolution			2.8		Degrees
RMS Phase Error			2		Degrees
Noise Figure	Maximum gain setting; unmeasured paths disabled and terminated with 50 Ω				
Nominal Bias Setting					
9.5 GHz			8		dB
11.5 GHz			8		dB
14 GHz			9		dB
Low Bias Setting					
9.5 GHz			9		dB
11.5 GHz			10		dB
14 GHz			11		dB
Channel to Channel Isolation ⁶			40		dB
RF_IO to Receive Isolation			60		dB
Input Return Loss			-10		dB
Output Return Loss	RF_IO pin		-12		dB
TEMPERATURE SENSOR					
Range		-40		+85	°C
Slope			0.8		LSB/°C
Nominal Analog-to-Digital Converter (ADC) Output	Power-on reset (POR) mode (transmit and receive not enabled), T _A = 25°C		145		Decimal
Resolution			8		Bits
TRANSMIT AND RECEIVE SWITCHING					
Transmit and Receive Switching Time	TX_LOAD, RX_LOAD, and TR pins From rising/falling edge of TR at 50% to RF at 90%		180		ns
Phase and Gain Switching Time	From rising edge of TX_LOAD or RX_LOAD at 50% to RF at 90%		20		ns
POWER DETECTOR					
RF Input Power Range	DET1, DET2, DET3, and DET4 pins 11.5 GHz	-20		+10	dBm
Input Return Loss			-10		dB
Nominal ADC Output Code	Input power (P _{IN}) = 0 dBm, 11.5 GHz		60		Decimal
Resolution			8		Bits
POWER AMPLIFIER (PA) DIGITAL-TO-ANALOG CONVERTER (DAC)					
Resolution	PA_BIAS1, PA_BIAS2, PA_BIAS3, and PA_BIAS4 pins		8		Bits
Voltage Range			-4.8 to 0		V
Source and Sink Current			-10 to +10		mA
Off to On Switching Time	From TR or CSB at 50% to V _{OUT} at 90%, V _{OUT} from -1 V to -2 V, 1 nF C _{LOAD}		60		ns
On to Off Switching Time	From TR or CSB at 50% to V _{OUT} at 10%, V _{OUT} from -1 V to -2 V, 1 nF C _{LOAD}		60		ns
LOW NOISE AMPLIFIER (LNA) DAC					
Resolution	LNA_BIAS pin		8		Bits

SPECIFICATIONS

Table 1.

Parameter	Test Conditions/Comments	Min	Typ	Max	Unit
Voltage Range			-4.8 to 0		V
Source and Sink Current			-10 to +10		mA
Off to On Switching Time	From TR or CSB at 50% to V_{OUT} at 90%, V_{OUT} from -2 V to -1 V, 1 nF C_{LOAD}		60		ns
On to Off Switching Time	From TR or CSB at 50% to V_{OUT} at 10%, V_{OUT} from -1 V to -2 V, 1 nF C_{LOAD}		60		ns
TRANSMIT AND RECEIVE MODULE CONTROL					
Voltage Range	TR_SW_POS, TR_SW_NEG, TR_POL pins TR_SW_NEG, TR_POL TR_SW_POS		-4.8 to 0 0 to 3.2		V V
Off to On Switching Time	From TR or CSB at 50% to V_{OUT} at 90%		15		ns
On to Off Switching Time	From TR or CSB at 50% to V_{OUT} at 10%		15		ns
LOGIC INPUTS ⁷					
Input High Voltage (V_{IH})	TR, RX_LOAD, TX_LOAD, CSB, SCLK, and SDIO pins	1.0			V
Input Low Voltage (V_{IL})			0.4		V
High and Low Input Current (I_{INH} , I_{INL})			±1		μA
Input Capacitance (C_{IN})			1		pF
LOGIC OUTPUTS					
Output High Voltage (V_{OH})	SDO and SDIO pins Output high current (I_{OH}) = 0 mA (open circuit)		1.8		V
Output Low Voltage (V_{OL})	Output low current (I_{OL}) = 0 mA (open circuit)		0		V
Output High Voltage (V_{OH})	Output high current (I_{OH}) = -10 mA	1.4			V
Output Low Voltage (V_{OL})	Output low current (I_{OL}) = 10 mA			0.4	V
POWER SUPPLIES					
AVDD1		-5.25	-5	-4.75	V
AVDD3		3.1	3.3	3.5	V
I_{AVDD1}	Quiescent (reset state)		-4		mA
I_{AVDD1}	PA bias outputs fully loaded		-50		mA
I_{AVDD3}					
Reset Mode (Standby)			23		mA
Transmit Mode	Four channels enabled, nominal bias		350		mA
	Four channels enabled, low bias setting		240		mA
Receive Mode	Four channels enabled, nominal bias		260		mA
	Four channels enabled, low bias setting		160		mA

¹ Single channel transmit gain defined as the ratio of output power at any Tx output port to the input power applied to the RF_IO port.

² From one transmit channel port to another, both channels must be set to the maximum gain.

³ Single channel receive gain is the ratio of the output power at RF_IO to the input power applied to any single receive port, with the other three receive ports terminated in 50 Ω.

⁴ Electronic gain is the ratio of the output power at RF_IO to the input power applied to any single receive port, with the other three receive ports driven and phased for coherent combining with 6 dB subtracted. The electronic gain is approximately 6 dB higher than the single path gain, and 6 dB lower than coherent gain.

⁵ Coherent gain is the ratio of output power at RF_IO to the input power applied to any single receive port, with the other three receive ports driven and phased for coherent combining.

⁶ From one receive channel port to another, both channels must be set to the maximum gain.

⁷ Inputs have 100 mV (typical) of hysteresis.

TIMING SPECIFICATIONS

AVDD1 = -5 V, AVDD3 = +3.3 V, T_A = 25°C, unless otherwise noted.

SPECIFICATIONS

Table 2. SPI Timing

Parameter	Min	Typ	Max	Unit	Test Conditions/Comments
Maximum Clock Rate (t_{SCLK})		25		MHz	
Minimum Clock Period ($1/t_{SCLK}$) ¹		40		ns	
Minimum Pulse Width High (t_{PWH}) ¹		10		ns	
Minimum Pulse Width Low (t_{PWL}) ¹		10		ns	
Setup Time, SDIO to SCLK (t_{DS})		5		ns	
Hold Time, SDIO to SCLK (t_{DH})		5		ns	
Data Valid, SDO to SCLK (t_{DV})		5		ns	
Setup Time, CSB to SCLK (t_{DCS})		10		ns	
SDIO, SDO Rise Time (t_R)		4		ns	Outputs loaded with 80 pF, 10% to 90%
SDIO, SDO Fall Time (t_F)		4		ns	Outputs loaded with 80 pF, 10% to 90%

¹ Clock Period = (Pulse Width High) + (Pulse Width Low); but (Minimum Clock Period) = (Minimum Pulse Width High) + (Minimum Pulse Width Low). The clock period allows SPI signals that are not 50% duty cycle. If Minimum Pulse Width High = 10 ns, then Minimum Pulse Width Low = 30 ns, or vice versa.

Timing Diagrams

The standard Analog Devices, Inc., SPI transaction is 24 bits in length, although longer SPI transactions are possible. Figure 2 shows a generalized SPI transaction, that is either 24 bits or more (in additional 8-bit increments). See the [SPI Block Write Mode](#) section for more details on longer than 24-bit SPI transactions. All timing diagrams show MSB clocked in first. In a 24-bit SPI transaction, the data is latched into the ADAR1000 on the SCLK rising edge of the last data bit clocked in (D_LSB).

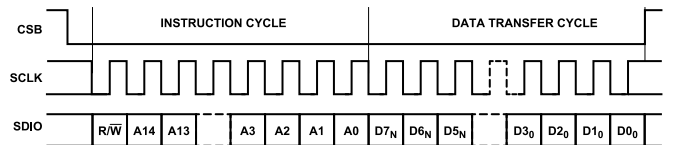

Figure 2. Serial Port Interface Register Timing (MSB First)

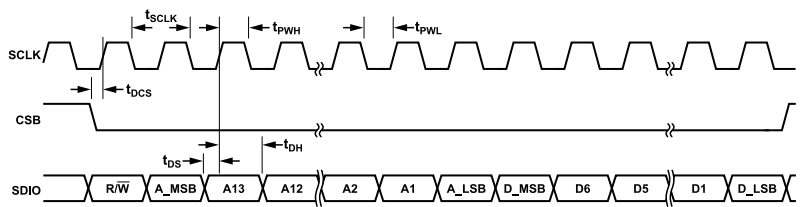

Figure 3. Timing Diagram for 4-Wire or 3-Wire Serial Port Interface Register Write

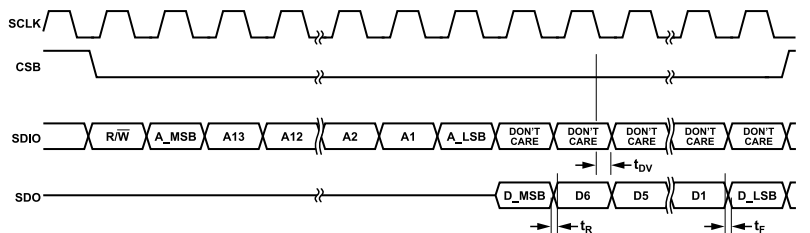

Figure 4. Timing Diagram for 4-Wire Serial Port Interface Register Read

SPECIFICATIONS

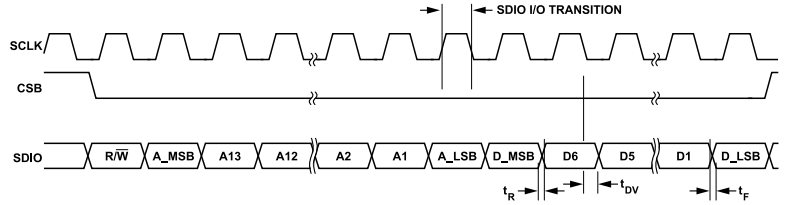

Figure 5. Timing Diagram for 3-Wire Serial Port Interface Register Read

Note that in 3-wire mode, the SDIO pin becomes an output pin after receiving the instruction address header with a readback request. In this mode, the SDIO must be changed from an input to an output in the 1/2 cycle of SCLK between the last rising edge of SCLK of the instruction and the following falling edge.

SPI Block Write Mode

Data can be written to the SPI registers in a block write mode, where the register address automatically increments, and data for consecutive registers can be written without sending new address bits. Data writing can be continued indefinitely until CSB is raised again, ending the write process. Data for each register is latched into the ADAR1000 on the SCLK rising edge of the last data bit, which is shown as D0 in Figure 6.

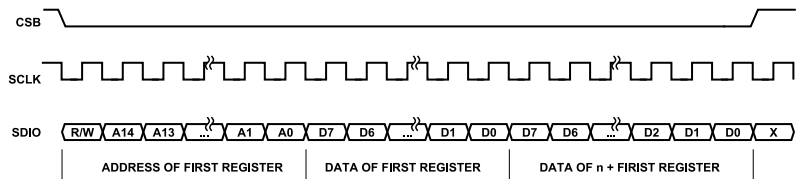

Figure 6. Timing Diagram for Block Write Mode

SPI Write/Read All Mode

Data can be written to the SPI registers in a write all mode, where the data is written to all chips connected to the SPI bus with a single write command, regardless of the ADDR1 and ADDR0 values, by setting address Bits[A14:A11] = 0001. The write all mode allows the user to broadcast the same data, to all ADAR1000 devices sharing the SPI bus, with a single SPI write. If the user has dedicated SDO lines on the PCB, data can be simultaneously read from the SPI registers from several ADAR1000 devices in the read all mode. This mode is initiated by setting Bits[A14:A11] = 0001, and setting the R/W bit = 1 for a read all. Note that this write or read all capability is only applicable to the registers, and not applicable to the random access memory (RAM) space. The RAM space is accessed when Bit 12 = 1. The user must consider the chip ID bits, Bits[14:13], when writing data to the RAM.

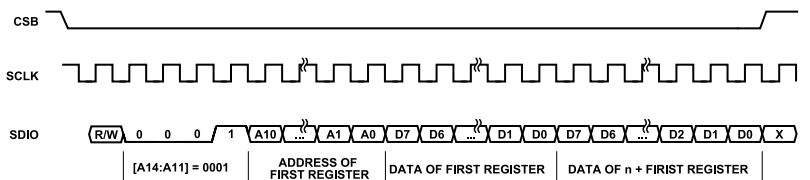

Figure 7. SPI Write All Instruction and Timing Diagram

ABSOLUTE MAXIMUM RATINGS

Table 3.

Parameter	Rating
AVDD1 to GND	-5.5 V
AVDD3 to GND	3.6 V
Digital Input/Output Voltage to GND	2.0 V
Maximum RF Input Power ¹	20 dBm
Operating Temperature Range	-40°C to +85°C
Storage Temperature Range	-65°C to +150°C
Reflow Soldering	
Peak Temperature	260°C
Junction Temperature (T _J)	135°C
Electrostatic Discharge (ESD)	
Charged Device Model (CDM)	±500 V
Human Body Model (HBM)	±2500 V

¹ Applicable to any receive or transmit input.

Stresses at or above those listed under Absolute Maximum Ratings may cause permanent damage to the product. This is a stress rating only; functional operation of the product at these or any other conditions above those indicated in the operational section of this specification is not implied. Operation beyond the maximum operating conditions for extended periods may affect product reliability.

THERMAL RESISTANCE

Thermal performance is directly linked to printed circuit board (PCB) design and operating environment. The PCB thermal design requires careful attention.

θ_{JA} is the junction to the ambient with the exposed pad soldered down, θ_{JC-TOP} is the junction to the top of the package, and $\theta_{JC-BOTTOM}$ is the junction to the exposed pad on the bottom of the package.

Table 4. Thermal Resistance

Package Type	θ_{JA}	θ_{JC-TOP}	$\theta_{JC-BOTTOM}$	Unit
CC-88-1 ¹	18.7	9.7 ²	10.1	°C/W

¹ Simulated based on PCB specified in JESD-51.

² Simulated with cold plate attached on top of the package using 100 μm of thermal interface material (3.6 W/mK).

ESD CAUTION



ESD (electrostatic discharge) sensitive device. Charged devices and circuit boards can discharge without detection. Although this product features patented or proprietary protection circuitry, damage may occur on devices subjected to high energy ESD. Therefore, proper ESD precautions should be taken to avoid performance degradation or loss of functionality.

PIN CONFIGURATION AND FUNCTION DESCRIPTIONS

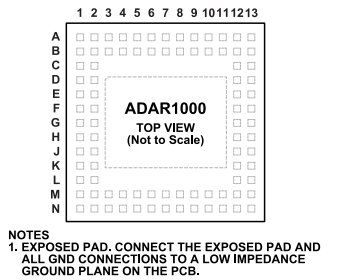

Figure 8. Pin Configuration (Top View)

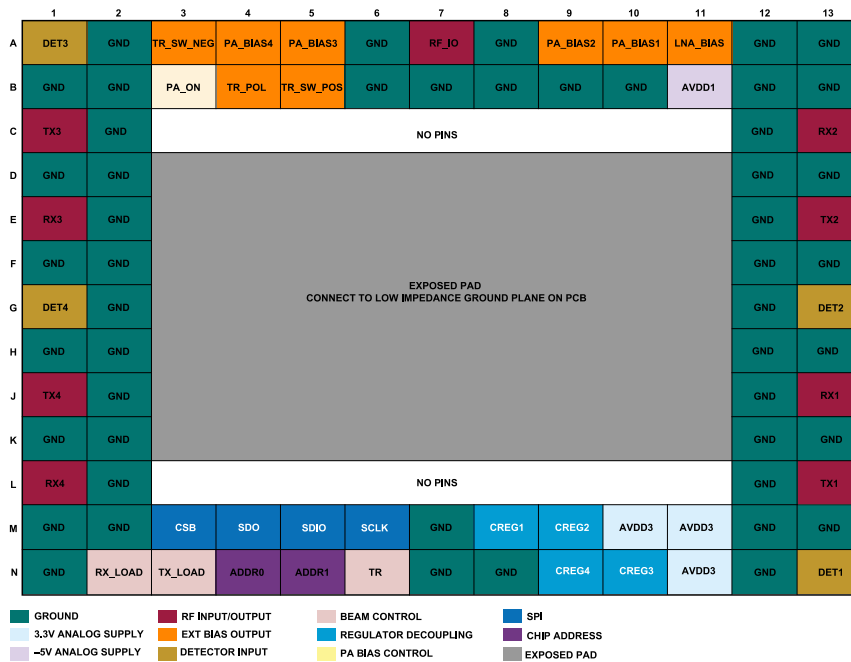

Figure 9. Pin Configuration, Color Coded (Top View)

Table 5. Pin Function Descriptions

Pin No.	Mnemonic	Description
A1	DET3	Channel 3 Power Detector Input. DET3 is internally ac-coupled and enabled by Register 0x030, Bit 1. The nominal operating input power range is -20 dBm to +10 dBm. If this pin is unused, it is recommended to leave the detector disabled and either provide a 50 Ω termination or ground the input.
A2, A6, A8, A12, A13, B1, B2, B6 to B10, B12, B13, C2, C12, D1, D2, D12, D13, E2, E12, F1, F2, F12, F13, G2, G12, H1, H2, H12, H13, J2, J12, K1, K2, K12, K13, L2, L12, M1, M2, M7, M12, M13, N1, N7, N8, N12	GND	RF Ground. Tie all ground pins together to a low impedance plane on the PCB board.
A3	TR_SW_NEG	Gate Control Output for External Transmit and Receive Switch (0 V or -5 V). Pin is floating upon power up or after a soft reset.
A4	PA_BIAS4	Gate Bias Output for Channel 4 External PA. Output ranges from 0 to -4.8 V, controlled by a combination of the PA_ON pin, Register 0x02C (CH4_PA_BIAS_ON value), and Register 0x049 (CH4_PA_BIAS_OFF value). Output is set to the CH4_PA_BIAS_OFF value if the PA_ON pin is at logic low. Pin assumes CH4_PA_BIAS_ON default value upon power up or soft reset.
A5	PA_BIAS3	Gate Bias Output for Channel 3 External PA. Output ranges from 0 to -4.8 V, controlled by a combination of the PA_ON pin, Register 0x02B (CH3_PA_BIAS_ON value), and Register 0x048 (CH3_PA_BIAS_OFF value).

PIN CONFIGURATION AND FUNCTION DESCRIPTIONS

Table 5. Pin Function Descriptions

Pin No.	Mnemonic	Description
A7	RF_IO	Output is set to the CH3_PA_BIAS_OFF value if the PA_ON pin is at logic low. Pin assumes CH3_PA_BIAS_ON default value upon power up or soft reset. Common RF Pin for Input in Transmit Mode and Output in Receive Mode. The signal path is ac-coupled via an on-chip capacitor. The dc bias is 0 V due to the on-chip shunt inductor.
A9	PA_BIAS2	Gate Bias Output for Channel 2 External PA. Output ranges from 0 to -4.8 V, controlled by a combination of the PA_ON pin, Register 0x02A (CH2_PA_BIAS_ON value), and Register 0x047 (CH2_PA_BIAS_OFF value). Output is set to the CH2_PA_BIAS_OFF value if the PA_ON pin is at logic low. Pin assumes CH2_PA_BIAS_ON default value upon power up or soft reset.
A10	PA_BIAS1	Gate Bias Output for Channel 1 External PA. Output ranges from 0 to -4.8 V, controlled by a combination of the PA_ON pin, Register 0x029 (CH1_PA_BIAS_ON value), and Register 0x046 (CH1_PA_BIAS_OFF value). Output is set to the CH1_PA_BIAS_OFF value if the PA_ON pin is at logic low. Pin assumes CH1_PA_BIAS_ON default value upon power up or soft reset.
A11	LNA_BIAS	Gate Bias Output for External LNA. Output ranges from 0 to -4.8 V, controlled by a combination of Register 0x030 (Bit 4, LNA_BIAS_OUT_EN), Register 0x02D (LNA_BIAS_ON value), and Register 0x04A (LNA_BIAS_OFF value). Output floats if Register 0x030, Bit 4 is at logic low. Pin is floating upon power up or after a soft reset.
B3	PA_ON	PA Enable Input. This pin is used when device transmit/receive operation is controlled via the TR pin. This pin is not used with SPI control. When BIAS_CTRL (Bit 6 in Register 0x30) = 1 and TR_SOURCE (Bit 2 in Register 0x31) = 1, set this pin to logic high for the PA bias voltage outputs to assume the values set by the EXT_PAx_BIAS_ON registers when the TR pin = 1, and EXT_PAx_BIAS_OFF registers when the TR pin = 0 (where x = 1 to 4). All PA bias voltage outputs assume the corresponding EXT_PAx_BIAS_OFF register values if the PA_ON pin is at logic low (see Table 16). This pin is internally pulled up to the 1.8 V low dropout (LDO) regulator bias voltage with a 100 k Ω resistor.
B4	TR_POL	Gate Control Output for External Polarization Switch (0 V or -5 V).
B5	TR_SW_POS	Gate Control Positive Output for External Transmit and Receive Switch (0 V or 3.3 V). Pin is floating upon power up or after a soft reset.
B11	AVDD1	-5 V Power Supply. AVDD1 provides the negative currents for sinking the PA_BIASx and LNA_BIAS outputs. If the PA_BIASx and LNA_BIAS pins are not used, the user can connect AVDD1 to ground to reduce power consumption and to use a single voltage supply. It is recommended to power up the AVDD3 pins (3.3 V) before or at the same time as the AVDD1 pin (-5 V).
C1	TX3	Channel 3 Output in Transmit Mode. This pin is ac-coupled via an on-chip balun and series capacitor.
C13	RX2	Channel 2 Input in Receive Mode. This pin is ac-coupled via an on-chip balun.
E1	RX3	Channel 3 Input in Receive Mode. This pin is ac-coupled via an on-chip balun.
E13	TX2	Channel 2 Output in Transmit Mode. This pin is ac-coupled via an on-chip balun and a series capacitor.
G1	DET4	Channel 4 Power Detector Input. DET4 is internally ac-coupled and enabled by Register 0x030, Bit 0. The nominal operating input power range is -20 dBm to +10 dBm. If this pin is unused, it is recommended to leave the detector disabled and either provide a 50 Ω termination or ground the input.
G13	DET2	Channel 2 Power Detector Input. DET2 is internally ac-coupled and enabled by Register 0x030, Bit 2. The nominal operating input power range is -20 dBm to +10 dBm. If this pin is unused, it is recommended to leave the detector disabled and either provide a 50 Ω termination or ground the input.
J1	TX4	Channel 4 Output in Transmit Mode. This pin is ac-coupled via an on-chip balun and a series capacitor.
J13	RX1	Channel 1 Input in Receive Mode. This pin is ac-coupled via an on-chip balun.
L1	RX4	Channel 4 Input in Receive Mode. This pin is ac-coupled via an on-chip balun.
L13	TX1	Channel 1 Output in Transmit Mode. This pin is ac-coupled via an on-chip balun and a series capacitor.
M3	CSB	SPI Chip Select Input (1.8 V CMOS Logic). Serial communication is enabled when CSB goes low. When CSB goes high, serial data is loaded into the register corresponding to the address in the instruction cycle (see Figure 2) in write mode.
M4	SDO	SPI Serial Data Output (1.8 V CMOS Logic). Enabled when SDO ACTIVE Bit = 1. Used in 4-wire SPI protocol. Pin has a readback error when sharing a bus with other chips. See SDO Readback Problem and Solution .
M5	SDIO	SPI Serial Data Input and Output (1.8 V CMOS Logic). 4-wire SPI protocol if SDO ACTIVE Bit = 1; 3-wire SPI protocol when SDO ACTIVE Bit = 0.
M6	SCLK	SPI Serial Clock Input (1.8 V CMOS Logic). In write mode, data is sampled on the rising edge of SCLK. During a read cycle, output data changes at the falling edge of SCLK.

PIN CONFIGURATION AND FUNCTION DESCRIPTIONS

Table 5. Pin Function Descriptions

Pin No.	Mnemonic	Description
M8	CREG1	Decoupling Pin for 1.8 V LDO Reference. Connect a 1 μ F capacitor through a low impedance path from this pin to a ground plane.
M9	CREG2	Decoupling Pin for 2.8 V LDO Output. Connect a 1 μ F capacitor through a low impedance path from this pin to a ground plane.
M10, M11, N11	AVDD3	3.3 V Voltage Power Supply Inputs. It is recommended to power-up these pins before or at the same time as the AVDD1 (-5 V) supply.
N2	RX_LOAD	Load Receive Registers Input (1.8 V CMOS Logic). A rising edge causes contents in the receive channel holding registers to transfer to the working registers. There is no internal pull-down resistor on this pin; pull down to ground if not using pin. Logically OR'ed internally with LDRX_OVERRIDE signal.
N3	TX_LOAD	Load Transmit Registers Input (1.8 V CMOS Logic). A rising edge causes contents in the transmit channel holding registers to transfer to the working registers. There is no internal pull-down resistor on this pin; pull down to ground if not using pin. Logically OR'ed internally with LDTX_OVERRIDE signal.
N4	ADDR0	Address Pin for 2-Bit Chip Address Code. (1.8 V CMOS Logic). Corresponds to Bit 13 in the SPI address header. ADDR1 and ADDR0 together select one of four ADAR1000 chips to accept the serial instructions and data.
N5	ADDR1	Address Pin for 2-Bit Chip Address Code (1.8 V CMOS Logic). Corresponds to Bit 14 in the SPI address header. ADDR1 and ADDR0 together select one of four core chips to accept the serial instructions and data.
N6	TR	Transmit and Receive Mode Select Input (1.8 V CMOS Logic). TR = Low is receive mode and TR = High is transmit mode.
N9	CREG4	Decoupling Pin for 1.8 V LDO Output. Connect a 1 μ F capacitor through a low impedance path from this pin to a ground plane.
N10	CREG3	Decoupling Pin for 2.8 V LDO Reference. Connect a 1 μ F capacitor through a low impedance path from this pin to a ground plane.
N13	DET1	Channel 1 Power Detector Input. DET1 is internally ac-coupled and enabled by Register 0x030, Bit 3. The nominal operating input power range is -20 dBm to +10 dBm. If this pin is unused, it is recommended to leave the detector disabled and either provide a 50 Ω termination or ground the input.
	EPAD	Exposed Pad. Connect the exposed pad and all GND connections to a low impedance ground plane on the PCB.

TYPICAL PERFORMANCE CHARACTERISTICS

AVDD1 = -5 V, ADVDD3 = +3.3 V, T_A = 25°C, nominal bias settings, reported gain, IP3, P1dB and NF were single channel measurements, with unmeasured channels biased up for gain, IP3 and P1dB, while NF measured with the other three channels disabled, unless otherwise stated.

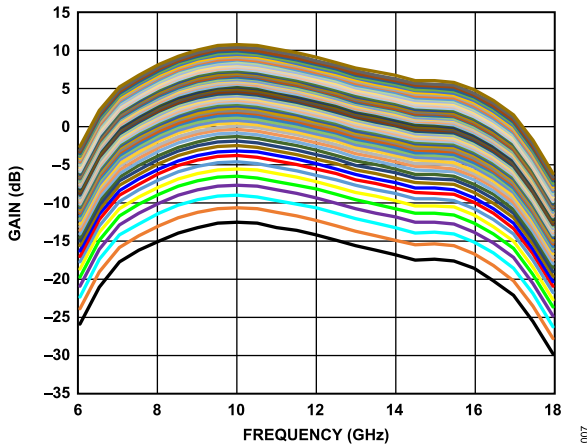

Figure 10. Gain vs. Frequency for Gain Settings from 0 to 127, Single Receive Channel

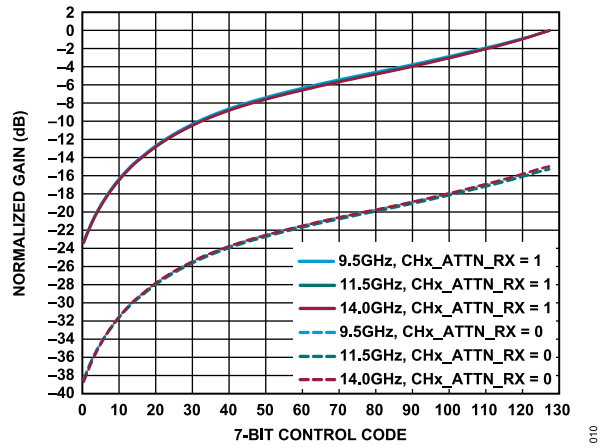

Figure 13. Normalized Gain vs. 7-Bit Gain Control Code, Single Receive Channel

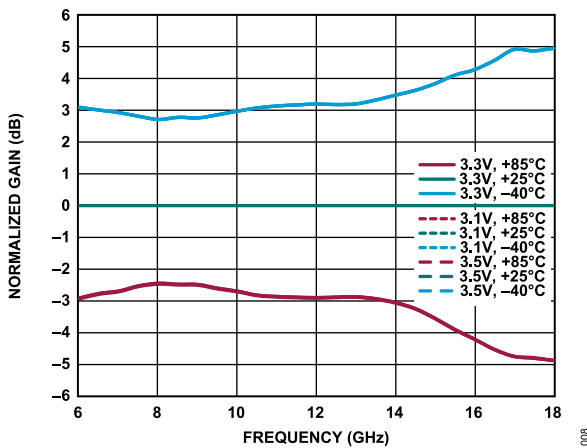

Figure 11. Normalized Gain vs. Frequency over AVDD3 Supply and Temperature, Receive Channel

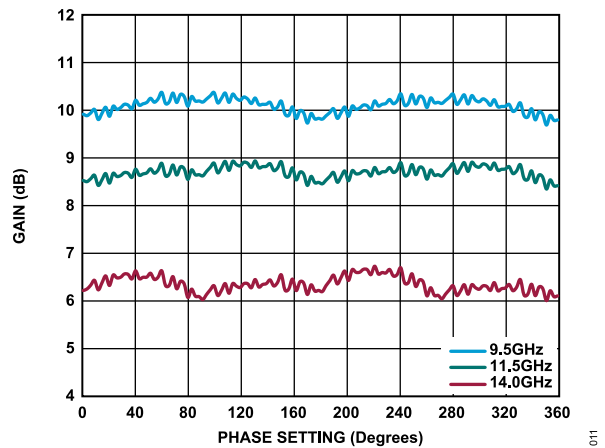

Figure 14. Gain vs. Phase Setting over Frequency, Receive Channel

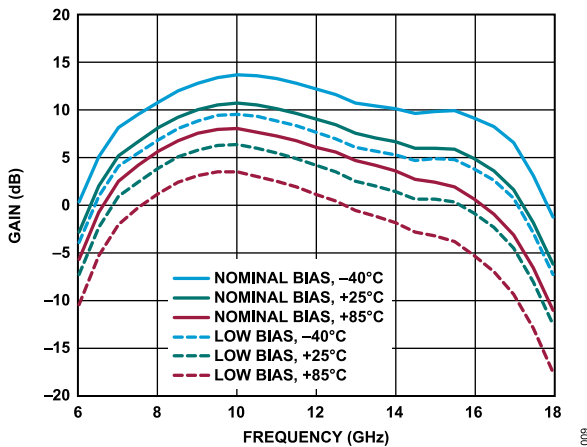

Figure 12. Gain vs. Frequency over Bias and Temperature, Receive Channel

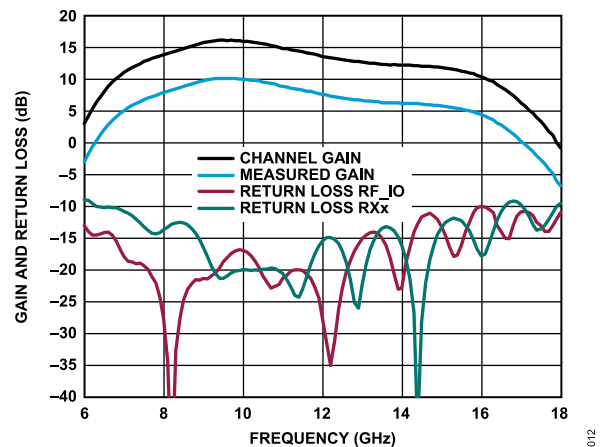

Figure 15. Gain and Return Loss vs. Frequency, at Maximum Gain, Receive Channel

TYPICAL PERFORMANCE CHARACTERISTICS

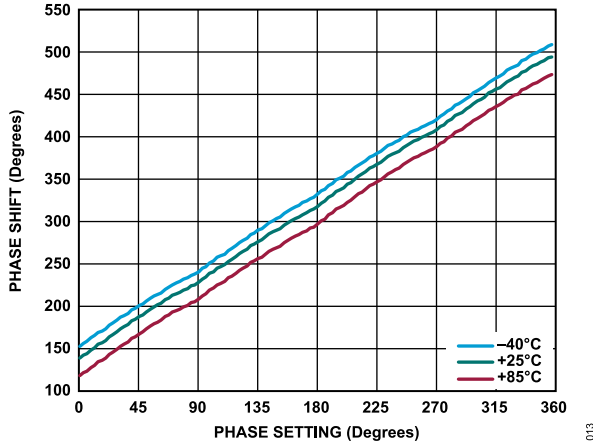

Figure 16. Phase Shift vs. Phase Setting over Temperature, Receive Channel

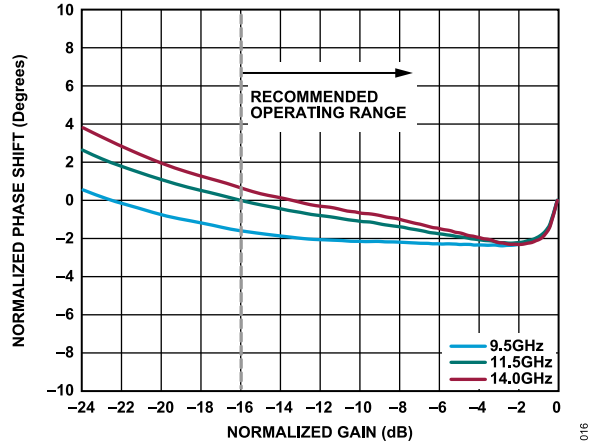

Figure 19. Normalized Phase Shift vs. Normalized Gain over Frequency, Receive Channel

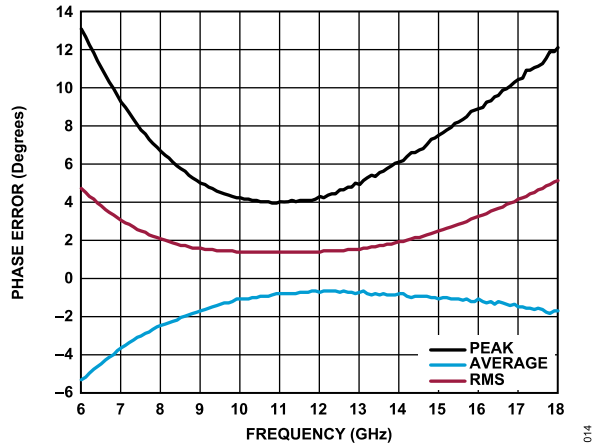

Figure 17. Phase Error vs. Frequency, Receive Channel

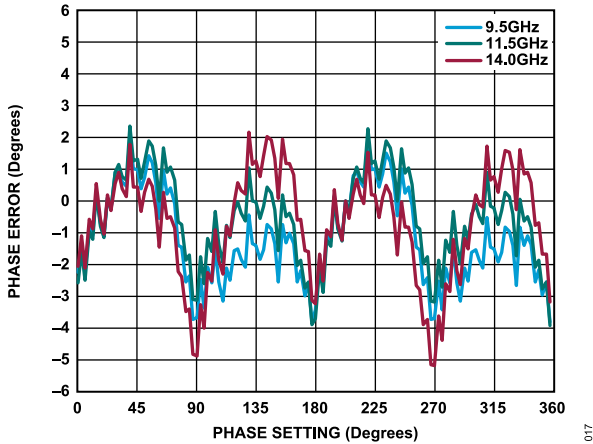

Figure 20. Phase Error vs. Phase Setting over Frequency, Receive Channel

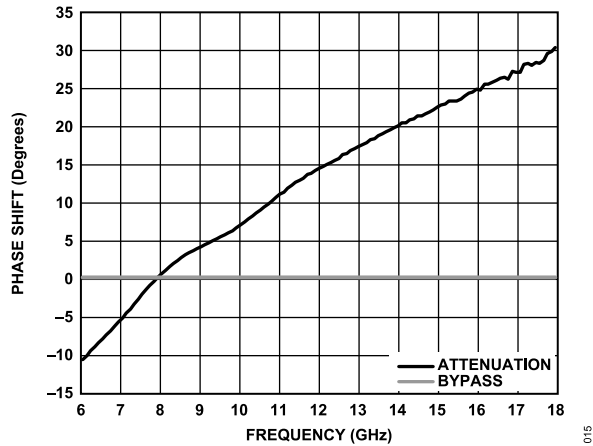

Figure 18. Phase Shift vs. Frequency for Step Attenuator in Attenuation Mode, Normalized to Bypass Mode, Receive Channel

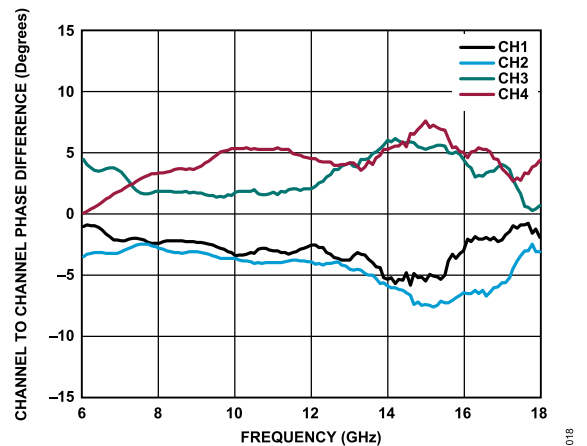

Figure 21. Channel to Channel Phase Difference vs. Frequency, Receive Channel (Referenced to an Average of All Four Channels, Not an Ideal Phase Reference)

TYPICAL PERFORMANCE CHARACTERISTICS

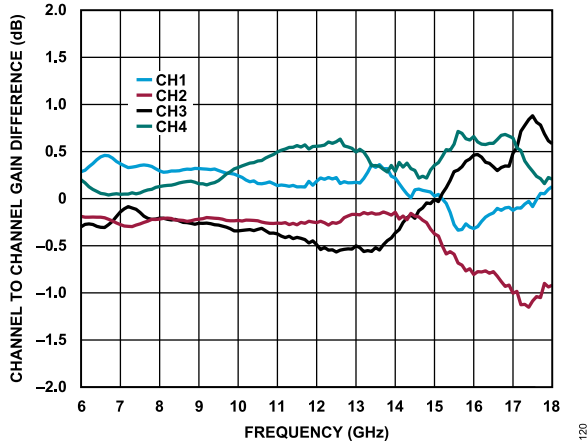

Figure 22. Channel to Channel Gain Difference vs. Frequency, Receive Channel

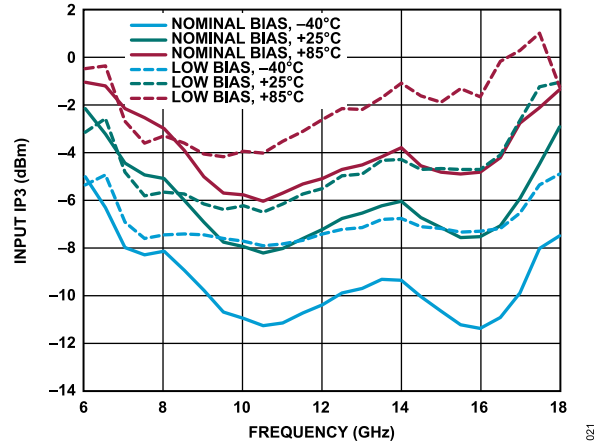

Figure 25. Input IP3 vs. Frequency over Bias and Temperature, Receive Channel

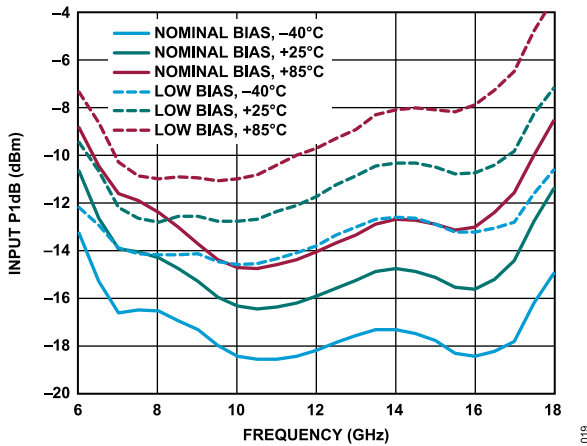

Figure 23. Input P1dB vs. Frequency over Bias and Temperature, Receive Channel

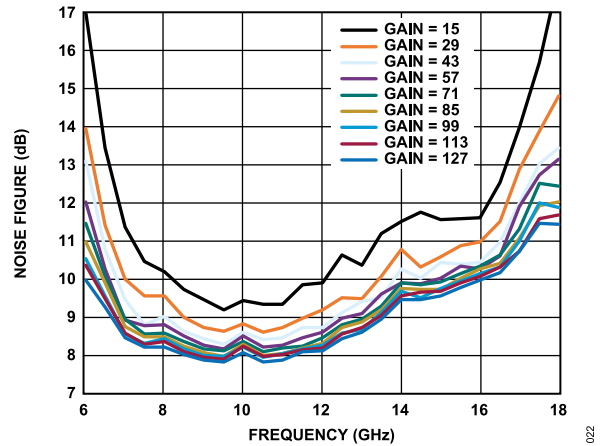

Figure 26. Noise Figure vs. Frequency over Gain, Receive Channel

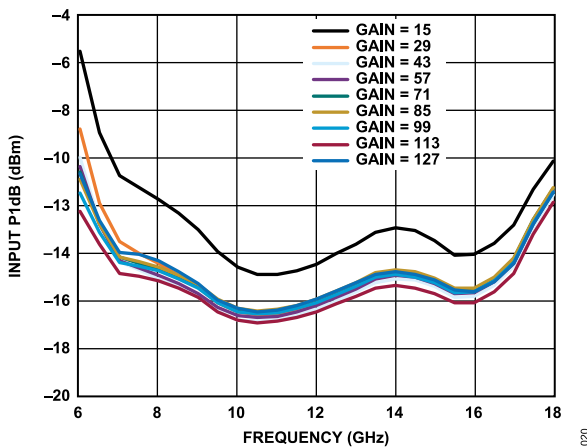

Figure 24. Input P1dB vs. Frequency over Gain, Receive Channel

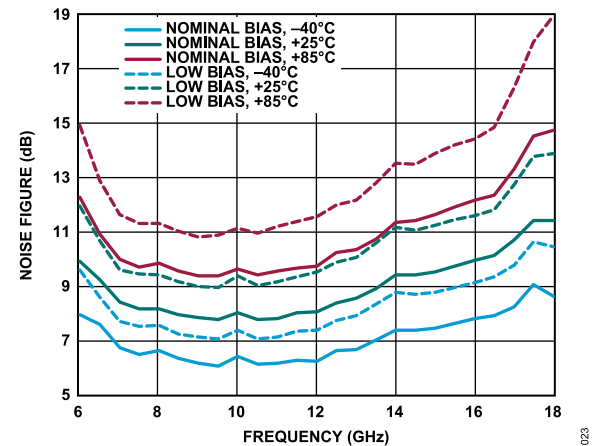

Figure 27. Noise Figure vs. Frequency over Bias and Temperature, Receive Channel

TYPICAL PERFORMANCE CHARACTERISTICS

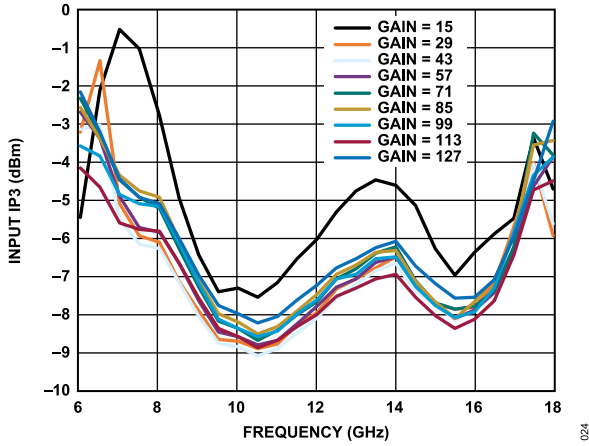

Figure 28. Input IP3 vs. Frequency over Gain, Receive Channel

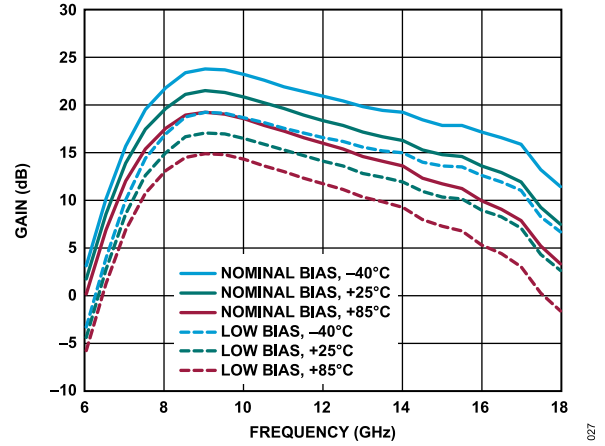

Figure 31. Gain vs. Frequency over Bias and Temperature, Single Transmit Channel

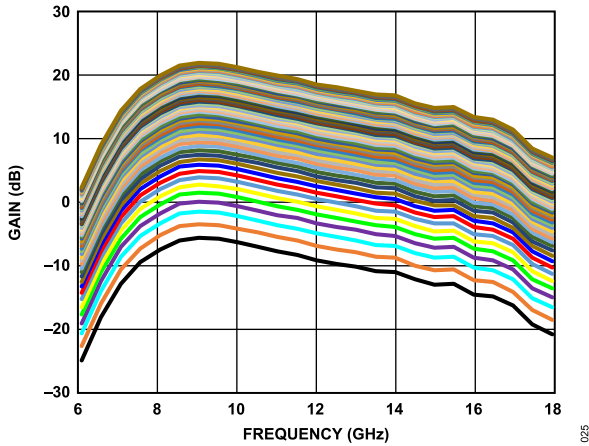

Figure 29. Gain vs. Frequency over Gain Settings from 0 to 127, Single Transmit Channel

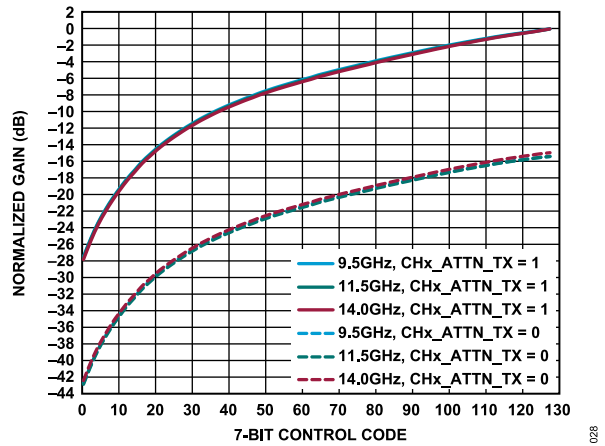

Figure 32. Normalized Gain vs. 7-Bit Gain Control Code, Transmit Channel

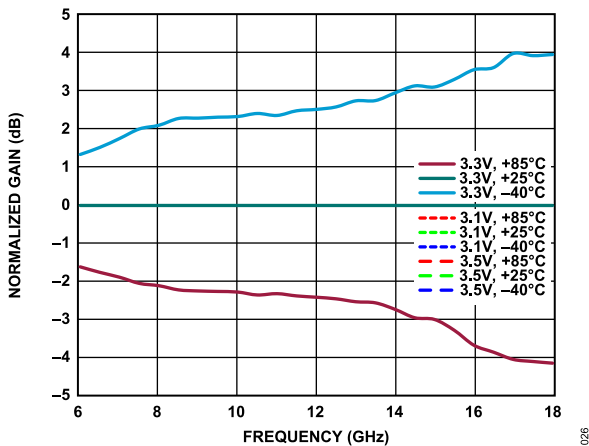

Figure 30. Normalized Gain vs. Frequency over AVDD3 Supply and Temperature, Transmit Channel

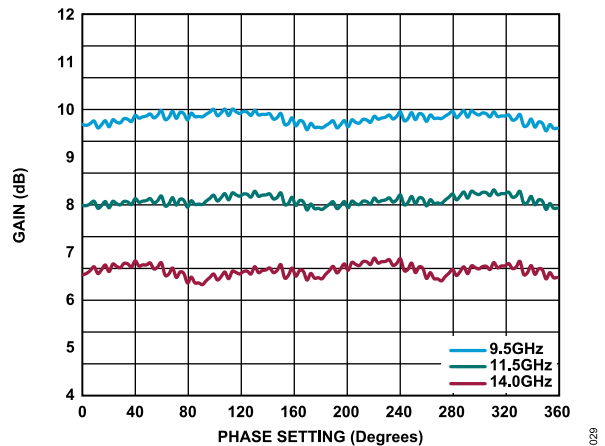

Figure 33. Gain vs. Phase Setting over Frequency, Single Transmit Channel

TYPICAL PERFORMANCE CHARACTERISTICS

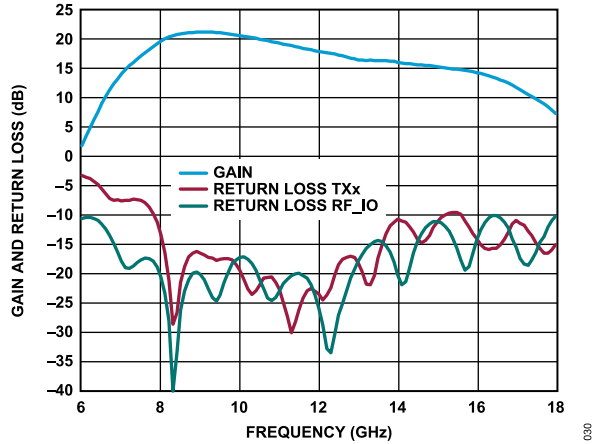

Figure 34. Gain and Return Loss vs. Frequency, Transmit Channel

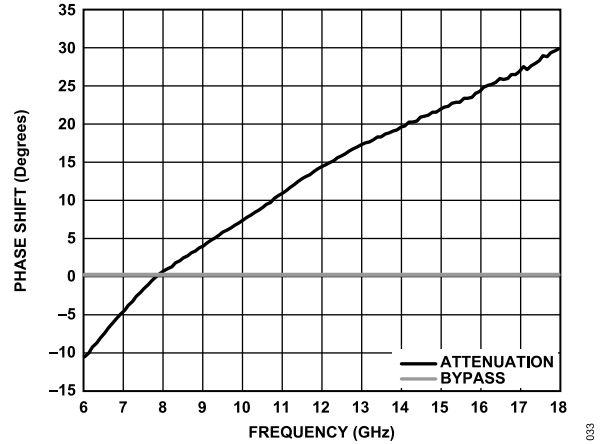

Figure 37. Phase Shift vs. Frequency for Step Attenuator in Attenuation Mode, Normalized to Bypass Mode, Transmit Channel

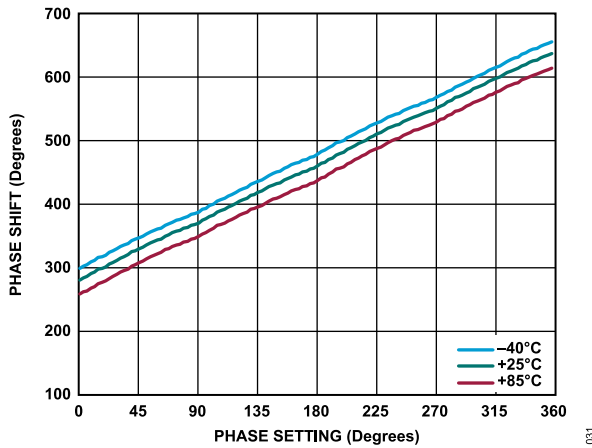

Figure 35. Phase Shift vs. Phase Setting over Temperature, Transmit Channel

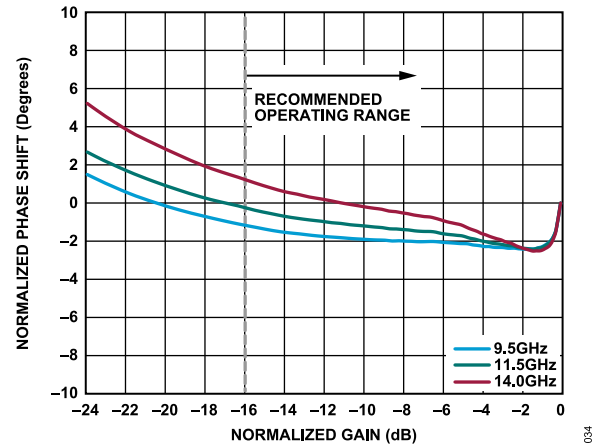

Figure 38. Normalized Phase Shift vs. Normalized Gain over Frequency, Transmit Channel

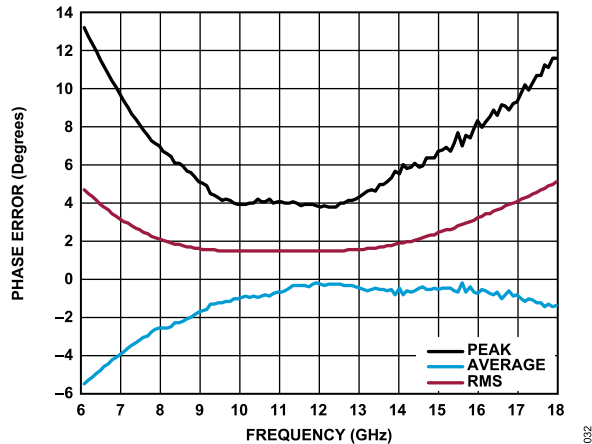

Figure 36. Phase Error vs. Frequency, Transmit Channel

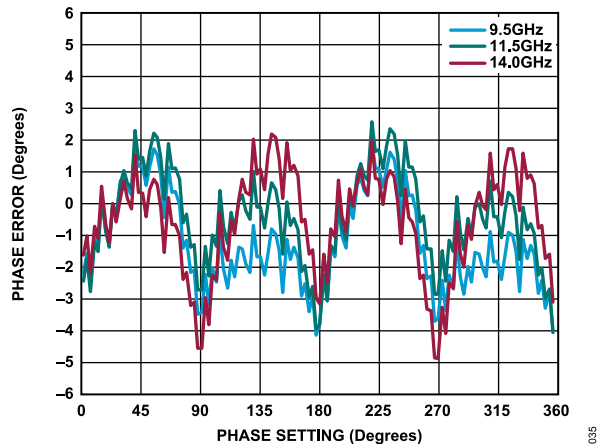

Figure 39. Phase Error vs. Phase Setting over Frequency, Transmit Channel

TYPICAL PERFORMANCE CHARACTERISTICS

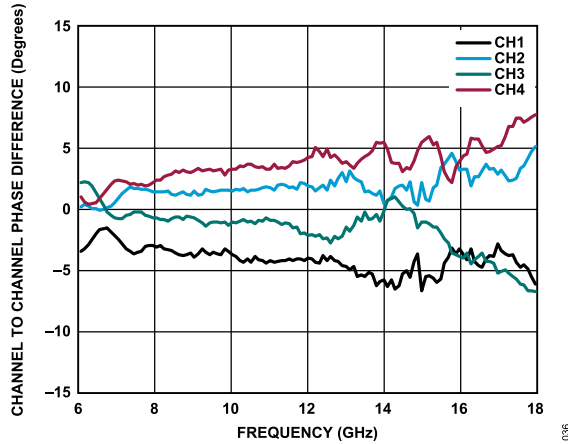

Figure 40. Channel to Channel Phase Difference vs. Frequency, Transmit Channel (Referenced to an Average of All Four Channels, Not an Ideal Phase Reference)

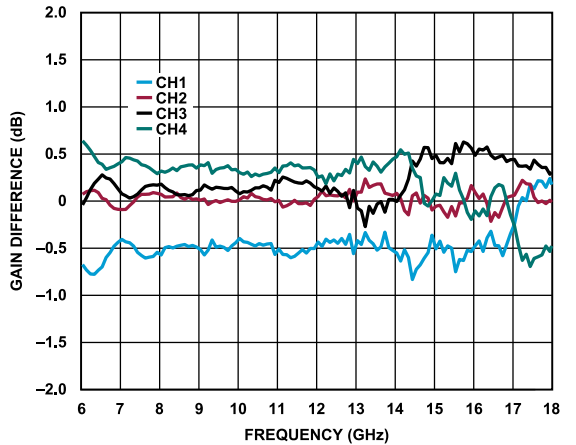

Figure 41. Channel to Channel Gain Difference vs. Frequency, Transmit Channel

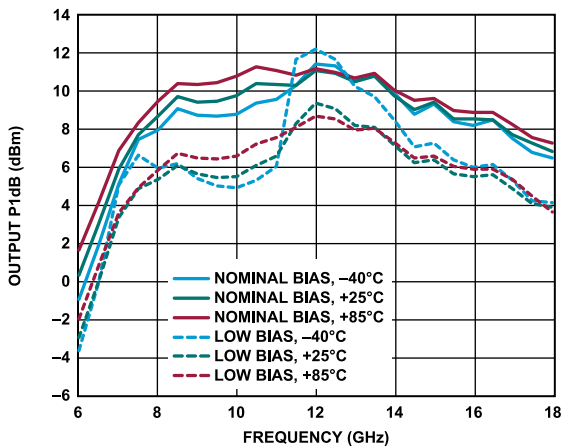

Figure 42. Output P1dB vs. Frequency over Bias and Temperature, Transmit Channel

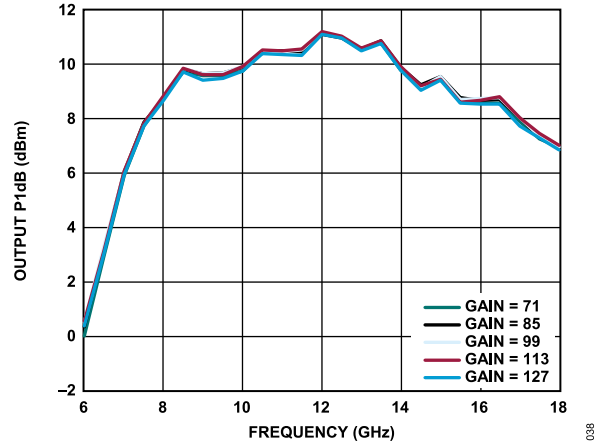

Figure 43. Output P1dB vs. Frequency over Gain, Transmit Channel

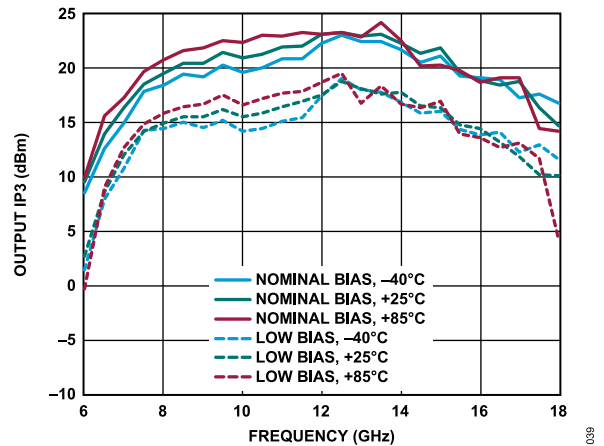

Figure 44. Output IP3 vs. Frequency over Bias and Temperature, Transmit Channel

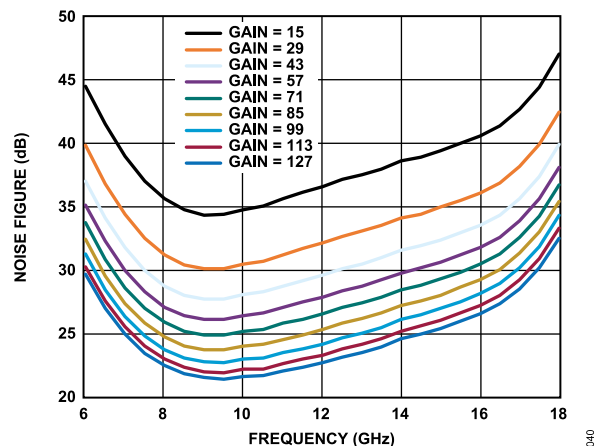

Figure 45. Noise Figure vs. Frequency over Gain, Transmit Channel

TYPICAL PERFORMANCE CHARACTERISTICS

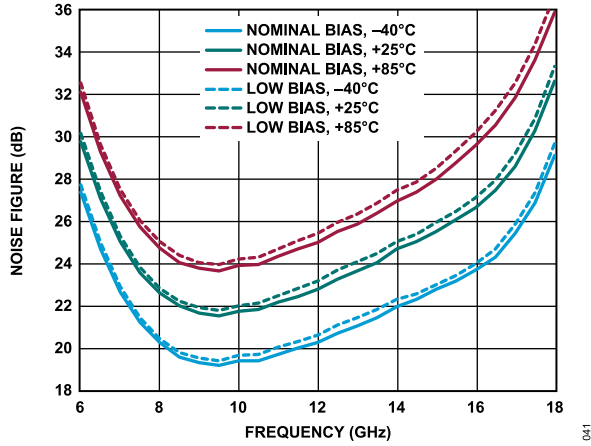

Figure 46. Noise Figure vs. Frequency over Bias and Temperature, Transmit Channel

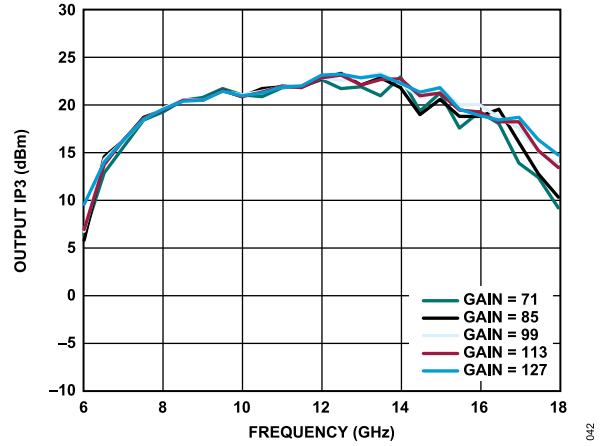

Figure 49. Output IP3 vs. Frequency over Gain, Transmit Channel

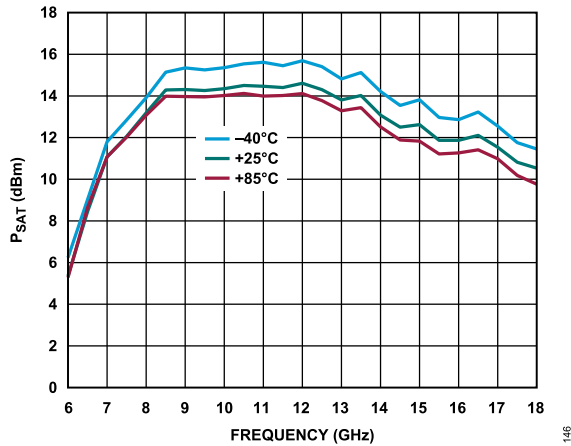

Figure 47. P_{SAT} vs. Frequency, Transmit Channel, Nominal Bias, Maximum Gain and Phase Set to 45°, All Channels Enabled

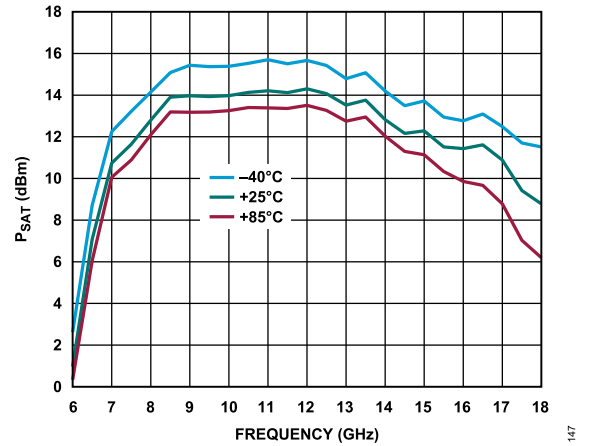

Figure 50. P_{SAT} vs. Frequency, Transmit Channel, Low Bias, Maximum Gain and Phase Set to 45°, All Channels Enabled

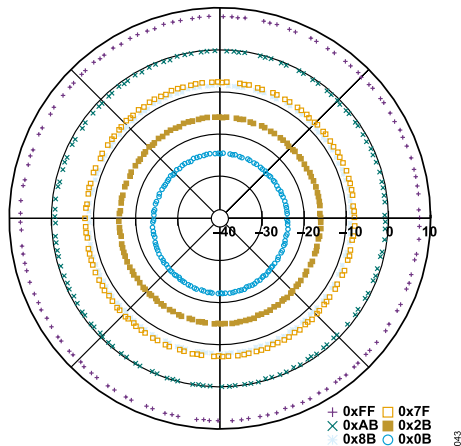

Figure 48. Gain Variation vs. Phase over Gain, 9.5 GHz, Receive Channel

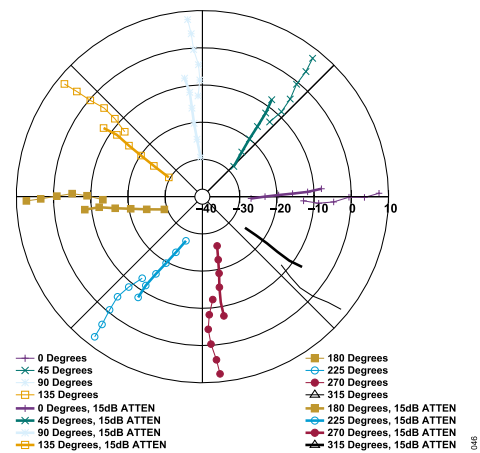

Figure 51. Phase Variation vs. Gain over Phase, 9.5 GHz, Receive Channel; Note the Phase Discontinuity When the Switched Attenuator is Used

TYPICAL PERFORMANCE CHARACTERISTICS

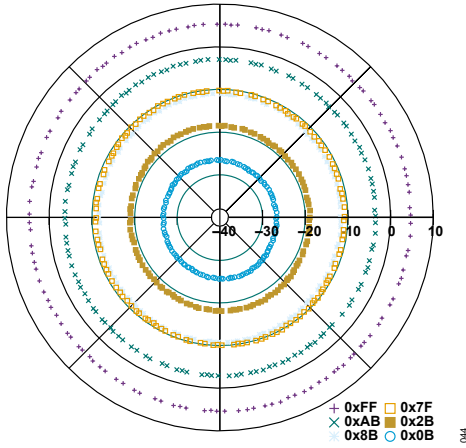

Figure 52. Gain Variation vs. Phase over Gain, 11.5 GHz, Receive Channel

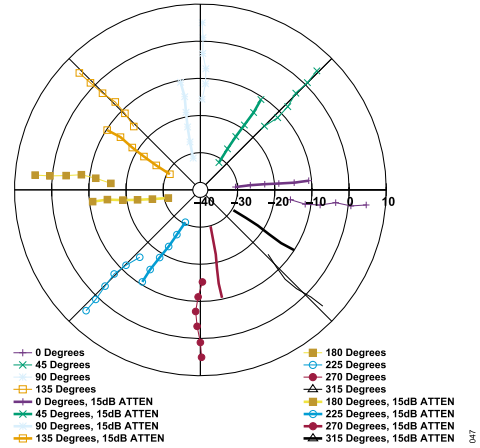

Figure 55. Phase Variation vs. Gain over Phase, 11.5 GHz, Receive Channel

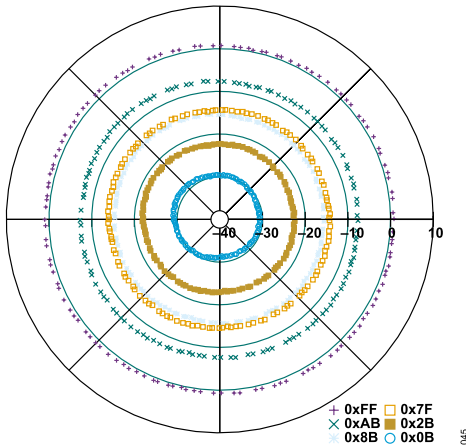

Figure 53. Gain Variation vs. Phase over Gain, 14 GHz, Receive Channel

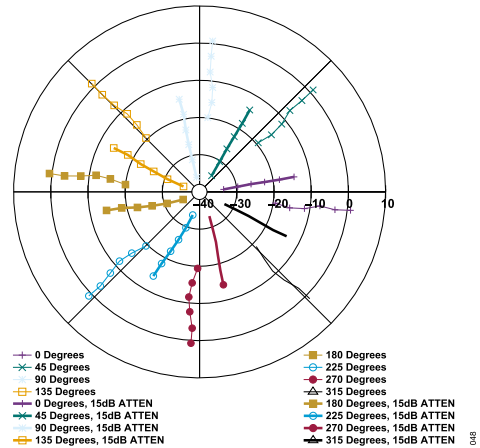

Figure 56. Phase Variation vs. Gain over Phase, 14 GHz, Receive Channel

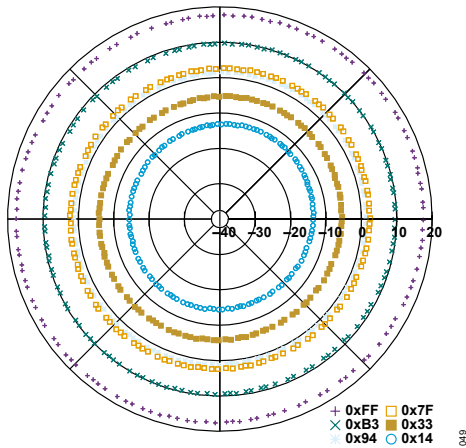

Figure 54. Gain Variation vs. Phase over Gain, 9.5 GHz, Transmit Channel

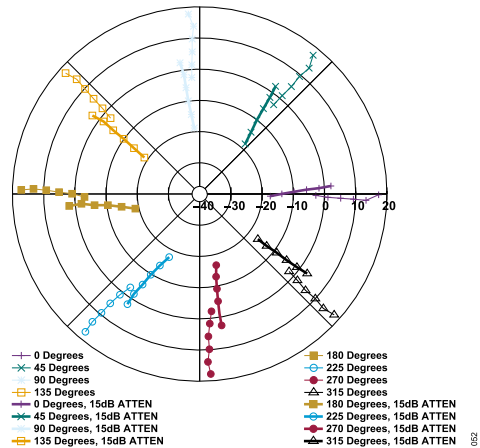

Figure 57. Phase Variation vs. Gain over Phase, 9.5 GHz, Transmit Channel

TYPICAL PERFORMANCE CHARACTERISTICS

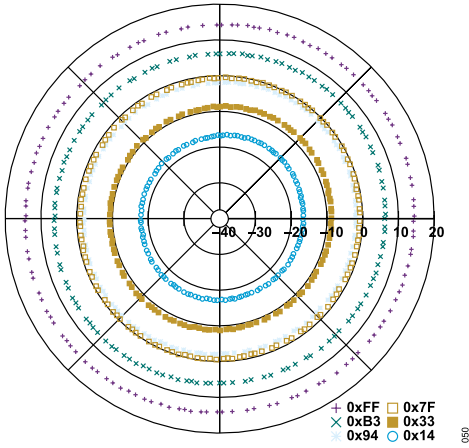

Figure 58. Gain Variation vs. Phase over Gain, 11.5 GHz, Transmit Channel

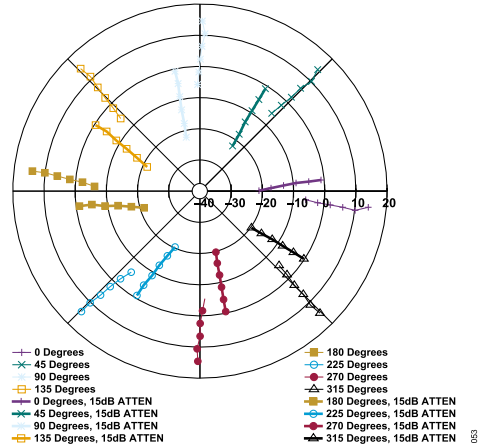

Figure 61. Phase Variation vs. Gain over Phase, 11.5 GHz, Transmit Channel

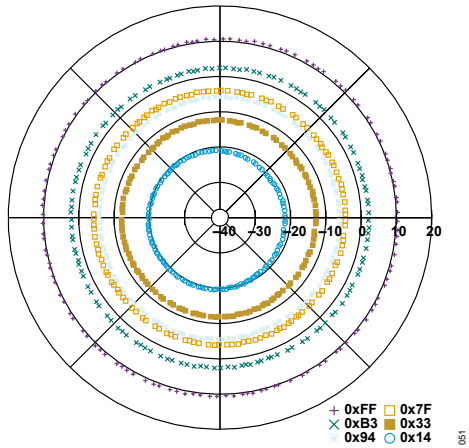

Figure 59. Gain Variation vs. Phase over Gain, 14 GHz, Transmit Channel

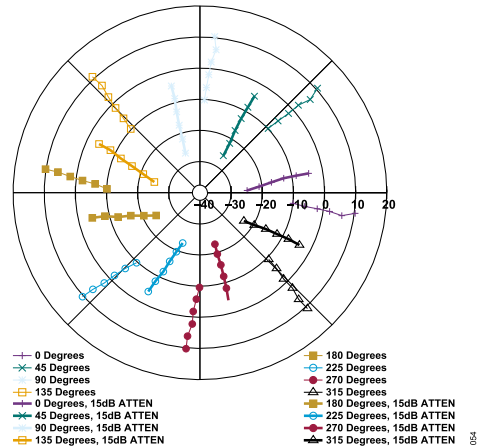

Figure 62. Phase Variation vs. Gain over Phase, 14 GHz, Transmit Channel

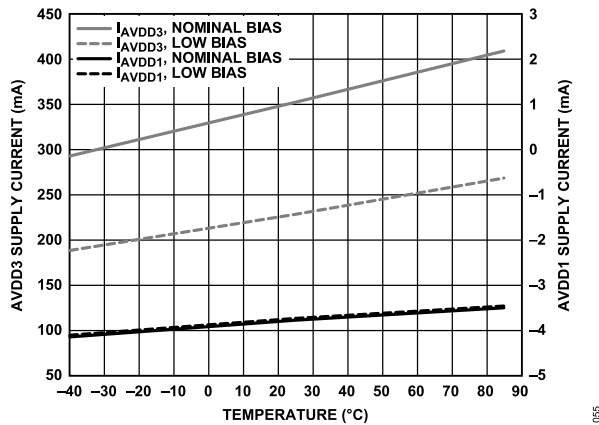

Figure 60. AVDD3 and AVDD1 Supply Current vs. Temperature, Four Transmit Channels Enabled, Normal Bias Mode and Low Bias Mode

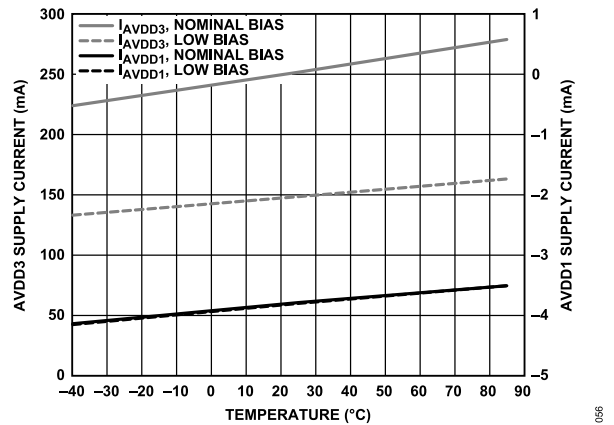

Figure 63. AVDD3 and AVDD1 Supply Current vs. Temperature, Four Receive Channels Enabled, Normal Bias Mode and Low Bias Mode

TYPICAL PERFORMANCE CHARACTERISTICS

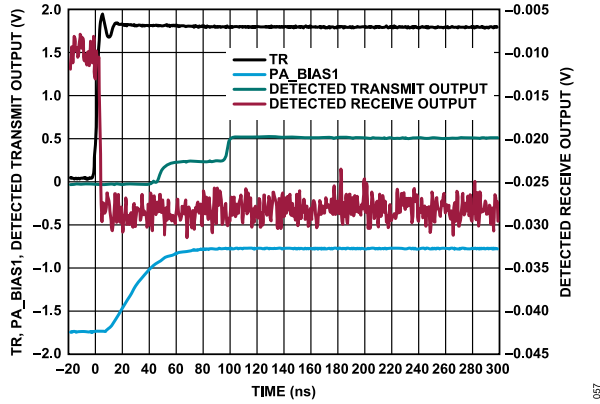

Figure 64. Receive to Transmit Switching Response to TR Rising Edge

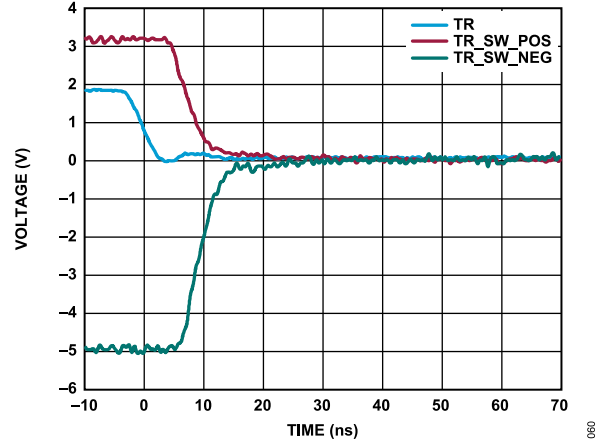

Figure 67. TR_SW_POS and TR_SW_NEG Response to TR Falling Edge

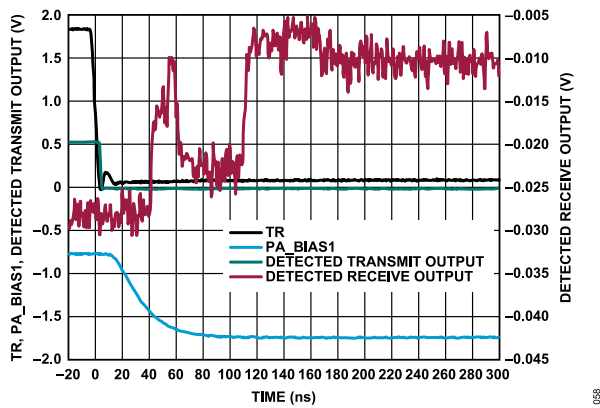

Figure 65. Transmit to Receive Switching Response to TR Falling Edge

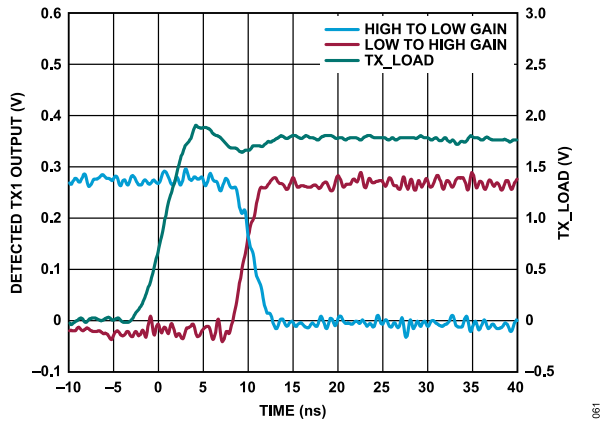

Figure 68. Gain Settling Response to TX_LOAD

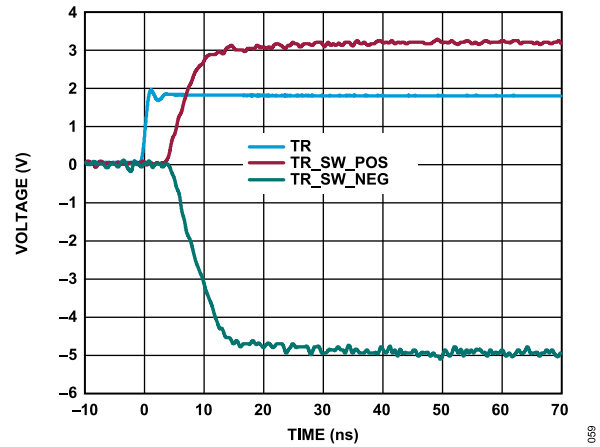

Figure 66. TR_SW_POS and TR_SW_NEG Response to TR Rising Edge

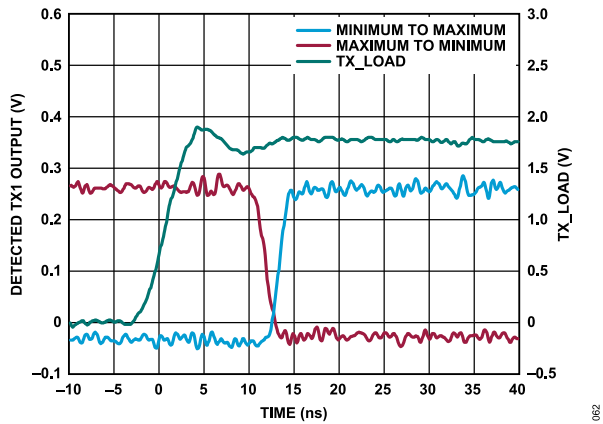

Figure 69. Phase Settling Response (as TX1 Vector Modulator Inphase-Channel Output) to TX_LOAD

TYPICAL PERFORMANCE CHARACTERISTICS

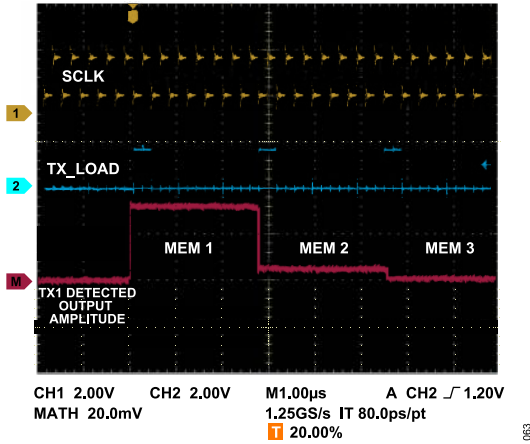

Figure 70. Beam Position Memory Advance vs. TX_LOAD

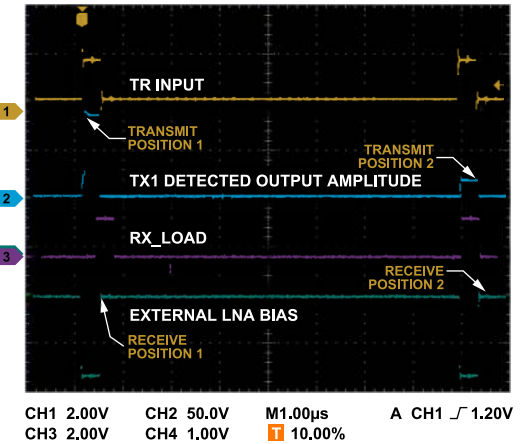

Figure 71. Beam Position Memory Advance vs. RX_LOAD with Transmit and Receive Switching

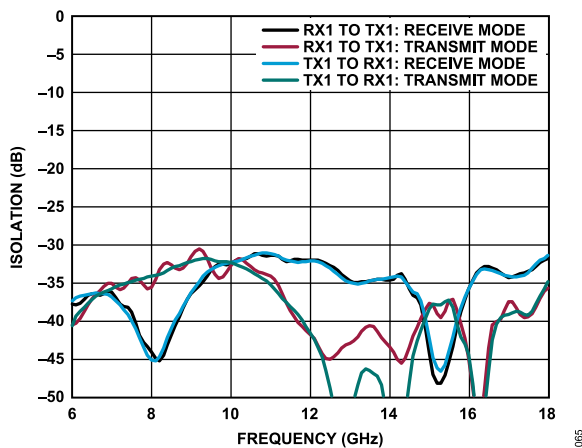

Figure 72. Isolation vs. Frequency, Transmit to Receive Channel

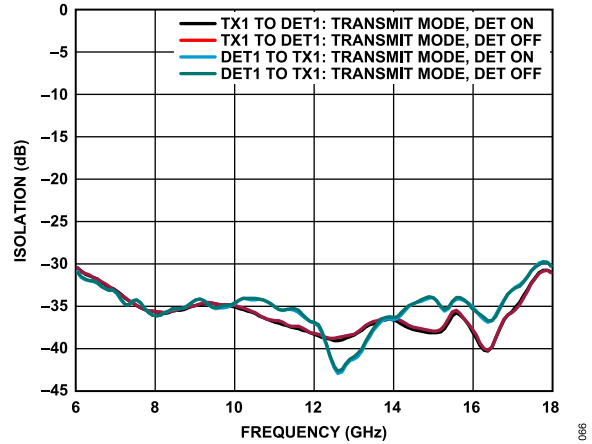

Figure 73. Isolation vs. Frequency, Transmit to Detector and Detector to Transmit

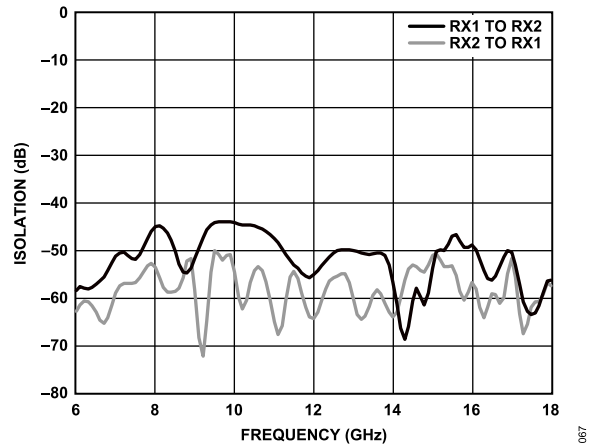

Figure 74. Isolation vs. Frequency, Receive Channel to Receive Channel

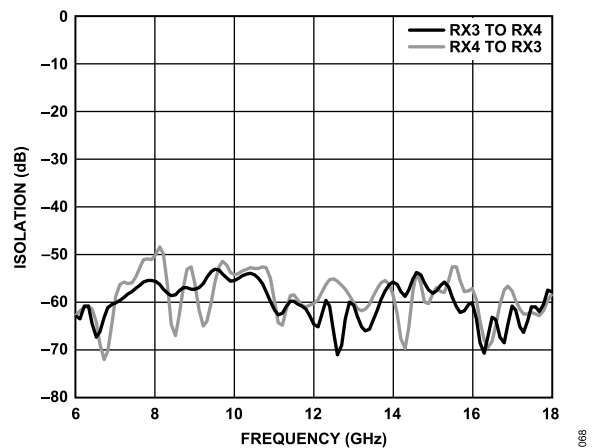

Figure 75. Isolation vs. Frequency, Receive Channel to Receive Channel

TYPICAL PERFORMANCE CHARACTERISTICS

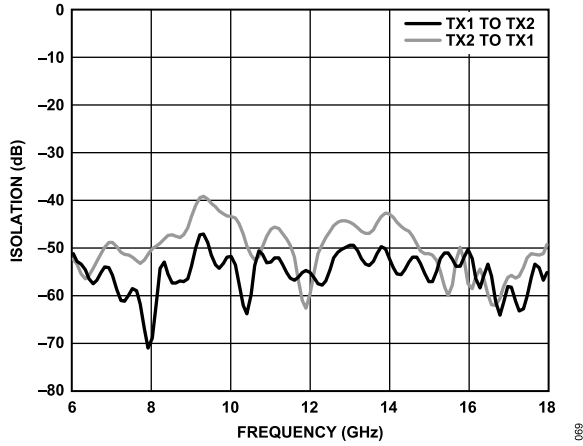

Figure 76. Isolation vs. Frequency, Transmit Channel to Transmit Channel

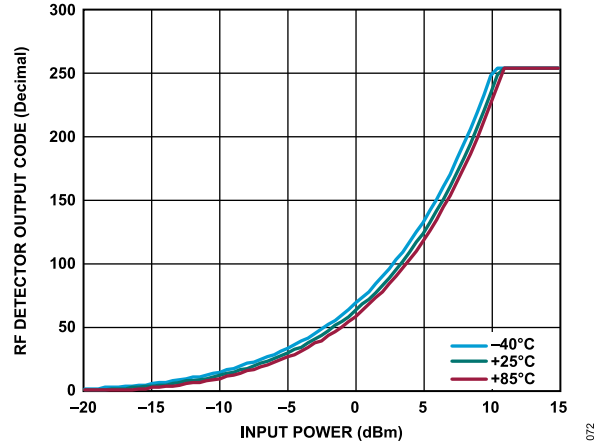

Figure 79. RF Detector Output Code vs. Input Power and Temperature, 11.5 GHz

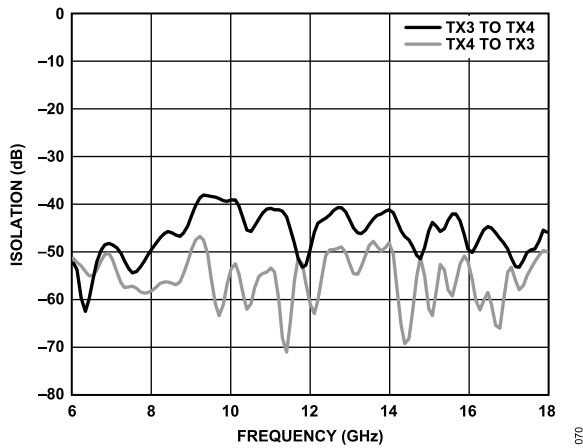

Figure 77. Isolation vs. Frequency, Transmit Channel to Transmit Channel

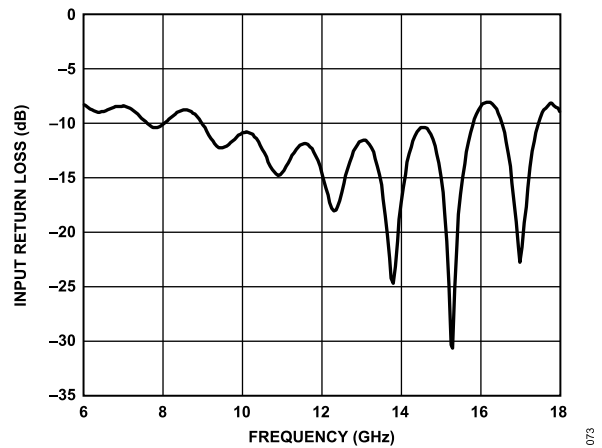

Figure 80. Input Return Loss vs. Frequency, RF Detector

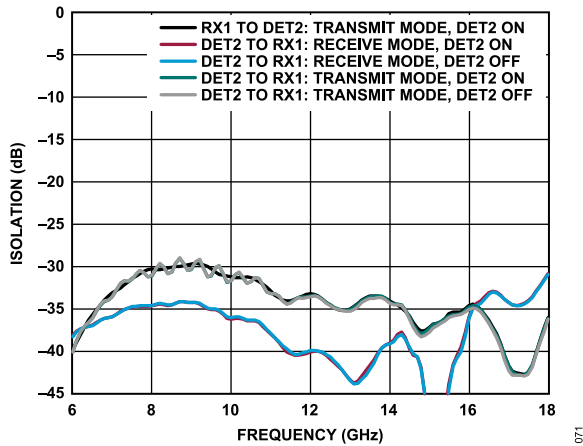

Figure 78. Input Isolation vs. Frequency, Receive to Detector and Detector to Receive

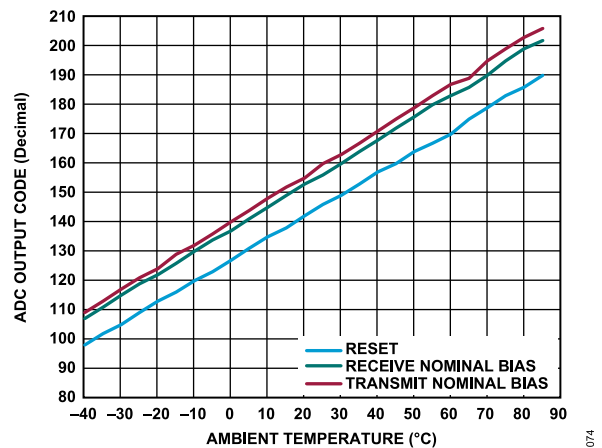

Figure 81. ADC Output Code vs. Ambient Temperature, Temperature Sensor

EQUIVALENT CIRCUITS

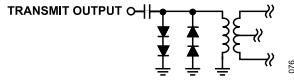

Figure 82. Transmit Output Equivalent Circuit

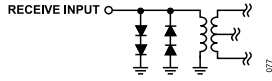

Figure 83. Receive Input Equivalent Circuit

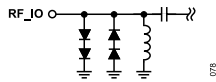

Figure 84. Common RF_IO Interface Schematic

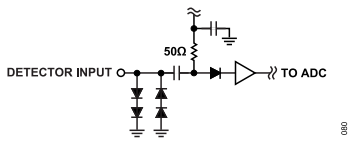

Figure 85. Simplified Power Detector Schematic

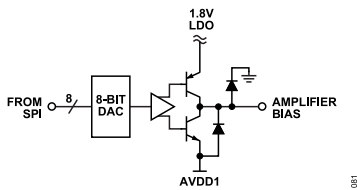

Figure 86. Simplified PA/LNA Bias DAC Schematic

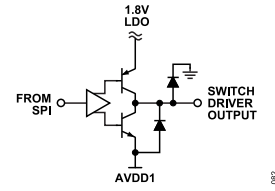

Figure 87. TR_SW_NEG and TR_POL Switch Driver

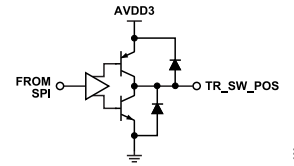

Figure 88. TR_SW_POS Switch Driver

THEORY OF OPERATION

RF PATH

The ADAR1000 contains four identical transmit and receive channels for time division duplex (TDD) operation. As shown in Figure 89, each receive channel includes an LNA followed by a vector modulator based phase shifter and a VGA. Each transmit channel includes a VGA followed by a vector modulator based phase shifter and a driver amplifier. These six blocks, per receive and transmit channel, constitute the RF subcircuits. A control switch selects between the transmit and receive paths. A step attenuator stage of 0 dB or 15 dB is located in the common path and shared between the transmit and receive modes before connecting to the passive 4:1 combining network (while in receive mode) or splitting network (while in transmit mode). The primary function of the chip is to accurately set the relative phase and gain of each channel so that the signals coherently add in the desired spatial direction. The individual path gain control can compensate for temperature and process effects and provides tapering for the beam to achieve low-side lobe levels.

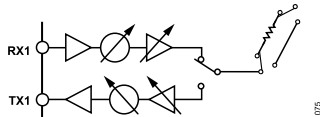

Figure 89. Transmit and Receive Channel Functional Diagram

As shown in Figure 82 and Figure 83, the transmit output and receive input of each channel is connected to a balun, which converts the single-ended signal to the differential signal required for the active RF circuit blocks. The balun networks also match the input and outputs to 50 Ω over the operating bandwidth. Figure 84 shows the interface schematic for the common RF_IO port, which is single-ended, matched to 50 Ω over the operating bandwidth, and connected to dc ground through a shunt matching inductor.

DIGITAL INTERFACE

The digital interface is composed of several pins. A high level block diagram is shown in Figure 90. The pins that are most often used are the SPI pins: CSB, SCLK, SDIO, and SDO. These pins are used when setting and reading the values in the control registers and the data in memory. The TR pin controls the device state: transmit or receive operation. The TX_LOAD pin and the RX_LOAD pin update the gain and phase while operating in RAM bypass mode (data is sourced from registers), or advance the beam position while sourcing data from the RAM (along with six or more clock cycles). The ADDR0 pin and the ADDR1 pin provide the user with a method to address an individual ADAR1000 chip on an SPI bus shared by up to four chips. The following sections discuss information related to these pins.

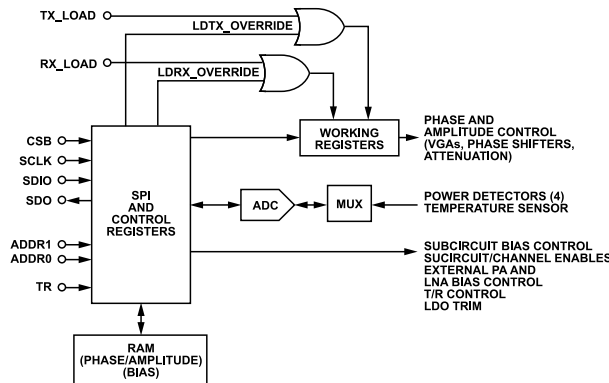

Figure 90. Digital Interface Block Diagram

THEORY OF OPERATION

PHASE AND GAIN CONTROL

Phase control is implemented using the active vector modulator architecture shown in [Figure 91](#). The incoming signal is split into equal amplitude, inphase and quadrature (I and Q) signals that are amplified independently by two identical VGAs and summed at the output to generate the required phase shift. Note that the I VGA and Q VGA are different than the VGA shown in [Figure 89](#). Six bits control each VGA inside the vector modulator, five bits for amplitude control and one bit for polarity control, for a total of 12 bits per phase shifter. The vector modulator output voltage amplitude (V_{OUT}) and phase shift (Φ) are given by the following equations:

$$V_{OUT} = \sqrt{V_I^2 + V_Q^2} \tag{1}$$

$$\Phi = \arctan(V_Q/V_I)$$

where:

V_I is output voltage of the I channel VGA.

V_Q is the output voltage of the Q channel VGA.

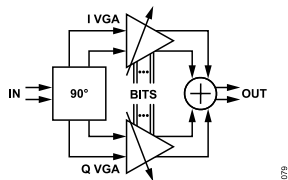

Figure 91. Active Vector Modulator Phase Shifter Block Diagram

Note that when evaluating the arctangent function, the proper phase quadrant must be selected. The signs of V_Q and V_I determine the phase quadrant according to the following:

- ▶ If V_Q and V_I are both positive, the phase shift is between 0° and 90° .
- ▶ If V_Q is positive and V_I is negative, the phase shift is between 90° and 180° .
- ▶ If V_Q and V_I are both negative, the phase shift is between 180° and 270° .
- ▶ If V_Q is negative and V_I is positive, the phase shift is between 270° and 360° .

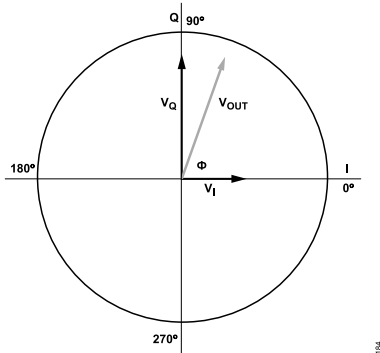

Figure 92. Vector Gain Representation

In general, select the V_Q and V_I values to give the desired phase shift while minimizing the variation in V_{OUT} , which minimizes the variation in gain. However, allowing some amplitude variation can result in finer phase step resolution and/or lower phase errors.

[Table 10](#), [Table 11](#), [Table 12](#), and [Table 13](#) in the [Phase Control Registers](#) section details the values to set in Register 0x014 to Register 0x01B for the receive channels and Register 0x020 to Register 0x027 for the transmit channels, to sweep the phase while keeping the gain of the vector modulator constant. Keeping the vector modulator gain constant degrades the phase resolution to 2.8° . [Table 10](#) to [Table 13](#) can be used when writing the phase data into RAM. The ADAR1000 RAM [memory map](#) can be found on the ADAR1000 product page.

If the values given in [Table 10](#), [Table 11](#), [Table 12](#), and [Table 13](#) are used, the VGA exclusively executes the gain control in either the transmitter or receiver path. Register 0x010 to Register 0x013 and Register 0x01C to Register 0x01F control the receive and transmit VGAs, respectively. If using values not found in [Table 10](#), [Table 11](#), [Table 12](#), and [Table 13](#), be aware that both the vector modulator and the VGA affect the total gain.

The total gain (in dB) ($GAIN_{TOTAL}$) is calculated by the following equation:

$$GAIN_{TOTAL} \text{ (dB)} = GAIN_{VM} \text{ (dB)} + GAIN_{VGA} \text{ (dB)} + GAIN_{AMP} \text{ (dB)} + GAIN_{ATT} \text{ (dB)}$$

where:

$GAIN_{VM}$ is the vector modulator gain.

$GAIN_{VGA}$ is the VGA gain from any of the transmit and receiver paths.

$GAIN_{AMP}$ is either the (on-chip) LNA of the receive paths or the driver amplifier of the transmit paths.

$GAIN_{ATT}$ is the gain of the switched attenuator in the common-path, either 0 dB or -15 dB.

RECEIVE OUTPUT NOISE AND NOISE FIGURE

Noise figure for the receive signal chain is measured with only a single path enabled. Enabling all four receive paths increases the output noise by approximately 6 dB. However, the coherent gain increases by 12 dB relative to a single path. Therefore, the signal-to-noise ratio increases by 6 dB (relative to the signal-to-noise ratio of the single receive path, with only one path enabled).

TRANSMIT AND RECEIVE CONTROL

Properly transitioning from transmit mode to receive mode, and vice versa, is key to operating a TDD or radar phased array system. The ADAR1000 performs the transmitter to receiver and receiver to transmitter functionality based on a transmit or receive control signal input to the chip. Mode transition can be accomplished through either a SPI register write or via the state of the TR pin.

When using the SPI, Register 0x31 controls all that is required to change the transmit and receive state:

THEORY OF OPERATION

- ▶ Bit 1: TR_SPI. When in SPI control, determines receive (low) or transmit (high) mode.
- ▶ Bit 2: TR_SOURCE. Determines whether the SPI (low) or the TR pin (high) is used for transmit and receive control.
- ▶ Bit 5: RX_EN. Must also be asserted high to turn on the receive subcircuits. The LNA_BIAS pin voltage follows this bit. Used in SPI control.
- ▶ Bit 6: TX_EN. Must also be asserted high to turn on the transmit subcircuits. The PA_BIASx pins follows this bit. Used in SPI control.

Note that the BIAS_CTRL bit (Bit 6, Register 0x030) must be high for RX_EN and TX_EN to control the bias pins. Register 0x031 also controls the external switch drivers (see the [External Switch Control](#) section).

When the TR_SOURCE bit (Bit 2, Register 0x031) is high, the TR pin controls all operation necessary to switch from receive to transmit and vice versa. This operation includes setting the on-chip and off-chip transmit and receive switches, enabling/disabling the receive or transmit subcircuits, as well as turning on and off the gate bias for the external PAs and LNAs if the BIAS_CTRL bit (Bit 6, Register 0x030) is high.

RF SUBCIRCUIT BIAS CONTROL

Use Register 0x034 through Register 0x037 to adjust the bias current setting of each of the active RF subcircuits to trade RF performance for lower dc power.

[Table 6](#) provides the recommended settings for the nominal and low operating power modes. The nominal power mode provides

Table 6. SPI Settings for Nominal and Low Power Modes

Subcircuit	Register	Bit Field	Power Mode	
			Nominal Setting	Low Setting
Receive LNA	0x034	LNA_BIAS	8	5
Receive Vector Modulator	0x035	RX_VM_BIAS	5	2
Receive VGA	0x035	RX_VGA_BIAS	10	3
Transmit Vector Modulator	0x036	TX_VM_BIAS	5	2
Transmit VGA	0x036	TX_VGA_BIAS	5	5
Transmit Driver	0x037	TX_DRV_BIAS	6	3

optimized RF performance relative to power consumption. When reducing dc power for power sensitive applications, this power reduction is at the expense of lower gain, higher noise figure, and lower linearity.

RF SUBCIRCUIT ENABLES AND DISABLES

When using the SPI for transmit and receive control, RF subcircuits and/or channels can be individually enabled via Register 0x02E (receive channel enables) and Register 0x02F (transmit channel enables). The TX_EN and RX_EN bits (Bits[6:5], Register 0x031) must also be at logic high to enable the transmit or receive subcircuits, respectively. The transmit and receive subcircuits cannot be turned on simultaneously, and if both TX_EN and RX_EN are high, both the transmit and receive subcircuits power down.

If using the TR pin for transmit and receive control, the functions of the TX_EN and RX_EN automatically follow the state of the TR pin input, allowing fast switching between transmit and receive modes. The fast switching is achieved with the TR pin ultimately controlling enable override signals that are internal to the ADAR1000 (RX_EN_OVERRIDE and TX_EN_OVERRIDE). These signals turn all the receive subcircuits off and transmit subcircuits on while in transmit mode, and all the transmit subcircuits off and all the receive subcircuits on while in receive mode.

The overall receive and transmit subcircuit enable/disable logic is shown in [Figure 93](#) for the receive subcircuits and [Figure 94](#) for the transmit subcircuits.

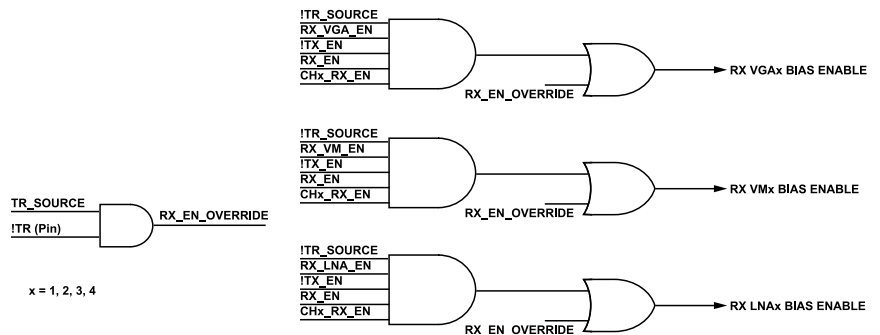

Figure 93. Receive Subcircuit Enabling Logic

THEORY OF OPERATION

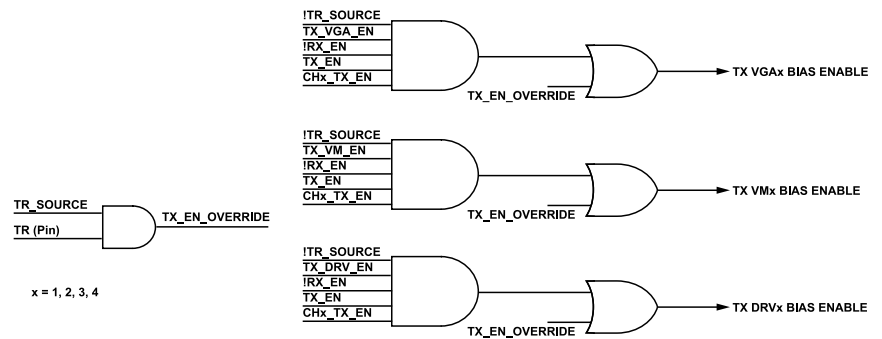

Figure 94. Transmit Subcircuit Enabling Logic

POWER DETECTORS

Four power detectors are provided to sample peak power coupled from the outputs of off-chip power amplifiers for power monitoring. The on-chip ADC selects from the four detectors and converts the analog voltage output of the detector to an 8-bit digital word that is read from Register 0x33. Figure 85 shows a simplified power detector schematic. Each detector input is ac-coupled to a diode-based detector, and then amplified and routed to the ADC. A reference diode (not shown in Figure 85) provides temperature compensation to minimize variation in the output voltage vs. the input power response over the operating temperature range.

The detector inputs are matched on chip to 50 Ω . Register 0x030 contains an enable bit (CHx_DET_EN) for each detector so that the detectors can be powered down when not in use. For unused detectors, a 50 Ω termination or analog ground connection is recommended on the detector RF inputs, but they can also be left floating.

EXTERNAL AMPLIFIER BIAS DRIVERS

Five bias driver outputs are provided for biasing off chip gallium arsenide (GaAs) or gallium nitride (GaN) amplifiers:

- ▶ PA_BIAS1, PA_BIAS2, PA_BIAS3, and PA_BIAS4
- ▶ LNA_BIAS

Each driver is controlled with an 8-bit DAC. One driver is intended for each off chip PA (four in total), and the fifth driver is shared between multiple off chip LNAs (usually four in total). Figure 86 shows a simplified schematic for the bias driver and DAC. An 8-bit word from the SPI sets the DAC output, which is amplified and translated to a 0 V to -4.8 V range intended for the gate bias of the GaAs or GaN PAs. A push pull output stage allows sourcing or sinking of up to 10 mA for PAs that can draw significant gate current when pushed deep into compression. The LNA bias DAC also includes a disable mode with a high output impedance, which provides flexibility for self biased LNAs that also have an external gate voltage adjustment capability. The LNA_BIAS_OUT_EN bit (Bit 4, Register 0x030) provides this control.

Two SPI registers are associated with each bias driver output, an on bias register (Register 0x029 through Register 0x02D) for setting

the bias voltage for when the amplifier is active, and an off bias register (Register 0x046 through Register 0x04A) for setting the appropriate bias voltage for turning the amplifier off. The BIAS_CTRL bit (Bit 6, Register 0x030) determines whether the driver bias outputs must be changed by loading the new settings over the SPI each time, and whether the outputs switch between the on and off registers with the TX_EN or RX_EN signal (SPI transmit and receive mode) or with the state of the TR pin. A 0x00 value in the on or off bias registers, correspond to a 0 V output. A 0xFF in the on or off bias registers correspond to a -4.8 V output.

EXTERNAL SWITCH CONTROL

The chip provides three driver outputs for external GaAs switch control as follows:

- ▶ TR_SW_NEG for an external negative voltage control transmit or receive switch. Outputs between 0 V and AVDD1 (nominally -5 V). A push pull output stage allows sourcing or sinking of up to 1 mA (See Figure 87).
- ▶ TR_SW_POS for a positive voltage control transmit/receive switch. Outputs between 0 V and AVDD3 (nominally 3.3 V) (See Figure 88).
- ▶ TR_POL for a negative voltage control polarization switch. Outputs between 0 V and AVDD1 (nominally -5 V). A push pull output stage allows sourcing or sinking of up to 1 mA (Figure 87).

The external transmit or receive switch driver outputs change state along with the on-chip transmit or receive switches via the transmit or receive control signal (either through the SPI or the TR pin). Register 0x031 (SW_CTRL) contains all the control bits required for both switch drivers. The polarity of the transmit and receive switch driver output with respect to the transmit and receive control signal is set via the SW_DRV_TR_STATE bit (Bit 7, Register 0x031) to provide flexibility for different GaAs switches. See Table 14 complete control information for TR_SW_POS and TR_SW_NEG.

The external polarization switch changes with the state of the POL bit (Bit 0, Register 0x031). With POL = 0, TR_POL outputs 0V, whereas POL = 1 outputs -5 V. Assert the SW_DRV_EN_TR and SW_DRV_EN_POL bits high (Bits[4:3], Register 0x031) to enable the switch drivers.

THEORY OF OPERATION

ADC OPERATION

The chip contains an 8-bit ADC for sampling the outputs of the four power detectors and the temperature sensor. Register 0x032 controls the ADC. The 8-bit output is read (only) from Register 0x033 (ADC_OUTPUT). The control bits in Register 0x32 are as follows:

- ▶ The ADC_EOC (Bit 0) read bit indicates when a conversion is complete and the 8-bit output is available for reading over the SPI. This is low during a conversion cycle and a high indicates a conversion is complete.
- ▶ A multiplexer (mux) selects between the five inputs based on MUX_SEL (Bits[3:1]). See [Table 7](#).
- ▶ The ST_CONV bit (Bit 4) initiates a conversion, which requires 16 clock cycles for a minimum conversion time of 8 μ s (2 MHz clock). This bit is active high and is self clearing.
- ▶ The CLK_EN (Bit 5) turns on ADC clock oscillator; active high.
- ▶ The ADC_EN (Bit 6) turns on and resets ADC; active high
- ▶ The ADC_CLKFREQ_SEL (Bit 7) selects between a 2 MHz and a 250 kHz clock frequency (low and high, respectively).

The following details the ADC conversion cycle sequence:

1. The ST_CONV bit is asserted high via SPI write to Register 0x32.
2. The ADC input is sampled during four ADC clock cycles.
3. The ADC input is held and the conversion happens over the next 12 ADC clock cycles.
4. The ADC_EOC bit asserts high and data in Register 0x33 becomes valid after 16 total ADC clock cycles.

Table 7. Mux Selection Decoding

MUX_SEL (Bits[3:1])	Selection
0b000	Temperature sensor
0b001	Detector 1
0b010	Detector 2
0b011	Detector 3
0b100	Detector 4

CHIP ADDRESSING

Use the ADDR1 and ADDR0 pins to set the address of each individual chip. The user can connect the SCLK, CSB, SDIO, and SDO lines of up to four chips together and individually write to and read from each chip. The ADDR1 and ADDR0 values correspond to the AD1 and AD0 bits (Bits[14:13] of the SPI address header) shown in [Figure 2](#).

An example write to Chip 2 has the following address bit settings. For a group of four chips, indexed 0 to 3, ADDR1 is set to high and ADDR0 is set to low with the address header Bits[14:13] = 10.

The user also has the option to write to all four chips with a single write by setting the address header Bits[14:11] = 0001. Note that this type of broadcast SPI write is only applicable to the register space of the chips on the SPI bus. It is not applicable to the RAM

space on the chip. The user must write to the RAM of each chip on the SPI individually.

MEMORY ACCESS

On-chip RAM is provided for storing phase and amplitude settings for up to 121 beam positions and seven bias settings for both transmit and receive modes, as shown in the ADAR1000 [Memory Map](#) document, found on the product webpage. A beam position consists of the gain, Vector Modulator I, and Vector Modulator Q settings for all four channels. The ADAR1000 [memory map](#) shows where in the RAM the receive beam position data, transmit beam position data, receive bias setting data, and transmit bias setting data are located.

The BEAM_RAM_BYPASS bit in Register 0x038 determines where the amplitude and phase settings are sourced from.

- ▶ If BEAM_RAM_BYPASS = 0, data sourced from memory.
- ▶ If BEAM_RAM_BYPASS = 1, data sourced from registers.

Receive beam positions start at Address 0x1000 and transmit beam position start at 0x1800. Receive bias settings start at Address 0x1790 and transmit bias settings start at 0x1F90.

On soft reset of the ADAR1000, the data stored in the RAM is not affected. However, on a power cycle, the data in the RAM is undefined. The user must rewrite to the RAM after each power cycle for valid data.

All four amplitude and phase settings of the receive and transmit channels can be loaded from the same beam position index, or the amplitude and phase settings can be pulled from different beam position indices for each receive or transmit channel, allowing even greater flexibility. This is described in [Single Memory Fetch](#) section.

Sourcing bias data from memory is described in the [Bias Setting Memory Fetch](#) section.

The on-chip RAM also has a memory sequencer that can be enabled, which allows the user to sequence through any desired set of beam positions (see the [Sequencing Through Memory Beam Positions](#) section).

An example of writing gain, phase, and bias values to the memory is provided in [Table 31](#) in the [SPI Programming Example](#) section.

Single Memory Fetch

After the beam position data is written to the RAM (see the ADAR1000 [Memory Map](#)), perform the following steps to fetch a beam position from memory:

1. Set BEAM_RAM_BYPASS low in Register 0x038.
2. Perform Step a or Step b, but not both:
 - a. For loading all four transmit/receive channels with the same beam position index, write the desired 7-bit beam position (0 through 120) to Register 0x039 (for receive) or Register

THEORY OF OPERATION

0x03A (for transmit) and assert the fetch bit high (Bit 7) in each register.

- b. For loading different beam positions indices to individual channels, assert TX_CHX_RAM_BYPASS in Register 0x38 for transmit channels and/or RX_CHX_RAM_BYPASS for receive channels. Then, write the desired 7-bit beam position to Register 0x3D through Register 0x40 for the receive channels and Register 0x41 through Register 0x44 for the transmit channels, and assert the fetch bit high in each register.
3. Provide at least six additional clock cycles on SCLK to load the new data from the RAM. For data load, SCLK is independent of CSB state. Data is loaded when CSB is high and SCLK is applied or when CSB is low during a SPI write/read.
4. Pulse the TX_LOAD/RX_LOAD pin or the LDTX_OVERRIDE/LDRX_OVERRIDE bit for the new data to take effect. Keep the transmit and receive load commands separate because loading problems can occur when the TX_LOAD and RX_LOAD pins are pulsed high together or the LDTX_OVERRIDE/LDRX_OVERRIDE bits are asserted high in the same SPI write. Keep the pin pulsing separated by at least eight SCLK cycles for the former, and asserting the bits in separate SPI writes for the latter.

Bias Setting Memory Fetch

Seven memory locations are provided for storing bias settings for all the transmit subcircuits (also stored in Register 0x036 and Register 0x037) and the external PA bias on and off values for the PA_BIASx pins (also stored in Register 0x29 through Register 0x2C and Register 0x46 through Register 0x49). Similarly, seven memory locations are provided for storing bias settings for the receive channel subcircuits (also stored in Register 0x34 and Register 0x35) and the external LNA bias on and off values for the LNA_BIAS pin (also stored in Register 0x2D and Register 0x4A) When the BIAS_RAM_BYPASS bit (Register 0x38, Bit 5) is at logic low, all subcircuit and external bias settings are sourced from memory (instead of the registers).

After the bias setting is written to the RAM (see the ADAR1000 [Memory Map](#)), perform the following steps to fetch a bias setting from memory:

1. Set BIAS_RAM_BYPASS low in Register 0x038.
2. Write the desired 3-bit bias setting (Value 0 through Value 6 maps to bias Setting 1 through Setting 7) to Register 0x051 (for receive) or Register 0x052 (for transmit), and assert the fetch bit high (Bit 3) in each register.
3. Provide at least six additional clock cycles on SCLK to load the new data from the RAM. For data load, SCLK is independent of the CSB state: data is loaded when CSB is high and SCLK is applied or when CSB is low during a SPI write/read.

Sequencing Through Memory Beam Positions

The beam positions can be stepped sequentially through the positions stored in memory. Sequencing through the beam positions eliminates the need for a SPI register write to load the next beam position, resulting in faster beam transitions. An example of this operation is shown in [Figure 70](#). To use this function, perform the following steps:

1. Load Register 0x04D and Register 0x04E with the desired 7-bit transmit channel start and stop beam position indices of the sequence
2. Load Register 0x04F and Register 0x050 with the desired 7-bit receive channel start and stop beam position indices of the sequence.
3. If sequencing through transmit beam positions, assert only TX_BEAM_STEP_EN, and keep RX_BEAM_STEP_EN low in Register 0x038. If RX_BEAM_STEP_EN is also asserted high, the first transmit beam position of the first sequence does not fetch and load correctly. However, on subsequent times through the sequence, the first transmit beam position loads correctly when RX_BEAM_STEP_EN is asserted high.

If sequencing through receiver beam positions, TX_BEAM_STEP_EN and RX_BEAM_STEP_EN bits can both be asserted high. The first receive beam position fetches and loads correctly when TX_BEAM_STEP_EN is asserted high.

4. Provide at least six additional clock cycles on SCLK to load the starting beam position from the RAM. For data load, SCLK is independent of the CSB state. Data is loaded when CSB is high and SCLK is applied or when CSB is low during a SPI write/read.
5. Pulse the TX_LOAD/RX_LOAD pin or the LDTX_OVERRIDE/LDRX_OVERRIDE bit for the starting beam position to take effect.

Keep the transmit and receive load commands separate because loading problems can occur when the TX_LOAD and RX_LOAD pins are pulsed high together or the LDTX_OVERRIDE/LDRX_OVERRIDE bits are asserted high in the same SPI Write. Keep the pin pulsing separated by at least 8 SCLK cycles for the former, and asserting the bits in separate SPI writes for the latter.

6. Repeat the last two steps for the next sequential beam position to take effect.

After the stop beam position is loaded, the sequence returns to the start beam position and repeats.

Toggling Between RAM and Registers

While stepping through the beam positions in the RAM, data can be sourced from the SPI registers, and then sourced from RAM again with the following procedure:

THEORY OF OPERATION

1. Assert the BEAM_RAM_BYPASS bit high to source the data from the SPI registers.
2. Perform a transmit or receive load command over the SPI or the pins to load the gain and phase data from the registers.
3. To source the data from the RAM again, deassert the BEAM_RAM_BYPASS bit, provide at least six additional clock cycles, and perform another transmit or receive load command.

When toggling from RAM to registers, and back to RAM, the memory position increments twice through this process because the TX_BEAM_STEP_EN and RX_BEAM_STEP_EN bits are held high through the process. The memory sequencer stays enabled.

In the first increment of the memory sequencer, six or more SCLK cycles are provided while asserting the BEAM_RAM_BYPASS bit with a SPI write. Then a transmit or receive load command is issued to load the register gain and phase data.

In the second increment of the memory sequencer, six or more SCLK cycles are provided while deasserting BEAM_RAM_BYPASS bit with a SPI write. Then a transmit or receive load command is issued to load the next memory position.

In other words, if the user is at Beam Position N before asserting BEAM_RAM_BYPASS, the beam position changes to N + 2 after this RAM to Register to RAM sequence is completed.

Note that if TX_BEAM_STEP_EN or RX_BEAM_STEP_EN is deasserted and then reasserted, the sequencer is reset, and begins again at its programmed start beam position index.

Memory Counter Attributes

The receive and transmit memory counters used to sequence through the beam positions feature the following attributes:

- ▶ The receiver and transmitter are not independent of each other and need to be controlled separately for proper operation.
- ▶ The TX_LOAD and RX_LOAD pins cannot be tied together to advance the transmit and receive memory counters together because doing so causes the beam positions to load improperly. Keep the pulsing of these load pins separated by a minimum of 8 SCLK cycles for proper beam position loading from memory.
- ▶ The transmit beam position can be advanced while the device is in receive mode, and vice versa.
- ▶ Multiple beam position advances can be performed on the transmit while the device is in receive mode, and vice versa.

CALIBRATION

There is no built in calibration or factory calibration for the magnitude and phase of each gain and phase of the RF channel. The rms phase error resulting from using the I and Q settings is determined from the equations previously provided in the [Phase and Gain Control](#) section. The rms phase error can be improved by running a full over the air active electronically scanned array (AESA) calibration of each channel at the desired frequency operation.

MEMORY ADDRESS DECODING

The beam positions in RAM have several reserved (unused) and nonfunctional addresses. These addresses occur between consecutive beam positions, bias settings, and between receive data and transmit data. Reserved addresses were added to easily address particular data in memory. Address Bit[12] controls whether access to register addresses (low) or RAM addresses (high). Use the decoding structure shown in [Table 8](#) for the remaining address Bits[11:0] if Bit 12 = 1.

Table 8. Address Decoding Structure

Address Bit	Description
11	0 = receive address space 1 = transmit address space
[10:4]	Beam position index; the bias setting index is transmit and receive dependent (see the Memory Map section) 0b0000000 = beam Position 0 0b1111000 = beam Position 120
[3:2]	0b00 = Channel 1 0b01 = Channel 2 0b10 = Channel 3 0b11 = Channel 4
[1:0]	Gain and phase data; the bias setting data is transmit and receive dependent (see the Memory Map section) 0b00 = VGA gain 0b01: Vector Modulator I vector 0b10: Vector Modulator Q vector

As an example, to access receive Channel 2, for Beam Position 65, the bits are as follows:

- ▶ Address Bit 12 = 1
- ▶ Address Bit 11 = 0
- ▶ Address Bits[10:4] = 0b1000001 (65 or 0x41)
- ▶ Address Bits[3:2] = 0b01

Address Bits[1:0] are used to access the VGA Gain, I Vector, and Q vector data of receive Channel 2 for Beam Position 65.

MEMORY MAP

A [memory map](#) for the ADAR1000 RAM is provided on the product webpage. Note that the addresses in the memory map assume Chip 0 addressing (AD0 = 0, AD1 = 0). Bits[14:13] in the address value must change accordingly when addressing Chip 1, Chip 2, or Chip 3.

All memory locations that are reserved are non functional don't cares.

APPLICATIONS INFORMATION

GAIN CONTROL REGISTERS

The recommended gain control for each channel is provided through a combination of independent receive and transmit path VGAs. Each VGA provides over 16 dB of gain control range. A switched 0 dB or 15 dB step attenuator that is shared between the transmit and receive channels extends the total gain control range to greater than 31 dB. Gain control using the vector modulator is generally not recommended because gain variation vs. phase can increase if not using the values listed in Table 10, Table 11, Table 12, and Table 13. The VGA and attenuator gain of each receive or transmit channel is controlled by an 8-bit register. The VGAs require seven bits of control to ensure a 0.5 dB minimum step size with less than 0.25 dB error over all conditions, and the eighth bit controls the state of the switched attenuator.

The gain control registers for the receive channels are Register 0x010 through Register 0x013, and the gain control registers for the transmit channels are Register 0x01C through Register 0x01F. Bits[6:0] (RX_VGA_CHx and TX_VGA_CHx) of each register control the VGA gain approximately as shown in Figure 95. Limit the usage to the top 16 dB of the gain control range for optimal gain linearity and repeatability. Bit 7 (CHx_ATT_N_RX and CHx_ATT_N_TX) of each register controls the attenuator state (logic high means that attenuator is bypassed).

The gain and phase registers are dual-rank registers, which allows the chip to actively receive or transmit using one amplitude and phase setting while loading the next setting in the background.

To source and update the amplitude and phase settings from the registers, follow these steps:

1. Assert the BEAM_RAM_BYPASS bit (Bit 6 of Register 0x038) high to source the gain and phase data from the registers.
2. Write data to Register 0x010 through Register 0x01B to set the receive channel gains and phases.
3. Write data to Register 0x01C through Register 0x027 to set the transmit channel gains and phases.
4. Issue a transmit or receive load command.

The gain and phase settings in Step 2 and Step 3 are initially written to holding registers and do not take effect until the transmit and/or receive load command is issued. This action transfers the new settings from the holding registers to the working registers, causing the new settings to take effect in the RF subcircuits.

There are two ways issue a transmit load command.

- ▶ Assert the LDTX_OVERRIDE bit in Register 0x28 high
- ▶ Send a positive pulse to the TX_LOAD pin

There are two ways issue a receive load command.

- ▶ Assert the LDRX_OVERRIDE bit in Register 0x28 high
- ▶ Send a positive pulse to the RX_LOAD pin

Note that the LDTX_OVERRIDE signal is OR'ed with the TX_LOAD signal on chip, and the LDRX_OVERRIDE signal is OR'ed with the RX_LOAD signal on chip. If not using the TX_LOAD and RX_LOAD pins, pull these pins logic low.

As an alternative to the registers, up to 121 gain and amplitude settings for both the receive and the transmit modes can be stored in the on-chip memory. To load new settings from the on-chip memory, see the Memory Access section.

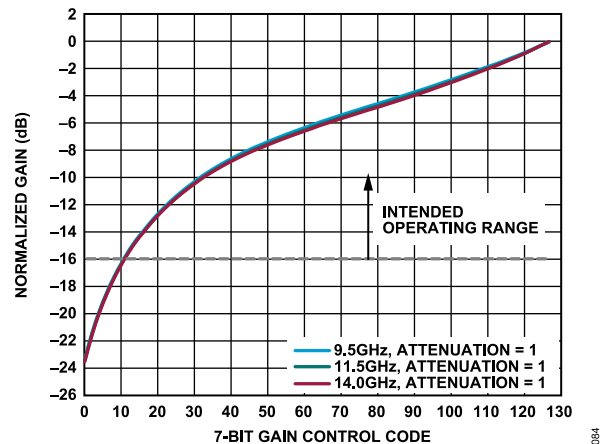

Figure 95. Normalized Gain vs. 7-Bit Gain Control Code

SWITCHED ATTENUATOR CONTROL

The state of the switched attenuator also depends upon the transmit and receive control signal because the attenuator is shared between the transmit and the receive paths. The CHx_ATT_N_RX bit (Bit 7) of Register 0x010 through Register 0x013 control the state of the step attenuators while in receive mode. The CHx_ATT_N_TX bit (Bit 7) of Register 0x01C to Register 0x01F control the state of the step attenuators while in transmit mode. A pair of 2:1 switches on either side of each attenuator, which are controlled together, determines whether the attenuator for each channel is set according to the receive or transmit working registers as shown in Table 9.

Table 9. Step Attenuator Control

Channel Transmit and Receive State	CHx_ATT_N_RX ¹	CHx_ATT_N_TX ¹	Channel x Attenuator State ¹	Attenuation (dB)
Receive	1	X ²	Bypass	0
Receive	0	X ²	Attenuation	15
Transmit	X ²	1	Bypass	0
Transmit	X ²	0	Attenuation	15

¹ From SPI, x = 1, 2, 3, or 4.

APPLICATIONS INFORMATION

Table 9. Step Attenuator Control

Channel Transmit and Receive State	CHx_ATT_N_RX ¹	CHx_ATT_N_TX ¹	Channel x Attenuator State ¹	Attenuation (dB)
------------------------------------	---------------------------	---------------------------	---	------------------

² X means don't care.

PHASE CONTROL REGISTERS

Phase is determined by setting the I and Q VGA gains of the vector modulators. The phase control registers for the receive channels are Register 0x14 through Register 0x1B. The phase control registers for the transmit channels are Register 0x020 through Register 0x027.

Each register controls the gain of I or Q VGA and the polarity bit to determine the quadrant of the resultant vector. See [Figure 92](#) in the [Phase and Gain Control](#) section. [Table 10](#) maps the user desired phase to data of phase control registers. I Reg represents Register Bits[5:0], which includes the I polarity Bit 5 and the VM I Gain Bits[4:0]. Q Reg represents Bits[5:0], which includes the Q polarity Bit 5 and the VM Q Gain Bits[4:0].

Table 10. Quadrant 1 Phase Control—Mapping of I and Q VM VGA Register Settings to Phase Setting

Phase (Degrees)	I Reg (Hex)	Q Reg (Hex)
0	3F	20
2.8125	3F	21
5.625	3F	23
8.4375	3F	24
11.25	3F	26
14.0625	3E	27
16.875	3E	28
19.6875	3D	2A
22.5	3D	2B
25.3125	3C	2D
28.125	3C	2E
30.9375	3B	2F
33.75	3A	30
36.5625	39	31
39.375	38	33
42.1875	37	34
45	36	35
47.8125	35	36
50.625	34	37
53.4375	33	38
56.25	32	38
59.0625	30	39
61.875	2F	3A
64.6875	2E	3A
67.5	2C	3B
70.3125	2B	3C
73.125	2A	3C
75.9375	28	3C
78.75	27	3D
81.5625	25	3D

Table 10. Quadrant 1 Phase Control—Mapping of I and Q VM VGA Register Settings to Phase Setting

Phase (Degrees)	I Reg (Hex)	Q Reg (Hex)
84.375	24	3D
87.1875	22	3D

Table 11. Quadrant 2 Phase Control—Mapping of I and Q VM VGA Register Settings to Phase Setting

Phase (Degrees)	I Reg (Hex)	Q Reg (Hex)
90	21	3D
92.8125	01	3D
95.625	03	3D
98.4375	04	3D
101.25	06	3D
104.0625	07	3C
106.875	08	3C
109.6875	0A	3C
112.5	0B	3B
115.3125	0D	3A
118.125	0E	3A
120.9375	0F	39
123.75	11	38
126.5625	12	38
129.375	13	37
132.1875	14	36
135	16	35
137.8125	17	34
140.625	18	33
143.4375	19	31
146.25	19	30
149.0625	1A	2F
151.875	1B	2E
154.6875	1C	2D
157.5	1C	2B
160.3125	1D	2A
163.125	1E	28
165.9375	1E	27
168.75	1E	26
171.5625	1F	24
174.375	1F	23
177.1875	1F	21

Table 12. Quadrant 3 Phase Control—Mapping of I and Q VM VGA Register Settings to Phase Setting

Phase (Degrees)	I Reg (Hex)	Q Reg (Hex)
180	1F	20
182.8125	1F	01
185.625	1F	03

APPLICATIONS INFORMATION

Table 12. Quadrant 3 Phase Control—Mapping of I and Q VM VGA Register Settings to Phase Setting

Phase (Degrees)	I Reg (Hex)	Q Reg (Hex)
188.4375	1F	04
191.25	1F	06
194.0625	1E	07
196.875	1E	08
199.6875	1D	0A
202.5	1D	0B
205.3125	1C	0D
208.125	1C	0E
210.9375	1B	0F
213.75	1A	10
216.5625	19	11
219.375	18	13
222.1875	17	14
225	16	15
227.8125	15	16
230.625	14	17
233.4375	13	18
236.25	12	18
239.0625	10	19
241.875	0F	1A
244.6875	0E	1A
247.5	0C	1B
250.3125	0B	1C
253.125	0A	1C
255.9375	08	1C
258.75	07	1D
261.5625	05	1D
264.375	04	1D
267.1875	02	1D

Table 13. Quadrant 4 Phase Control—Mapping of I and Q VM VGA Register Settings to Phase Setting

Phase (Degrees)	I Reg (Hex)	Q Reg (Hex)
270	01	1D
272.8125	21	1D
275.625	23	1D
278.4375	24	1D
281.25	26	1D
284.0625	27	1C
286.875	28	1C
289.6875	2A	1C
292.5	2B	1B
295.3125	2D	1A
298.125	2E	1A
300.9375	2F	19
303.75	31	18
306.5625	32	18
309.375	33	17

Table 13. Quadrant 4 Phase Control—Mapping of I and Q VM VGA Register Settings to Phase Setting

Phase (Degrees)	I Reg (Hex)	Q Reg (Hex)
312.1875	34	16
315	36	15
317.8125	37	14
320.625	38	13
323.4375	39	11
326.25	39	10
329.0625	3A	0F
331.875	3B	0E
334.6875	3C	0D
337.5	3C	0B
340.3125	3D	0A
343.125	3E	08
345.9375	3E	07
348.75	3E	06
351.5625	3F	04
354.375	3F	03
357.1875	3F	01

TRANSMIT AND RECEIVE SUBCIRCUIT CONTROL

The TR_SOURCE bit (Bit 2, Register 0x031) determines whether the TR pin or the SPI registers controls the switching between transmit or receive modes for the ADAR1000. If the TR input is selected, the transmit and receive subcircuit enables are completely controlled by the TR pin. If SPI control is selected, any combination of receive subcircuits or transmit subcircuits can be turned on at a given time. Note that transmit and receive subcircuits cannot be turned on simultaneously.

SPI Control (TR_SOURCE = 0)

The TR_SPI bit (Bit 1, Register 0x031) controls the device transmit or receive mode. Register 0x02E, Register 0x02F, and Register 0x031 of the SPI registers turn the transmit and receive subcircuits on and off together. Typical operating mode is to set all channel and subcircuit enables active (that is, set Register 0x02E to 0x7F and Register 0x02F to 0x7F), and then use TX_EN and RX_EN (Bits[6:5] of Register 0x31, respectively) to turn on either the transmit subcircuits or receive subcircuits, and toggle TR_SPI appropriately with the TX_EN and RX_EN bits.

TR Pin Control (TR_SOURCE = 1)

When TR_SOURCE = 1, if the TR input is at logic low, the device goes into receive mode and all receive subcircuits are turned on. If the TR input is at logic high, the device goes into transmit mode, and all transmit subcircuits turn on. As a result, all transmit and receive switching functionality are completely controlled by a single pin.

APPLICATIONS INFORMATION

TRANSMIT AND RECEIVE SWITCH DRIVER CONTROL

The TR_SW_NEG and TR_SW_POS pins are the output pins that control the external switches that determine the signal flow direction between the transmit and receive modes that the ADAR1000 operates in. Several register bits and the TR pin work together to provide different ways to control the state of the TR_SW_NEG and TR_SW_POS pins. Note that either the TR_SW_NEG pin or the TR_SW_POS pin is operational at any given time when the SW_DRV_EN_TR bit is asserted. When the SW_DRV_EN_TR bit is deasserted, both pins are floating.

To enable the switch drivers, set the SW_DRV_EN_TR bit (Bit 4, Register 0x031) to logic high.

The SW_DRV_TR_STATE bit (Bit 7, Register 0x031) determines the polarity of these switch driver outputs (TR_SW_POS and TR_SW_NEG) with respect to transmit and receive mode. Allowing the polarity to be programmable provides additional flexibility when using different transmit and receive switch control configurations (see Table 14).

Table 14. Controlling TR_SW_POS and TR_SW_NEG Output

SW_DRV_EN_TR (Register 0x031, Bit 4)	TR_SOURCE (Register 0x031, Bit 2) ¹	TR (Chip Input) ¹	TR_SPI (Register 0x031, Bit 1) ¹	SW_DRV_TR_ MODE_SEL(Register 0x030, Bit 7) ¹	Device State ¹ Transmit/ Receive	SW_DRV_TR_ STATE (Register 0x031, Bit 7) ¹	TR_SW_POS (Chip Output)	TR_SW_NEG (Chip Output)
0	X	X	X	X	X	X	Floating	Floating
1	0	X	0	0	Receive	0	0 V	Floating
1	0	X	0	0	Receive	1	3.3 V	Floating
1	0	X	1	0	Transmit	0	3.3 V	Floating
1	0	X	1	0	Transmit	1	0 V	Floating
1	1	0	X	0	Receive	0	0 V	Floating
1	1	0	X	0	Receive	1	3.3 V	Floating
1	1	1	X	0	Transmit	0	3.3 V	Floating
1	1	1	X	0	Transmit	1	0 V	Floating
1	0	X	0	1	Receive	0	Floating	0 V
1	0	X	0	1	Receive	1	Floating	-5 V
1	0	X	1	1	Transmit	0	Floating	-5 V
1	0	X	1	1	Transmit	1	Floating	0 V
1	1	0	X	1	Receive	0	Floating	0 V
1	1	0	X	1	Receive	1	Floating	-5 V
1	1	1	X	1	Transmit	0	Floating	-5 V
1	1	1	X	1	Transmit	1	Floating	0 V

¹ X means don't care.

APPLICATIONS INFORMATION

PA BIAS OUTPUT CONTROL

The four PA bias output voltages (PA_BIAS1, PA_BIAS2, PA_BIAS3, and PA_BIAS4) are controlled by four separate DACs,

which in turn are controlled by a combination of inputs (note that some inputs are don't care depending on the settings).

See [Table 16](#) for all control combinations.

Table 15. PA Bias Output Control by Inputs

Input	Bit/Pin Name	Description
Register 0x30 Bit 6	BIAS_CTRL	Determines if the bias DACs always use the EXT_PAx_BIAS_ON data for each channel (BIAS_CTRL = 0) or if the bias DACs can be controlled with the other inputs (BIAS_CTRL = 1).
Register 0x31 Bit 2	TR_SOURCE	Determines whether switching between transmit and receive mode is controlled by the SPI register or the TR input.
Bit 6	TX_EN	Global transmit enable. Logic high enables all four transmit paths (if individual Chx_TX_EN bits are also logic high). See Figure 94 .
Register 0x029 to Register 0x02C or from Several locations in memory; see the memory map on the ADAR1000 product page.	EXT_PAx_BIAS_ON	External PA Bias on data that can be sourced from multiple locations.
Register 0x046 to Register 0x049 or from Several locations in memory; see the memory map on the ADAR1000 product page.	EXT_PAx_BIAS_OFF	External PA Bias off data that can be sourced from multiple locations.
Input Pins	TR PA_ON	Determines transmit or receive mode of chip when TR_SOURCE = 1. Determines whether to use the CHx_PA_BIAS_ON or CHx_PA_BIAS_OFF value when the ADAR1000 is in transmit mode, BIAS_CTRL is set to 1, and in TR pin control.

Table 16. Control of PA Bias Outputs

BIAS_CTRL (Register 0x030, Bit 6)	TR_SOURCE (Register 0x031, Bit 2)	TX_EN (Register 0x031, Bit 6)	TR (Input to Chip)	PA_ON (Input to Chip)	PA Bias Bits Used (x = 1, 2, 3, or 4)
0	X ¹	X ¹	X ¹	X ¹	EXT_PAx_BIAS_ON
1	0	0	X ¹	X ¹	EXT_PAx_BIAS_OFF
1	0	1	X ¹	X ¹	EXT_PAx_BIAS_ON
1	1	0	0	X ¹	EXT_PAx_BIAS_OFF
1	1	0	1	0	EXT_PAx_BIAS_OFF
1	1	0	1	1	EXT_PAx_BIAS_ON

¹ X means don't care.

APPLICATIONS INFORMATION

LNA BIAS OUTPUT CONTROL

The LNA_BIAS output voltage is controlled by a DAC, which in turn is controlled by a combination of inputs (see [Table 17](#)).

The output is set by the LNA_BIAS_ON data when the ADAR1000 is in receive mode or LNA_BIAS_OFF data when in transmit mode, if BIAS_CTRL is set to 1. If BIAS_CTRL set to 0, the output is set by LNA_BIAS_ON data. See [Table 18](#) for all control combinations.

Table 17. LNA Bias Output Control by Inputs

Input	Bit/Pin Name	Description
Register 0x30		
Bit 4	LNA_BIAS_OUT_EN	The LNA_BIAS output is enabled if LNA_BIAS_OUT_EN = 1. If LNA_BIAS_OUT_EN = 0, the output is open (three-state).
Bit 6	BIAS_CTRL	Determines if the bias DAC always use the EXT_LNA_BIAS_ON data (BIAS_CTRL = 0) or if the bias DAC can be controlled with the other inputs (BIAS_CTRL = 1).
Register 0x31		
Bit 2	TR_SOURCE	Determines whether switching between transmit and receive mode is controlled by the SPI register or the TR input.
Bit 6	RX_EN	Global receive enable. Logic high enables all four receive paths (if individual Chx_RX_EN bits are also logic high). See Figure 93 .
Register 0x2D or from Several locations in memory; see the memory map on the ADAR1000 product page.	EXT_LNA_BIAS_ON	External LNA Bias on data that can be sourced from multiple locations.
Register 0x4A or from Several locations in memory; see the memory map on the ADAR1000 product page.	EXT_LNA_BIAS_OFF	External LNA Bias off data that can be sourced from multiple locations.
Input Pin	TR	Determines transmit or receive mode of chip when TR_SOURCE = 1

Table 18. Control of LNA_BIAS Output

LNA_BIAS_OUT_EN (Register 0x030, Bit 4)	BIAS_CTRL (Register 0x030, Bit 6)	TR_SOURCE (Register 0x031, Bit 2)	RX_EN (Register 0x031, Bit 5)	TR (Input to Chip)	LNA Bias Bits Used
0	X ¹	X ¹	X ¹	X ¹	Open circuit (floating)
1	0	0	0	X ¹	EXT_LNA_BIAS_ON
1	0	0	1	X ¹	EXT_LNA_BIAS_ON
1	1	0	0	X ¹	EXT_LNA_BIAS_OFF
1	1	0	1	X ¹	EXT_LNA_BIAS_ON
1	0	1	0	0	EXT_LNA_BIAS_ON
1	0	1	0	1	EXT_LNA_BIAS_ON
1	1	1	0	0	EXT_LNA_BIAS_ON
1	1	1	0	1	EXT_LNA_BIAS_OFF

¹ X means don't care.

APPLICATIONS INFORMATION

PA BIAS, LNA BIAS, AND SWITCH BIAS SETUP EXAMPLES

Upon setup, all three sets of bias pins can either be controlled with either the TR pin or with the SPI. Note the state of all the bias pins upon power-up.

- ▶ The PA_BIASx pins assume the EXT_PAx_BIAS_ON values upon power-up. That is, all PA_BIASx pins are driven to 0 V.
- ▶ The LNA_BIAS pin is floating upon power-up.
- ▶ TR_SW_POS and TR_SW_NEG are floating upon power-up.

PA Bias Setup for TR Pin Control Example

Pull TR pin low to put the ADAR1000 into receive mode after TR pin control is established. See [Table 19](#) for the bit settings.

Table 19. Bias Bit Settings for TR Pin Control

Register/Bit	Bit Setting	Description
Register 0x30, Bit 6	BIAS_CTRL = 1	Enables control of bias pins.
Register 0x31, Bit 2	TR_SOURCE = 1	The TR pin controls transmit or receive device mode.
Register 0x38, Bit 5	BIAS_RAM_BYPASS = 1	Source all bias data from registers.

Set the desired bias on and bias off values for the external PAs in the following registers:

- ▶ Register 0x29: EXT_PA1_BIAS_ON
- ▶ Register 0x2A: EXT_PA2_BIAS_ON
- ▶ Register 0x2B: EXT_PA3_BIAS_ON
- ▶ Register 0x2C: EXT_PA4_BIAS_ON
- ▶ Register 0x46: EXT_PA1_BIAS_OFF
- ▶ Register 0x47: EXT_PA2_BIAS_OFF
- ▶ Register 0x48: EXT_PA3_BIAS_OFF
- ▶ Register 0x49: EXT_PA4_BIAS_OFF

After pulling the TR pin low and making these SPI writes, the PA_BIASx pins assume the EXT_PAx_BIAS_OFF values. Pulling the TR pin high causes the PA_BIASx pins to assume the EXT_PAx_BIAS_ON values. This setup example assumes that the PA_ON pin is pulled high.

PA Bias Setup for SPI Control Example

Set the bits as shown in [Table 20](#).

Table 20. Bias Bit Settings for SPI Control

Register/Bit	Bit Setting	Description
Register 0x30, Bit 6	BIAS_CTRL = 1	Enables control of bias pins.
Register 0x31		

Table 20. Bias Bit Settings for SPI Control

Register/Bit	Bit Setting	Description
Bit 1	TR_SPI = 0	Puts the ADAR1000 into Rx mode.
Bit 2	TR_SOURCE = 0	SPI controls transmit or receive device mode.
Bit 5	RX_EN = 1	Enable receive paths.
Bit 6	TX_EN = 0	Disables transmit paths.
Register 0x38, Bit 5	BIAS_RAM_BYPASS = 1	Source all bias data from registers.

Set the desired bias on and bias off values for the external PAs in the following registers:

- ▶ Register 0x29: EXT_PA1_BIAS_ON
- ▶ Register 0x2A: EXT_PA2_BIAS_ON
- ▶ Register 0x2B: EXT_PA3_BIAS_ON
- ▶ Register 0x2C: EXT_PA4_BIAS_ON
- ▶ Register 0x46: EXT_PA1_BIAS_OFF
- ▶ Register 0x47: EXT_PA2_BIAS_OFF
- ▶ Register 0x48: EXT_PA3_BIAS_OFF
- ▶ Register 0x49: EXT_PA4_BIAS_OFF

After making these SPI writes, the PA_BIASx pins assume the EXT_PAx_BIAS_OFF values. Setting TX_EN = 1 causes the PA_BIASx pins to assume the EXT_PAx_BIAS_ON values. It is important to note that the PA_BIASx pins follow the TX_EN bit, not the TR_SPI bit, while in SPI control.

The state of the TR and PA_ON pins have no effect on the PA_BIASx pins while in SPI control mode.

LNA Bias Setup for TR Pin Control Example

Pull TR pin low to put the ADAR1000 into receive mode after TR pin control is established. Set the bits as shown in [Table 21](#).

Table 21. LNA Bias Bit Settings for TR Pin Control

Register/Bit	Bit Setting	Description
Register 0x30		
Bit 4	LNA_BIAS_OUT_EN = 1	Enables LNA bias driver.
Bit 6	BIAS_CTRL = 1	Enables control of bias pins.
Register 0x31		
Bit 2	TR_SOURCE = 1	TR pin controls transmit or receive device mode.
Register 0x38, Bit 5	BIAS_RAM_BYPASS = 1	Source all bias data from registers.

Set the desired bias on and bias off values for the external LNA in the following registers:

- ▶ Register 0x2D: EXT_LNA_BIAS_ON
- ▶ Register 0x4A: EXT_LNA_BIAS_OFF

APPLICATIONS INFORMATION

After pulling the TR pin low and making these SPI writes, the LNA_BIAS pin assumes the EXT_LNAX_BIAS_ON value. Pulling the TR pin high causes the LNA_BIAS pin to assume the EXT_LNAX_BIAS_OFF values.

LNA Bias Setup for SPI Control Example

Set the bits as shown in [Table 22](#).

Table 22. LNA Bias Bit Settings for SPI Control

Register/Bit	Bit Setting	Description
Register 0x30		
Bit 4	LNA_BIAS_OUT_EN = 1	Enables LNA bias driver.
Bit 6	BIAS_CTRL = 1	Enables control of bias pins.
Register 0x31		
Bit 1	TR_SPI = 0	Puts the ADAR1000 into receive mode.
Bit 2	TR_SOURCE = 0	SPI controls transmit or receive device mode.
Bit 5	RX_EN = 1	Enable receive paths.
Bit 6	TX_EN = 0	Disables transmit paths.
Register 0x38, Bit 5	BIAS_RAM_BYPASS = 1	Source all bias data from registers.

Set the desired bias on and bias off values for the external LNA in the following registers:

- ▶ Register 0x2D: EXT_LNA_BIAS_ON
- ▶ Register 0x4A: EXT_LNA_BIAS_OFF

After making these SPI writes, the LNA_BIAS pin assumes the EXT_LNAX_BIAS_ON value. Setting RX_EN = 0 causes the LNA_BIAS pin to assume the EXT_LNAX_BIAS_OFF values. It is important to note that the LNA_BIAS pin follows the RX_EN bit, not the TR_SPI bit, while in SPI control.

Allowable PA and LNA States While in SPI Control

The external bias pins, PA_BIASx and LNA_BIAS, follow the TX_EN and RX_EN bits, respectively, while in SPI control. While the ADAR1000 is controlling external PAs and/or LNAs, the user should either assert TX_EN or RX_EN high, but not both. In a power-down mode, both bits are set to low. However, both TX_EN and RX_EN can be asserted high. In this case, both the PA_BIASx and LNA_BIAS pins assume the values in their bias on registers. [Table 23](#) outlines the four possible bias cases.

Table 23. Possible External Bias States While in SPI Control

Tx_EN	Rx_EN	PA Bias Bits Used	LNA Bias Bit Used
0	0	EXT_PAx_BIAS_OFF	EXT_LNA_BIAS_OFF
0	1	EXT_PAx_BIAS_OFF	EXT_LNA_BIAS_ON
1	0	EXT_PAx_BIAS_ON	EXT_LNA_BIAS_OFF
1	1	EXT_PAx_BIAS_ON	EXT_LNA_BIAS_ON

Note that the device mode, and thus the transmit/receive switch, is controlled with the TR_SPI bit. If TX_EN and RX_EN are both high, the external PAs and LNA are biased on, but the external transmit/receive switch can either be in transmit mode or receive mode, controlled by the TR_SPI bit. Note that in this situation, the external paths are powered up, but the ADAR1000 powers down its subcircuits when both TX_EN and RX_EN are high.

Switch Bias Setup for TR Control Example

Pull the TR pin low to put the ADAR1000 into receive mode after TR pin control is established.

The user must choose between TR_SW_POS and TR_SW_NEG because their operation is mutually exclusive, by setting SW_DRV_TR_MODE_SEL (Bit 7 in Register 0x30).

- ▶ When SW_DRV_TR_MODE_SEL = 0, TR_SW_POS is selected
- ▶ When SW_DRV_TR_MODE_SEL = 1, TR_SW_NEG is selected

Set the following bits in Register 0x31, as shown in [Table 24](#).

Table 24. Register 0x31 Bit Settings for Switch Bias Setup

Bit	Bit Setting	Description
Bit 2	TR_SOURCE = 1	TR pin controls transmit or receive device mode
Bit 4	SW_DRV_EN_TR = 1	Enables positive and negative switch drivers
Bit 7	SW_DRV_TR_STATE = 1	Sets switch driver polarity relative to transmit or receive mode

If SW_DRV_TR_MODE_SEL = 0,

- ▶ TR_SW_POS = 3.3 V while in receive mode (TR low)
- ▶ TR_SW_POS = 0 V while in transmit mode (TR high)

If SW_DRV_TR_MODE_SEL = 1,

- ▶ TR_SW_NEG = -5V while in receive mode (TR low)
- ▶ TR_SW_NEG = 0V while in transmit mode (TR high)

Note that the switch bias outputs follow the TR pin while in TR pin control.

Switch Bias Setup for SPI Control Example

The user must choose between the TR_SW_POS and TR_SW_NEG switch bias outputs, because their operation is mutually exclusive, by setting SW_DRV_TR_MODE_SEL (Bit 7 in Register 0x30).

- ▶ When SW_DRV_TR_MODE_SEL = 0, TR_SW_POS selected
- ▶ When SW_DRV_TR_MODE_SEL = 1, TR_SW_NEG selected

Set the following bits in Register 0x31, as shown in [Table 24](#).

Table 25. Register 0x31 Bit Settings for Switch Bias Setup, SPI Control

Bit	Bit Setting	Description
Bit 1	TR_SPI = 0	Puts ADAR1000 in receive mode.

APPLICATIONS INFORMATION

Table 25. Register 0x31 Bit Settings for Switch Bias Setup, SPI Control

Bit	Bit Setting	Description
Bit 2	TR_SOURCE = 0	SPI controls transmit or receive device mode
Bit 4	SW_DRV_EN_TR = 1	Enables positive and negative switch drivers
Bit 7	SW_DRV_TR_STATE = 1	Sets switch driver polarity relative to transmit or receive mode

If SW_DRV_TR_MODE_SEL = 0,

- ▶ TR_SW_POS = 3.3 V while in receive mode (TR_SPI = 0)
- ▶ TR_SW_POS = 0 V while in transmit mode (TR_SPI = 1)

If SW_DRV_TR_MODE_SEL = 1,

- ▶ TR_SW_NEG = -5 V while in receive mode (TR_SPI = 0)
- ▶ TR_SW_NEG = 0V while in transmit mode (TR_SPI = 1)

Note that while in SPI control,

- ▶ The switch bias outputs follow the TR_SPI bit.
- ▶ The state of the TR pin has no effect on the switch bias outputs.

TRANSMIT/RECEIVE DELAY CONTROL

The delays between switching from transmit to receive and receive to transmit, Delay 1 and Delay 2, are controlled via Register 0x4B and Register 0x4C, respectively. The delay time is proportional to the SPI clock period. With a 50 ns clock period (20 MHz), the maximum value for either Delay 1 or Delay 2 is 750 ns. This delay value corresponds to a delay code of 15 or 0xF in either the top and/or bottom nibbles of Register 0x4B and Register 0x4C. A delay value of 0 corresponds to 0 ns delay, a delay value of 1 corresponds to 50 ns, a delay value of 2 corresponds to 100 ns, and so on. Note that Delay 1 and/or Delay 2 only take effect when all of the following conditions are met:

- ▶ When in TR pin control
- ▶ When SCLK is applied after the TR pin changes state
- ▶ When all the delay values in Register 0x4B and Register 0x4C are nonzero

The exact transmit to receive sequence is as follows:

1. The TR pin changes state from high to low.
2. The PA_BIASx pins change state from their on value to off value. Transmit subcircuits power down.
3. The delay set by TX_TO_RX_DELAY_1 occurs.
4. The internal transmit/receive switches switch to receive position. TR_SW_POS or TR_SW_NEG changes state.
5. The delay set by TX_TO_RX_DELAY_2 occurs.
6. The LNA_BIAS pin changes state from off to on value. Receive subcircuits power up.

The exact receive to transmit sequences is as follows:

1. The TR pin changes state from low to high.
2. The LNA_BIAS pin changes state from on to off value. Receive subcircuits power down.
3. The delay set by RX_TO_TX_DELAY_1 occurs.
4. The internal transmit/receive switches switch to transmit position. TR_SW_POS or TR_SW_NEG changes state.
5. The delay set by RX_TO_TX_DELAY_2 occurs.
6. The PA_BIASx pins change state from their off value to on value. Transmit subcircuits power up.

PA Bias Silicon Error When Using Delay

A silicon error exists that prevents all four of the PA bias pins from changing state (from either their off to on value or on to off value) after the TR pin changes its state, when delay values in Register 0x4B and Register 0x4C are all nonzero. This error means that the PA bias pins stay at the same state as they were before the delays were programmed, and limits the PA bias control to either their on value or off value when switching from transmit to receive or receive to transmit. If external PA bias control is required with a delay, an external alternative bias scheme must be used.

Transmit and Receive Mode Switching

Figure 96 shows the timing for transmit and receive mode switching.

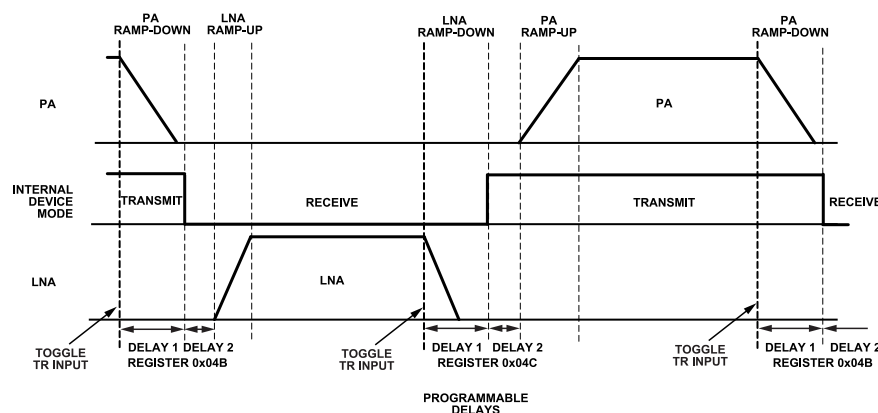

Figure 96. Timing for Transmit and Receive Mode Switching

APPLICATIONS INFORMATION

ADAR1000 AND ADTR1107

The ADAR1000 is designed to work with the [ADTR1107](#) front-end IC transmit and receive module. The ADAR1000 can connect to and control four ADTR1107s. Once the ADAR1000 and ADTR1107 are powered up and SPI writes occur for the necessary ADAR1000 setup, only the TR pin on the ADAR1000 needs to be used to control the following:

- ▶ Receive or transmit mode on both devices
- ▶ ADAR1000 path enabling and disabling
- ▶ ADTR1107 PA and LNA gate bias on and off voltage levels

See the [Transmit/Receive Delay Control](#) section for more information.

Interfacing

The ports of each device are designed for glueless interfacing, requiring no components between the connected ports. The RF ports are strategically located on both devices to enable layout routing without crisscrossing the RF lines. This interface is shown schematically in [Figure 97](#).

Also shown in [Figure 97](#) are the ADAR1000 PA bias, LNA bias, and switch bias pins driving the ADTR1107 PA gate, LNA gate, and switch control pins, respectively. Note that there is a dedicated PA

bias pin for each connected ADTR1107, but only a single LNA bias pin drives four ADTR1107 devices.

Supply and Bias Sequencing

The ADTR1107 requires specific bias up and bias down sequences for its four supply voltages, two gate biases, and switch control. On an application board, the ADAR1000 and ADTR1107 can share the 3.3 V supply, which is assumed going forward. The ADTR1107 PA gate bias depends on the ADAR1000 -5 V supply powering up first before the PA VDD is powered on. The following is the proper power-up and biasing sequence when the ADAR1000 is connected to the ADTR1107.

1. Connect a 3.3 V supply to the ADTR1107 via VDD_SW and VDD_LNA and to the ADAR1000 main supply.
2. Connect a -3.3 V supply to the ADTR1107 via VSS_SW.
3. Set the ADAR1000 TR_SW_POS pin to drive the ADTR1107 CTRL_SW pin.
4. Connect a -5 V supply to ADAR1000 as the secondary supply.
5. Set the ADAR1000 PA_BIASx pins to -2.5 V to drive the ADTR1107 VGG_PA.
6. Connect a 5 V supply to the ADTR1107 VDD_PA pin.

The following sections detail how to properly set the various bias pins during the power-up procedure.

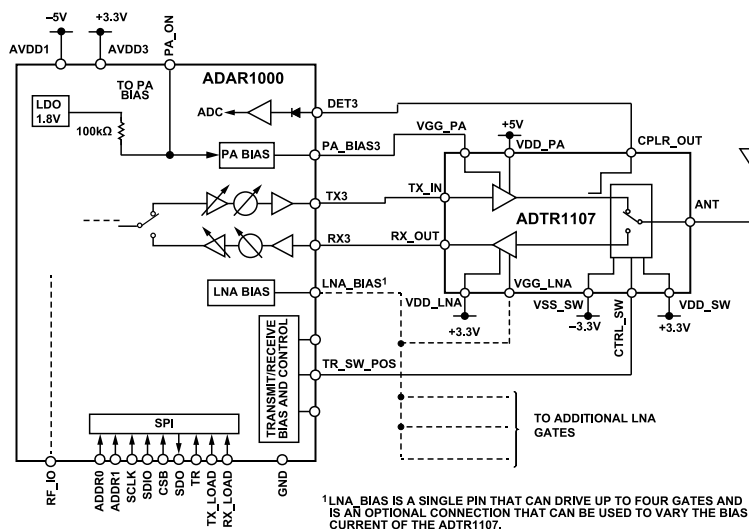

Figure 97. Interfacing the ADAR1000 to the ADTR1107; One Channel Shown

APPLICATIONS INFORMATION

Setting the ADAR1000 TR_SW_POS

When powering up the ADAR1000 and ADTR1107 together, the TR_SW_POS pin is the first bias pin that must be set in the sequence. To set this pin after bringing up the +3.3 V and -3.3 V supply voltages while in TR control, follow these steps:

1. Pull the TR pin low.
2. In Register 0x31, set TR_SOURCE = 1 (Bit 2), SW_DRV_EN_TR = 1 (Bit 4), and SW_DRV_TR_STATE = 1 (Bit 7).

Pulling the TR pin low and setting the Register 0x31 bits puts the ADAR1000 in receive mode and sets the TR_SW_POS pin to 3.3 V, which, when driving the ADTR1107 CTRL_SW pin, also puts the ADTR1107 in receive mode.

If in SPI control, set the following bits in Register 0x31 to set TR_SW_POS:

- ▶ Bit 1: TR_SPI = 0
- ▶ Bit 2: TR_SOURCE = 0
- ▶ Bit 4: SW_DRV_EN_TR = 1
- ▶ Bit 7: SW_DRV_TR_STATE = 1

Setting the Register 0x31 bits puts the ADAR1000 in receive mode and sets the TR_SW_POS pin to 3.3 V, which, when driving the ADTR1107 CTRL_SW pin, also puts the ADTR1107 in receive mode.

All other bits not mentioned are assumed to be default values.

Setting the ADAR1000 PA_BIASx Pins

For safe power up of the ADTR1107 PA, the PA_BIASx bias pins must be set to -2.5 V before the +5 V supply is powered up. Once the -5 V supply for the ADAR1000 is powered up, the user can make the following SPI writes if in TR control:

1. Set Bit 6 in Register 0x30, BIAS_CTRL = 1.
2. Set Bit 5 in Register 0x38, BIAS_RAM_BYPASS = 1
3. Set the data in Register 0x29, Register 0x2A, Register 0x2B, and Register 0x2C for approximately -1.1 V, with EXT_PAx_BIAS_ON = 0x39 (where x = 1, 2, 3, or 4).
4. Set the data in Register 0x46, Register 0x47, Register 0x48, and Register 0x49 for approximately -2.5 V, with EXT_PAx_BIAS_OFF = 0x85 (where x = 1, 2, 3, or 4).

With TR low, all PA_BIASx pins are set to approximately -2.5 V, which is a safe voltage for the VGG_PA pins when the +5 V supply is powered up. After the +5 V supply is powered up, TR can be pulled high, which sets all the PA_BIASx pins to approximately -1.1 V, which in turn sets the ADTR1107 PA bias current to 220 mA.

If in SPI control, to set the PA_BIASx pins, follow these steps:

1. Set Bit 6 in Register 0x30, BIAS_CTRL = 1.
2. Set Bit 6 in Register 0x31, TX_EN = 0.

3. Set Bit 5 in Register 0x38, BIAS_RAM_BYPASS = 1.
4. Set the data in Register 0x29, Register 0x2A, Register 0x2B, and Register 0x2C for approximately -1.1 V, with EXT_PAx_BIAS_ON = 0x39 (where x = 1, 2, 3, or 4).
5. Set the data in Register 0x46, Register 0x47, Register 0x48, and Register 0x49 for approximately -2.5 V, with EXT_PAx_BIAS_OFF = 0x85 (where x = 1, 2, 3, or 4).

With TX_EN = 0, all PA_BIASx pins are set to approximately -2.5 V, which is a safe voltage for the VGG_PA pins when the +5 V supply is powered up. After the +5 V supply is powered up, setting TX_EN = 1 sets all the PA_BIASx pins to approximately -1.1 V, which in turn sets the ADTR1107 PA bias current to 220 mA.

All other bits not mentioned maintain their values from the [Setting the ADAR1000 TR_SW_POS](#) section.

Setting the ADAR1000 LNA_BIAS Pin

Connecting the ADAR1000 LNA_BIAS pin to the ADTR1107 VGG_LNA is optional because the ADTR1107 LNA is self biased. However, if a different LNA bias setting is desired or if the LNA must be debiased while in transmit mode, perform the following writes to drive the VGG_LNA if in TR control:

1. Set Bit 4 in Register 0x30, LNA_BIAS_OUT_EN = 1.
2. Set the data in Register 0x2D for 0 V, with EXT_LNA_BIAS_ON = 0x00.
3. Set the data in Register 0x4A for approximately -2 V, with EXT_LNA_BIAS_OFF = 0x68.

With TR low and after making these SPI writes, the LNA_BIAS pin is at 0 V. Taking TR high causes the LNA_BIAS pin to be at approximately -2 V.

If in SPI control, to set the LNA_BIAS pin, follow these steps:

1. Set Bit 4 in Register 0x30, LNA_BIAS_OUT_EN = 1.
2. Set Bit 5 in Register 0x31, RX_EN = 1.
3. Set the data in Register 0x2D for 0 V, with EXT_LNA_BIAS_ON = 0x00.
4. Set the data in Register 0x4A for approximately -2 V, with EXT_LNA_BIAS_OFF = 0x68.

After making these SPI writes, the LNA_BIAS pin is at 0 V. Taking RX_EN = 0 causes the LNA_BIAS pin to be at approximately -2 V.

All other bits not mentioned maintain their values from the [Setting the ADAR1000 PA_BIASx Pins](#) section.

POWERING THE ADAR1000

The ADAR1000 has two power supply domains, +3.3V and -5 V. These power supplies can be driven with the synchronous step down regulator [LT8609S](#) and the inverting dc-to-dc converter [LT3462](#), respectively. With a single 5.5 V supply driving both the [LT8609S](#) and [LT3462](#), the [LT8609S](#) generates the +3.3 V supply, while the [LT3462](#) generates the -5 V supply.

APPLICATIONS INFORMATION

A single ADAR1000 is tested using the LT8609S and LT3462. Figure 98 and Figure 99 show the rise and fall times of the LNA_BIAS pin under a maximum load condition of -10 mA. Figure 100 and Figure 101 show the rise and fall times of all four PA_BIASx pins, each with a maximum load condition of -10 mA. A simplified block diagram of the test setup for the LT8609S and LT3462 is shown in Figure 102.

If more than two ADAR1000 devices must be powered, and if the user does not want multiple LT8609S and LT3462 devices, there are several solutions that power from four to 64 ADAR1000 devices by using a single chip per voltage supply. Table 26 shows these solutions by providing the quantity of ADAR1000 devices and the corresponding chips required to power multiple ADAR1000 devices.

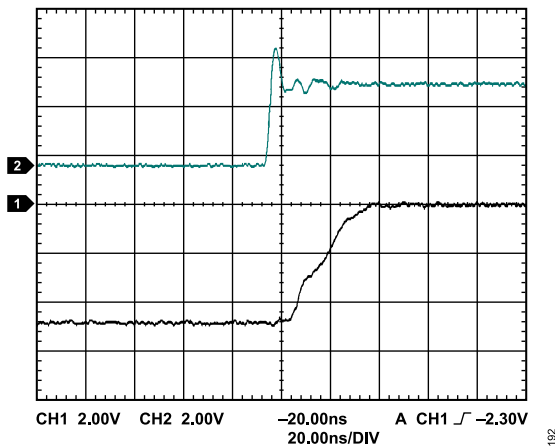

Figure 98. LNA_BIAS Rise Time; -10 mA Load, Measured on P9A of ADAR1000-EVALZ

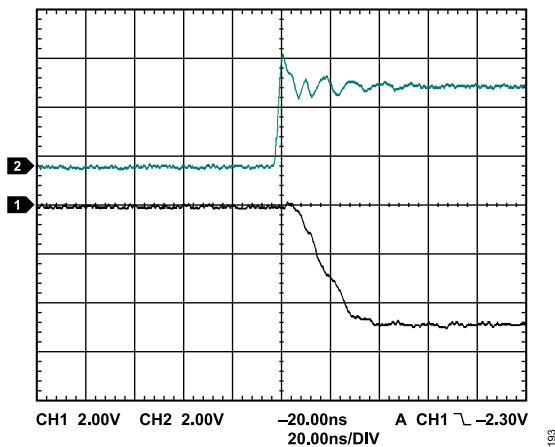

Figure 99. LNA_BIAS Fall Time; -10 mA Load, Measured on P9A of ADAR1000-EVALZ

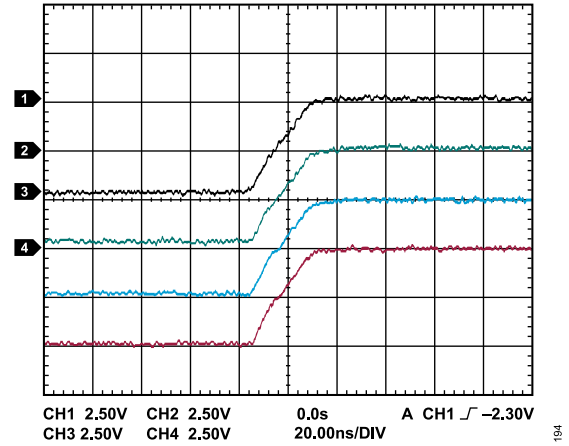

Figure 100. PA_BIAS1, PA_BIAS2, PA_BIAS3, or PA_BIAS 4 Rise Time; -10 mA Load, Measured on P9A of ADAR1000-EVALZ

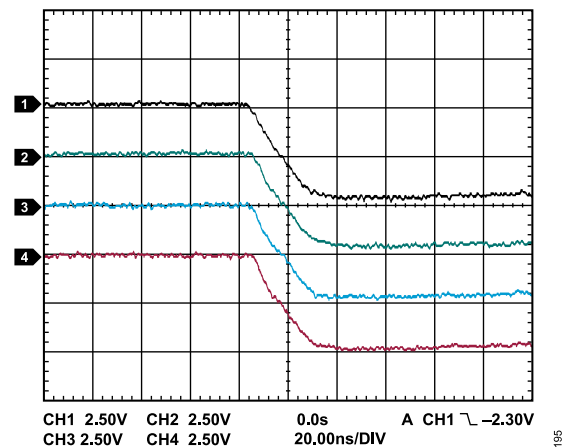

Figure 101. PA_BIAS1, PA_BIAS2, PA_BIAS3, or PA_BIAS4 Fall Time; -10 mA Load, Measured on P9A of ADAR1000-EVALZ

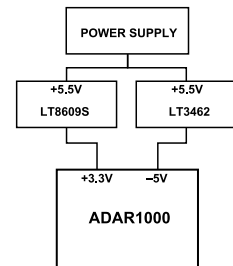

Figure 102. Block Diagram of the LT8609S and the LT3462 Powering the ADAR1000

Table 26. Power Solutions for Multiple ADAR1000 Devices

ADAR1000 Quantity	Supplying +3.3 V	Supplying -5 V
4	LT8609S	LT1931
16	LT8642S	LT3580
32	LTC7151S	LT3957A
64	LTM4636	LT3757

APPLICATIONS INFORMATION

RETURN LOSS WHILE POWERED DOWN

The ADAR1000 is designed to be a half-duplex (TDD) device, frequently switching between receive and transmit modes. Each time the device switches into receive mode, all the transmit subcircuits shut off. Similarly, when switching into transmit mode, all the receive subcircuits shut off.

There is a large amount of isolation between the RF_IO port and the nearest active circuitry. Therefore, the return loss for the common RF_IO port when powered down does not vary appreciably because this port is directly connected to the passive power combiner/splitter network. The return loss is shown in Figure 103.

Because there is active circuitry on all receive input ports and transmit output ports, the return loss varies when switching between receive and transmit modes. The difference in return loss between a receive port when powered off (chip reset state) and a receive port when the receive path is powered up in its nominal bias setting is shown in Figure 104. The difference in return loss between a transmit port when powered off (chip reset state) and a transmit port when the transmit path is powered up in its nominal bias setting is shown in Figure 105.

The increased mismatch due to the degradation of the return loss of the transmit ports while powered down is not a problem because there is no signal on the transmit ports while in this situation. This situation assumes the impedance mismatch presented to the input of the external PA does not cause any other issues, such as oscillations. However, there can be a signal on the receive ports when the receive paths are powered down if, for example, the off-chip LNA driving the receive port is not powered down as well. The user must ensure that the voltage standing wave ratio (VSWR) between each receive port and the device driving the receive port is within acceptable bounds.

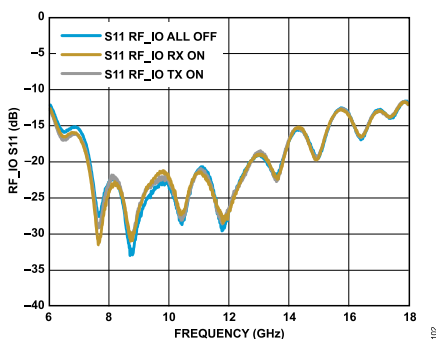

Figure 103. RF_IO Return Loss While Powered Up and Powered Down

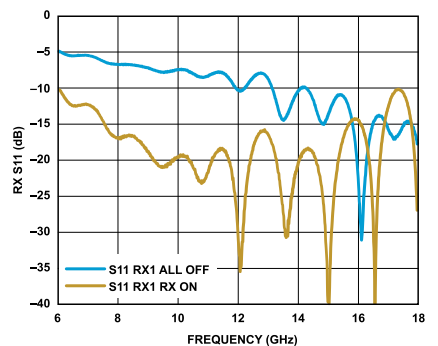

Figure 104. Receive Port Return Loss While Powered Up and Powered Down

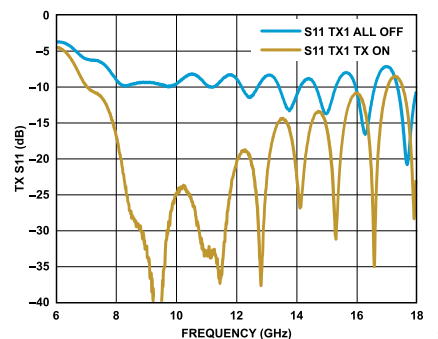

Figure 105. Transmit Return Loss While Powered Up and Powered Down

SPI CONSIDERATIONS

The ADAR1000 has a silicon error that prevents individual chip SPI readback when multiple chips share the SPI bus and all chips are in the same SPI mode (3-wire vs. 4-wire). To perform SPI readbacks properly, the Register 0x00 special functionality must be considered. The following sections detail how to use the special functionality of Register 0x00 to solve the readback issue. For the following sections, refer to Table 27

Table 27. Chip Index, and Corresponding Chip ID Bits and Pins

Chip Index	Address Bits[14:13]	ADDR1 Pin State	ADDR0 Pin State
Chip 0	0b00	Low	Low
Chip 1	0b01	Low	High
Chip 2	0b10	High	Low
Chip 3	0b11	High	High

Register 0x00

Register 0x00 has the following functionality:

- ▶ When issuing a soft reset to Chip 0, all chips on the SPI bus perform a soft reset.
- ▶ When issuing a soft reset to Chip 1, Chip 2, or Chip 3, no chips on the SPI bus reset.
- ▶ When asserting LSB first, address ascension, or the SDO active bits on Chip 0, all chips on the SPI bus are set to LSB first mode, address ascension mode, or SDO enabled, respectively.

APPLICATIONS INFORMATION

- ▶ When asserting LSB first, address ascension, or the SDO active bit on Chip x (x = 1, 2, or 3), only Chip x is set to LSB first mode, address ascension mode, or SDO enabled, respectively.

Soft reset does not affect Register 0x00. That is, LSB first, address ascension, and/or the SDO active bits can be asserted high in the same SPI write as the soft reset, and those bits remain high. The soft reset bits are self clearing.

Note that the reset of all chips on the SPI bus when a soft reset command is issued to Chip 0 is similar in behavior to the write all command when Address Bits[14:11] = 0b0001. However, these two functions are not interrelated, and serve different purposes.

SDO Readback Problem and Solution

The SDO readback problem is encountered whenever there is more than one ADAR1000 chip on the SPI bus. The SDO pins of the ADAR1000 chips, which are not issued a readback command, are not in tristate during the readback. When the SDO pins are not in tristate, the output drivers of the SDO pins erroneously pull low, which then overpowers the readback of the addressed chip, and causes the addressed chip to read back incorrectly. Damage to the SDO pins can happen during the bus contention. Refer to [SDO Bus Connections](#) for information about the SDO current limiting resistor to prevent damage.

For a 4-wire SPI, the general procedure is to leave the SDO pins disabled for the ADAR1000 chips that are not being issued a readback command, and only enable the ADAR1000 chip that is to be read back from. For 3-wire SPI mode, it is the opposite. Enable the SDO pin on the devices to be read back from, and disable SDO on the device that is not to be read back from. To read back from Chip 0, three additional writes are needed to Chip 1, Chip 2, and Chip 3 to set the SDO pin accordingly, depending on the SPI mode.

Example solutions for 4-wire and 3-wire SPI modes are detailed in [Table 28](#) and [Table 29](#). Both tables assume Chip 0 is on the SPI bus, LSB_FIRST is low, and ADDR_ASCN is low.

Table 28. 4-Wire SPI Mode—Chip 0, Chip 1, Chip 2, and Chip 3 Share SPI Bus

SPI Type	Address		Comments
	Bits	Data	
Write	0x0000	0x00	Disable SDO pin on all chips
Write	0x2000	0x18	Enable Chip 1 SDO pin
Write	0x200A	0xAA	Test write to Chip 1 scratchpad
Read	0xA00A	0xAA	Test read from Chip 1 scratchpad
Write	0x2000	0x00	Disable Chip 1 SDO
Write	0x400A	0xAA	Test write to Chip 2 scratchpad
Read	0xC00A	0xAA	Test read from Chip 2 scratchpad
Write	0x4000	0x00	Disable Chip 2 SDO
Write	0x600A	0xAA	Test write to Chip 3 scratchpad
Read	0xE00A	0xAA	Test read from Chip 3 scratchpad
Write	0x6000	0x00	Disable Chip 3 SDO
Write	0x0000	0x18	Enable SDO pin on all chips

Table 28. 4-Wire SPI Mode—Chip 0, Chip 1, Chip 2, and Chip 3 Share SPI Bus

SPI Type	Address		Comments
	Bits	Data	
Write	0x2000	0x00	Disable Chip 1 SDO pin
Write	0x4000	0x00	Disable Chip 2 SDO pin
Write	0x6000	0x00	Disable Chip 3 SDO pin
Write	0x000A	0xAA	Test write to Chip 0 scratchpad
Read	0x000A	0xAA	Test read from Chip 0 scratchpad
Write	0x0000	0x00	Disable SDO pin on all chips

Table 29. 3-Wire SPI Mode—Chip 0, Chip 1, Chip 2, and Chip 3 Share SPI Bus

SPI Type	Address		Comments
	Bits	Data	
Write	0x0000	0x18	Enable SDO pin on all chips
Write	0x2000	0x00	Disable Chip 1 SDO pin
Write	0x200A	0xAA	Test write to Chip 1 scratchpad
Read	0xA00A	0xAA	Test read from Chip 1 scratchpad
Write	0x2000	0x18	Enable Chip 1 SDO
Write	0x400A	0xAA	Test write to Chip 2 scratchpad
Read	0xC00A	0xAA	Test read from Chip 2 scratchpad
Write	0x4000	0x18	Enable Chip 2 SDO
Write	0x600A	0xAA	Test write to Chip 3 scratchpad
Read	0xE00A	0xAA	Test read from Chip 3 scratchpad
Write	0x6000	0x18	Enable Chip 3 SDO
Write	0x0000	0x00	Disable SDO pin on all chips
Write	0x2000	0x18	Enable Chip 1 SDO pin
Write	0x4000	0x18	Enable Chip 2 SDO pin
Write	0x6000	0x18	Enable Chip 3 SDO pin
Write	0x000A	0xAA	Test write to Chip 0 scratchpad
Read	0x000A	0xAA	Test read from Chip 0 scratchpad
Write	0x0000	0x18	Enable SDO pin on all chips

APPLICATIONS INFORMATION

SDO Bus Connections

The SDO pin has no internal current limiting resistor. When there are multiple SDO pins sharing the same SPI bus and when the readback procedures outlined in [Table 28](#) and [Table 29](#) are not followed, there is a possibility of damage to one or more of the SDO pins. It is recommended to install a 50 Ω series current limiting

resistor between the SDO pin and the MISO bus line as shown in [Figure 106](#). The setup gives incorrect logic levels during readback if the procedures are not followed, but it can prevent damage from occurring by limiting the sourced current to 27 mA when four chips share the SPI bus (current reduces if fewer chips are on the bus).

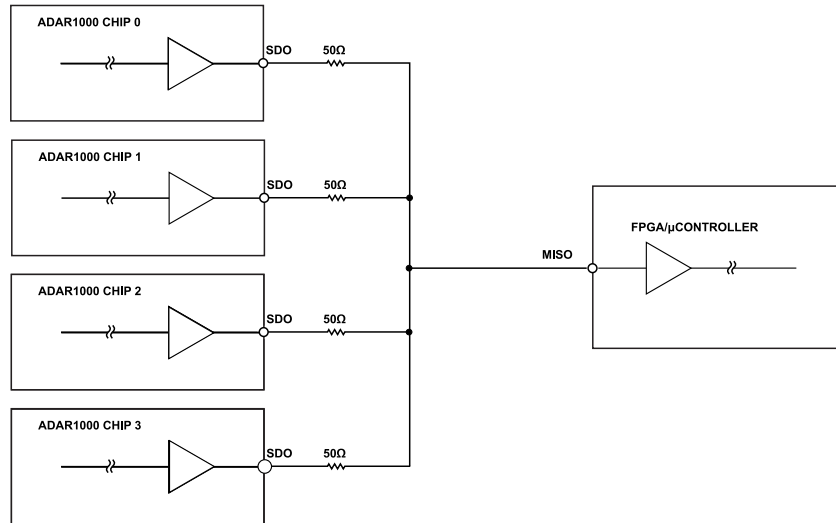

Figure 106. Recommended SDO Current Limiting Resistors

206

APPLICATIONS INFORMATION

SPI PROGRAMMING EXAMPLE

The SPI programming example in [Table 30](#) sets up the bias of the different subcircuits, as well as the gain and phase settings of all

channels. The device stays in the receive mode until the TR input is raised high, and the device switches into transmit mode. All the external amplifier bias and switches also change state accordingly.

Table 30. Register Programming to Set Up the ADAR1000

Register Address	Content (Hexadecimal)	Description
0x000	BD	Reset whole chip, use SDO line for readback, address auto incrementing in block write mode.
0x401	02	Allow LDO adjustments from user settings.
0x400	55	Adjust LDO regulators.
0x046	85	Set PA_BIAS1 output to approximately -2.5 V in receive mode.
0x047	85	Set PA_BIAS2 output to approximately -2.5 V in receive mode.
0x048	85	Set PA_BIAS3 output to approximately -2.5 V in receive mode.
0x049	85	Set PA_BIAS4 output to approximately -2.5 V in receive mode.
0x04A	68	Set LNA_BIAS output to approximately -2 V while in transmit mode
0x029	39	Set PA_BIAS1 output to approximately -1.1 V in transmit mode.
0x02A	39	Set PA_BIAS2 output to approximately -1.1 V in transmit mode.
0x02B	39	Set PA_BIAS3 output to approximately -1.1 V in transmit mode.
0x02C	39	Set PA_BIAS4 output to approximately -1.1 V in transmit mode.
0x02D	00	Set LNA_BIAS to approximately 0 V, while in receive mode.
0x030	1F	Enable LNA_BIAS, select fixed output.
0x038	60	Select SPI instead of internal RAM for channel settings.
0x031	1C	Select TR input for transmit and receive switching control, enables switch outputs.
0x02F	7F	Select all four transmit channel and enable transmit driver, vector modulator, and VGA.
0x036	16	Set transmit VGA bias to 2, vector modulator bias to 6.
0x037	06	Set transmit driver bias to 6.
0x01C	FF	Set Channel 1 attenuator to 0 dB, VGA gain to maximum.
0x020	36	Set Channel 1 vector modulator I input to positive, Magnitude 16.
0x021	35	Set Channel 1 vector modulator Q input to positive, Magnitude 15. These two together set phase to 45°.
0x01D	FF	Set Channel 2 attenuator to 0 dB, VGA gain to maximum.
0x022	36	Set Channel 2 vector modulator I input to positive, Magnitude 16.
0x023	35	Set Channel 2 vector modulator Q input to positive, Magnitude 15. These two together set phase to 45°.
0x01E	FF	Set Channel 3 attenuator to 0 dB, VGA gain to maximum.
0x024	36	Set Channel 3 vector modulator I input to positive, Magnitude 16.
0x025	35	Set Channel 3 vector modulator Q input to positive, Magnitude 15. These two together set phase to 45°.
0x01F	FF	Set Channel 4 attenuator to 0 dB, VGA gain to maximum.
0x026	36	Set Channel 4 vector modulator I input to positive, Magnitude 16.
0x027	35	Set Channel 4 vector modulator Q input to positive, Magnitude 15. These two together set phase to 45°.
0x02E	7F	Select all four receive channel, enable receive LNA, vector modulator and VGA.
0x034	08	Set receive LNA bias to 8.
0x035	16	Set receive VGA bias to 2, vector modulator bias to 6.
0x010	FF	Set Channel 1 attenuator to 0 dB, VGA gain to maximum.
0x014	36	Set Channel 1 vector modulator I input to positive, Magnitude 16.
0x015	35	Set Channel 1 vector modulator Q input to positive, Magnitude 15. These two together set phase to 45°.
0x011	FF	Set Channel 2 attenuator to 0 dB, VGA gain to maximum.
0x016	36	Set Channel 2 vector modulator I input to positive, Magnitude 16.
0x017	35	Set Channel 2 vector modulator Q input to positive, Magnitude 15. These two together set phase to 45°.
0x012	FF	Set Channel 3 attenuator to 0 dB; VGA gain to maximum.
0x018	36	Set Channel 3 vector modulator I input to positive, Magnitude 16.
0x019	35	Set Channel 3 vector modulator Q input to positive, Magnitude 15. These two together set phase to 45°.
0x013	FF	Set Channel 4 attenuator to 0 dB, VGA gain to maximum.

APPLICATIONS INFORMATION

Table 30. Register Programming to Set Up the ADAR1000

Register Address	Content (Hexadecimal)	Description
0x01A	36	Set Channel 4 vector modulator I input to positive, Magnitude 16.
0x01B	35	Set Channel 4 vector modulator Q input to positive, Magnitude 15. These two together set phase to 45°.

Table 31. ADAR1000 Memory Register Programming Example for Beam Position 0 and Bias Setting 1

Register ¹	Content	Description
0x038	00	Set beam ram bypass and bias ram bypass bits to load working registers from memory
0x1000	FF	Set receiver VGA gain and attenuator values for Channel 1; VGA gain maximum, attenuator = 0 dB
0x1001	36	Set receiver I vector and polarity values for Channel 1; positive polarity, Magnitude = 16
0x1002	35	Set receiver Q vector and polarity values for Channel 1; positive polarity, Magnitude = 15
0x1004	FF	Set receiver VGA gain and attenuator values for Channel 2; VGA gain maximum, attenuator = 0 dB
0x1005	36	Set receiver I vector and polarity values for Channel 2; positive polarity, Magnitude = 16
0x1006	35	Set receiver Q vector and polarity values for Channel 2; positive polarity, Magnitude = 15
0x1008	FF	Set receiver VGA gain and attenuator values for Channel 3; VGA gain maximum, attenuator = 0 dB
0x1009	36	Set receiver I vector and polarity values for Channel 3; positive polarity, Magnitude = 16
0x100A	35	Set receiver Q vector and polarity values for Channel 3; positive polarity, Magnitude = 15
0x100C	FF	Set receiver VGA gain and attenuator values for Channel 4; VGA gain maximum, attenuator = 0 dB
0x100D	36	Set receiver I vector and polarity values for Channel 4; positive polarity, Magnitude = 16
0x100E	35	Set receiver Q vector and polarity values for Channel 4; positive polarity, Magnitude = 15
0x1790	60	Set receiver EXT_LNA_BIAS_OFF value for receiver Bias Setting 1; -1.8 V output
0x1791	28	Set receiver EXT_LNA_BIAS_ON value for receiver Bias Setting 1; -0.8 V output
0x1794	16	Set receiver vector modulator and VGA bias values for receiver; VGA = 2, vector modulator = 6
0x1795	08	Set receiver LNA bias value for receiver; LNA = 8
0x1800	FF	Set transmitter VGA gain and attenuator values for Channel 1
0x1801	36	Set transmitter I vector and polarity values for Channel 1
0x1802	35	Set transmitter Q vector and polarity values for Channel 1
0x1804	FF	Set transmitter VGA gain and attenuator values for Channel 2
0x1805	36	Set transmitter I vector and polarity values for Channel 2
0x1806	35	Set transmitter Q vector and polarity values for Channel 2
0x1808	FF	Set transmitter VGA gain and attenuator values for Channel 3
0x1809	36	Set transmitter I vector and polarity values for Channel 3
0x180A	35	Set transmitter Q vector and polarity values for Channel 3
0x180C	FF	Set transmitter VGA gain and attenuator values for Channel 4
0x180D	36	Set transmitter I vector and polarity values for Channel 4
0x180E	35	Set transmitter Q vector and polarity values for Channel 4
0x1F90	60	Set transmitter EXT_PA1_BIAS_OFF value for transmitter; -1.8 V output
0x1F91	60	Set transmitter EXT_PA2_BIAS_OFF value for transmitter; -1.8 V output
0x1F92	60	Set transmitter EXT_PA3_BIAS_OFF value for transmitter; -1.8 V output
0x1F94	28	Set transmitter EXT_PA1_BIAS_ON value for transmitter; -0.8 V output
0x1F95	28	Set transmitter EXT_PA2_BIAS_ON value for transmitter; -0.8 V output
0x1F96	28	Set transmitter EXT_PA3_BIAS_ON value for transmitter; -0.8 V output
0x1F98	60	Set transmitter EXT_PA4_BIAS_OFF value for transmitter; -1.8 V output
0x1F99	28	Set transmitter EXT_PA4_BIAS_ON value for transmitter; -0.8 V output
0x1F9C	16	Set transmitter vector modulator and VGA bias values for transmitter; VGA bias = 2, vector modulator = 6
0x1F9D	06	Set transmitter driver bias value for transmitter; driver = 6
0x39	80	Set all receiver channels to Beam Position 0 and set the fetch bit; the user can individually set the receiver channels using Register 0x03D through Register 0x040
0x3A	80	Set all transmitter channels to Beam Position 0 and set the fetch bit; the user can individually set the transmitter channels using Register 0x041 through Register 0x044

APPLICATIONS INFORMATION**Table 31. ADAR1000 Memory Register Programming Example for Beam Position 0 and Bias Setting 1**

Register ¹	Content	Description
0x51	08	Set receiver bias to Bias Setting 1 and set the fetch bit
0x52	08	Set receiver bias to Bias Setting 1 and set the fetch bit

¹ Transmitter and receiver gain are set to maximum and the phase value is 45° for all channels.

REGISTER MAP

Table 32. Control Registers Summary

Reg. (Hex)	Name	Bits	Bit 7	Bit 6	Bit 5	Bit 4	Bit 3	Bit 2	Bit 1	Bit 0	Reset	R/W
000	INTERFACE_CONFIG_A	[7:0]	SOFTRESET	LSB_FIRST	ADDR_ASCN	SDOACTIVE	SDOACTIVE	ADDR_ASCN	LSB_FIRST	SOFT_RESET	0x00	R/W
001	INTERFACE_CONFIG_B	[7:0]	SINGLE_INSTRUCTION	CSB_STALL	MASTER_SLAVE_RB	SLOW_INTERFACE_CTRL	RESERVED	SOFT_RESET		RESERVED	0x00	R/W
003	CHIP_TYPE	[7:0]	CHIP_TYPE								0x00	R
004	PRODUCT_ID_H	[7:0]	PRODUCT_ID[15:8]								0x00	R
005	PRODUCT_ID_L	[7:0]	PRODUCT_ID[7:0]								0x00	R
00A	SCRATCH_PAD	[7:0]	SCRATCHPAD								0x00	R/W
00B	SPI_REV	[7:0]	SPI_REV								0x00	R
00C	VENDOR_ID_H	[7:0]	VENDOR_ID[15:8]								0x00	R
00D	VENDOR_ID_L	[7:0]	VENDOR_ID[7:0]								0x00	R
00F	TRANSFER_REG	[7:0]	RESERVED							MASTER_SLAVE_XFER	0x00	R/W
010	CH1_RX_GAIN	[7:0]	CH1_ATTN_RX				RX_VGA_CH1			0x00	R/W	
011	CH2_RX_GAIN	[7:0]	CH2_ATTN_RX				RX_VGA_CH2			0x00	R/W	
012	CH3_RX_GAIN	[7:0]	CH3_ATTN_RX				RX_VGA_CH3			0x00	R/W	
013	CH4_RX_GAIN	[7:0]	CH4_ATTN_RX				RX_VGA_CH4			0x00	R/W	
014	CH1_RX_PHASE_I	[7:0]	RESERVED		RX_VM_CH1_POL_I	RX_VM_CH1_GAIN_I				0x00	R/W	
015	CH1_RX_PHASE_Q	[7:0]	RESERVED		RX_VM_CH1_POL_Q	RX_VM_CH1_GAIN_Q				0x00	R/W	
016	CH2_RX_PHASE_I	[7:0]	RESERVED		RX_VM_CH2_POL_I	RX_VM_CH2_GAIN_I				0x00	R/W	
017	CH2_RX_PHASE_Q	[7:0]	RESERVED		RX_VM_CH2_POL_Q	RX_VM_CH2_GAIN_Q				0x00	R/W	
018	CH3_RX_PHASE_I	[7:0]	RESERVED		RX_VM_CH3_POL_I	RX_VM_CH3_GAIN_I				0x00	R/W	
019	CH3_RX_PHASE_Q	[7:0]	RESERVED		RX_VM_CH3_POL_Q	RX_VM_CH3_GAIN_Q				0x00	R/W	
01A	CH4_RX_PHASE_I	[7:0]	RESERVED		RX_VM_CH4_POL_I	RX_VM_CH4_GAIN_I				0x00	R/W	
01B	CH4_RX_PHASE_Q	[7:0]	RESERVED		RX_VM_CH4_POL_Q	RX_VM_CH4_GAIN_Q				0x00	R/W	

REGISTER MAP

Table 32. Control Registers Summary

Reg. (Hex)	Name	Bits	Bit 7	Bit 6	Bit 5	Bit 4	Bit 3	Bit 2	Bit 1	Bit 0	Reset	R/W	
					CH4_POL_Q								
01C	CH1_TX_GAIN	[7:0]	CH1_ATTN_TX								TX_VGA_CH1	0x00	R/W
01D	CH2_TX_GAIN	[7:0]	CH2_ATTN_TX								TX_VGA_CH2	0x00	R/W
01E	CH3_TX_GAIN	[7:0]	CH3_ATTN_TX								TX_VGA_CH3	0x00	R/W
01F	CH4_TX_GAIN	[7:0]	CH4_ATTN_TX								TX_VGA_CH4	0x00	R/W
020	CH1_TX_PHASE_I	[7:0]	RESERVED		TX_VM_						TX_VM_CH1_GAIN_I	0x00	R/W
					CH1_POL_I								
021	CH1_TX_PHASE_Q	[7:0]	RESERVED		TX_VM_						TX_VM_CH1_GAIN_Q	0x00	R/W
					CH1_POL_Q								
022	CH2_TX_PHASE_I	[7:0]	RESERVED		TX_VM_						TX_VM_CH2_GAIN_I	0x00	R/W
					CH2_POL_I								
023	CH2_TX_PHASE_Q	[7:0]	RESERVED		TX_VM_						TX_VM_CH2_GAIN_Q	0x00	R/W
					CH2_POL_Q								
024	CH3_TX_PHASE_I	[7:0]	RESERVED		TX_VM_						TX_VM_CH3_GAIN_I	0x00	R/W
					CH3_POL_I								
025	CH3_TX_PHASE_Q	[7:0]	RESERVED		TX_VM_						TX_VM_CH3_GAIN_Q	0x00	R/W
					CH3_POL_Q								
026	CH4_TX_PHASE_I	[7:0]	RESERVED		TX_VM_						TX_VM_CH4_GAIN_I	0x00	R/W
					CH4_POL_I								
027	CH4_TX_PHASE_Q	[7:0]	RESERVED		TX_VM_						TX_VM_CH4_GAIN_Q	0x00	R/W
					CH4_POL_Q								
028	LD_WRK_REGS	[7:0]	RESERVED						LDTX_OVERRIDE	LDRX_OVERRIDE		0x00	W
029	CH1_PA_BIAS_ON	[7:0]									EXT_PA1_BIAS_ON	0x00	R/W
02A	CH2_PA_BIAS_ON	[7:0]									EXT_PA2_BIAS_ON	0x00	R/W
02B	CH3_PA_BIAS_ON	[7:0]									EXT_PA3_BIAS_ON	0x00	R/W
02C	CH4_PA_BIAS_ON	[7:0]									EXT_PA4_BIAS_ON	0x00	R/W
02D	LNA_BIAS_ON	[7:0]									EXT_LNA_BIAS_ON	0x00	R/W
02E	RX_ENABLES	[7:0]	RESERVED	CH1_	CH2_	CH3_	CH4_	RX_	RX_		RX_VGA_EN	0x00	R/W

REGISTER MAP

Table 32. Control Registers Summary

Reg. (Hex)	Name	Bits	Bit 7	Bit 6	Bit 5	Bit 4	Bit 3	Bit 2	Bit 1	Bit 0	Reset	R/W	
02F	TX_ENABLES	[7:0]	RESERVED	RX_EN TX_EN	RX_EN TX_EN	RX_EN TX_EN	RX_EN TX_EN	LNA_EN DRV_EN	VM_EN VM_EN	TX_VGA_EN	0x00	R/W	
030	MISC_ENABLES	[7:0]	SW_DRV_ TR_MODE_SEL	BIAS_ CTRL	BIAS_EN	LNA_ BIAS_ OUT_EN	CH1_ DET_EN	CH2_ DET_EN	CH3_ DET_EN	CH4_ DET_EN	0x00	R/W	
031	SW_CTRL	[7:0]	SW_DRV_ TR_STATE	TX_EN	RX_EN	SW_DRV_ EN_TR	SW_DRV_ EN_POL	TR_ SOURCE	TR_SPI	POL	0x00	R/W	
032	ADC_CTRL	[7:0]	ADC_ CLKFREQ_SEL	ADC_ EN	CLK_EN	ST_CONV		MUX_SEL		ADC_EOC	0x00	R/W	
033	ADC_OUTPUT	[7:0]	ADC									0x00	R
034	BIAS_CURRENT_ RX_LNA	[7:0]	RESERVED				LNA_BIAS				0x00	R/W	
035	BIAS_CURRENT_ RX	[7:0]	RESERVED	RX_VGA_BIAS				RX_VM_BIAS			0x00	R/W	
036	BIAS_CURRENT_ TX	[7:0]	RESERVED	TX_VGA_BIAS				TX_VM_BIAS			0x00	R/W	
037	BIAS_CURRENT_ TX_DRV	[7:0]	RESERVED				TX_DRV_BIAS				0x00	R/W	
038	MEM_CTRL	[7:0]	SCAN_ MODE_EN	BEAM_ RAM_ BYPASS	BIAS_ RAM_ BYPASS	RESERVED	TX_BEAM_ STEP_EN	RX_ BEAM_ STEP_ EN	TX_CHX_ RAM_ BYPASS	RX_CHX_ RAM_ BYPASS	0x00	R/W	
039	RX_CHX_MEM	[7:0]	RX_CHX_ RAM_FETCH	RX_CHX_RAM_INDEX							0x00	R/W	
03A	TX_CHX_MEM	[7:0]	TX_CHX_ RAM_FETCH	TX_CHX_RAM_INDEX							0x00	R/W	
03D	RX_CH1_MEM	[7:0]	RX_CH1_ RAM_FETCH	RX_CH1_RAM_INDEX							0x00	R/W	
03E	RX_CH2_MEM	[7:0]	RX_CH2_RAM_ FETCH	RX_CH2_RAM_INDEX							0x00	R/W	
03F	RX_CH3_MEM	[7:0]	RX_CH3_RAM_ FETCH	RX_CH3_RAM_INDEX							0x00	R/W	
040	RX_CH4_MEM	[7:0]	RX_CH4_ RAM_FETCH	RX_CH4_RAM_INDEX							0x00	R/W	
041	TX_CH1_MEM	[7:0]	TX_CH1_ RAM_FETCH	TX_CH1_RAM_INDEX							0x00	R/W	
042	TX_CH2_MEM	[7:0]	TX_CH2_ RAM_FETCH	TX_CH2_RAM_INDEX							0x00	R/W	
043	TX_CH3_MEM	[7:0]	TX_CH3_ RAM_FETCH	TX_CH3_RAM_INDEX							0x00	R/W	
044	TX_CH4_MEM	[7:0]	TX_CH4_ RAM_FETCH	TX_CH4_RAM_INDEX							0x00	R/W	
045	REV_ID	[7:0]	REV_ID									0x00	R
046	CH1_PA_BIAS_ OFF	[7:0]	EXT_PA1_BIAS_OFF									0x00	R/W
047	CH2_PA_BIAS_ OFF	[7:0]	EXT_PA2_BIAS_OFF									0x00	R/W

REGISTER MAP

Table 32. Control Registers Summary

Reg. (Hex)	Name	Bits	Bit 7	Bit 6	Bit 5	Bit 4	Bit 3	Bit 2	Bit 1	Bit 0	Reset	R/W
	OFF											
048	CH3_PA_BIAS_OFF	[7:0]					EXT_PA3_BIAS_OFF				0x00	R/W
049	CH4_PA_BIAS_OFF	[7:0]					EXT_PA4_BIAS_OFF				0x00	R/W
04A	LNA_BIAS_OFF	[7:0]					EXT_LNA_BIAS_OFF				0x00	R/W
04B	TX_TO_RX_DELAY_CTRL	[7:0]			TX_TO_RX_DELAY_1			TX_TO_RX_DELAY_2			0x00	R/W
04C	RX_TO_TX_DELAY_CTRL	[7:0]			RX_TO_TX_DELAY_1			RX_TO_TX_DELAY_2			0x00	R/W
04D	TX_BEAM_STEP_START	[7:0]					TX_BEAM_STEP_START				0x00	R/W
04E	TX_BEAM_STEP_STOP	[7:0]					TX_BEAM_STEP_STOP				0x00	R/W
04F	RX_BEAM_STEP_START	[7:0]					RX_BEAM_STEP_START				0x00	R/W
050	RX_BEAM_STEP_STOP	[7:0]					RX_BEAM_STEP_STOP				0x00	R/W
051	RX_BIAS_RAM_CTL	[7:0]			RESERVED		RX_BIAS_RAM_FETC_H		RX_BIAS_RAM_INDEX		0x00	R/W
052	TX_BIAS_RAM_CTL	[7:0]			RESERVED		TX_BIAS_RAM_FETC_H		TX_BIAS_RAM_INDEX		0x00	R/W
400	LDO_TRIM_CTL_0	[7:0]				LDO_TRIM_REG_2P8V				LDO_TRIM_REG_1P8V	0x00	R/W
401	LDO_TRIM_CTL_1	[7:0]				RESERVED				LDO_TRIM_SEL	0x00	R/W

REGISTER MAP

REGISTER DESCRIPTIONS

Address: 0x000, Reset: 0x00, Name: INTERFACE_CONFIG_A

Register 0x00 has special functionality not applicable to any other register. This special functionality for soft reset is:

- ▶ When issuing a soft reset to Chip 0, all chips on the SPI bus perform a soft reset.
- ▶ When issuing a soft reset to any chip other than Chip 0, no chips on the SPI bus reset.

There is not a way to soft reset an individual chip only. For the remaining bits in Register 0x00, the functionality is as follows:

- ▶ When asserting LSB first, address ascension, or the SDO active bit on Chip 0, all chips on the SPI bus are set to LSB first mode, address ascension mode, or SDO enabled, respectively.
- ▶ When asserting LSB first, Address ascension, or the SDO active bit on Chip x (x = 1, 2, or 3), only Chip x is set to LSB first mode, address ascension mode, or SDO enabled, respectively.

Note that the data bits are a palindrome: the functions of the last four bits in this register are intentionally replicated from the first four bits in a reverse manner so that the bit pattern is the same, whether sent LSB first or MSB first.

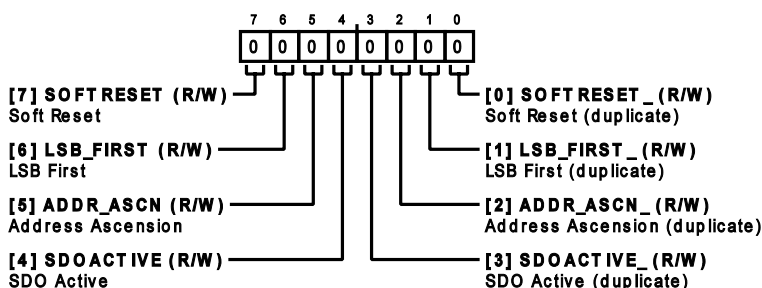
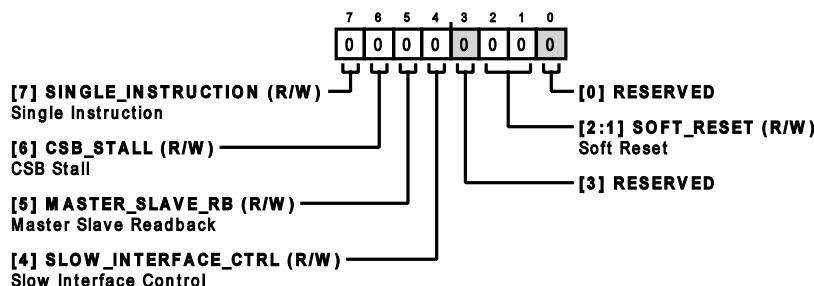

Table 33. Bit Descriptions for INTERFACE_CONFIG_A

Bit	Bit Name	Settings	Description	Reset	Access
7	SOFTRESET		Soft Reset	0x0	R/W
6	LSB_FIRST		LSB First	0x0	R/W
5	ADDR_ASCN		Address Ascension	0x0	R/W
4	SDOACTIVE		SDO Active	0x0	R/W
3	SDOACTIVE_		SDO Active (duplicate)	0x0	R/W
2	ADDR_ASCN_		Address Ascension (duplicate)	0x0	R/W
1	LSB_FIRST_		LSB First (duplicate)	0x0	R/W
0	SOFTRESET_		Soft Reset (duplicate)	0x0	R/W

Address: 0x001, Reset: 0x00, Name: INTERFACE_CONFIG_B



REGISTER MAP

Table 34. Bit Descriptions for INTERFACE_CONFIG_B

Bit(s)	Bit Name	Settings	Description	Reset	Access
7	SINGLE_INSTRUCTION		Single Instruction	0x0	R/W
6	CSB_STALL		CSB Stall	0x0	R/W
5	MASTER_SLAVE_RB		Master Slave Readback	0x0	R/W
4	SLOW_INTERFACE_CTRL		Slow Interface Control	0x0	R/W
3	RESERVED		Reserved	0x0	R
[2:1]	SOFT_RESET		Soft Reset	0x0	R/W
0	RESERVED		Reserved	0x0	R

Address: 0x003, Reset: 0x00, Name: CHIP_TYPE

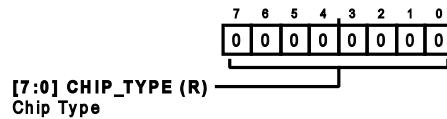

Table 35. Bit Descriptions for CHIP_TYPE

Bit(s)	Bit Name	Settings	Description	Reset	Access
[7:0]	CHIP_TYPE		Chip Type	0x0	R

Address: 0x004, Reset: 0x00, Name: PRODUCT_ID_H

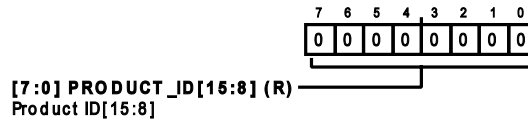

Table 36. Bit Descriptions for PRODUCT_ID_H

Bit(s)	Bit Name	Settings	Description	Reset	Access
[7:0]	PRODUCT_ID[15:8]		Product ID[15:8]	0x0	R

Address: 0x005, Reset: 0x00, Name: PRODUCT_ID_L

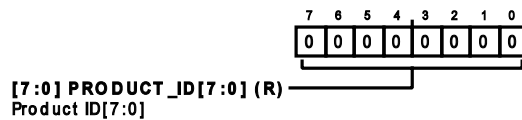
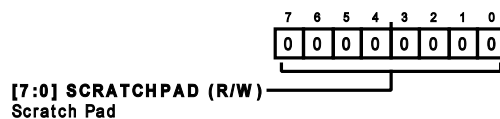

Table 37. Bit Descriptions for PRODUCT_ID_L

Bit(s)	Bit Name	Settings	Description	Reset	Access
[7:0]	PRODUCT_ID[7:0]		Product ID[7:0]	0x0	R

Address: 0x00A, Reset: 0x00, Name: SCRATCH_PAD



REGISTER MAP

Table 38. Bit Descriptions for SCRATCH_PAD

Bit(s)	Bit Name	Settings	Description	Reset	Access
[7:0]	SCRATCHPAD		Scratch Pad	0x0	R/W

Address: 0x00B, Reset: 0x00, Name: SPI_REV

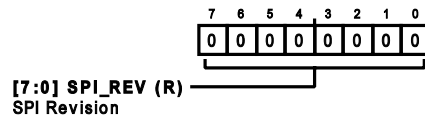

Table 39. Bit Descriptions for SPI_REV

Bit(s)	Bit Name	Settings	Description	Reset	Access
[7:0]	SPI_REV		SPI Revision	0x0	R

Address: 0x00C, Reset: 0x00, Name: VENDOR_ID_H

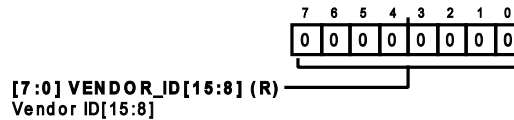

Table 40. Bit Descriptions for VENDOR_ID_H

Bit(s)	Bit Name	Settings	Description	Reset	Access
[7:0]	VENDOR_ID[15:8]		Vendor ID[15:8]	0x0	R

Address: 0x00D, Reset: 0x00, Name: VENDOR_ID_L

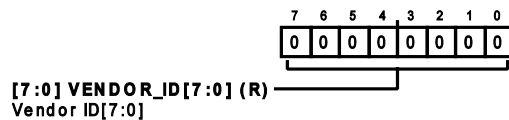

Table 41. Bit Descriptions for VENDOR_ID_L

Bit(s)	Bit Name	Settings	Description	Reset	Access
[7:0]	VENDOR_ID[7:0]		Vendor ID[7:0]	0x0	R

Address: 0x00F, Reset: 0x00, Name: TRANSFER_REG

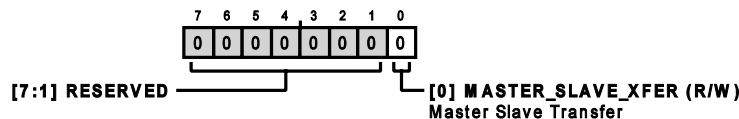

Table 42. Bit Descriptions for TRANSFER_REG

Bit(s)	Bit Name	Settings	Description	Reset	Access
[7:1]	RESERVED		Reserved	0x0	R
0	MASTER_SLAVE_XFER		Master Slave Transfer	0x0	R/W

Address: 0x010, Reset: 0x00, Name: CH1_RX_GAIN

REGISTER MAP

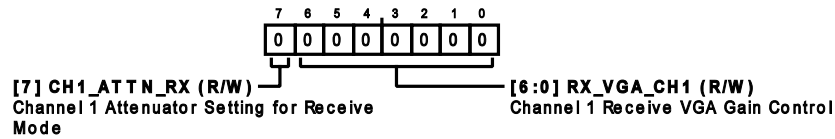

Table 43. Bit Descriptions for CH1_RX_GAIN

Bit(s)	Bit Name	Settings	Description	Reset	Access
7	CH1_ATT_N_RX		Channel 1 Attenuator Setting for Receive Mode. Assert high for attenuator bypass.	0x0	R/W
[6:0]	RX_VGA_CH1		Channel 1 Receive VGA Gain Control	0x0	R/W

Address: 0x011, Reset: 0x00, Name: CH2_RX_GAIN

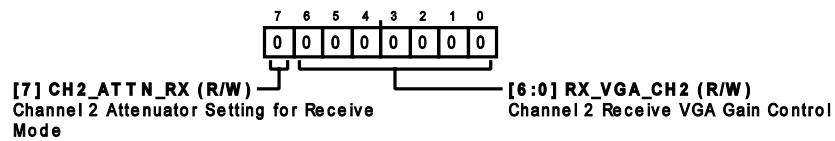

Table 44. Bit Descriptions for CH2_RX_GAIN

Bit(s)	Bit Name	Settings	Description	Reset	Access
7	CH2_ATT_N_RX		Channel 2 Attenuator Setting for Receive Mode. Assert high for attenuator bypass.	0x0	R/W
[6:0]	RX_VGA_CH2		Channel 2 Receive VGA Gain Control	0x0	R/W

Address: 0x012, Reset: 0x00, Name: CH3_RX_GAIN

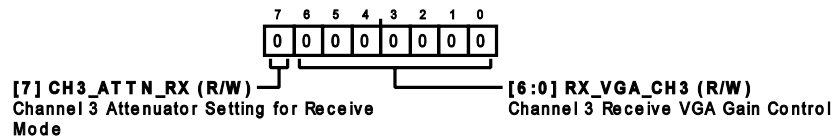

Table 45. Bit Descriptions for CH3_RX_GAIN

Bit(s)	Bit Name	Settings	Description	Reset	Access
7	CH3_ATT_N_RX		Channel 3 Attenuator Setting for Receive Mode. Assert high for attenuator bypass.	0x0	R/W
[6:0]	RX_VGA_CH3		Channel 3 Receive VGA Gain Control	0x0	R/W

Address: 0x013, Reset: 0x00, Name: CH4_RX_GAIN

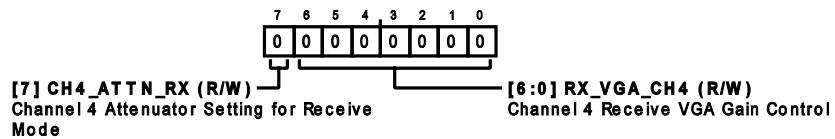

Table 46. Bit Descriptions for CH4_RX_GAIN

Bit(s)	Bit Name	Settings	Description	Reset	Access
7	CH4_ATT_N_RX		Channel 4 Attenuator Setting for Receive Mode. Assert high for attenuator bypass.	0x0	R/W
[6:0]	RX_VGA_CH4		Channel 4 Receive VGA Gain Control	0x0	R/W

REGISTER MAP

Address: 0x014, Reset: 0x00, Name: CH1_RX_PHASE_I

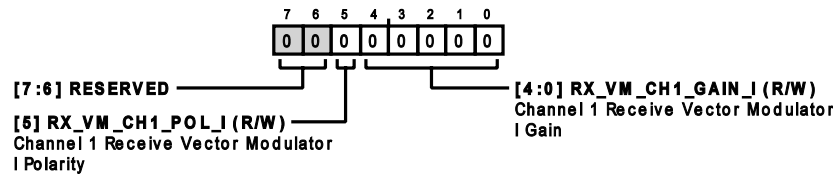

Table 47. Bit Descriptions for CH1_RX_PHASE_I

Bit(s)	Bit Name	Settings	Description	Reset	Access
[7:6]	RESERVED		Reserved	0x0	R
5	RX_VM_CH1_POL_I		Channel 1 Receive Vector Modulator I Polarity	0x0	R/W
[4:0]	RX_VM_CH1_GAIN_I		Channel 1 Receive Vector Modulator I Gain	0x0	R/W

Address: 0x015, Reset: 0x00, Name: CH1_RX_PHASE_Q

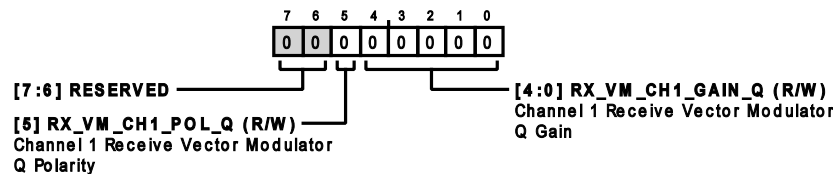

Table 48. Bit Descriptions for CH1_RX_PHASE_Q

Bit(s)	Bit Name	Settings	Description	Reset	Access
[7:6]	RESERVED		Reserved	0x0	R
5	RX_VM_CH1_POL_Q		Channel 1 Receive Vector Modulator Q Polarity	0x0	R/W
[4:0]	RX_VM_CH1_GAIN_Q		Channel 1 Receive Vector Modulator Q Gain	0x0	R/W

Address: 0x016, Reset: 0x00, Name: CH2_RX_PHASE_I

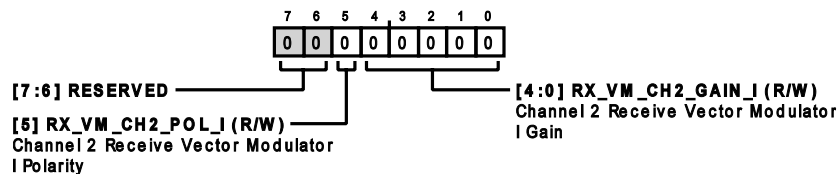
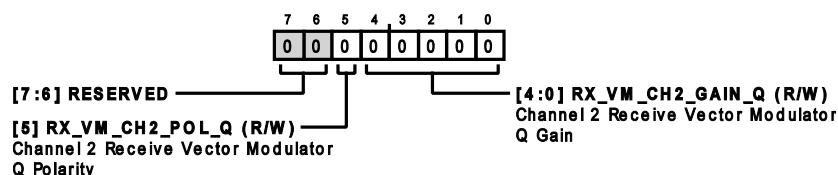

Table 49. Bit Descriptions for CH2_RX_PHASE_I

Bit(s)	Bit Name	Settings	Description	Reset	Access
[7:6]	RESERVED		Reserved	0x0	R
5	RX_VM_CH2_POL_I		Channel 2 Receive Vector Modulator I Polarity	0x0	R/W
[4:0]	RX_VM_CH2_GAIN_I		Channel 2 Receive Vector Modulator I Gain	0x0	R/W

Address: 0x017, Reset: 0x00, Name: CH2_RX_PHASE_Q



REGISTER MAP

Table 50. Bit Descriptions for CH2_RX_PHASE_Q

Bit(s)	Bit Name	Settings	Description	Reset	Access
[7:6]	RESERVED		Reserved	0x0	R
5	RX_VM_CH2_POL_Q		Channel 2 Receive Vector Modulator Q Polarity	0x0	R/W
[4:0]	RX_VM_CH2_GAIN_Q		Channel 2 Receive Vector Modulator Q Gain	0x0	R/W

Address: 0x018, Reset: 0x00, Name: CH3_RX_PHASE_I

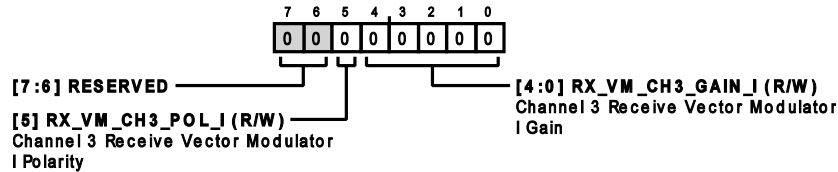

Table 51. Bit Descriptions for CH3_RX_PHASE_I

Bit(s)	Bit Name	Settings	Description	Reset	Access
[7:6]	RESERVED		Reserved.	0x0	R
5	RX_VM_CH3_POL_I		Channel 3 Receive Vector Modulator I Polarity	0x0	R/W
[4:0]	RX_VM_CH3_GAIN_I		Channel 3 Receive Vector Modulator I Gain	0x0	R/W

Address: 0x019, Reset: 0x00, Name: CH3_RX_PHASE_Q

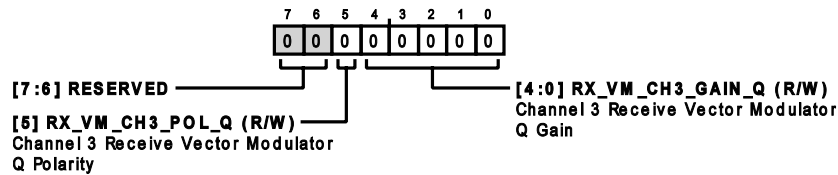

Table 52. Bit Descriptions for CH3_RX_PHASE_Q

Bit(s)	Bit Name	Settings	Description	Reset	Access
[7:6]	RESERVED		Reserved	0x0	R
5	RX_VM_CH3_POL_Q		Channel 3 Receive Vector Modulator Q Polarity	0x0	R/W
[4:0]	RX_VM_CH3_GAIN_Q		Channel 3 Receive Vector Modulator Q Gain	0x0	R/W

Address: 0x01A, Reset: 0x00, Name: CH4_RX_PHASE_I

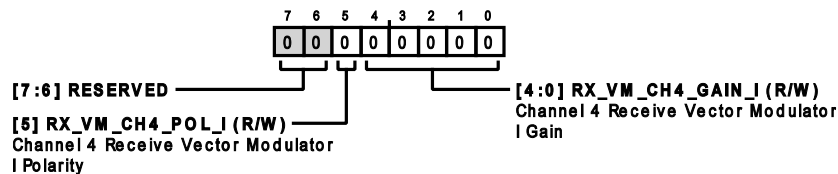

Table 53. Bit Descriptions for CH4_RX_PHASE_I

Bit(s)	Bit Name	Settings	Description	Reset	Access
[7:6]	RESERVED		Reserved	0x0	R
5	RX_VM_CH4_POL_I		Channel 4 Receive Vector Modulator I Polarity	0x0	R/W
[4:0]	RX_VM_CH4_GAIN_I		Channel 4 Receive Vector Modulator I Gain	0x0	R/W

Address: 0x01B, Reset: 0x00, Name: CH4_RX_PHASE_Q

REGISTER MAP

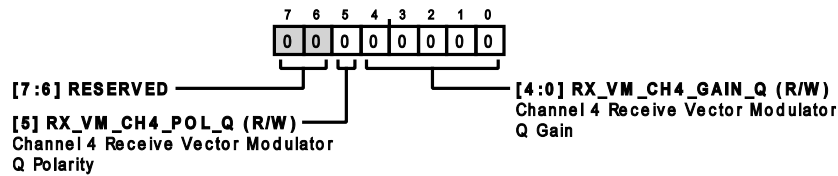

Table 54. Bit Descriptions for CH4_RX_PHASE_Q

Bit(s)	Bit Name	Settings	Description	Reset	Access
[7:6]	RESERVED		Reserved	0x0	R
5	RX_VM_CH4_POL_Q		Channel 4 Receive Vector Modulator Q Polarity	0x0	R/W
[4:0]	RX_VM_CH4_GAIN_Q		Channel 4 Receive Vector Modulator Q Gain	0x0	R/W

Address: 0x01C, Reset: 0x00, Name: CH1_TX_GAIN

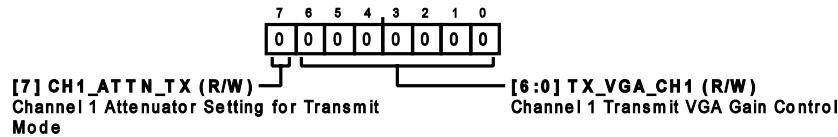

Table 55. Bit Descriptions for CH1_TX_GAIN

Bit(s)	Bit Name	Settings	Description	Reset	Access
7	CH1_ATT_N_TX		Channel 1 Attenuator Setting for Transmit Mode. Assert high for attenuator bypass.	0x0	R/W
[6:0]	TX_VGA_CH1		Channel 1 Transmit VGA Gain Control	0x0	R/W

Address: 0x01D, Reset: 0x00, Name: CH2_TX_GAIN

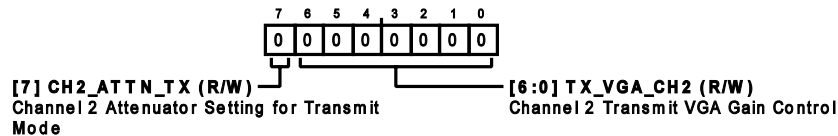

Table 56. Bit Descriptions for CH2_TX_GAIN

Bit(s)	Bit Name	Settings	Description	Reset	Access
7	CH2_ATT_N_TX		Channel 2 Attenuator Setting for Transmit Mode. Assert high for attenuator bypass.	0x0	R/W
[6:0]	TX_VGA_CH2		Channel 2 Transmit VGA Gain Control	0x0	R/W

Address: 0x01E, Reset: 0x00, Name: CH3_TX_GAIN

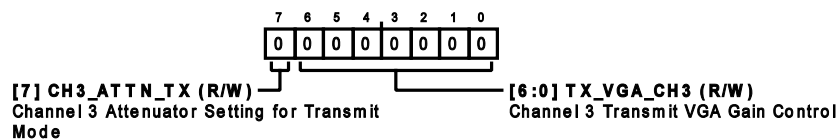

Table 57. Bit Descriptions for CH3_TX_GAIN

Bit(s)	Bit Name	Settings	Description	Reset	Access
7	CH3_ATT_N_TX		Channel 3 Attenuator Setting for Transmit Mode. Assert high for attenuator bypass.	0x0	R/W
[6:0]	TX_VGA_CH3		Channel 3 Transmit VGA Gain Control	0x0	R/W

Address: 0x01F, Reset: 0x00, Name: CH4_TX_GAIN

REGISTER MAP

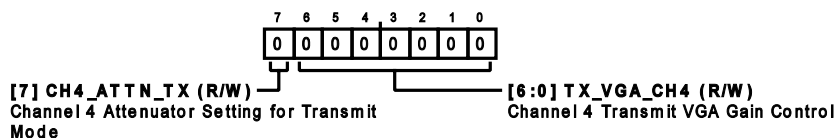

Table 58. Bit Descriptions for CH4_TX_GAIN

Bit(s)	Bit Name	Settings	Description	Reset	Access
7	CH4_ATTN_TX		Channel 4 Attenuator Setting for Transmit Mode. Assert high for attenuator bypass.	0x0	R/W
[6:0]	TX_VGA_CH4		Channel 4 Transmit VGA Gain Control	0x0	R/W

Address: 0x020, Reset: 0x00, Name: CH1_TX_PHASE_I

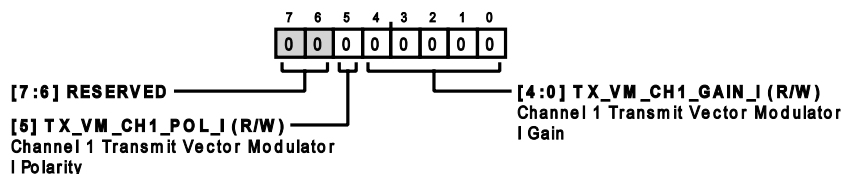

Table 59. Bit Descriptions for CH1_TX_PHASE_I

Bit(s)	Bit Name	Settings	Description	Reset	Access
[7:6]	RESERVED		Reserved	0x0	R
5	TX_VM_CH1_POL_I		Channel 1 Transmit Vector Modulator I Polarity	0x0	R/W
[4:0]	TX_VM_CH1_GAIN_I		Channel 1 Transmit Vector Modulator I Gain	0x0	R/W

Address: 0x021, Reset: 0x00, Name: CH1_TX_PHASE_Q

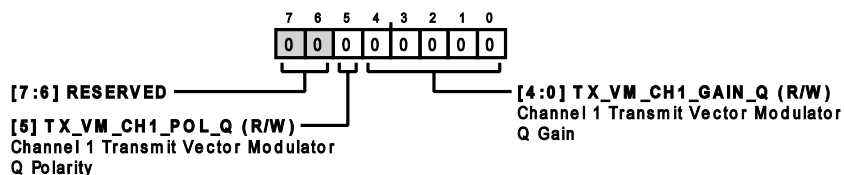
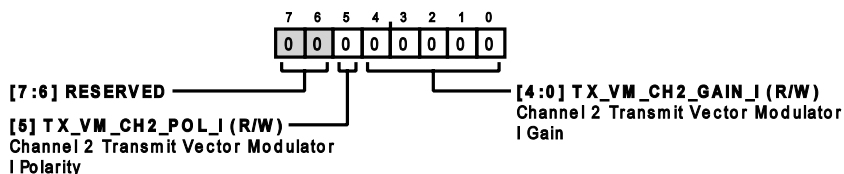

Table 60. Bit Descriptions for CH1_TX_PHASE_Q

Bit(s)	Bit Name	Settings	Description	Reset	Access
[7:6]	RESERVED		Reserved	0x0	R
5	TX_VM_CH1_POL_Q		Channel 1 Transmit Vector Modulator Q Polarity	0x0	R/W
[4:0]	TX_VM_CH1_GAIN_Q		Channel 1 Transmit Vector Modulator Q Gain	0x0	R/W

Address: 0x022, Reset: 0x00, Name: CH2_TX_PHASE_I



REGISTER MAP

Table 61. Bit Descriptions for CH2_TX_PHASE_I

Bit(s)	Bit Name	Settings	Description	Reset	Access
[7:6]	RESERVED		Reserved	0x0	R
5	TX_VM_CH2_POL_I		Channel 2 Transmit Vector Modulator I Polarity	0x0	R/W
[4:0]	TX_VM_CH2_GAIN_I		Channel 2 Transmit Vector Modulator I Gain	0x0	R/W

Address: 0x023, Reset: 0x00, Name: CH2_TX_PHASE_Q

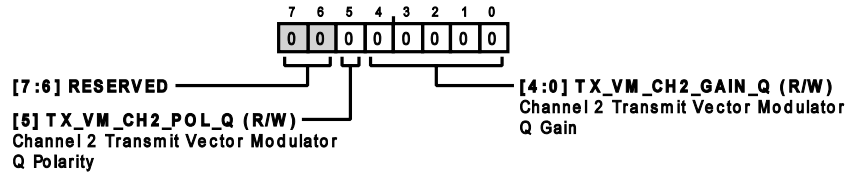

Table 62. Bit Descriptions for CH2_TX_PHASE_Q

Bit(s)	Bit Name	Settings	Description	Reset	Access
[7:6]	RESERVED		Reserved	0x0	R
5	TX_VM_CH2_POL_Q		Channel 2 Transmit Vector Modulator Q Polarity	0x0	R/W
[4:0]	TX_VM_CH2_GAIN_Q		Channel 2 Transmit Vector Modulator Q Gain	0x0	R/W

Address: 0x024, Reset: 0x00, Name: CH3_TX_PHASE_I

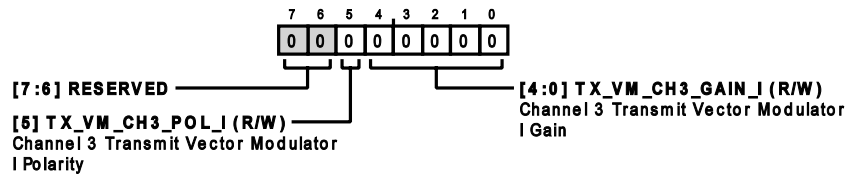

Table 63. Bit Descriptions for CH3_TX_PHASE_I

Bit(s)	Bit Name	Settings	Description	Reset	Access
[7:6]	RESERVED		Reserved	0x0	R
5	TX_VM_CH3_POL_I		Channel 3 Transmit Vector Modulator I Polarity	0x0	R/W
[4:0]	TX_VM_CH3_GAIN_I		Channel 3 Transmit Vector Modulator I Gain	0x0	R/W

Address: 0x025, Reset: 0x00, Name: CH3_TX_PHASE_Q

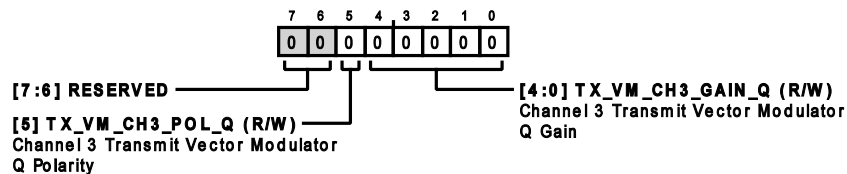

Table 64. Bit Descriptions for CH3_TX_PHASE_Q

Bit(s)	Bit Name	Settings	Description	Reset	Access
[7:6]	RESERVED		Reserved	0x0	R
5	TX_VM_CH3_POL_Q		Channel 3 Transmit Vector Modulator Q Polarity	0x0	R/W
[4:0]	TX_VM_CH3_GAIN_Q		Channel 3 Transmit Vector Modulator Q Gain	0x0	R/W

Address: 0x026, Reset: 0x00, Name: CH4_TX_PHASE_I

REGISTER MAP

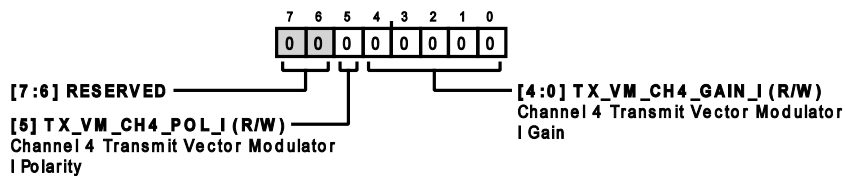

Table 65. Bit Descriptions for CH4_TX_PHASE_I

Bit(s)	Bit Name	Settings	Description	Reset	Access
[7:6]	RESERVED		Reserved	0x0	R
5	TX_VM_CH4_POL_I		Channel 4 Transmit Vector Modulator I Polarity	0x0	R/W
[4:0]	TX_VM_CH4_GAIN_I		Channel 4 Transmit Vector Modulator I Gain	0x0	R/W

Address: 0x027, Reset: 0x00, Name: CH4_TX_PHASE_Q

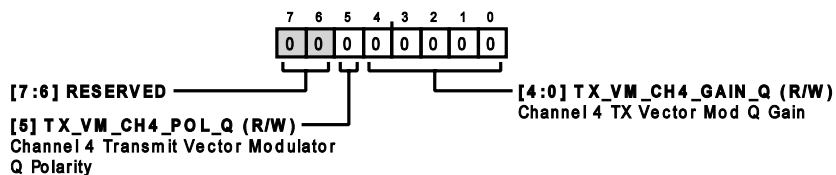

Table 66. Bit Descriptions for CH4_TX_PHASE_Q

Bit(s)	Bit Name	Settings	Description	Reset	Access
[7:6]	RESERVED		Reserved	0x0	R
5	TX_VM_CH4_POL_Q		Channel 4 Transmit Vector Modulator Q Polarity	0x0	R/W
[4:0]	TX_VM_CH4_GAIN_Q		Channel 4 Transmit Vector Modulator Q Gain	0x0	R/W

Address: 0x028, Reset: 0x00, Name: LD_WRK_REGS

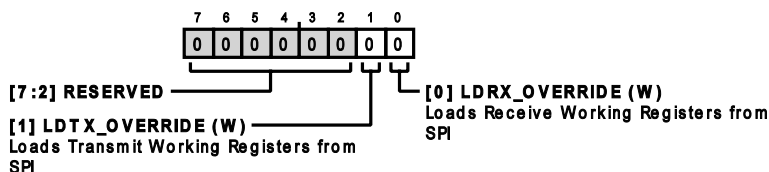
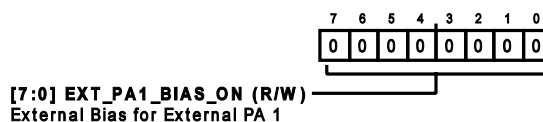

Table 67. Bit Descriptions for LD_WRK_REGS

Bit(s)	Bit Name	Settings	Description	Reset	Access
[7:2]	RESERVED		Reserved	0x0	R
1	LDTX_OVERRIDE		Loads Transmit Working Registers from SPI. Assert high to update transmit gain and phase settings. Also can be used when advancing transmit beam position.	0x0	W
0	LDRX_OVERRIDE		Loads Receive Working Registers from SPI. Assert high to update receive gain and phase settings. Also can be used when advancing receive beam position.	0x0	W

Address: 0x029, Reset: 0x00, Name: CH1_PA_BIAS_ON



REGISTER MAP

Table 68. Bit Descriptions for CH1_PA_BIAS_ON

Bit(s)	Bit Name	Settings	Description	Reset	Access
[7:0]	EXT_PA1_BIAS_ON		External Bias for External PA 1	0x0	R/W

Address: 0x02A, Reset: 0x00, Name: CH2_PA_BIAS_ON

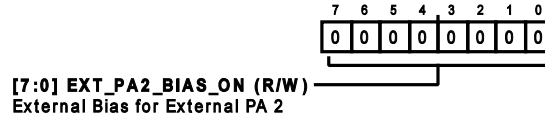

Table 69. Bit Descriptions for CH2_PA_BIAS_ON

Bit(s)	Bit Name	Settings	Description	Reset	Access
[7:0]	EXT_PA2_BIAS_ON		External Bias for External PA 2	0x0	R/W

Address: 0x02B, Reset: 0x00, Name: CH3_PA_BIAS_ON

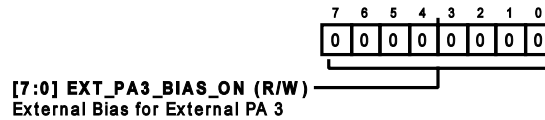

Table 70. Bit Descriptions for CH3_PA_BIAS_ON

Bit(s)	Bit Name	Settings	Description	Reset	Access
[7:0]	EXT_PA3_BIAS_ON		External Bias for External PA 3	0x0	R/W

Address: 0x02C, Reset: 0x00, Name: CH4_PA_BIAS_ON

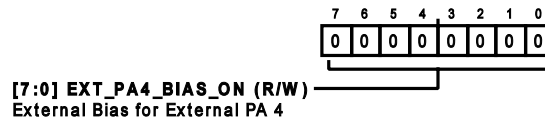

Table 71. Bit Descriptions for CH4_PA_BIAS_ON

Bit(s)	Bit Name	Settings	Description	Reset	Access
[7:0]	EXT_PA4_BIAS_ON		External Bias for External PA 4	0x0	R/W

Address: 0x02D, Reset: 0x00, Name: LNA_BIAS_ON

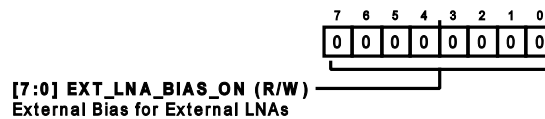

Table 72. Bit Descriptions for LNA_BIAS_ON

Bit(s)	Bit Name	Settings	Description	Reset	Access
[7:0]	EXT_LNA_BIAS_ON		External Bias for External LNAs	0x0	R/W

Address: 0x02E, Reset: 0x00, Name: RX_ENABLES

REGISTER MAP

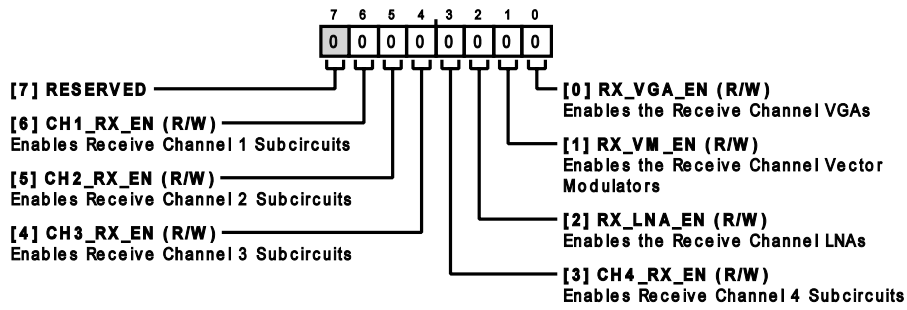

Table 73. Bit Descriptions for RX_ENABLES

Bit	Bit Name	Settings	Description	Reset	Access
7	RESERVED		Reserved	0x0	R
6	CH1_RX_EN		Enables Receive Channel 1 Subcircuits	0x0	R/W
5	CH2_RX_EN		Enables Receive Channel 2 Subcircuits	0x0	R/W
4	CH3_RX_EN		Enables Receive Channel 3 Subcircuits	0x0	R/W
3	CH4_RX_EN		Enables Receive Channel 4 Subcircuits	0x0	R/W
2	RX_LNA_EN		Enables the Receive Channel LNAs	0x0	R/W
1	RX_VM_EN		Enables the Receive Channel Vector Modulators	0x0	R/W
0	RX_VGA_EN		Enables the Receive Channel VGAs	0x0	R/W

Address: 0x02F, Reset: 0x00, Name: TX_ENABLES

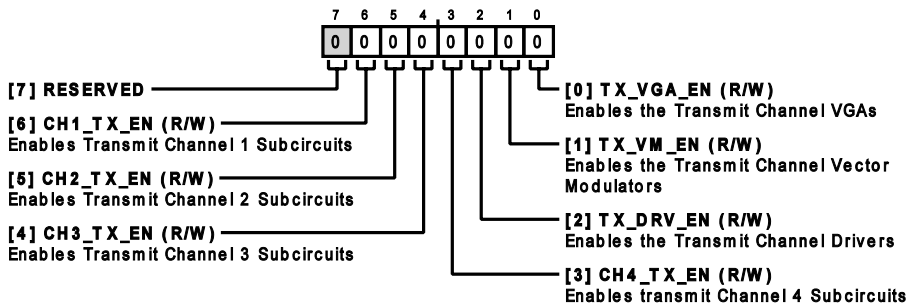

Table 74. Bit Descriptions for TX_ENABLES

Bit	Bit Name	Settings	Description	Reset	Access
7	RESERVED		Reserved	0x0	R
6	CH1_TX_EN		Enables Transmit Channel 1 Subcircuits	0x0	R/W
5	CH2_TX_EN		Enables Transmit Channel 2 Subcircuits	0x0	R/W
4	CH3_TX_EN		Enables Transmit Channel 3 Subcircuits	0x0	R/W
3	CH4_TX_EN		Enables Transmit Channel 4 Subcircuits	0x0	R/W
2	TX_DRV_EN		Enables the Transmit Channel Drivers	0x0	R/W
1	TX_VM_EN		Enables the Transmit Channel Vector Modulators	0x0	R/W
0	TX_VGA_EN		Enables the Transmit Channel VGAs	0x0	R/W

Address: 0x030, Reset: 0x00, Name: MISC_ENABLES

REGISTER MAP

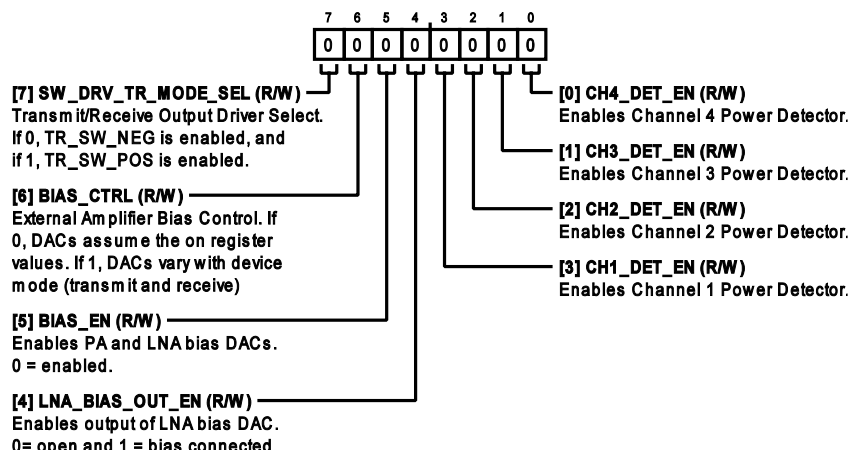

Table 75. Bit Descriptions for MISC_ENABLES

Bit	Bit Name	Settings	Description	Reset	Access
7	SW_DRV_TR_MODE_SEL		Transmit/Receive Output Driver Select. If 0, TR_SW_POS is enabled, and if 1, TR_SW_NEG is enabled.	0x0	R/W
6	BIAS_CTRL		External Amplifier Bias Control. If 0, DACs assume the on register values. If 1, DACs vary with device mode (transmit and receive).	0x0	R/W
5	BIAS_EN		Enables PA and LNA Bias DACs. 0 = enabled.	0x0	R/W
4	LNA_BIAS_OUT_EN		Enables Output of LNA Bias DAC. 0 = open and 1 = bias connected.	0x0	R/W
3	CH1_DET_EN		Enables Channel 1 Power Detector.	0x0	R/W
2	CH2_DET_EN		Enables Channel 2 Power Detector.	0x0	R/W
1	CH3_DET_EN		Enables Channel 3 Power Detector.	0x0	R/W
0	CH4_DET_EN		Enables Channel 4 Power Detector.	0x0	R/W

Address: 0x031, Reset: 0x00, Name: SW_CTRL

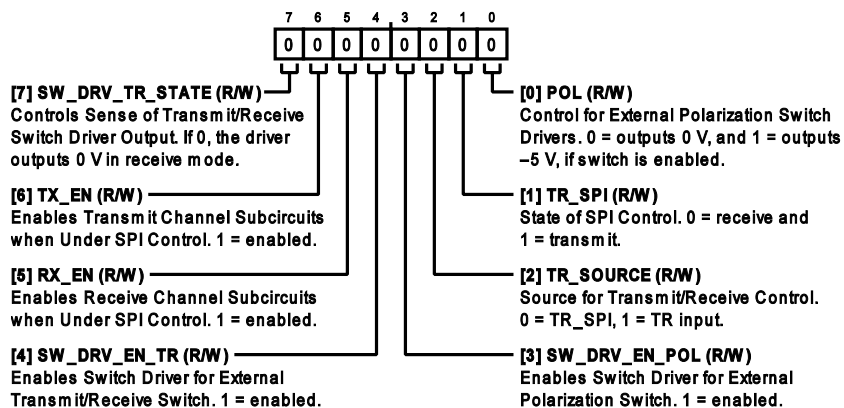

Table 76. Bit Descriptions for SW_CTRL

Bit	Bit Name	Settings	Description	Reset	Access
7	SW_DRV_TR_STATE		Controls Polarity of Transmit/Receive Switch Driver Output. If 0, the driver outputs 0 V in receive mode.	0x0	R/W
6	TX_EN		Enables Transmit Channel Subcircuits when Under SPI Control. 1 = enabled.	0x0	R/W
5	RX_EN		Enables Receive Channel Subcircuits when Under SPI Control. 1 = enabled.	0x0	R/W

REGISTER MAP

Table 76. Bit Descriptions for SW_CTRL

Bit	Bit Name	Settings	Description	Reset	Access
4	SW_DRV_EN_TR		Enables Switch Driver for External Transmit/Receive Switch. 1 = enabled.	0x0	R/W
3	SW_DRV_EN_POL		Enables Switch Driver for External Polarization Switch. 1 = enabled.	0x0	R/W
2	TR_SOURCE		Source for Transmit/Receive Control. 0 = TR_SPI, 1 = TR input.	0x0	R/W
1	TR_SPI		Transmit or Receive mode while in SPI Control. 0 = receive and 1 = transmit.	0x0	R/W
0	POL		Control for External Polarity Switch Drivers. 0 = outputs 0 V, and 1 = outputs -5 V, if switch is enabled.	0x0	R/W

Address: 0x032, Reset: 0x00, Name: ADC_CTRL

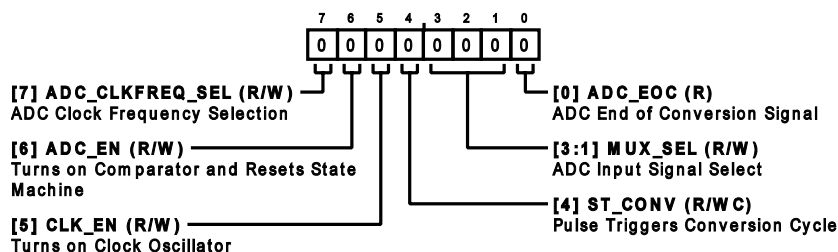

Table 77. Bit Descriptions for ADC_CTRL

Bit(s)	Bit Name	Settings	Description	Reset	Access
7	ADC_CLKFREQ_SEL		ADC Clock Frequency Selection. 0 = 2 MHz, 1 = 250 kHz	0x0	R/W
6	ADC_EN		Turns on ADC and Resets State Machine. 1 = enabled	0x0	R/W
5	CLK_EN		Turns on Clock Oscillator. 1 = enabled	0x0	R/W
4	ST_CONV		Active High Triggers Conversion Cycle. Self-clearing	0x0	R/WC
[3:1]	MUX_SEL	0b000 0b001 0b010 0b011 0b100	ADC Input Signal Select Temperature Sensor Detector 1 Detector 2 Detector 3 Detector 4	0x0	R/W
0	ADC_EOC		ADC End of Conversion Signal. Active high; low during conversion.	0x0	R

Address: 0x033, Reset: 0x00, Name: ADC_OUTPUT

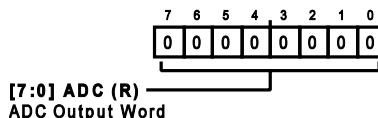
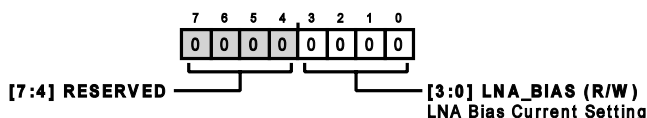

Table 78. Bit Descriptions for ADC_OUTPUT

Bit(s)	Bit Name	Settings	Description	Reset	Access
[7:0]	ADC		ADC Output Word	0x0	R

Address: 0x034, Reset: 0x00, Name: BIAS_CURRENT_RX_LNA



REGISTER MAP

Table 79. Bit Descriptions for BIAS_CURRENT_RX_LNA

Bit(s)	Bit Name	Settings	Description	Reset	Access
[7:4]	RESERVED		Reserved	0x0	R
[3:0]	LNA_BIAS		LNA Bias Current Setting	0x0	R/W

Address: 0x035, Reset: 0x00, Name: BIAS_CURRENT_RX

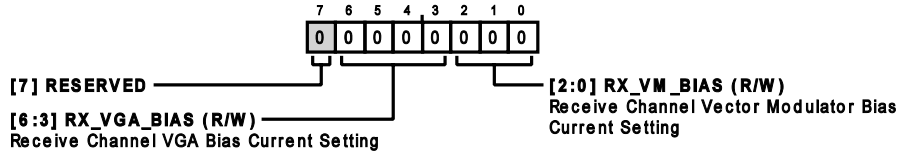

Table 80. Bit Descriptions for BIAS_CURRENT_RX

Bit(s)	Bit Name	Settings	Description	Reset	Access
7	RESERVED		Reserved	0x0	R
[6:3]	RX_VGA_BIAS		Receive Channel VGA Bias Current Setting	0x0	R/W
[2:0]	RX_VM_BIAS		Receive Channel Vector Modulator Bias Current Setting	0x0	R/W

Address: 0x036, Reset: 0x00, Name: BIAS_CURRENT_TX

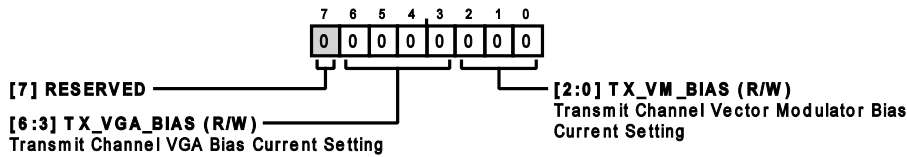

Table 81. Bit Descriptions for BIAS_CURRENT_TX

Bit(s)	Bit Name	Settings	Description	Reset	Access
7	RESERVED		Reserved	0x0	R
[6:3]	TX_VGA_BIAS		Transmit Channel VGA Bias Current Setting	0x0	R/W
[2:0]	TX_VM_BIAS		Transmit Channel Vector Modulator Bias Current Setting	0x0	R/W

Address: 0x037, Reset: 0x00, Name: BIAS_CURRENT_TX_DRV

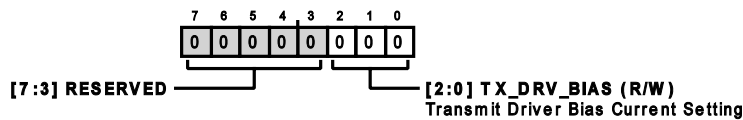

Table 82. Bit Descriptions for BIAS_CURRENT_TX_DRV

Bit(s)	Bit Name	Settings	Description	Reset	Access
[7:3]	RESERVED		Reserved	0x0	R
[2:0]	TX_DRV_BIAS		Transmit Driver Bias Current Setting	0x0	R/W

Address: 0x038, Reset: 0x00, Name: MEM_CTRL

REGISTER MAP

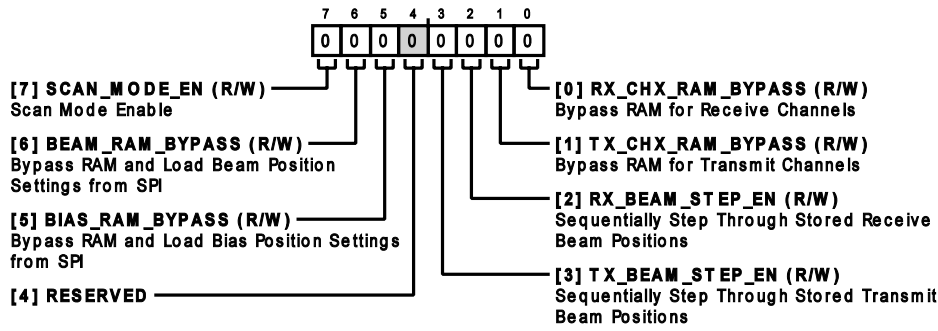

Table 83. Bit Descriptions for MEM_CTRL

Bit	Bit Name	Settings	Description	Reset	Access
7	SCAN_MODE_EN		Scan Mode Enable. SPI test mode enable. For Analog Devices, Inc., internal use only.	0x0	R/W
6	BEAM_RAM_BYPASS		Bypass RAM and Load Beam Position Settings from SPI. 0 = Load Beam Positions from RAM, 1 = Load beam position from registers	0x0	R/W
5	BIAS_RAM_BYPASS		Bypass RAM and Load Bias Position Settings from SPI. 0 = Load Bias Positions from RAM, 1 = Load bias position from registers	0x0	R/W
4	RESERVED		Reserved.	0x0	R
3	TX_BEAM_STEP_EN		Sequentially Step Through Stored Transmit Beam Positions.	0x0	R/W
2	RX_BEAM_STEP_EN		Sequentially Step Through Stored Receive Beam Positions.	0x0	R/W
1	TX_CHX_RAM_BYPASS		Assert high to load different beam position indices for each transmit channel and use Registers 0x41 to 0x44. Else keep low to load the same beam position for all transmit channels and use Register 0x3A. .	0x0	R/W
0	RX_CHX_RAM_BYPASS		Assert high to load different beam position indices for each receive channel and use Registers 0x3D to 0x40. Else keep low to load the same beam position for all receive channels and use Register 0x39.	0x0	R/W

Address: 0x039, Reset: 0x00, Name: RX_CHX_MEM

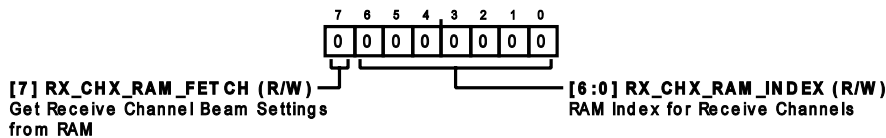
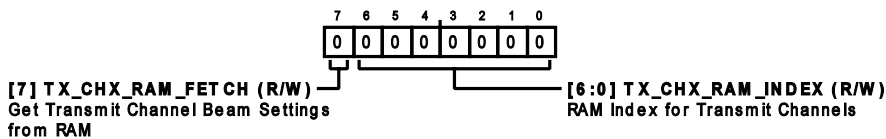

Table 84. Bit Descriptions for RX_CHX_MEM

Bit(s)	Bit Name	Settings	Description	Reset	Access
7	RX_CHX_RAM_FETCH		Get Receive Channel Beam Settings from RAM	0x0	R/W
[6:0]	RX_CHX_RAM_INDEX		RAM Index for Receive Channels	0x0	R/W

Address: 0x03A, Reset: 0x00, Name: TX_CHX_MEM



REGISTER MAP

Table 85. Bit Descriptions for TX_CHX_MEM

Bit(s)	Bit Name	Settings	Description	Reset	Access
7	TX_CHX_RAM_FETCH		Get Transmit Channel Beam Settings from RAM	0x0	R/W
[6:0]	TX_CHX_RAM_INDEX		RAM Index for Transmit Channels	0x0	R/W

Address: 0x03D, Reset: 0x00, Name: RX_CH1_MEM

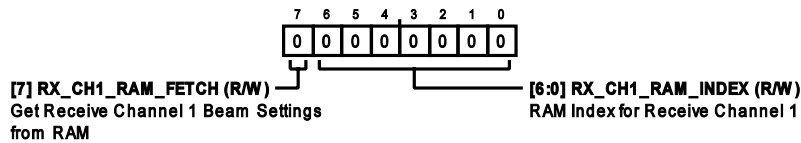

Table 86. Bit Descriptions for RX_CH1_MEM

Bit(s)	Bit Name	Settings	Description	Reset	Access
7	RX_CH1_RAM_FETCH		Get Receive Channel 1 Beam Settings from RAM	0x0	R/W
[6:0]	RX_CH1_RAM_INDEX		RAM Index for Receive Channel 1	0x0	R/W

Address: 0x03E, Reset: 0x00, Name: RX_CH2_MEM

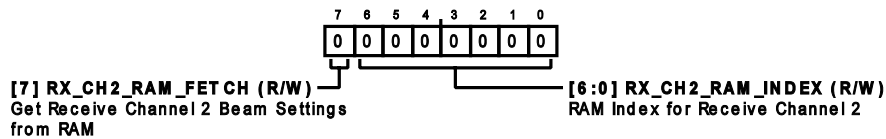

Table 87. Bit Descriptions for RX_CH2_MEM

Bit(s)	Bit Name	Settings	Description	Reset	Access
7	RX_CH2_RAM_FETCH		Get Receive Channel 2 Beam Settings from RAM	0x0	R/W
[6:0]	RX_CH2_RAM_INDEX		RAM Index for Receive Channel 2	0x0	R/W

Address: 0x03F, Reset: 0x00, Name: RX_CH3_MEM

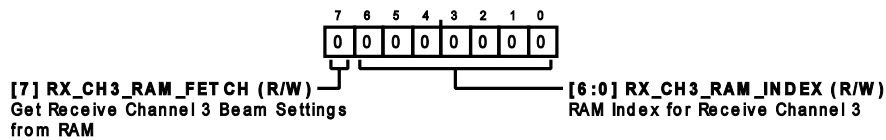
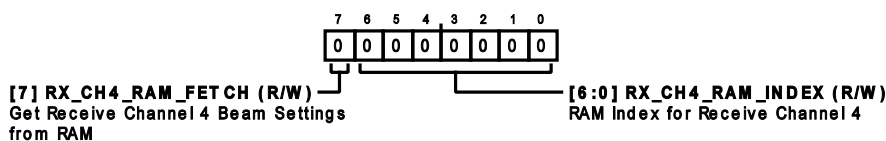

Table 88. Bit Descriptions for RX_CH3_MEM

Bit(s)	Bit Name	Settings	Description	Reset	Access
7	RX_CH3_RAM_FETCH		Get Receive Channel 3 Beam Settings from RAM	0x0	R/W
[6:0]	RX_CH3_RAM_INDEX		RAM Index for Receive Channel 3	0x0	R/W

Address: 0x040, Reset: 0x00, Name: RX_CH4_MEM



REGISTER MAP

Table 89. Bit Descriptions for RX_CH4_MEM

Bit(s)	Bit Name	Settings	Description	Reset	Access
7	RX_CH4_RAM_FETCH		Get Receive Channel 4 Beam Settings from RAM	0x0	R/W
[6:0]	RX_CH4_RAM_INDEX		RAM Index for Receive Channel 4	0x0	R/W

Address: 0x041, Reset: 0x00, Name: TX_CH1_MEM

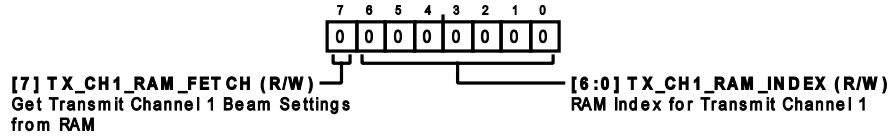

Table 90. Bit Descriptions for TX_CH1_MEM

Bit(s)	Bit Name	Settings	Description	Reset	Access
7	TX_CH1_RAM_FETCH		Get Transmit Channel 1 Beam Settings from RAM	0x0	R/W
[6:0]	TX_CH1_RAM_INDEX		RAM Index for Transmit Channel 1	0x0	R/W

Address: 0x042, Reset: 0x00, Name: TX_CH2_MEM

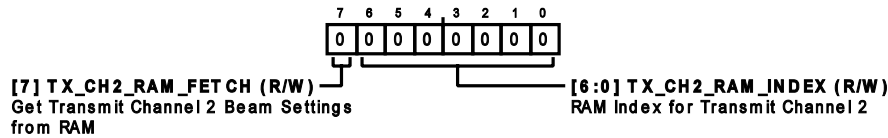

Table 91. Bit Descriptions for TX_CH2_MEM

Bit(s)	Bit Name	Settings	Description	Reset	Access
7	TX_CH2_RAM_FETCH		Get Transmit Channel 2 Beam Settings from RAM	0x0	R/W
[6:0]	TX_CH2_RAM_INDEX		RAM Index for Transmit Channel 2	0x0	R/W

Address: 0x043, Reset: 0x00, Name: TX_CH3_MEM

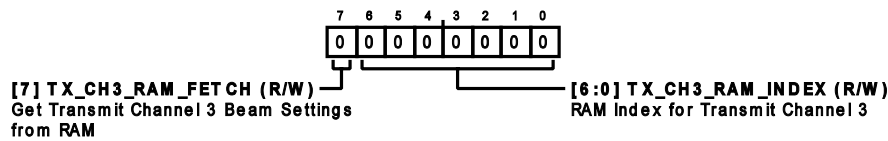
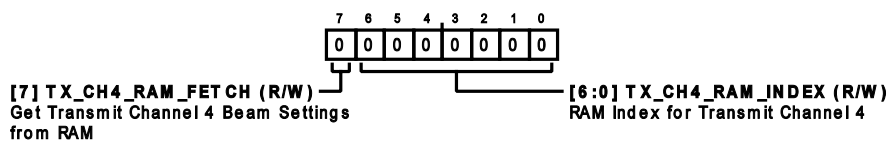

Table 92. Bit Descriptions for TX_CH3_MEM

Bit(s)	Bit Name	Settings	Description	Reset	Access
7	TX_CH3_RAM_FETCH		Get Transmit Channel 3 Beam Settings from RAM	0x0	R/W
[6:0]	TX_CH3_RAM_INDEX		RAM Index for Transmit Channel 3	0x0	R/W

Address: 0x044, Reset: 0x00, Name: TX_CH4_MEM



REGISTER MAP

Table 93. Bit Descriptions for TX_CH4_MEM

Bit(s)	Bit Name	Settings	Description	Reset	Access
7	TX_CH4_RAM_FETCH		Get Transmit Channel 4 Beam Settings from RAM	0x0	R/W
[6:0]	TX_CH4_RAM_INDEX		RAM Index for Transmit Channel 4	0x0	R/W

Address: 0x045, Reset: 0x00, Name: REV_ID

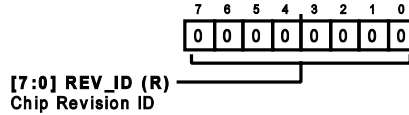

Table 94. Bit Descriptions for REV_ID

Bit(s)	Bit Name	Settings	Description	Reset	Access
[7:0]	REV_ID		Chip Revision ID	0x0	R

Address: 0x046, Reset: 0x00, Name: CH1_PA_BIAS_OFF

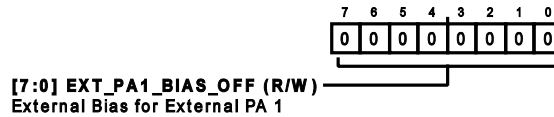

Table 95. Bit Descriptions for CH1_PA_BIAS_OFF

Bit(s)	Bit Name	Settings	Description	Reset	Access
[7:0]	EXT_PA1_BIAS_OFF		External Bias for External PA 1	0x0	R/W

Address: 0x047, Reset: 0x00, Name: CH2_PA_BIAS_OFF

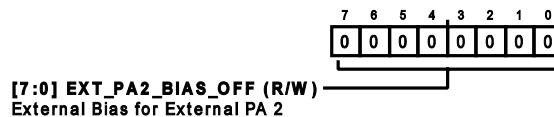

Table 96. Bit Descriptions for CH2_PA_BIAS_OFF

Bit(s)	Bit Name	Settings	Description	Reset	Access
[7:0]	EXT_PA2_BIAS_OFF		External Bias for External PA 2	0x0	R/W

Address: 0x048, Reset: 0x00, Name: CH3_PA_BIAS_OFF

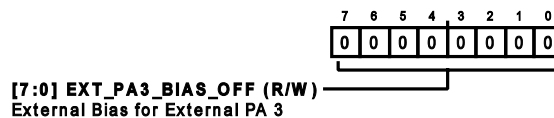

Table 97. Bit Descriptions for CH3_PA_BIAS_OFF

Bit(s)	Bit Name	Settings	Description	Reset	Access
[7:0]	EXT_PA3_BIAS_OFF		External Bias for External PA 3	0x0	R/W

Address: 0x049, Reset: 0x00, Name: CH4_PA_BIAS_OFF

REGISTER MAP

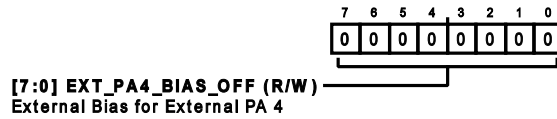

Table 98. Bit Descriptions for CH4_PA_BIAS_OFF

Bit(s)	Bit Name	Settings	Description	Reset	Access
[7:0]	EXT_PA4_BIAS_OFF		External Bias for External PA 4	0x0	R/W

Address: 0x04A, Reset: 0x00, Name: LNA_BIAS_OFF

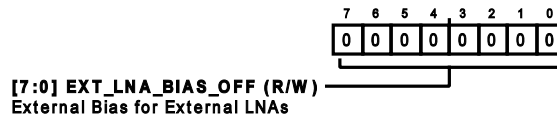

Table 99. Bit Descriptions for LNA_BIAS_OFF

Bit(s)	Bit Name	Settings	Description	Reset	Access
[7:0]	EXT_LNA_BIAS_OFF		External Bias for External LNAs	0x0	R/W

Address: 0x04B, Reset: 0x00, Name: TX_TO_RX_DELAY_CTRL

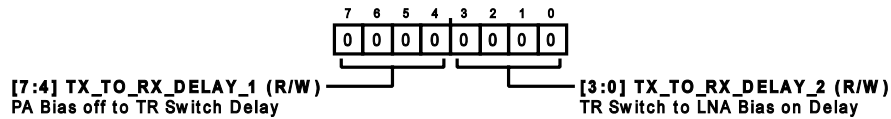

Table 100. Bit Descriptions for TX_TO_RX_DELAY_CTRL

Bit(s)	Bit Name	Settings	Description	Reset	Access
[7:4]	TX_TO_RX_DELAY_1		PA Bias off to TR Switch Delay	0x0	R/W
[3:0]	TX_TO_RX_DELAY_2		TR Switch to LNA Bias on Delay	0x0	R/W

Address: 0x04C, Reset: 0x00, Name: RX_TO_TX_DELAY_CTRL

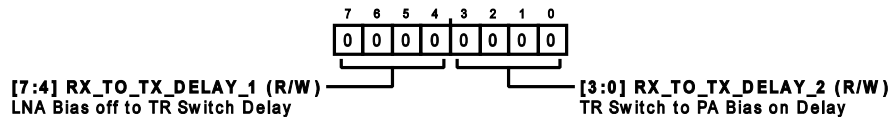

Table 101. Bit Descriptions for RX_TO_TX_DELAY_CTRL

Bit(s)	Bit Name	Settings	Description	Reset	Access
[7:4]	RX_TO_TX_DELAY_1		LNA Bias off to TR Switch Delay	0x0	R/W
[3:0]	RX_TO_TX_DELAY_2		TR Switch to PA Bias on Delay	0x0	R/W

Address: 0x04D, Reset: 0x00, Name: TX_BEAM_STEP_START



REGISTER MAP

Table 102. Bit Descriptions for TX_BEAM_STEP_START

Bit(s)	Bit Name	Settings	Description	Reset	Access
[7:0]	TX_BEAM_STEP_START		Start Memory Address for Transmit Channel Beam Stepping	0x0	R/W

Address: 0x04E, Reset: 0x00, Name: TX_BEAM_STEP_STOP



Table 103. Bit Descriptions for TX_BEAM_STEP_STOP

Bit(s)	Bit Name	Settings	Description	Reset	Access
[7:0]	TX_BEAM_STEP_STOP		Stop Memory Address for Transmit Channel Beam Stepping	0x0	R/W

Address: 0x04F, Reset: 0x00, Name: RX_BEAM_STEP_START



Table 104. Bit Descriptions for RX_BEAM_STEP_START

Bit(s)	Bit Name	Settings	Description	Reset	Access
[7:0]	RX_BEAM_STEP_START		Start Memory Address for Receive Channel Beam Stepping	0x0	R/W

Address: 0x050, Reset: 0x00, Name: RX_BEAM_STEP_STOP

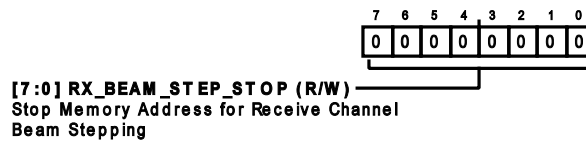

Table 105. Bit Descriptions for RX_BEAM_STEP_STOP

Bit(s)	Bit Name	Settings	Description	Reset	Access
[7:0]	RX_BEAM_STEP_STOP		Stop Memory Address for Receive Channel Beam Stepping	0x0	R/W

Address: 0x051, Reset: 0x00, Name: RX_BIAS_RAM_CTL

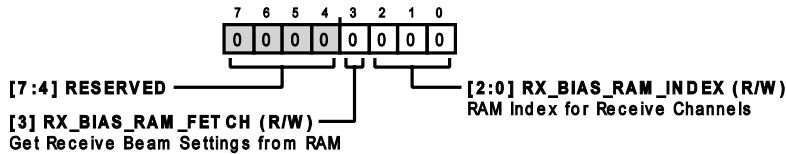

Table 106. Bit Descriptions for RX_BIAS_RAM_CTL

Bit(s)	Bit Name	Settings	Description	Reset	Access
[7:4]	RESERVED		Reserved	0x0	R
3	RX_BIAS_RAM_FETCH		Get Receive Beam Settings from RAM	0x0	R/W

REGISTER MAP

Table 106. Bit Descriptions for RX_BIAS_RAM_CTL

Bit(s)	Bit Name	Settings	Description	Reset	Access
[2:0]	RX_BIAS_RAM_INDEX		RAM Index for Receive Channels	0x0	R/W

Address: 0x052, Reset: 0x00, Name: TX_BIAS_RAM_CTL

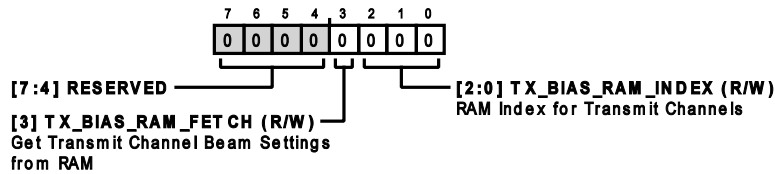

Table 107. Bit Descriptions for TX_BIAS_RAM_CTL

Bit(s)	Bit Name	Settings	Description	Reset	Access
[7:4]	RESERVED		Reserved	0x0	R
3	TX_BIAS_RAM_FETCH		Get Transmit Channel Beam Settings from RAM	0x0	R/W
[2:0]	TX_BIAS_RAM_INDEX		RAM Index for Transmit Channels	0x0	R/W

Address: 0x400, Reset: 0x00, Name: LDO_TRIM_CTL_0

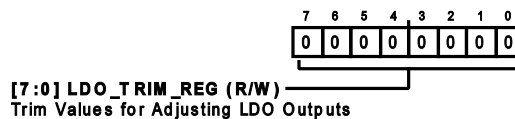

Table 108. Bit Descriptions for LDO_TRIM_CTL_0

Bits	Bit Name	Settings	Description	Reset	Access
[7:4]	LDO_TRIM_REG_2P8V		Trim Values for Adjusting 2.8 V LDO Outputs, Slope = 15 mV/LSB	0x0	R/W
[3:0]	LDO_TRIM_REG_1P8V		Trim Values for Adjusting 1.8 V LDO Outputs, Slope = 10 mV/LSB	0x0	R/W

Address: 0x401, Reset: 0x00, Name: LDO_TRIM_CTL_1

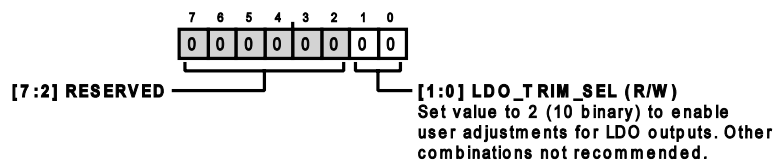

Table 109. Bit Descriptions for LDO_TRIM_CTL_1

Bits	Bit Name	Settings	Description	Reset	Access
[7:2]	RESERVED		Reserved.	0x0	R
[1:0]	LDO_TRIM_SEL		Set value to 2 (10 binary) to enable user adjustments for LDO outputs. Other combinations not recommended.	0x0	R/W

OUTLINE DIMENSIONS

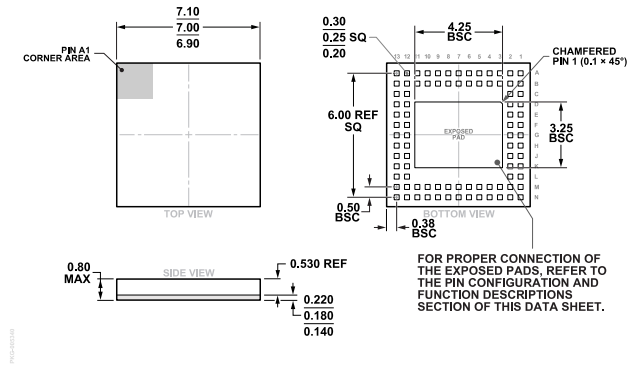

Figure 107. 88-Terminal Land Grid Array [LGA]
(CC-88-1)
Dimensions shown in millimeters

Updated: February 16, 2022

ORDERING GUIDE

Model ¹	Temperature Range	Package Description	Packing Quantity	Package Option
ADAR1000ACCZN	-40°C to +85°C	88-Lead LGA (7mm x 7mm)		CC-88-1
ADAR1000ACCZN-R7	-40°C to +85°C	88-Lead LGA (7mm x 7mm)	Reel, 500	CC-88-1

¹ Z = RoHS Compliant Part.

EVALUATION BOARDS

Model ¹	Description
ADAR1000-EVALZ	Evaluation Board

¹ Z = RoHS Compliant Part.