

PART  
NAME

POTTING BOX

PART  
No.

PB-1554-BF

REV.  
DATE

1-25-11

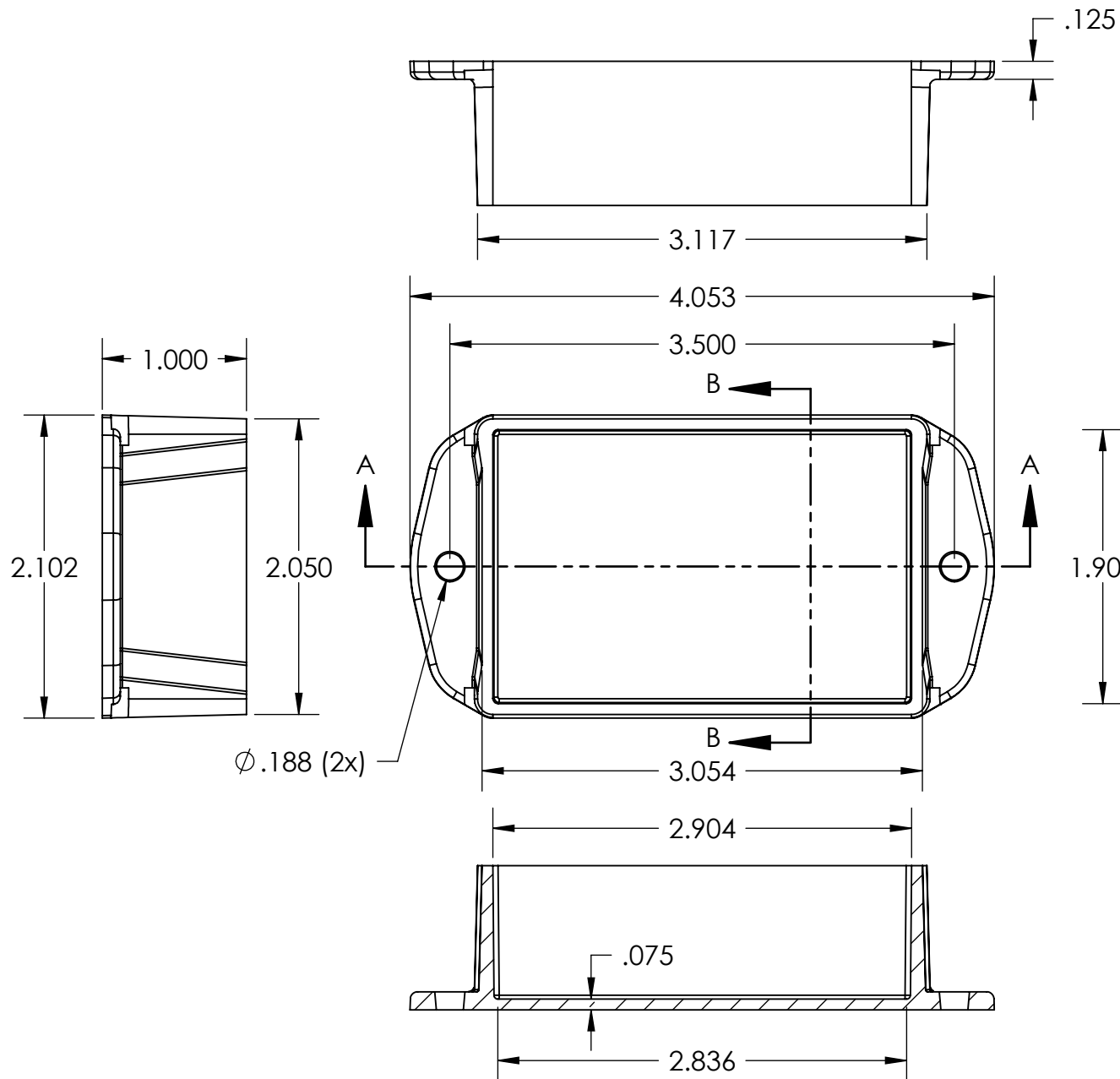

MATERIAL: ABS UL94V-0  
COLOR: BLACK  
FINISHED: TEXTURED OUTSIDE

INSIDE DRAFT:  $.5^\circ \pm .5^\circ$   
OUTSIDE DRAFT:  $1.5^\circ \pm .5^\circ$

ALL DIMENSIONS TOLERANCE:  $\pm .015$

SHIPPED IN PACKAGES OF TEN (10)

SECTION B-B

SECTION A-A

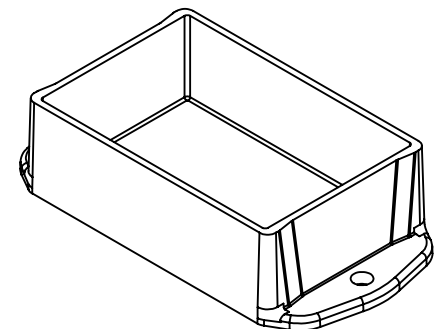

OPTIONAL COVER PART NO.: PBC-1559-C  
(COVER REDUCES INSIDE CLEAR HEIGHT BY .055")