

REVISIONS					
REV	ECO	DESCRIPTION	DATE	BY	APPR
A1	--	RELEASE NEW DRAWING	19/AUG/20	IAN	TOMMY

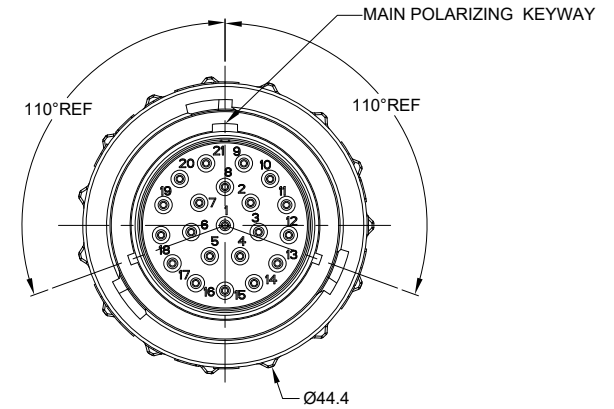

NOTES: UNLESS OTHERWISE SPECIFIED

1. MATERIAL:
HOUSING: THERMOPLASTIC; BLACK
SEAL: SILICONE RUBBER
2. MODIFICATIONS: SMOOTH RING ADAPTER;
STANDARD DIA. WIRE SEAL;
3. SPECIFICATIONS:
3.1 OPERATING TEMPERATURE: -55°C TO +125°C.
3.2 DIELECTRIC WITHSTANDING VOLTAGE: LESS THAN 2 MILLIAMPS CURRENT LEAKAGE @ 1500 VOLTS AC.
3.3 INSULATION RESISTANCE: 1000 MEGOHM MIN @ 25°C.
3.4 MOISTURE RESISTANCE: IP67&IP69K (MATED CONDITION).
3.5 MATING CYCLE DURABILITY: 100 CYCLES
3.6 RoHS COMPLIANT
4. MATING PART: AHDP04-18-21S* (* = SEAL TYPE)
5. ALL DIMENSIONS ARE FOR REFERENCE USE ONLY.

△ CONTACT SIZE AND WIRE RANGE:

CONTACT SIZE	MIN. INSUL O.D.	MAX. INSUL O.D.	TYPICAL WIRE RANGE	CURRENT RATING
20	1.02 mm (.040 in)	2.41 mm (.095 in)	16-22 AWG (1.5-0.5mm ²)	7.5 AMPS

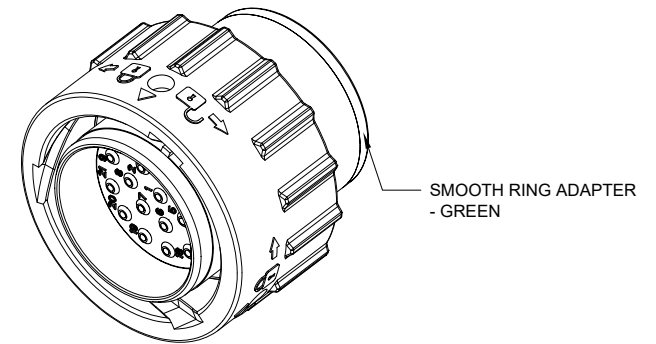

AHDP06-18-21PN-SRA		REF:HDP26-18-21PN	
PART NUMBER		DESCRIPTION	
QUANTITY	MATERIALS LIST		
UNLESS OTHERWISE SPECIFIED: 1) All dimensions are in metric(mm). 2) Tolerances are as follows: 1 PL DEC ±0.30 2 PL DEC ±0.15 3 PL DEC ±0.08 3) Note reference = △ Fractions ±1/64 Angles ±1°		SIGNATURES	DATE
DRAWN: IAN XIAO		19/AUG/20	
CHECKED: ORION LI		20/AUG/20	
APPROVAL: TOMMY XIE		21/AUG/20	
MATERIAL SPECIFICATIONS:		CUSTOMER:	
PROCESS SPECIFICATIONS:		THIS DRAWING IS SUPPLIED FOR INFORMATION ONLY. DESIGN FEATURES, SPECIFICATIONS AND PERFORMANCE DATA SHOWN HEREON ARE THE PROPERTY OF THE AMPHENOL CORPORATION. NO RIGHTS OF REPRODUCTION ARE IMPLIED. ALL DIMENSIONS ARE SUBJECT TO NORMAL MANUFACTURING VARIATIONS.	
NEXT ASSY:		SIZE: B C-	TYPE: AHD06-18-21PN-SRA
		SCALE: NONE	REVISION: A1

Amphenol



Sine Systems - www.amphenol-sine.com
44724 Morley Drive
Clinton Township, MI 48036



**PLUG, 18 SZ, 21 PIN, REVERSE ARRANGEMENT,
NORMAL SEAL, SRA, DURAMATE AHDP SERIES**

TITLE: PLUG, 18 SZ, 21 PIN, REVERSE ARRANGEMENT, NORMAL SEAL, SRA, DURAMATE AHDP SERIES
DWG NO: AHDP06-18-21PN-SRA
REV: A1
SH: 1
OF: 1



ATM Series™ - Contact Size 20 Options

Machined Contacts, Sockets & Pins				
Part Number	Description	Size	AWG	Type
AT60-010-2031	Male Contact - Pin, Gold-plated	20	16-18	Machined
AT62-005-20141	Female Contact - Socket, Gold-plated	20	16-18	Machined
AT60-010-20141	Male Contact - Pin, Nickel-plated	20	16-18	Machined
AT62-005-2031	Female Contact - Socket, Nickel-plated	20	16-18	Machined
AT60-202-2031	Male Contact - Pin, Gold-plated	20	20-22	Machined
AT62-201-2031	Female Contact - Socket, Gold-plated	20	20-22	Machined
AT60-202-20141	Male Contact - Pin, Nickel-plated	20	20-22	Machined
AT62-201-20141	Female Contact - Socket, Nickel-plated	20	20-22	Machined

Tooling - Machined Contacts		
Part	Part Number	Description
	CA-5D12	Universal Hand Crimp Tool, Size 12/16/20 (Machined contacts only)
	CA-5E12	Pneumatic Crimp Tool, Size 12/16/20 (Machined contacts only)

Contact Removal Tools		
Part	Part Number	Description
	ATRT-100	Used for removal of contacts for A Series™ products
	AT11-240-2005	Contact Removal Tool, Plastic, Size 20
	AT13-204-2005	Sealing Plug, Size 20, White

Stamped & Formed Contacts, Sockets & Pins				
Part Number	Description	Size	AWG	Type
AT60-20-0144	Male Contact - Pin, Gold-plated	20	16-22	Stamped & Formed
AT62-20-0144	Female Contact - Socket, Gold-plated	20	16-22	Stamped & Formed
AT60-20-0244	Male Contact - Socket, Gold-plated	20	16-22	Stamped & Formed
AT62-20-0244	Female Contact - Socket, Gold-plated	20	16-22	Stamped & Formed
AT60-20-0122	Male Contact - Pin, Nickel-plated	20	16-22	Stamped & Formed
AT62-20-0122	Female Contact - Socket, Nickel-plated	20	16-22	Stamped & Formed
AT60-20-0222	Male Contact - Socket, Nickel-plated	20	16-22	Stamped & Formed
AT62-20-0222	Female Contact - Socket, Nickel-plated	20	16-22	Stamped & Formed
AT60-20-0277	Male Contact - Socket, Tin-plated	20	16-22	Stamped & Formed
AT62-20-0277	Female Contact - Socket, Tin-plated	20	16-22	Stamped & Formed
AT60-20-0422	Male Contact - Socket, Nickel-plated	20	20-22	Stamped & Formed
AT62-20-0444	Female Contact - Socket, Gold-plated	20	20-22	Stamped & Formed

Tooling - Stamped & Formed Contacts		
Part	Part Number	Description
	MFX-3974	Crimp Die - Size 20 (S&F contacts only)
	MFX-3976	Crimp Die - Size 20 (S&F contacts only) 20-22AWG -04XX Series
	MFX-3978	Crimp Die - Size 20 (S&F contacts only) 20-22AWG -02XX Series
	ATT-20-00	Hand Crimp Tool - Size 20, 20AWG (S&F contacts only)

Amphenol Sine Systems
 44724 Morley Drive
 Clinton Township, MI 48036 USA
www.amphenol-sine.com
 09/2021