



# EVHF920-S-00B

85VAC/60Hz~350VAC/50Hz  
16.5V/300mA;16.5V/100mA  
Off-line Switching Regulator

## DESCRIPTION

HF920 is a flyback regulator with a monolithic 900V MOSFET. HF920 provides excellent power regulation in AC-DC applications that require high reliability. The switching frequency can be programmed with a single resistor. Also a special frequency doubling mode, designed for strong magnetizing application, can be enabled through a simple external setup.

EVHF920-S-00B evaluation board is specially designed for a better EMC performance with very few EMI filters, which provides reference to effective PCB design for the customer. It features an off-line wide input voltage (85VAC~350VAC) with dual outputs (16.5V/300mA, 16.5V/100mA), and a highly strong anti-interference ability to external magnetic field with the use of transformer core EF20, and is very suitable for the power meter application.

EVHF920-S-00B can meet EN55022 conducted EMI requirements easily with frequency jittering function. It offers a full suite of protective features such as over-temperature protection, VCC under-voltage lockout, over-voltage protection, over-load protection and short-circuit protection.

## ELECTRICAL SPECIFICATION

Parameter	Symbol	Value	Units
Input Voltage	$V_{IN}$	85 to 350	VAC
Output Voltage1	$V_{OUT1}$	16.5	V
Output Current1	$I_{OUT1}$	300	mA
Output Voltage2	$V_{OUT2}$	16.5	V
Output Current2	$I_{OUT2}$	100	mA

## FEATURES

- Wide input voltage (85VAC~350VAC)
- Fixed switching frequency, programmable up to 150kHz
- Frequency doubling operation mode
- Excellent EMC performance
- Over Temperature Protection
- Time-based Over Load Protection
- Short Circuit Protection
- Strong anti-interference ability to external magnetic field
- Power line communications

## APPLICATIONS

- E-Meters
- Industrial controls
- Large appliances

All MPS parts are lead-free, halogen free and adhere to the RoHS directive. For MPS green status, please visit MPS website under Quality Assurance. "MPS" and "The Future of Analog IC Technology", are Registered Trademarks of Monolithic Power Systems, Inc.



**Warning:** Although this board is designed to satisfy safety requirements, the engineering prototype has not been agency approved. Therefore, all testing should be performed using an isolation transformer to provide the AC input to the prototype board.

**EVHF920-S-00B EVALUATION BOARD**

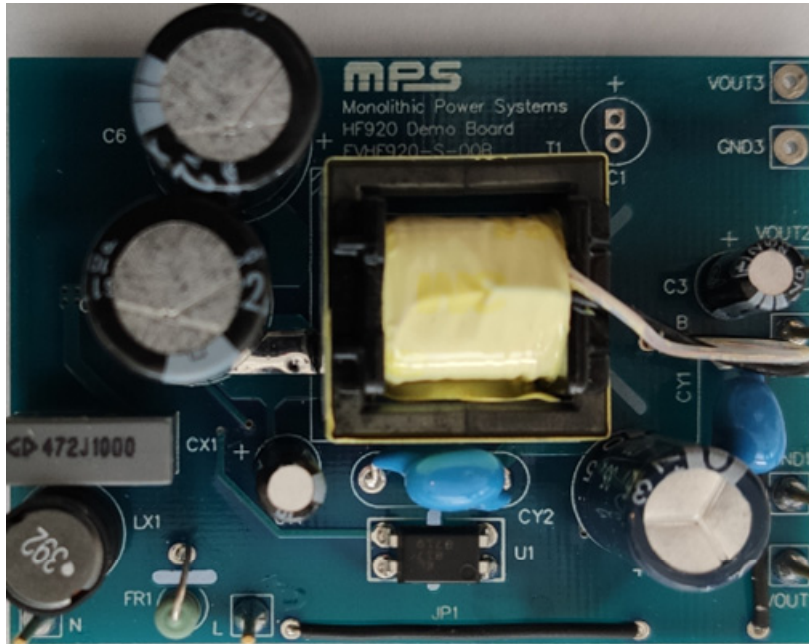

**TOP VIEW**

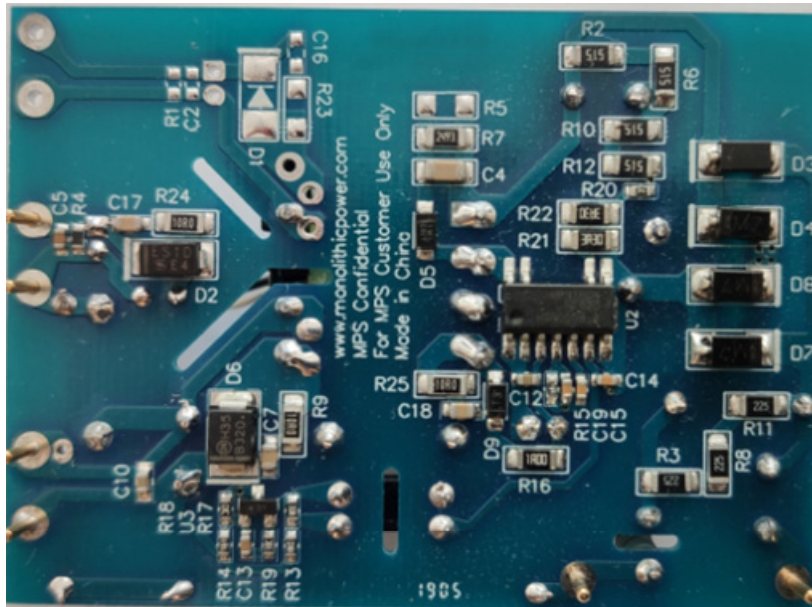

**BOTTOM VIEW**

(L x W x H) 65mm x 47mm x 22mm

Board Number	MPS IC Number
EVHF920-S-00B	HF920GS

### EVALUATION BOARD SCHEMATIC

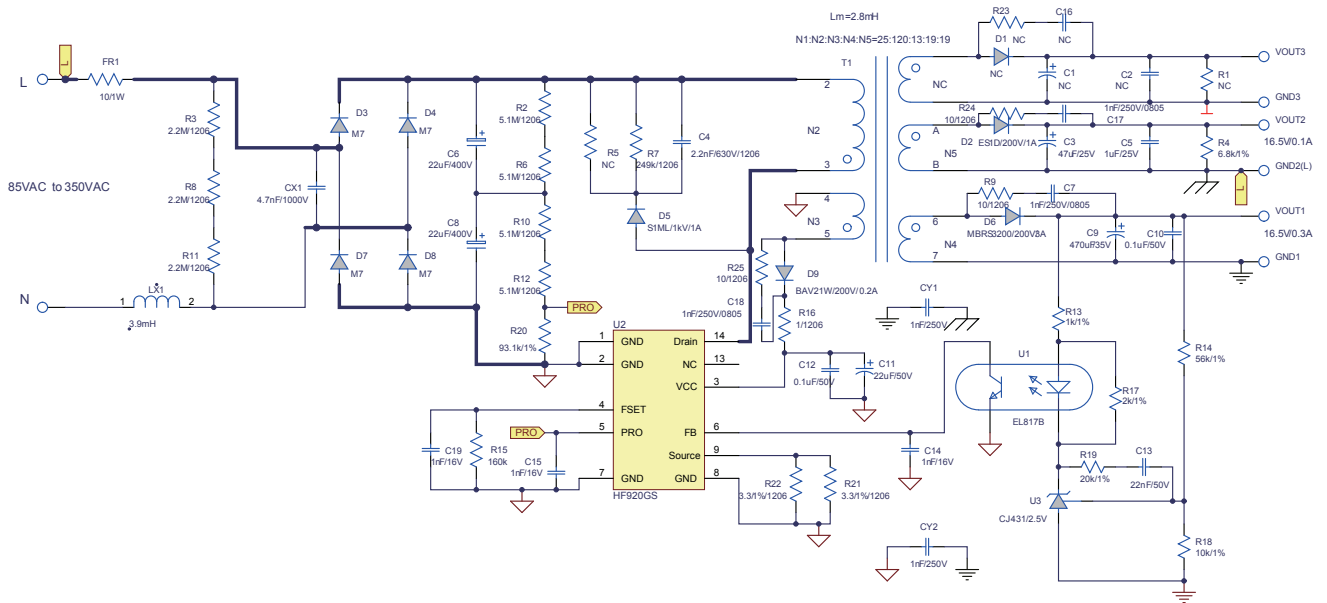

Figure 1: Schematic

**EVHF920-S-00B BILL OF MATERIALS**

Qty	Ref	Value	Description	Package	Manufacturer	Manufacturer_P/N
1	C3	47 $\mu$ F	Electrolytic Capacitor;25V	DIP	Jianghai	CD28L-25V47
1	C5	1 $\mu$ F	Ceramic Capacitor;25V;X7R	0603	Murata	GRM188R71E2105KA12D
1	C4	2.2nF	Ceramic Capacitor;630V;X7R	1206	Murata	GRM31BR72J222KW01L
2	C6,C8	22 $\mu$ F	Electrolytic Capacitor;400V	DIP	Rubycon	400PX22MEFC12.5X20
3	C7,C17,C18	1nF	Ceramic Capacitor;250V;X7R	0805	Murata	GRM21AR72E102KW01D
1	C9	470 $\mu$ F	Ceramic Capacitor;35V	DIP	Jianghai	CD263-35V470
2	C10,C12	100nF	Ceramic Capacitor;50V	0603	Wurth	885012206095
1	C11	22 $\mu$ F	Electrolytic Capacitor;50V	DIP	Rubycon	50YXM22MEFC5*11
1	C13	22nF	Ceramic Capacitor;50V	0603	Murata	GRM188R71H223KA01D
3	C14,C15,C19	1nF	Ceramic Capacitor;16V	0603	Wurth	885012206034
1	CX1	4.7nF	X Capacitor 1000V	DIP	Fara	MMKP82-1000V-472P1
2	CY1,CY2	1nF	Y Capacitor;250V;20%	DIP	Hongke	JNK09E102MY02N
1	D2	ES1D	Schottky Diode;200V;1A	SMA	Diodes	Taiwan
4	D3, D4, D7, D8	M7	Diode;1000V;1A	SMA	Diodes	Toshiba
1	D5	S1ML	Diode;1000V;1A;	SOD123	Diodes	Taiwan
1	D6	MBRS3200T3G	Schottky Diode;200V;3A	SMB	Onsemi	MBRS3200TS3G
1	D9	BAV21W	Diode;200V;0.2A;	SOD123	Diodes	BAV21W-7-F
1	LX1	7447452392	3.9mH	DIP	Wurth	7447452392
1	FR1	10	Fuse Resistor;5%;1W	DIP	Yageo	FKN1WSJT-52-10R
1	R4	6.8k	Film Resistor;1%	0603	Yageo	RC0603FR-076K8L
4	R2, R6, R10, R12	5.1M	Film Resistor;5%;1/4W	1206	Yageo	RI1206L515JT
3	R3, R8, R11	2.2M	Film Resistor;5%;1/4W	1206	Royalohm	1206J0225T5E
1	R7	249k	Film Resistor;5%;1/4W	1206	Yageo	RC1206FR-07249KL
3	R9, R24,R25	10	Film Resistor;1%;1/4W	1206	Yageo	RC1206FR-0710RL
1	R13	1k	Film Resistor;1%	0603	Yageo	RC0603FR-071KL
1	R14	56k	Film Resistor;1%	0603	Yageo	RC0603FR-0756KL
1	R15	160k	Film Resistor;1%	0603	Yageo	RC0603FR-07160KL
1	R16	1	Film Resistor;1%	1206	Yageo	RC1206FR-071RL
1	R17	2k	Film Resistor;1%	0603	Yageo	RC0603FR-072KL

**EVHF920-S-00B BILL OF MATERIALS**

Qty	Ref	Value	Description	Package	Manufacturer	Manufacturer_P/N
1	R18	10k	Film Resistor;1%	0603	Yageo	RC0603FR-0710KL
1	R19	20k	Film Resistor;1%	0603	Yageo	RC0603FR-0720KL
1	R20	93.1k	Film Resistor;1%	0603	Yageo	RC0603FR-0793K1L
2	R21,R22	3.3	Film Resistor;1%;1/4W	1206	Yageo	RC1206FR-073R3L
1	U2	HF920GS	Flyback regulator with 900V integrated MOS	SOIC14-11	MPS	HF920GS R1
1	U1	EL817B	Photocoupler;1-Channel	DIP	Everlight	EL817B
1	U3	CJ431	2.5V voltage reference	SOT23	Diodes	CJ431
1	T1	EF20	EF20, 2.8mH, N1:N2:N3:N4:N5=25:120:13:19:19	DIP	Emei(1)	FX0556
6	L,N,VOUT1, VOUT2, GND1,GND2	Connector	1.0mm			
1	JP1		28mm			
1	JP2		22.6mm			
10	C1,C2,C16, D1,R1,R23,V OUT3,GND3 ,R5		NC			

**Notes:**

1) Emei transformer sample request please login on website: [www.emeigroup.com](http://www.emeigroup.com)

## EVB TEST RESULTS

Performance waveforms are tested on the evaluation board.

$V_{IN} = 230VAC$ ,  $V_{OUT1} = 16.5V$ ,  $I_{OUT1} = 300mA$ ,  $V_{OUT2} = 16.5V$ ,  $I_{OUT2} = 100mA$ ,  $T_A = 25^{\circ}C$ , unless otherwise noted.

**Efficiency**

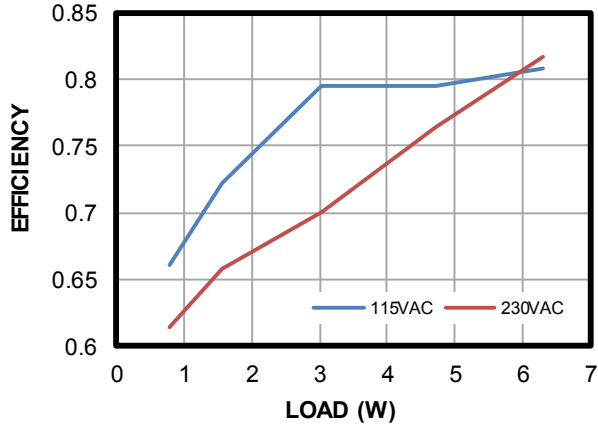

**No Load Consumption**

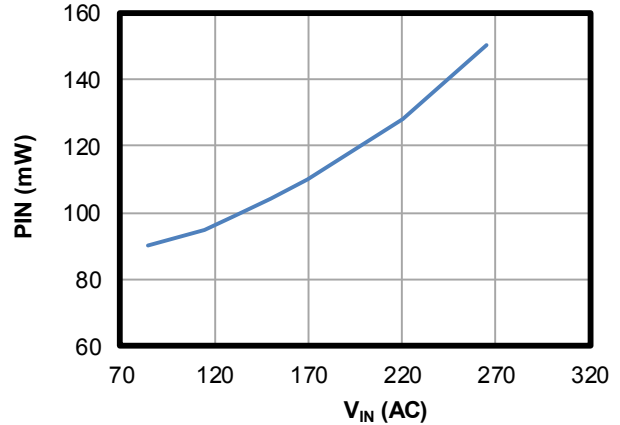

**Power On**

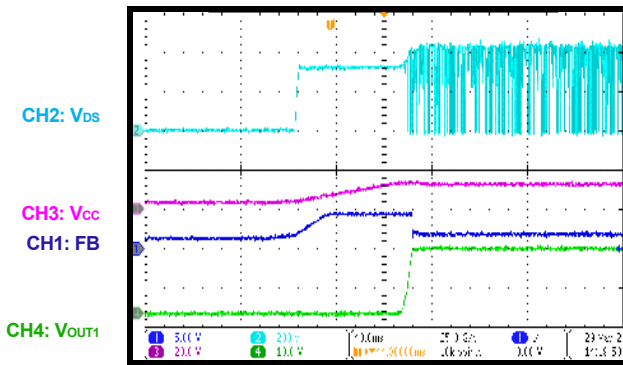

**Power Off**

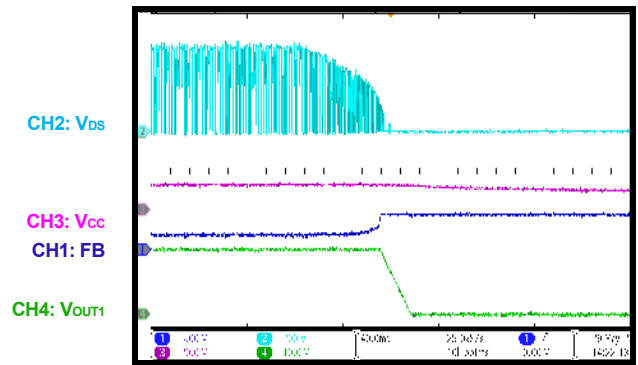

**Normal Operation**

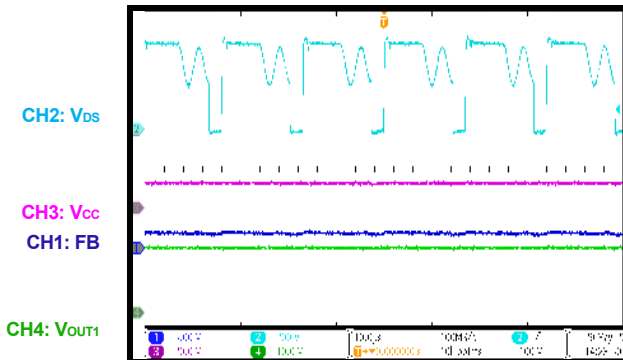

**Short Circuit Entry**

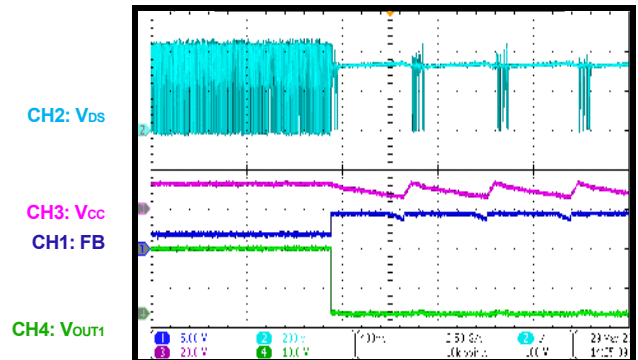

**TYPICAL PERFORMANCE CHARACTERISTICS** *(continued)*

Performance waveforms are tested on the evaluation board.

 $V_{IN} = 230VAC$ ,  $V_{OUT1} = 16.5V$ ,  $I_{OUT1} = 300mA$ ,  $V_{OUT2} = 16.5V$ ,  $I_{OUT2} = 100mA$ ,  $T_A = 25^{\circ}C$ , unless otherwise noted.

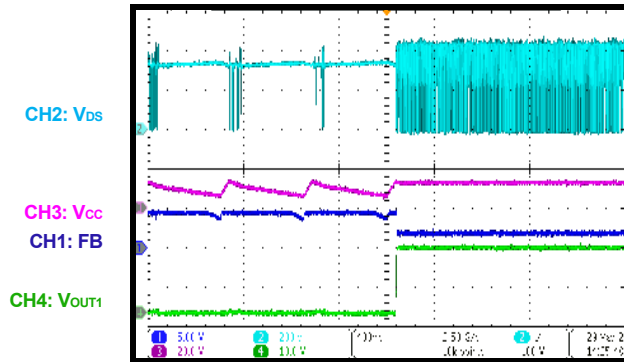
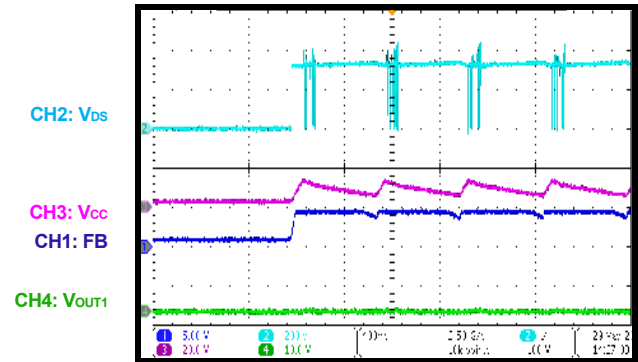
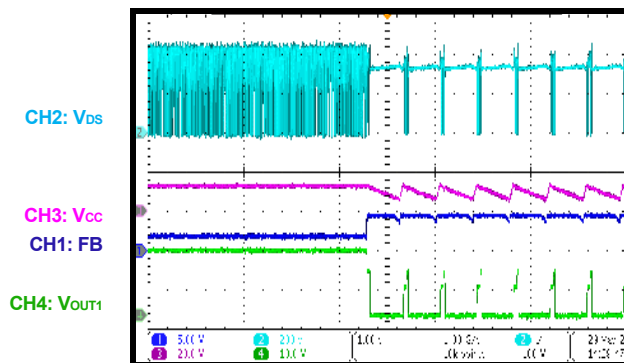
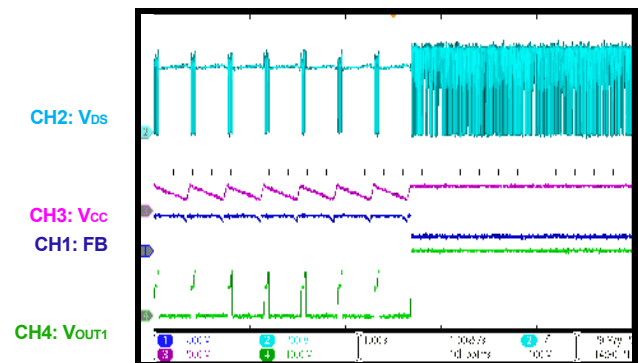
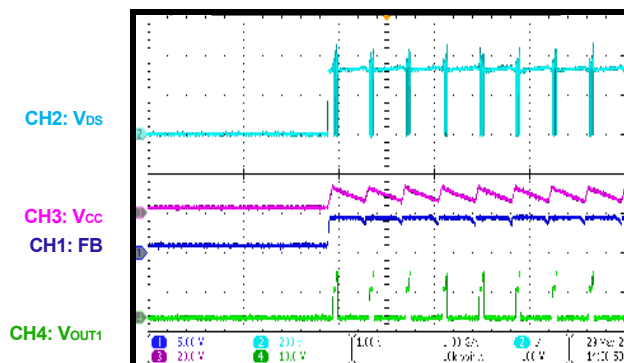
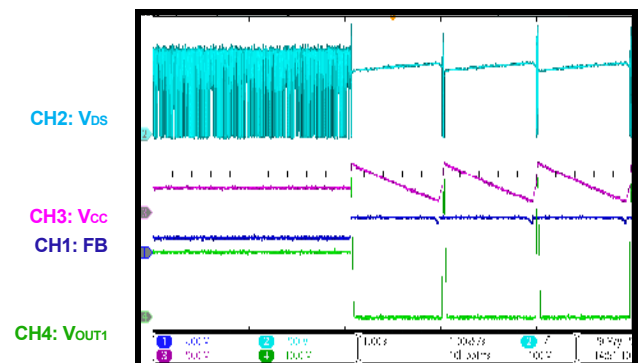
**Short Circuit Recovery**

**Short Circuit Power On**

**OLP Entry**

**OLP Recovery**

**OLP Power On**

**OVP Entry**





PCB LAYOUT (DUAL-SIDED)

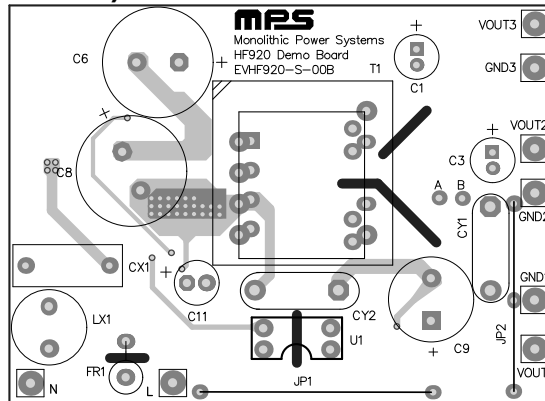

Figure 2: Top Layer

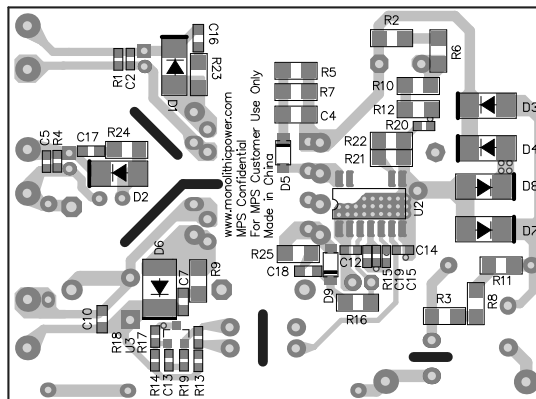

Figure 3: Bottom Layer

## TRANSFORMER SPECIFICATION

### Electrical Diagram

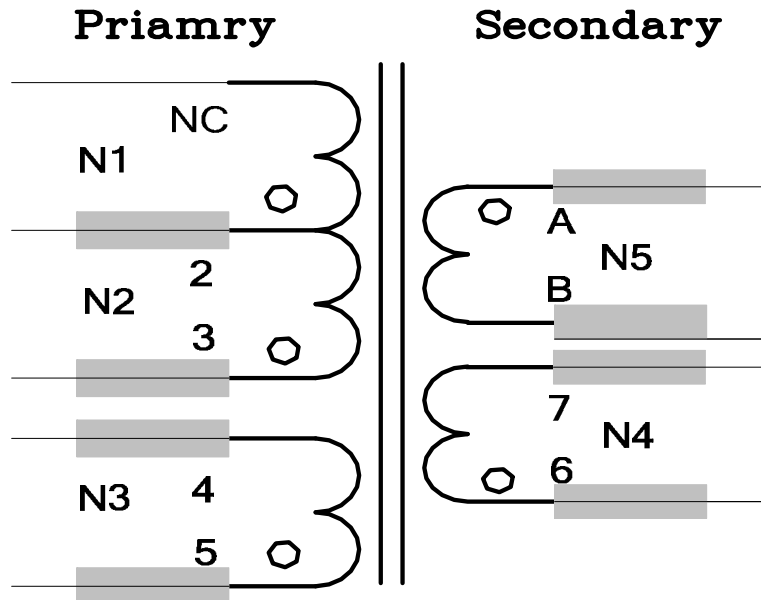

Figure 4: Transformer Electrical Diagram

#### Notes:

1. All winding terminals are added tube;
2. N5 is flying out from the bobbin. Terminal A is labeled with white and terminal B is labeled with black;
3. Remove Pin1, Pin8 and Pin10;
4. Varnish the transformer.

### Winding Diagram

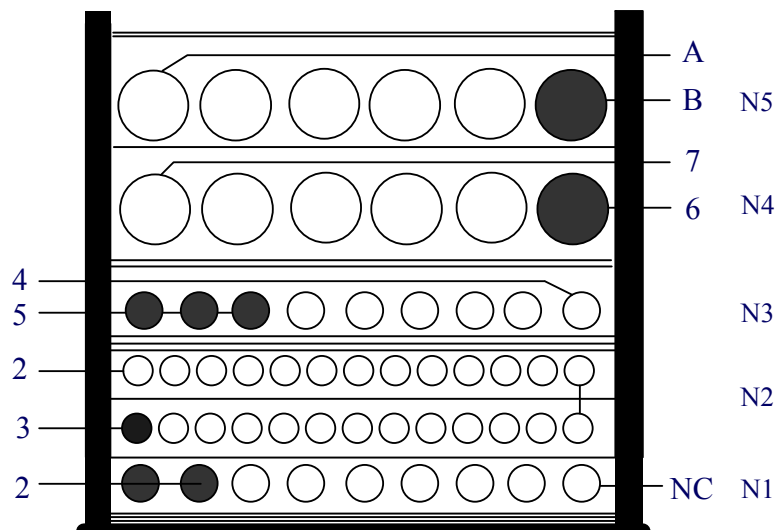

Figure 5: Winding Diagram

### Winding Order

**Electrical Specifications**
**Winding Order**

Winding No.	Tape Layer No.	Start & End	Magnet Wire $\phi$ (mm)	Turns
N1	1	2—\(\rightarrow\) NC	0.22mm*2	25
N2	1	3—\(\rightarrow\) 2	0.15mm*1	120
N3	1	5—\(\rightarrow\) 4	0.22mm*3	13
N4	1	6—\(\rightarrow\) 7	0.28mm*1 TIW	19
N5	1	B—\(\rightarrow\) A	0.28mm*1 TIW	19
<b>Primary Inductance</b>		Pins 2-3, all other windings open, measured at 60kHz, 0.1VRMS		2.8mH $\pm$ 5%

**Materials**

Item	Description
1	Core: EF20, UI=2300 $\pm$ 25%, AL=1570nH/N <sup>2</sup> $\pm$ 25% UNGAPPED
2	Bobbin: EF20 Horizontal, 6+6PIN 1SECT T-H
3	Wire: $\Phi$ 0.22mm, 2UEW, Class B
4	Wire: $\Phi$ 0.15mm, 2UEW, Class B
5	Wire: $\Phi$ 0.28mm, 2UEW, Class B
6	Tape: 12.5mm(W) $\times$ 0.06mm(TH)
7	Tube: #26 BLACK; #26 CLEAR; #30 CLEAR; #23 CLEAR
8	Varnish: JOHN C. DOLPH CO, BC-346A or equivalent
9	Solder Bar: CHEN NAN: SN99.5/Cu0.5 or equivalent

## CIRCUIT DESCRIPTION

EVHF920-S-00B is designed for smart power meter application with a total two output power of 6.6W. One output with GND2 connected to L line is designed for the power line communications (PLC) supply, the other is used to power the LCD for MCU.

FR1 is used to protect for the component failure or some excessive short events, also it can restrain the inrush current.

To meet the EN55022 standard, X-CAP CX1 and differential mode inductor LX1 is employed to filter EMI noise.

The diode-bridge rectifier, which is composed of D3, D4, D7 and D8, transforms input AC voltage to the dc-bus voltage.

C6 and C8 are connected in series for a high input voltage energy storage, which help to reduce line noise and protect the input against the line surge. R2, R6, R10, R12 and R20 are employed to balance the voltage on C6 and C8, and prevent the input over voltage.

The primary RCD consists of R7, C4 and D5, and it can restrain the high voltage spike to protect the MOSFET from damage.

R15 is for switching frequency options, which should be positioned far away from the data

sampling frequency in power meter applications to avoid unwanted noise disturbance. Moreover, a low switching frequency is commonly used to get good thermal performance under high input voltage application. C19, typically 1nF, is used for double frequency mode selection.

C11 is the power supply capacitor for Vcc, and the ceramic C12 is used in parallel with C11 to decouple the voltage noise, it should be positioned to IC as close as possible.

R21, R22 are the current sense resistors with 1% tolerance for peak current setup.

The output electrolytic capacitor C3, C9 is used to satisfy the requirement for output voltage ripple.

R4 is dummy load to regulate the output voltage within designed value.

R14, R18 are configured to set the output voltage. The control loop composed of U1, U3, R19 and C13 feedbacks output voltage instantaneous value to FB pin. To obtain good dynamic response and high stability of system, the control loop has been carefully designed.

The input L Line is connected to GND2 for the PLC in power meter.

## QUICK START GUIDE

1. Preset power supply to  $85\text{VAC} \leq V_{\text{IN}} \leq 350\text{VAC}$ .
2. Turn power supply off.
3. Connect the Line and Neutral terminals of the power supply output to L and N port.
4. Connect different loads to corresponding outputs:
  - a. Positive (+): VOUTX
  - b. Negative (-): GNDX
5. Turn power supply on after making connections.

**NOTICE:** The information in this document is subject to change without notice. Please contact MPS for current specifications. Users should warrant and guarantee that third party Intellectual Property rights are not infringed upon when integrating MPS products into any application. MPS will not assume any legal responsibility for any said applications.