

T-39-21

INTERNATIONAL RECTIFIER

INTERNATIONAL RECTIFIER 

HEXFET® TRANSISTORS

IRF9Z30

IRF9Z32

**P-CHANNEL
50 VOLT
POWER MOSFETs**

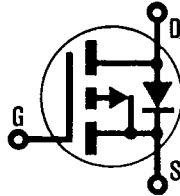

**-50 Volt, 0.14 Ohm, HEXFET
TO-220AB Plastic Package**

The HEXFET® technology is the key to International Rectifier's advanced line of power MOSFET transistors. The efficient geometry and unique processing of the HEXFET design achieve very low on-state resistance combined with high transconductance and extreme device ruggedness.

The P-Channel HEXFETs are designed for applications which require the convenience of reverse polarity operation. They retain all of the features of the more common N-Channel HEXFETs such as voltage control, very fast switching, ease of paralleling, and excellent temperature stability.

P-Channel HEXFETs are intended for use in power stages where complementary symmetry with N-Channel devices offers circuit simplification. They are also very useful in drive stages because of the circuit versatility offered by the reverse polarity connection. Applications include motor control, audio amplifiers, switched mode converters, control circuit and pulse amplifiers.

Features

- P-Channel Versatility
- Compact Plastic Package
- Fast Switching
- Low Drive Current
- Ease of Paralleling
- Excellent Temperature Stability

Product Summary

| Part Number | V _{DS} | R _{DS(on)} | I _D |
|-------------|-----------------|---------------------|----------------|
| IRF9Z30 | -50V | 0.14Ω | -18A |
| IRF9Z32 | -50V | 0.21Ω | -15A |

TO-220

CASE STYLE AND DIMENSIONS

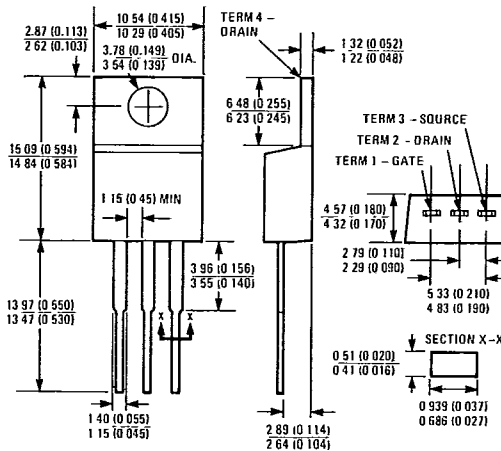
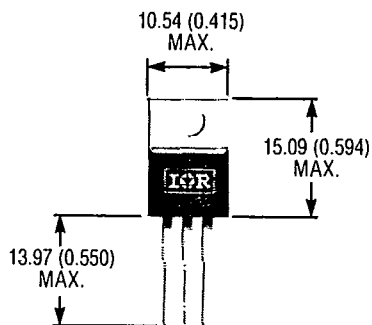

Case Style TO-220AB
Dimensions in Millimeters and (Inches)

Absolute Maximum Ratings

| Parameter | IRF9Z30 | IRF9Z32 | Units |
|--|---|---------|-------|
| V _{DS} Drain - Source Voltage ① | -50 | -50 | V |
| V _{DGR} Drain - Gate Voltage (R _{GS} = 20 K Ω) ① | -50 | -50 | V |
| I _D @ T _C = 25°C Continuous Drain Current | -18 | -15 | A |
| I _D @ T _C = 100°C Continuous Drain Current | -11 | -9.3 | A |
| I _{DM} Pulsed Drain Current ② | -60 | -50 | A |
| V _{GS} Gate - Source Voltage | ± 20 | | V |
| P _D @ T _C = 25°C Max. Power Dissipation | 74 | | W |
| Linear Derating Factor | 0.59 | | W/K ③ |
| I _{LM} Inductive Current, Clamped | (See Fig. 14) L = 100 μ H -60 -50 | | A |
| I _L Unclamped Inductive Current (Avalanche Current) ③ | (See Fig. 15) -3.1 | | A |
| T _J Operating Junction and Storage Temperature Range | -55 to 150 | | °C |
| T _{stg} Lead Temperature | 300 (0.063 in. (1.6mm) from case for 10s) | | °C |

Electrical Characteristics @ T_C = 25°C (Unless Otherwise Specified)

| Parameter | Type | Min. | Typ. | Max. | Units | Test Conditions |
|--|--------------------|------------|---------------|------|----------|--|
| BV _{DSS} Drain - Source Breakdown Voltage | IRF9Z30 IRF9Z32 | -50 | - | - | V | V _{GS} = 0V I _D = -250 μ A |
| V _{GS(th)} Gate Threshold Voltage | ALL | -2.0 | - | -4.0 | V | V _{DS} = V _{GS} , I _D = -250 μ A |
| I _{GSS} Gate-Source Leakage Forward | ALL | - | - | -500 | nA | V _{GS} = -20V |
| I _{GSS} Gate-Source Leakage Reverse | ALL | - | - | 500 | nA | V _{GS} = 20V |
| I _{DSS} Zero Gate Voltage Drain Current | ALL | - | - | -250 | μ A | V _{DS} = Max. Rating, V _{GS} = 0V |
| I _{D(on)} On-State Drain Current ④ | IRF9Z30 IRF9Z32 | -18 -15 | - | - | A | V _{DS} = Max. Rating \times 0.8, V _{GS} = 0V, T _C = 125°C |
| R _{DS(on)} Static Drain-Source On-State Resistance ④ | IRF9Z30 IRF9Z32 | - | 0.093 0.14 | 0.14 | Ω | V _{GS} = -10V, I _D = -9.3A |
| g _{fs} Forward Transconductance ④ | ALL | 3.1 | 4.7 | - | S (f) | V _{DS} = 2 \times V _{GS} , I _{DS} = -9.0A |
| C _{iss} Input Capacitance | ALL | - | 900 | - | pF | V _{GS} = 0V, V _{DS} = -25V, f = 1.0 MHz |
| C _{oss} Output Capacitance | ALL | - | 670 | - | pF | See Fig. 10 |
| C _{rss} Reverse Transfer Capacitance | ALL | - | 140 | - | pF | |
| t _{d(on)} Turn-On Delay Time | ALL | - | 12 | 18 | ns | V _{DD} = -25V, I _D = -18A, R _G = 13 Ω , R _D = 1.3 Ω |
| t _r Rise Time | ALL | - | 110 | 170 | ns | See Fig. 16 |
| t _{d(off)} Turn-Off Delay Time | ALL | - | 21 | 32 | ns | (MOSFET switching times are essentially independent of operating temperature.) |
| t _f Fall Time | ALL | - | 64 | 96 | ns | |
| Q _g Total Gate Charge (Gate-Source Plus Gate-Drain) | ALL | - | 26 | 39 | nC | V _{GS} = -10V, I _D = -18A, V _{DS} = 0.8 Max. Rating. See Fig. 17 for test circuit. (Gate charge is essentially independent of operating temperature.) |
| Q _{gs} Gate-Source Charge | ALL | - | 6.9 | 10 | nC | |
| Q _{gd} Gate-Drain ("Miller") Charge | ALL | - | 9.7 | 15 | nC | |
| L _D Internal Drain Inductance | ALL | - | 4.5 | - | nH | Measured from the drain lead, 6mm (0.25 in.) from package to center of die. |
| L _S Internal Source Inductance | ALL | - | 7.5 | - | nH | Measured from the source lead, 6mm (0.25 in.) from package to source bonding pad. |

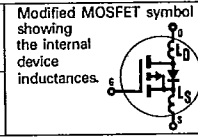

Thermal Resistance

| | | | | | | |
|---------------------------------------|-----|---|-----|-----|-------|---|
| R _{thJC} Junction-to-Case | ALL | - | - | 1.7 | K/W ⑤ | |
| R _{thCS} Case-to-Sink | ALL | - | 1.0 | - | K/W ⑤ | Mounting surface flat, smooth, and greased. |
| R _{thJA} Junction-to-Ambient | ALL | - | - | 80 | K/W ⑤ | Typical socket mount |

INTERNATIONAL RECTIFIER

Source-Drain Diode Ratings and Characteristics

T-39-21

| | | | | | | | |
|----------|--|---------|--|------|------|---------------|---|
| I_S | Continuous Source Current (Body Diode) | IRF9Z30 | — | — | -18 | A | Modified MOSFET symbol showing the integral reverse PN junction rectifier.  |
| | | IRF9Z32 | — | — | -15 | A | |
| I_{SM} | Pulse Source Current (Body Diode) ③ | IRF9Z30 | — | — | -60 | A | |
| | | IRF9Z32 | — | — | -50 | A | |
| V_{SD} | Diode Forward Voltage ② | ALL | — | — | -6.3 | V | $T_C = 25^\circ\text{C}, I_S = -18\text{A}, V_{GS} = 0\text{V}$ |
| t_{rr} | Reverse Recovery Time | ALL | 54 | 120 | 250 | ns | $T_J = 25^\circ\text{C}, I_F = -18\text{A}, dI_F/dt = 100\text{A}/\mu\text{s}$ |
| Q_{RR} | Reverse Recovered Charge | ALL | 0.20 | 0.47 | 1.1 | μC | $T_J = 25^\circ\text{C}, I_F = -18\text{A}, dI_F/dt = 100\text{A}/\mu\text{s}$ |
| t_{on} | Forward Turn-on Time | ALL | Intrinsic turn-on time is negligible. Turn-on speed is substantially controlled by $L_S + L_D$. | | | | |

- ① $T_J = 25^\circ\text{C}$ to 150°C
- ② Repetitive Rating: Pulse width limited by max. junction temperature. See Transient Thermal Impedance Curve (Fig. 5).
- ③ @ $V_{dd} = -25\text{V}, T_J = 25^\circ\text{C}$
- ④ Pulse Test: Pulse width $\leq 300 \mu\text{s}$, Duty Cycle $\leq 2\%$
- ⑤ $K/W = ^\circ\text{C}/\text{W}$
- $W/K = \text{W}/^\circ\text{C}$

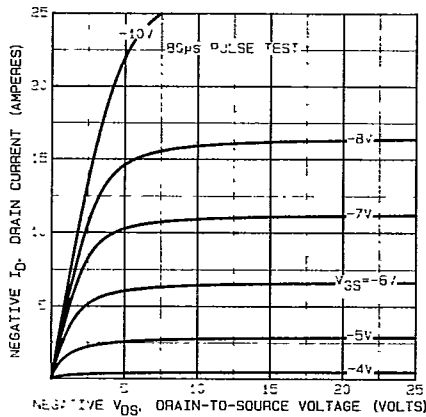

Fig. 1 — Typical Output Characteristics

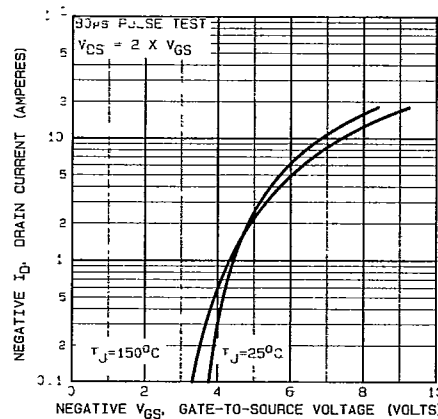

Fig. 2 — Typical Transfer Characteristics

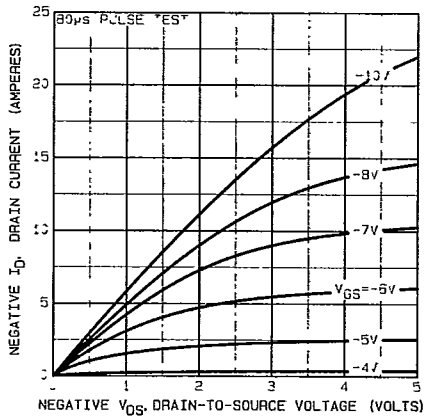

Fig. 3 — Typical Saturation Characteristics

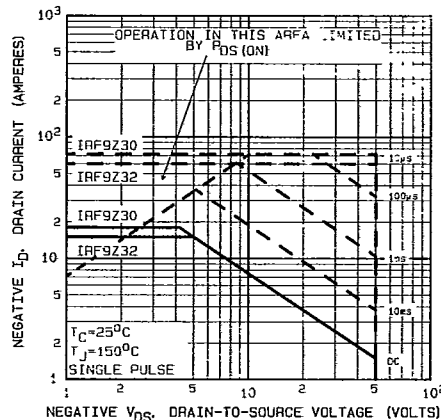

Fig. 4 — Maximum Safe Operating Area

IRF9Z30, IRF9Z32 Devices

INTERNATIONAL RECTIFIER

T-39-21

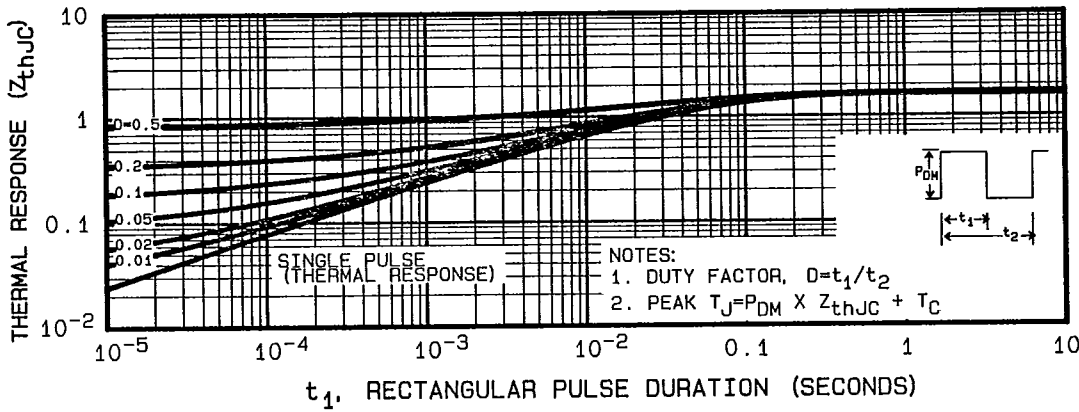

Fig. 5 — Maximum Effective Transient Thermal Impedance, Junction-to-Case Vs. Pulse Duration

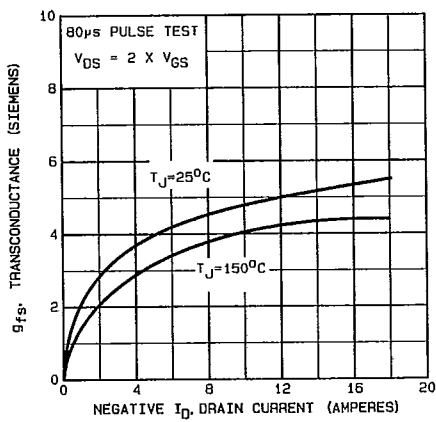

Fig. 6 — Typical Transconductance Vs. Drain Current

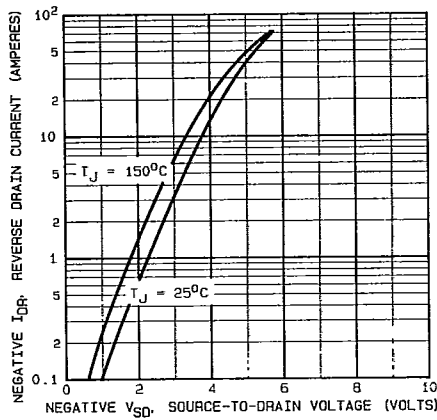

Fig. 7 — Typical Source-Drain Diode Forward Voltage

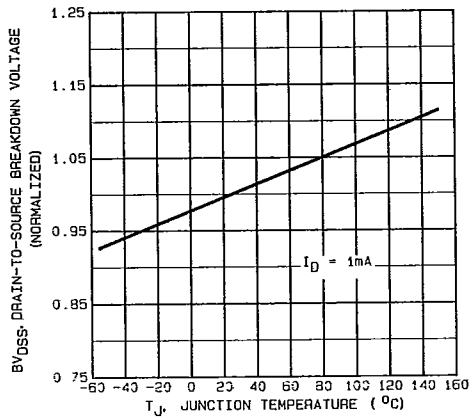

Fig. 8 — Breakdown Voltage Vs. Temperature

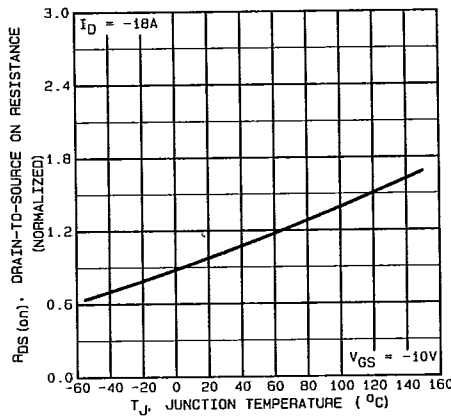

Fig. 9 — Normalized On-Resistance Vs. Temperature

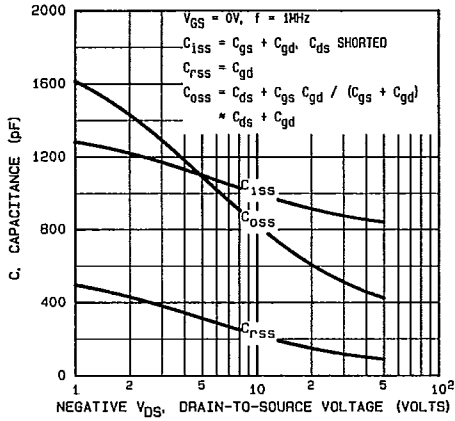

Fig. 10 — Typical Capacitance Vs. Drain-to-Source Voltage

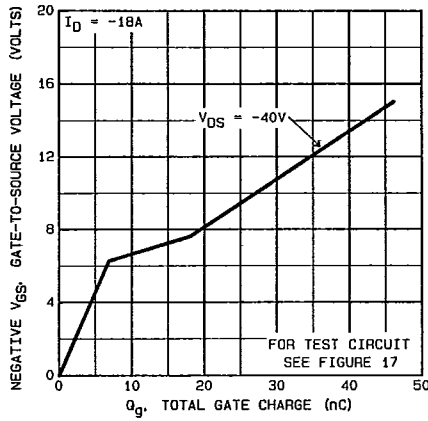

Fig. 11 — Typical Gate Charge Vs. Gate-to-Source Voltage

T0-220

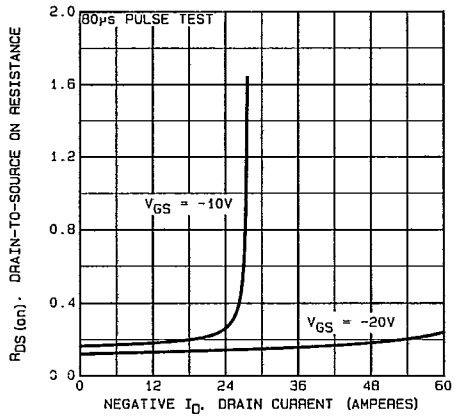

Fig. 12 — Typical On-Resistance Vs. Drain Current

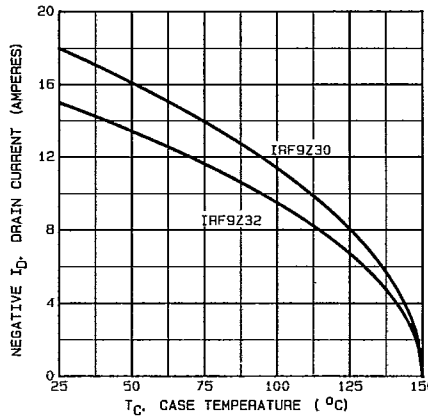

Fig. 13 — Maximum Drain Current Vs. Case Temperature

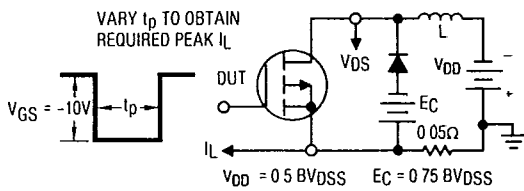

Fig. 14a — Clamped Inductive Test Circuit

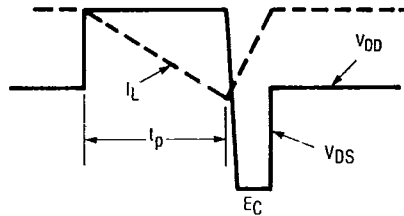

Fig. 14b — Clamped Inductive Waveforms

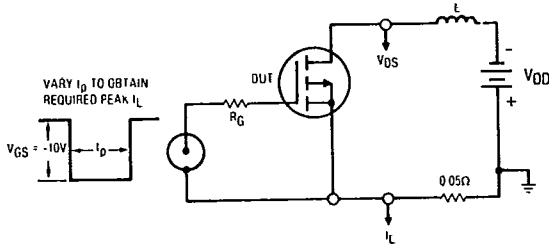

Fig. 15a — Unclamped Inductive Test Circuit

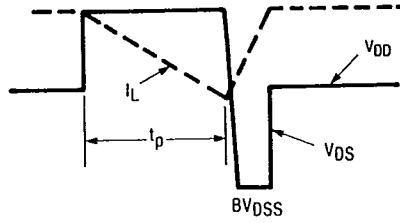

Fig. 15b — Unclamped Inductive Load Test Waveforms

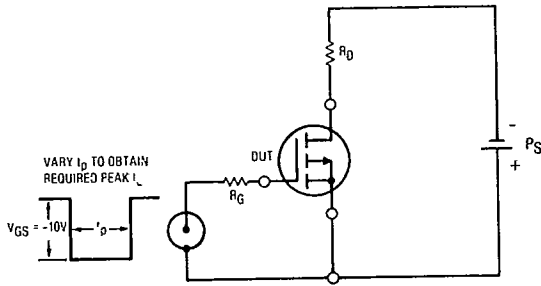

Fig. 16 — Switching Time Test Circuit

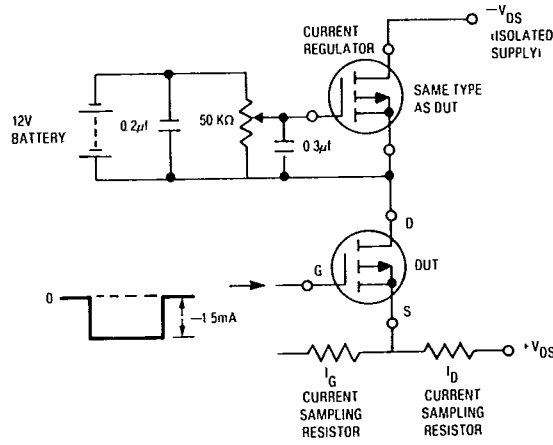
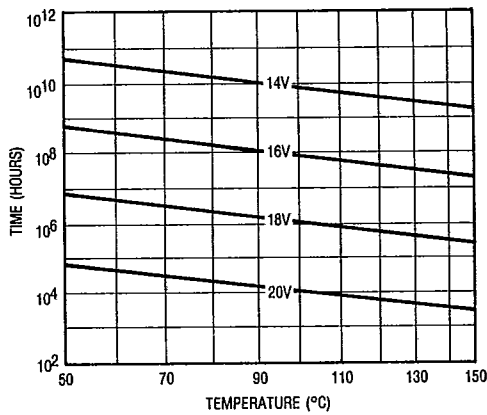
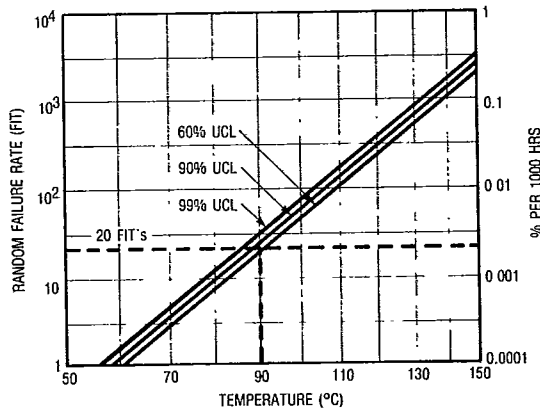

Fig. 17 — Gate Charge Test Circuit



*Fig. 18 — Typical time to Accumulated 1% Gate Failure



*Fig. 19 — Typical High Temperature Reverse Bias (HTRB) Failure Rate

*The data shown is correct as of April 15, 1987. This information is updated on a quarterly basis; for the latest reliability data, please contact your local IR field office.