

## CPDT6-5V4C-HF

RoHS Device  
Halogen Free

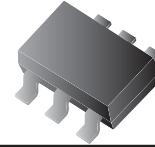

### Features

- Bi-directional ESD protection.
- IEC61000-4-2 Level 4 ESD protection.
- Operating voltage: 5V.

### Mechanical data

- Case: SOT-23-6 Standard package,  
molded plastic.
- Terminals: solderable per  
MIL-STD-750, method 2026.
- Marking code: E54
- Mounting position: Any.
- Weight: 0.015 gram (approx.).

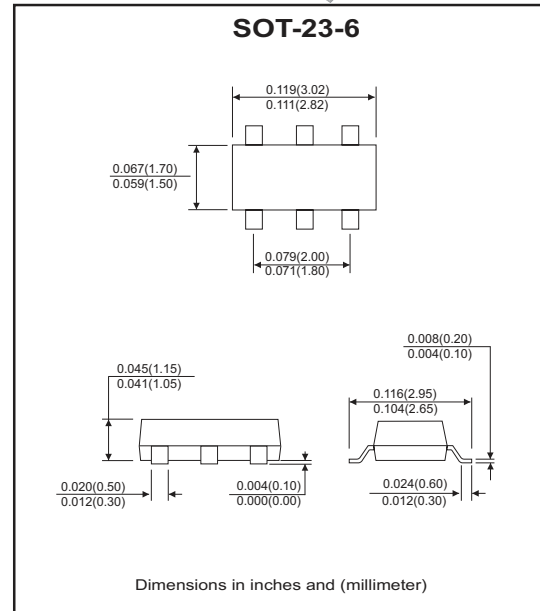

### Circuit diagram

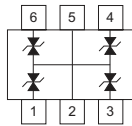

### Electrical Characteristics (at TA=25°C unless otherwise noted)

Parameter	Conditions	Symbol	Min	Typ	Max	Unit
Diode breakdown voltage	I <sub>R</sub> = 1mA	V <sub>BD</sub>	6.1	7.0		V
Leakage current	V <sub>R</sub> = 5V	I <sub>L</sub>		0.1	2.0	uA
Junction capacitance	V <sub>R</sub> = 0V, f = 1MHz	C <sub>T</sub>		25	30	pF
ESD capability	IEC 61000-4-2(air) IEC 61000-4-2(contact)	ESD			16 8	kV
Operation temperature		T <sub>j</sub>			125	°C
Storage temperature		T <sub>STG</sub>	-55		150	°C

## RATING AND CHARACTERISTIC CURVES (CPDT6-5V4C-HF)

Fig. 1 - Reverse characteristics

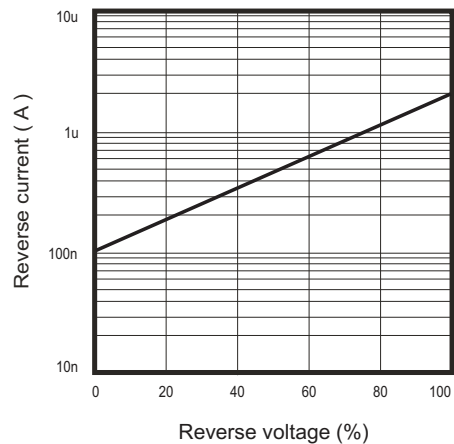

Fig. 2 - Capacitance between terminals characteristics

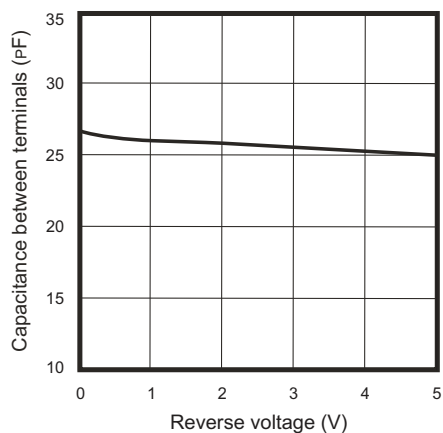
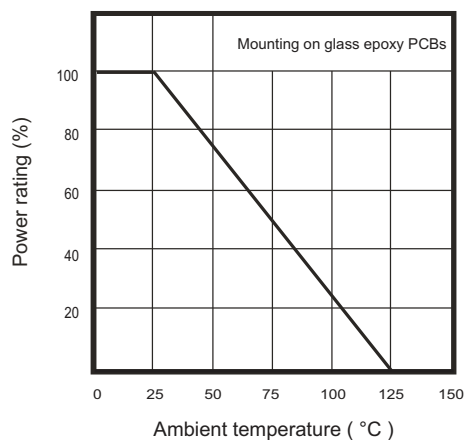
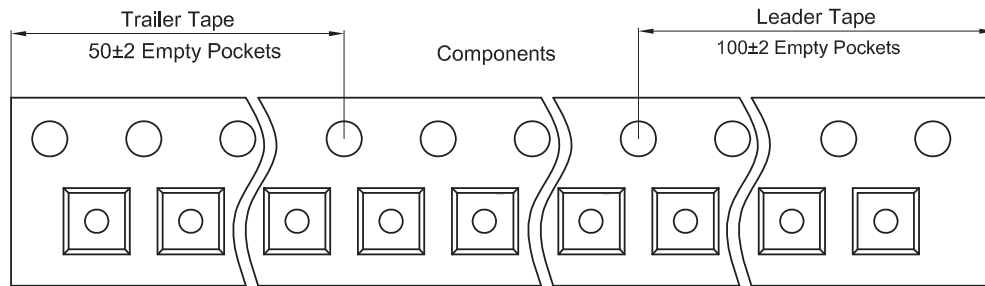
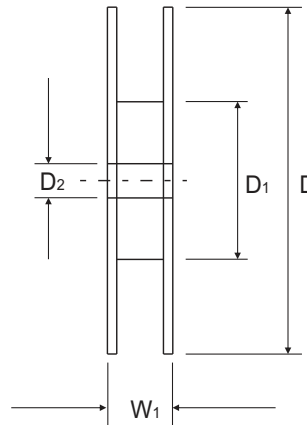
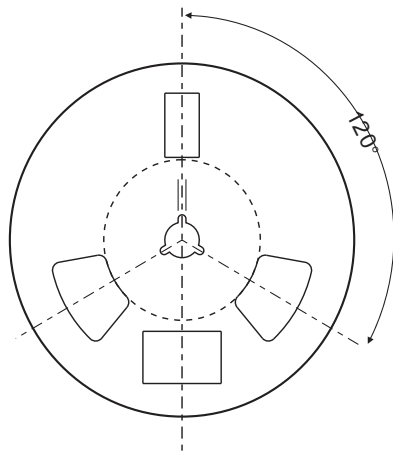
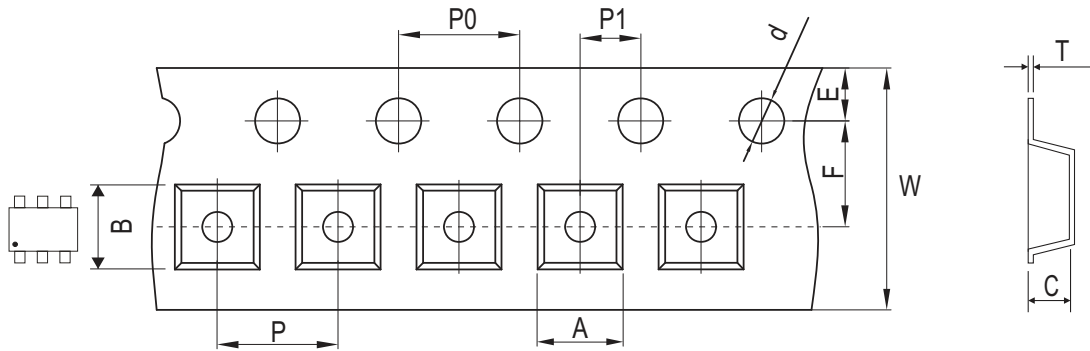

Fig. 3 - Power rating derating curve



## Reel Taping Specification



SOT-23-6	SYMBOL	A	B	C	d	D	D1	D2
	(mm)	3.17 ± 0.10	3.23 ± 0.10	1.37 ± 0.10	1.50 ± 0.05	180.0 + 0.00 / - 0.30	60.00 ± 0.50	13.00 ± 0.20
	(inch)	0.125 ± 0.004	0.127 ± 0.004	0.054 ± 0.004	0.059 ± 0.002	7.087 + 0.00 / - 0.012	2.362 ± 0.020	0.512 ± 0.008

SOT-23-6	SYMBOL	E	F	P	P0	P1	W	W1
	(mm)	1.75 ± 0.10	3.50 ± 0.05	4.00 ± 0.10	4.00 ± 0.10	2.00 ± 0.05	8.00 + 0.30 / - 0.10	12.30 ± 0.20
	(inch)	0.069 ± 0.004	0.138 ± 0.002	0.157 ± 0.004	0.157 ± 0.004	0.079 ± 0.002	0.315 + 0.012 / - 0.004	0.484 ± 0.008

## Marking Code

Part Number	Marking Code
CPDT6-5V4C-HF	E54

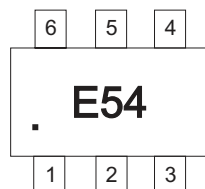

## Suggested PAD Layout

SIZE	SOT-23-6	
	(mm)	(inch)
A	1.10	0.043
B	0.60	0.024
C	1.90	0.075
D	2.50	0.098
E	3.60	0.142

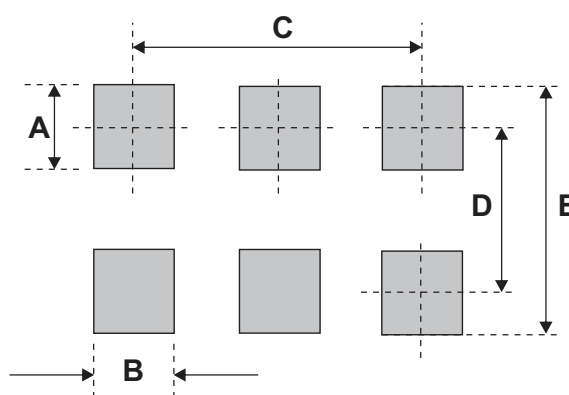

## Standard Packaging

Case Type	REEL PACK	
	REEL ( pcs )	Reel Size (inch)
SOT-23-6	3,000	7