	Date	01-Dec-2022	SPECIFICATION	OLE WOLFF
	Page	1 / 8		www.owolff.com
	DK	P/N: OWS-111535W50A-8		Revision: 00



SPECIFICATION FOR APPROVAL

Speaker

Part Number	OWS-111535W50A-8
Note	This item was compliance with the following requirements: 1. RoHS directive 2. REACH
Customer P/N	

Ole Wolff	Signature / Date	Prepared	Checked	Approved
		HOZHUIJIE 2022.12.01		

Customer	Signature / Date	Confirmation		

REVISION NOTES:

Date	Rev.	Description of Revision
2022.12.01	00	Initial Release

OLE WOLFF ELEKTRONIK A/S Roedengvej 25 4180 Soroe Denmark TEL: +45 57833830 FAX: +45 57820019	OLE WOLFF ELECTRONICS INC. 1525 McCarthy Blvd, Suite 1093 Milpitas, Ca 95035 USA TEL: +1 408 888 8413	OLEWOLFF ELEKTRONIK GmbH Schulstrasse 15A. DE-25451 Quickborn. Germany TEL: +49 (0) 4106 765900 FAX: +49 (0) 4106 627297	OLEWOLFF ELECTRONICS 3 Bedford Street, Woburn, Bedfordshire MK17 9QB, ENGLAND TEL: +44 (0) 1525 290755 FAX: +44 (0) 1525 290855	OLE WOLFF ELEKTRONIK Yliopistonkatu 26 (P.O.BOX 257) FI-40101 Jyväskylä Finland TEL: +358 14 338 3050 FAX: +358 14 338 3059	OLE WOLFF (ASIA) LTD. Unit B, 19/F, Bold Win Ind. Bldg., No. 16-18 Wah Sing St., Kwai Chung, N.T., H.K. TEL: +852 2424 3274 FAX: +852 2424 2219	OLE WOLFF LTD. 5 Floor, Block G, WenTao Industrial Park, YingRenShi, Bao'an District, Shenzhen, PRC TEL: +86 755 82612542 TEL: +86 755 26406156
---	---	--	---	--	---	---

	Date	01-Dec-2022	SPECIFICATION	OLE WOLFF
	Page	2 / 8		www.owolff.com
	DK	P/N: OWS-111535W50A-8		Revision: 00

1. SCOPE

THIS SPECIFICATION IS APPLIED FOR A DYNAMIC SPEAKER.

2. TEST CONDITIONS

TEMPERATURE : 15°C ~ 35°C

HUMIDITY : 45%~85% (R.H.)

ATMOSPHERE : 860 ~ 1060 hPa

3. GENERAL REQUIREMENTS

OPERATING TEMPERATURE RANGE: -20° C ~ 70° C

STORAGE TEMPERATUR RANGE: -40° C ~ 85° C

4. MECANICAL LAYOUT & DIMENSIONS

DIMENSIONS : SHOWN IN FIGURE.4

NET WEIGHT: approx 1.85g

5. ELECTRICAL AND ACOUSTICAL CHARACTERISTICS

1	IMPEDANCE	$8 \pm 15\% \Omega$
2	SOUND PRESSURE LEVEL	99±3 dB(1W/10cm, in 1cc box) at 0.8,1.0,1.5,2.0KHz average, MEASUREMENT AS SHOWN IN FIGURE.1
3	FREQUENCY RESPONSE CURVE	SHOW IN FIGURE 2
4	RESONANCE FREQUENCY	1000 ±20% Hz in 1cc box at 2.83Vrms
5	TOTAL HARMONIC DISTORTION (THD)	SHOW IN FIGURE 3 < 5% at 1KHz
6	BUZZ & RATTLE	DYNAMIC SPEAKER MUST BE FREE AUDIBLE NOISE AT 2.83Vrms, SINE WAVE BETWEEN 200Hz AND 2KHz FREQUENCY RANGE(in 1cc box).
7	INPUT POWER	(Nom./Max.): 1 W / 1.3W

OLE WOLFF ELEKTRONIK A/S Roedengvej 25 4180 Soroe Denmark TEL: +45 57833830 FAX: +45 57820019	OLE WOLFF ELECTRONICS INC. 1525 McCarthy Blvd, Suite 1093 Milpitas, Ca 95035 USA TEL: +1 408 888 8413	OLEWOLFF ELEKTRONIK GmbH Schulstrasse 15A. DE-25451 Quickborn. Germany TEL: +49 (0) 4106 765900 FAX: +49 (0) 4106 627297	OLEWOLFF ELECTRONICS 3 Bedford Street, Woburn, Bedfordshire MK17 9QB, ENGLAND TEL: +44 (0) 1525 290755 FAX: +44 (0) 1525 290855	OLE WOLFF ELEKTRONIK Yliopistonkatu 26 (P.O.BOX 257) FI-40101 Jyväskylä Finland TEL: +358 14 338 3050 FAX: +358 14 338 3059	OLE WOLFF (ASIA) LTD. Unit B, 19/F, Bold Win Ind. Bldg., No. 16-18 Wah Sing St., Kwai Chung, N.T., H.K. TEL: +852 2424 3274 FAX: +852 2424 2219	OLE WOLFF LTD. 5 Floor, Block G, WenTao Industrial Park, YingRenShi, Bao'an District, Shenzhen, PRC TEL: +86 755 82612542 TEL: +86 755 26406156
---	---	--	---	--	---	---

	Date	01-Dec-2022	SPECIFICATION	OLE WOLFF
	Page	3 / 8		www.owolff.com
	DK	P/N: OWS-111535W50A-8		Revision: 00

6. RELIABILITY TEST REQUIREMENTS.

After any following tests the S.P.L should not deviate more than $\pm 3\text{dB}$ from initial value.

No.	ITEMS	TEST CONDITION
1.	High temp. Test	Temperature: $+70\text{ }^{\circ}\text{C} \pm 3^{\circ}\text{C}$ Duration: 96 hours
2.	Low temp. Test	Temperature: $-30\text{ }^{\circ}\text{C} \pm 3^{\circ}\text{C}$ Duration: 96 hours
3.	Humidity Test	Temperature: $+40\text{ }^{\circ}\text{C} \pm 3^{\circ}\text{C}$ Relative Humidity: 90-95% RH Duration: 96 hours (recovery 6 hours)
4.	Thermal cycle test.	Low temperature: $-30\text{ }^{\circ}\text{C} \pm 3\text{ }^{\circ}\text{C}$, temperature: $+70\text{ }^{\circ}\text{C} \pm 3^{\circ}\text{C}$, cycle: 1 hour/cycle each, and then keep 10 cycles in a room.
5.	Vibration	10~55~10Hz sin-wave sweep 15min. 5G(constant) X, Y, Z 3 direction. 2 hours each, total 6 hours.
6.	Drop Test	Height: 1.5m Mounted in a 100g fixture, drop samples 1.5m 2 drops on side(2*6), , 2 drops on each corner(2*4). Total 20 drops
7.	Load test	Input power: 1W, White noise 96hours in 1cc box.
8.	Terminal Strength	Load: 1.0 Kg Duration: 15sec.(Shall be normal)

OLE WOLFF ELEKTRONIK A/S Roedengvej 25 4180 Soroe Denmark TEL: +45 57833830 FAX: +45 57820019	OLE WOLFF ELECTRONICS INC. 1525 McCarthy Blvd, Suite 1093 Milpitas, Ca 95035 USA TEL: +1 408 888 8413	OLEWOLFF ELEKTRONIK GmbH Schulstrasse 15A. DE-25451 Quickborn. Germany TEL: +49 (0) 4106 765900 FAX: +49 (0) 4106 627297	OLEWOLFF ELECTRONICS 3 Bedford Street, Woburn, Bedfordshire MK17 9QB, ENGLAND TEL: +44 (0) 1525 290755 FAX: +44 (0) 1525 290855	OLE WOLFF ELEKTRONIK Yliopistonkatu 26 (P.O.BOX 257) FI-40101 Jyväskylä Finland TEL: +358 14 338 3050 FAX: +358 14 338 3059	OLE WOLFF (ASIA) LTD. Unit B, 19/F, Bold Win Ind. Bldg., No. 16-18 Wah Sing St., Kwai Chung, N.T., H.K. TEL: +852 2424 3274 FAX: +852 2424 2219	OLE WOLFF LTD. 5 Floor, Block G, WenTao Industrial Park, YingRenShi, Bao'an District, Shenzhen, PRC TEL: +86 755 82612542 TEL: +86 755 26406156
---	---	--	---	--	---	---

	Date	01-Dec-2022	SPECIFICATION	OLE WOLFF
	Page	4 / 8		www.owolff.com
	DK	P/N: OWS-111535W50A-8		Revision: 00

7. ELECTRICAL CHARACTERISTICS MEASUREMENT (FIGURE.1)

MEASUREMENT CIRCUIT FOR DYNAMIC SPEAKER

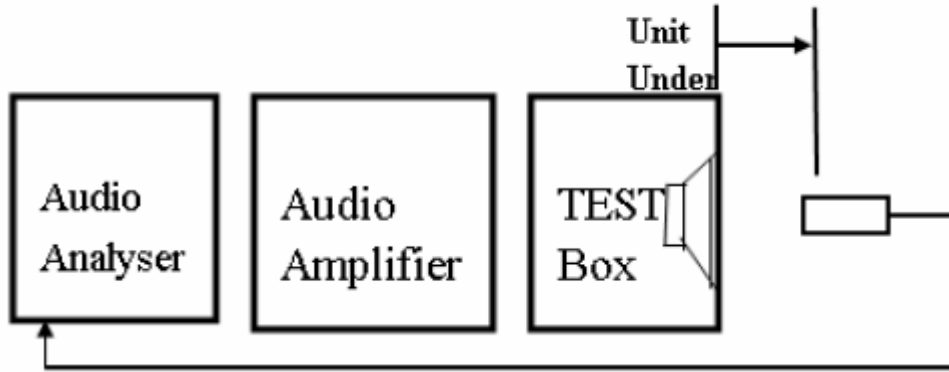

MEASURING EQUIPMENT

NO	EQUIPMENT	REMARKS
1.0	UNIT UNDER TEST	SPEAKER
2.0	TEST BOX	OLE WOLFF STANDARD BOX
3.0	AUDIO POWER AMPLIFIER	CRATE AUDIO SPA300
4.0	ANALYZER	LISTEN SOUNDCHECK

OLE WOLFF ELEKTRONIK A/S Roedengvej 25 4180 Soroe Denmark TEL: +45 57833830 FAX: +45 57820019	OLE WOLFF ELECTRONICS INC. 1525 McCarthy Blvd, Suite 1093 Milpitas, Ca 95035 USA TEL : +1 408 888 8413	OLEWOLFF ELEKTRONIK GmbH Schulstrasse 15A. DE-25451 Quickborn. Germany TEL: +49 (0) 4106 765900 FAX: +49 (0) 4106 627297	OLEWOLFF ELECTRONICS 3 Bedford Street, Woburn, Bedfordshire MK17 9QB, ENGLAND TEL: +44 (0) 1525 290755 FAX: +44 (0) 1525 290855	OLE WOLFF ELEKTRONIK Yliopistonkatu 26 (P.O.BOX 257) FI-40101 Jyväskylä Finland TEL: +358 14 338 3050 FAX: +358 14 338 3059	OLE WOLFF (ASIA) LTD. Unit B, 19/F, Bold Win Ind. Bldg., No. 16-18 Wah Sing St., Kwai Chung, N.T., H.K. TEL: +852 2424 3274 FAX: +852 2424 2219	OLE WOLFF LTD. 5 Floor, Block G, WenTao Industrial Park, YingRenShi, Bao'an District, Shenzhen , PRC TEL: +86 755 82612542 TEL: +86 755 26406156
---	--	--	---	--	---	--

	Date	01-Dec-2022	SPECIFICATION	OLE WOLFF
	Page	5 / 8		www.owolff.com
	DK	P/N: OWS-111535W50A-8		Revision: 00

8. STANDARD FREQUENCY RESPONSE CURVE(FIGURE.2)
2.83Vrms /10cm in 1cc BOX

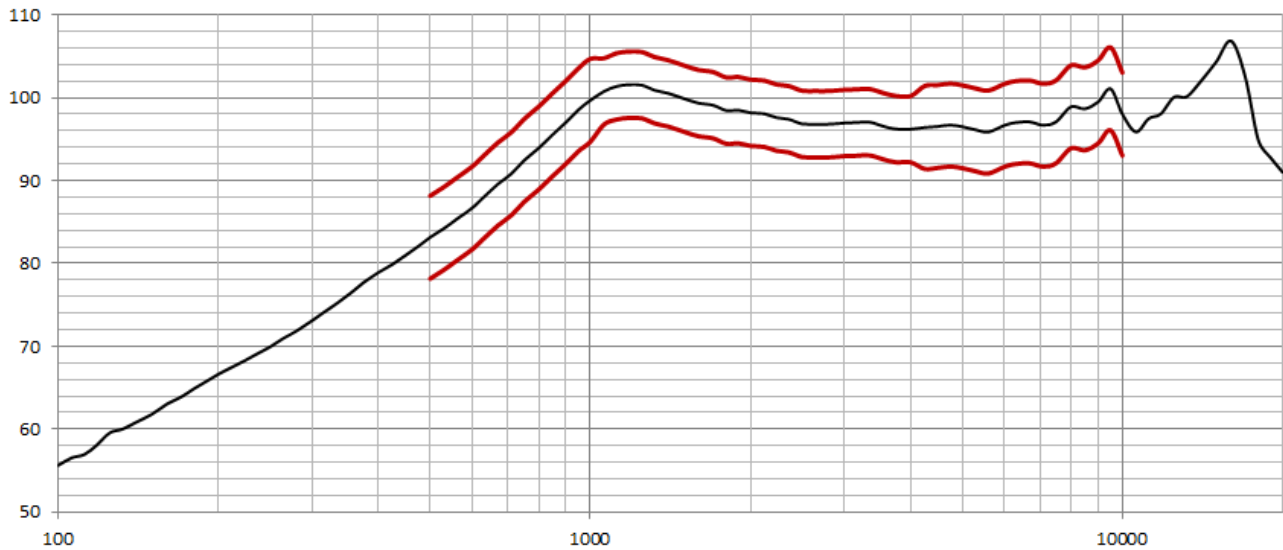

Hz	500~1000	1060~4000	4250~10000
dB	±5	±4	±5

9. STANDARD THD CURVE (FIGURE.3)
2.83Vrms /10cm in 1cc BOX

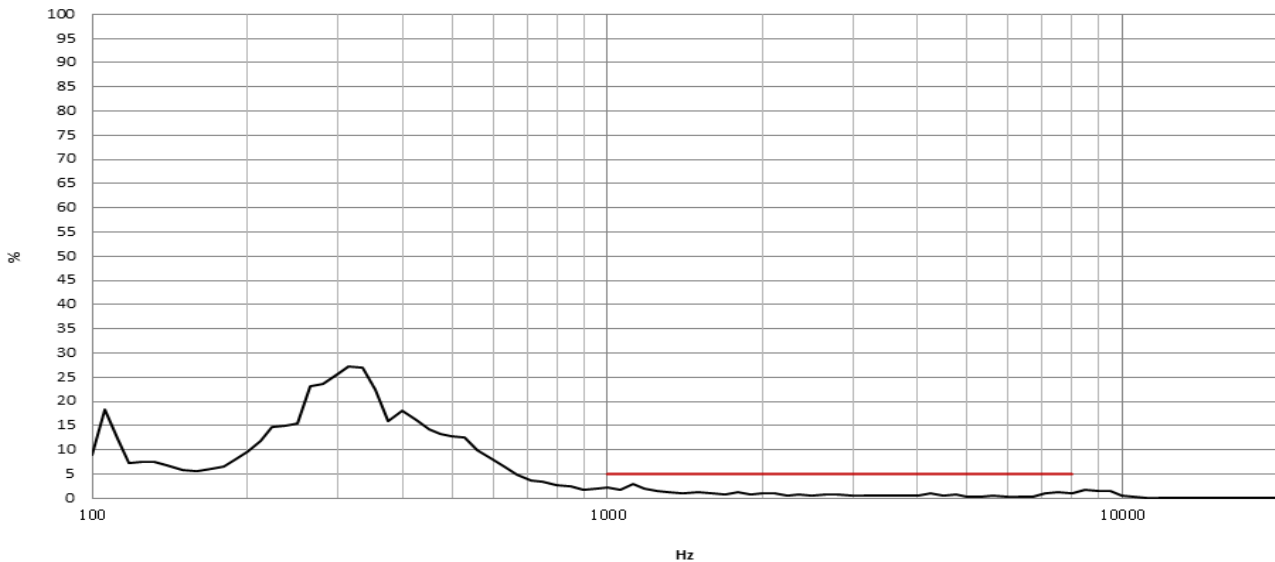

Hz	1000	8000
THD	5	5

OLE WOLFF ELEKTRONIK A/S Roedengvej 25 4180 Soroe Denmark TEL: +45 57833830 FAX: +45 57820019	OLE WOLFF ELECTRONICS INC. 1525 McCarthy Blvd, Suite 1093 Milpitas, Ca 95035 USA TEL: +1 408 888 8413	OLEWOLFF ELEKTRONIK GmbH Schulstrasse 15A. DE-25451 Quickborn. Germany TEL: +49 (0) 4106 765900 FAX: +49 (0) 4106 627297	OLEWOLFF ELECTRONICS 3 Bedford Street, Woburn, Bedfordshire MK17 9QB, ENGLAND TEL: +44 (0) 1525 290755 FAX: +44 (0) 1525 290855	OLE WOLFF ELEKTRONIK Yliopistonkatu 26 (P.O.BOX 257) FI-40101 Jyväskylä Finland TEL: +358 14 338 3050 FAX: +358 14 338 3059	OLE WOLFF (ASIA) LTD. Unit B, 19/F, Bold Win Ind. Bldg., No. 16-18 Wah Sing St., Kwai Chung, N.T., H.K. TEL: +852 2424 3274 FAX: +852 2424 2219	OLE WOLFF LTD. 5 Floor, Block G, WenTao Industrial Park, YingRenShi, Bao'an District, Shenzhen, PRC TEL: +86 755 82612542 TEL: +86 755 26406156
---	---	--	---	--	---	---

	Date	01-Dec-2022	SPECIFICATION	OLE WOLFF
	Page	6 / 8		www.owolff.com
	DK	P/N: OWS-111535W50A-8		Revision: 00

10. OUTVIEW (FIGURE.4)

Unless otherwise specified, tolerance: ± 0.2 (unit: mm)

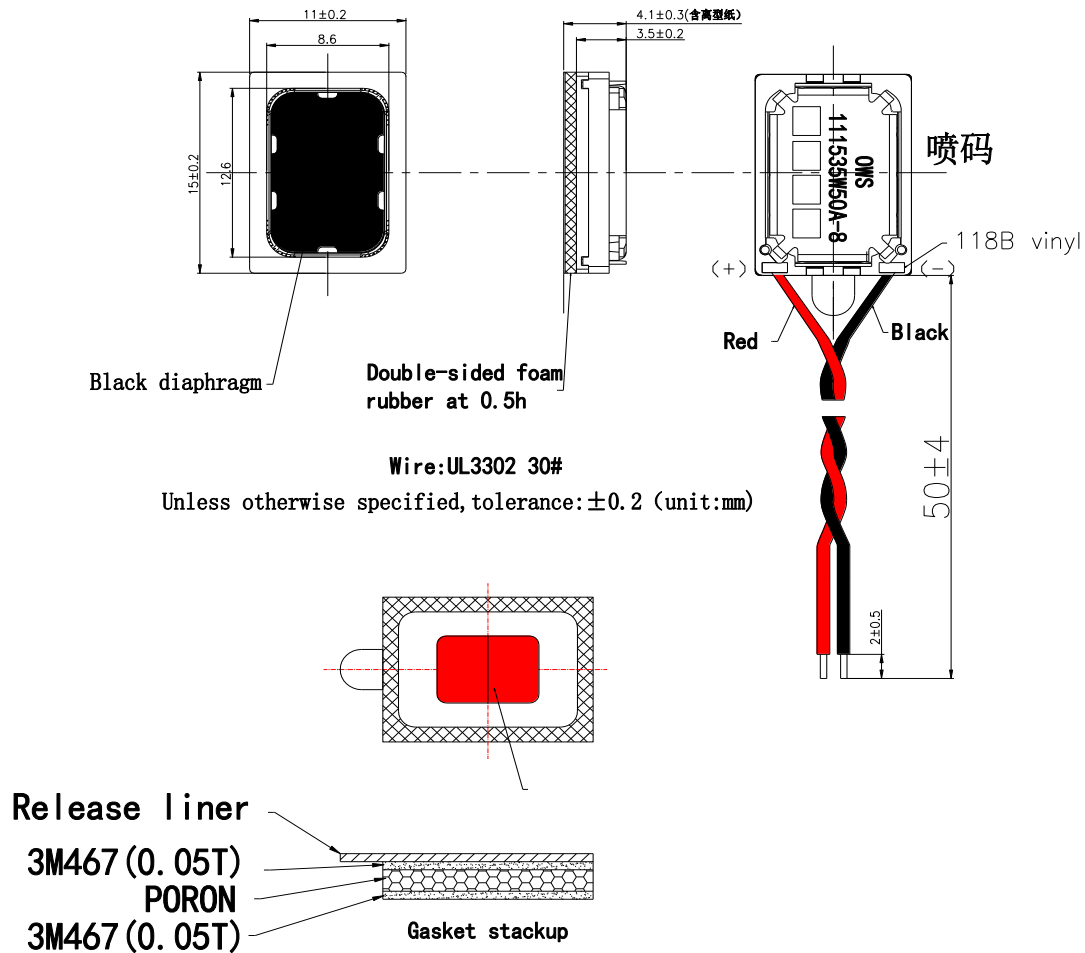

OLE WOLFF ELEKTRONIK A/S Roedengvej 25 4180 Soroe Denmark TEL: +45 57833830 FAX: +45 57820019	OLE WOLFF ELECTRONICS INC. 1525 McCarthy Blvd, Suite 1093 Milpitas, Ca 95035 USA TEL: +1 408 888 8413	OLEWOLFF ELEKTRONIK GmbH Schulstrasse 15A. DE-25451 Quickborn, Germany TEL: +49 (0) 4106 765900 FAX: +49 (0) 4106 627297	OLEWOLFF ELECTRONICS 3 Bedford Street, Woburn, Bedfordshire MK17 9QB, ENGLAND TEL: +44 (0) 1525 290755 FAX: +44 (0) 1525 290855	OLE WOLFF ELEKTRONIK Yliopistonkatu 26 (P.O.BOX 257) FI-40101 Jyväskylä Finland TEL: +358 14 338 3050 FAX: +358 14 338 3059	OLE WOLFF (ASIA) LTD. Unit B, 19/F, Bold Win Ind. Bldg., No. 16-18 Wah Sing St., Kwai Chung, N.T., H.K. TEL: +852 2424 3274 FAX: +852 2424 2219	OLE WOLFF LTD. 5 Floor, Block G, WenTao Industrial Park, YingRenShi, Bao'an District, Shenzhen, PRC TEL: +86 755 82612542 TEL: +86 755 26406156
---	---	--	---	--	---	---

	Date	01-Dec-2022	SPECIFICATION	OLE WOLFF	
	Page	7 / 8		www.owolff.com	
	DK	P/N: OWS-111535W50A-8		Revision: 00	

11. MARKING(FIGURE.5)

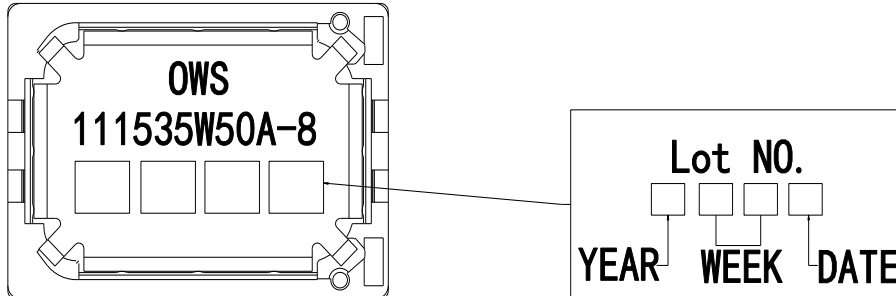

Y (YEAR)		WW (WEEK)		D (DATE)	
year	marking	week	marking	date	marking
2019	9	1	01	MON	1
2020	0	↓	↓	TUE	2
2021	1			WED	3
2022	2			THU	4
2023	3	50	50	FRI	5
		51	51	SAT	6
		52	52	SUN	7
		53	53		

OLE WOLFF ELEKTRONIK A/S Roedengvej 25 4180 Soroe Denmark TEL: +45 57833830 FAX: +45 57820019	OLE WOLFF ELECTRONICS INC. 1525 McCarthy Blvd, Suite 1093 Milpitas, Ca 95035 USA TEL: +1 408 888 8413	OLEWOLFF ELEKTRONIK GmbH Schulstrasse 15A. DE-25451 Quickborn. Germany TEL: +49 (0) 4106 765900 FAX: +49 (0) 4106 627297	OLEWOLFF ELECTRONICS 3 Bedford Street, Woburn, Bedfordshire MK17 9QB, ENGLAND TEL: +44 (0) 1525 290755 FAX: +44 (0) 1525 290855	OLE WOLFF ELEKTRONIK Yliopistonkatu 26 (P.O.BOX 257) FI-40101 Jyväskylä Finland TEL: +358 14 338 3050 FAX: +358 14 338 3059	OLE WOLFF (ASIA) LTD. Unit B, 19/F, Bold Win Ind. Bldg., No. 16-18 Wah Sing St., Kwai Chung, N.T., H.K. TEL: +852 2424 3274 FAX: +852 2424 2219	OLE WOLFF LTD. 5 Floor, Block G, WenTao Industrial Park, YingRenShi, Bao'an District, Shenzhen, PRC TEL: +86 755 82612542 TEL: +86 755 26406156
---	---	--	---	--	---	---

	Date	01-Dec-2022	SPECIFICATION	OLE WOLFF
	Page	8 / 8		www.owolff.com
	DK	P/N: OWS-111535W50A-8	Revision: 00	

12. PACKING(Figure.6)

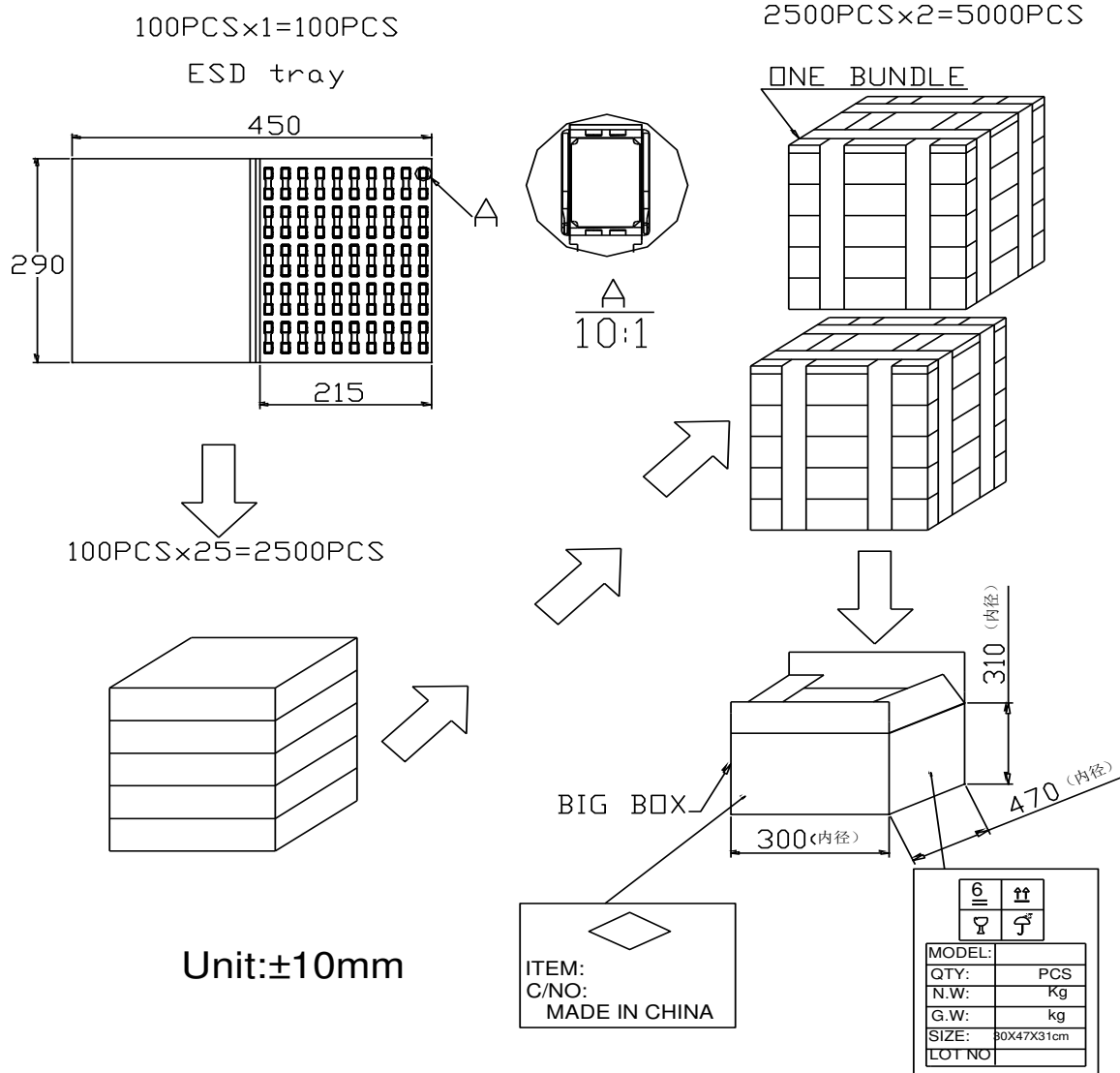

OLE WOLFF ELEKTRONIK A/S Roedengvej 25 4180 Soroe Denmark TEL: +45 57833830 FAX: +45 57820019	OLE WOLFF ELECTRONICS INC. 1525 McCarthy Blvd, Suite 1093 Milpitas, Ca 95035 USA TEL: +1 408 888 8413	OLEWOLFF ELEKTRONIK GmbH Schulstrasse 15A. DE-25451 Quickborn. Germany TEL: +49 (0) 4106 765900 FAX: +49 (0) 4106 627297	OLEWOLFF ELECTRONICS 3 Bedford Street, Woburn, Bedfordshire MK17 9QB, ENGLAND TEL: +44 (0) 1525 290755 FAX: +44 (0) 1525 290855	OLE WOLFF ELEKTRONIK Yliopistonkatu 26 (P.O.BOX 257) FI-40101 Jyväskylä Finland TEL: +358 14 338 3050 FAX: +358 14 338 3059	OLE WOLFF (ASIA) LTD. Unit B, 19/F, Bold Win Ind. Bldg., No. 16-18 Wah Sing St., Kwai Chung, N.T., H.K. TEL: +852 2424 3274 FAX: +852 2424 2219	OLE WOLFF LTD. 5 Floor, Block G, WenTao Industrial Park, YingRenShi, Bao'an District, Shenzhen, PRC TEL: +86 755 82612542 TEL: +86 755 26406156
---	---	--	---	--	---	---