

Low Dropout Voltage Regulator

■ GENERAL DESCRIPTION

The NJM2871B/72B are low dropout voltage regulator designed for cellular phone applications.

Advanced Bipolar technology achieves low noise, high ripple rejection and low quiescent current.

■ PACKAGE OUTLINE

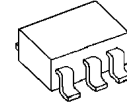

NJM2871BF/72BF

■ FEATURES

- High Ripple Rejection 75dB typ. (f=1kHz Vo=3V version)
- Output Noise Voltage Vno=30μVrms typ. (Cp=0.01μF)
- Output capacitor with 1.0uF ceramic capacitor (Vo≥2.7V: Version)
- Output Current Io(max.)=150mA
- High Precision Output Vo ±1.0%
- Low Dropout Voltage 0.10V typ. (Io=60mA)
- Input Voltage Range +2.3 ~ +14V (Vo≤2.0V version)
- ON/OFF Control (Active High)
- Internal Short Circuit Current Limit
- Internal Thermal Overload Protection
- Bipolar Technology
- Package Outline SOT-23-5 (MTP5)

■ PIN CONFIGURATION

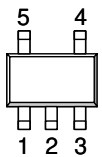

1. CONTROL (Active High)
2. GND
3. NOISE BYPASS
4. V_{OUT}
5. V_{IN}

NJM2871BF

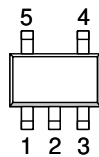

1. V_{IN}
2. GND
3. CONTROL (Active High)
4. NOISE BYPASS
5. V_{OUT}

NJM2872BF

■ EQUIVALENT CIRCUIT

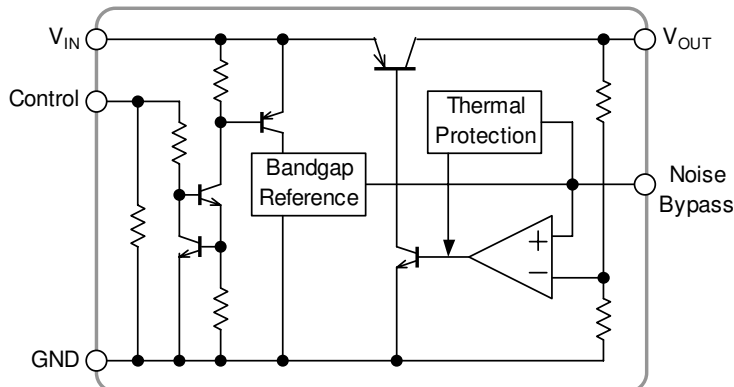

NJM2871B/72B

■ OUTPUT VOLTAGE RANK LIST

Device Name	V _{OUT}	Device Name	V _{OUT}	Device Name	V _{OUT}
NJM287*BF15	1.5V	NJM287*BF26	2.6V	NJM287*BF34	3.4V
NJM287*BF18	1.8V	NJM287*BF27	2.7V	NJM287*BF35	3.5V
NJM287*BF19	1.9V	NJM287*BF28	2.8V	NJM287*BF38	3.8V
NJM287*BF02	2.0V	NJM287*BF29	2.9V	NJM287*BF04	4.0V
NJM287*BF21	2.1V	NJM287*BF03	3.0V	NJM287*BF48	4.8V
NJM287*BF23	2.3V	NJM287*BF31	3.1V	NJM287*BF05	5.0V
NJM287*BF24	2.4V	NJM287*BF32	3.2V		
NJM287*BF25	2.5V	NJM287*BF33	3.3V		

■ ABSOLUTE MAXIMUM RATINGS

(Ta=25°C)

PARAMETER	SYMBOL	RATINGS	UNIT	
Input Voltage	V _{IN}	+14	V	
Control Voltage	V _{CONT}	+14(*1)	V	
Power Dissipation	P _D	SOT-23-5	350(*2)	mW
			200(*3)	
Operating Temperature	T _{opr}	-40 ~ +85	°C	
Storage Temperature	T _{stg}	-40 ~ +125	°C	

(*1) : When input voltage is less than +14V, the absolute maximum control voltage is equal to the input voltage.

(*2) : Mounted on glass epoxy board based on EIA/JEDEC. (114.3x76.2x1.6mm: 2Layers)

(*3) : Device itself

■ Operating voltage

V_{IN}=+2.3 ~ +14V (In case of Vo<2.1V version)

■ ELECTRICAL CHARACTERISTICS

(V_{IN}=Vo+1V, C_{IN}=0.1μF, Co=1.0μF: Vo≥2.7V (Co=2.2μF : 1.8V<Vo≤2.6V.; Co=4.7μF : Vo≤1.8V), Cp=0.01μF, Ta=25°C)

PARAMETER	SYMBOL	TEST CONDITION	MIN.	TYP.	MAX.	UNIT
Output Voltage	Vo	I _o =30mA	-1.0%	-	+1.0%	V
Quiescent Current	I _Q	I _o =0mA, except I _{cont}	-	120	180	μA
Quiescent Current at Control OFF	I _{Q(OFF)}	V _{CONT} =0V	-	-	100	nA
Output Current	I _o	Vo-0.3V	150	200	-	mA
Line Regulation	ΔVo/ΔV _{IN}	V _{IN} =Vo+1V ~ Vo+6V, I _o =30mA	-	-	0.10	%/V
Load Regulation	ΔVo/ΔI _o	I _o =0 ~ 100mA	-	-	0.03	%/mA
Dropout Voltage (*4)	ΔV _{LO}	I _o =60mA	-	0.10	0.18	V
Ripple Rejection	RR	e _{in} =200mVrms, f=1kHz, I _o =10mA, Vo=3V version	-	75	-	dB
Average Temperature Coefficient of Output Voltage	ΔVo/ΔTa	Ta=0 ~ +85°C, I _o =10mA	-	±50	-	ppm/°C
Output Noise Voltage	V _{NO1}	f=10Hz-80kHz, I _o =10mA, Vo=3V Version	-	30	-	μVrms
Control Voltage for ON-state	V _{CONT(ON)}		1.6	-	-	V
Control Voltage for OFF-state	V _{CONT(OFF)}		-	-	0.6	V

(*4): The output voltage excludes under 2.1V.

The above specification is a common specification for all output voltages.

Therefore, it may be different from the individual specification for a specific output voltage.

■ TEST CIRCUIT

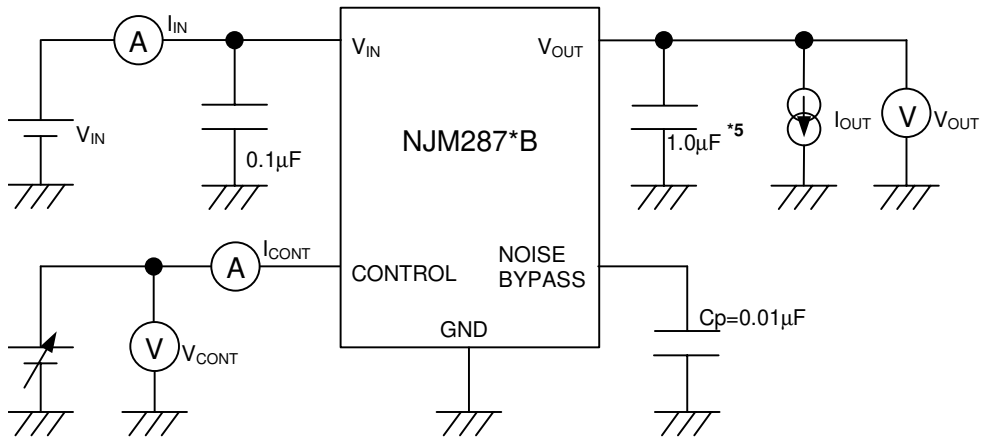

*5 1.8V < V_o ≤ 2.6V version : $C_o=2.2\mu\text{F}$
 $V_o \leq 1.8\text{V}$ version : $C_o=4.7\mu\text{F}$

NJM2871B/72B

■ TYPICAL APPLICATION

① In the case where ON/OFF Control is not required:

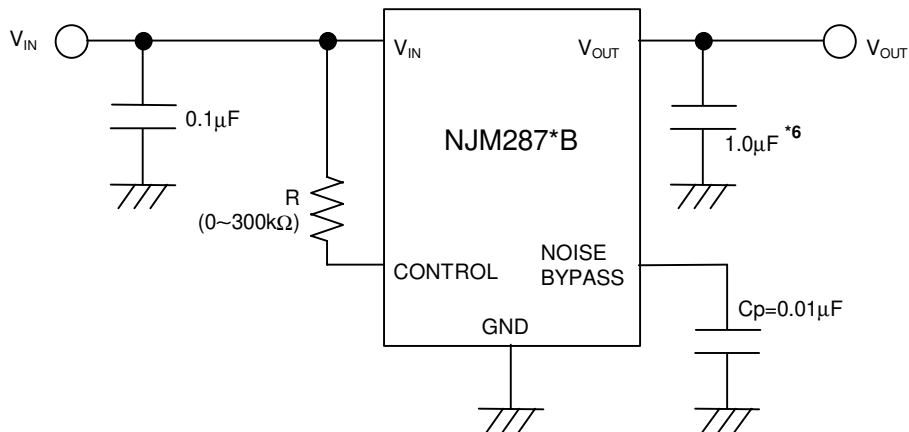

*6 1.8V $V_o \le 2.6V$ version : $C_o=2.2\mu F$
 $V_o \le 1.8V$ version : $C_o=4.7\mu F$

Connect control terminal to V_{IN} terminal

② In use of ON/OFF CONTROL:

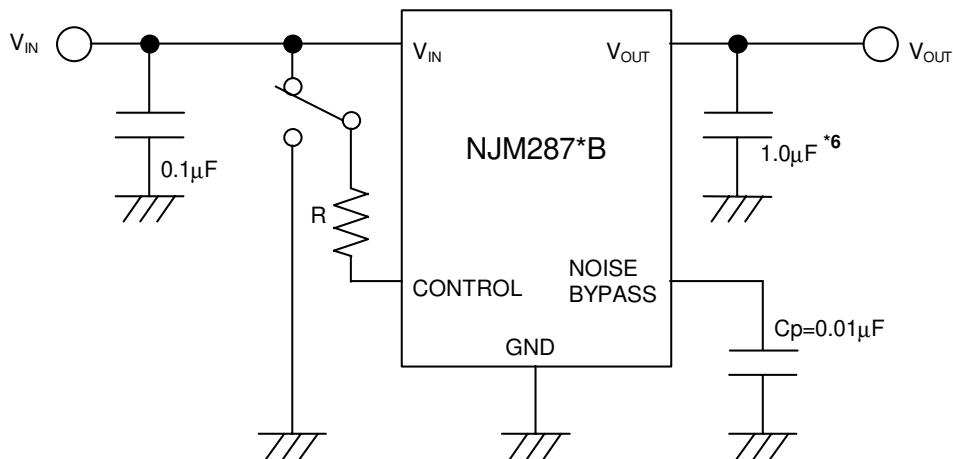

*6 1.8V $V_o \le 2.6V$ version : $C_o=2.2\mu F$ (ceramic)
 $V_o \le 1.8V$ version : $C_o=4.7\mu F$ (ceramic)

State of control terminal:

- "H" → output is enabled.
- "L" or "open" → output is disabled.

*Noise bypass Capacitance C_p

Noise bypass capacitance C_p reduces noise generated by band-gap reference circuit. Noise level and ripple rejection will be improved when larger C_p is used. Use of smaller C_p value may cause oscillation. Use the C_p value of $0.01\mu F$ greater to avoid the problem.

*In the case of using a resistance "R" between V_{IN} and control.

The current flow into the control terminal while the IC is ON state (I_{CONT}) can be reduced when a pull up resistance "R" is inserted between V_{IN} and the control terminal. The minimum control voltage for ON state ($V_{CONT(ON)}$) is increased due to the voltage drop caused by I_{CONT} and the resistance "R". The I_{CONT} is temperature dependence as shown in the "Control Current vs. Temperature" characteristics. Therefore, the resistance "R" should be carefully selected to ensure the control voltage exceeds the $V_{CONT(ON)}$ over the required temperature range.

■ POWER DISSIPATION vs. AMBIENT TEMPERATURE

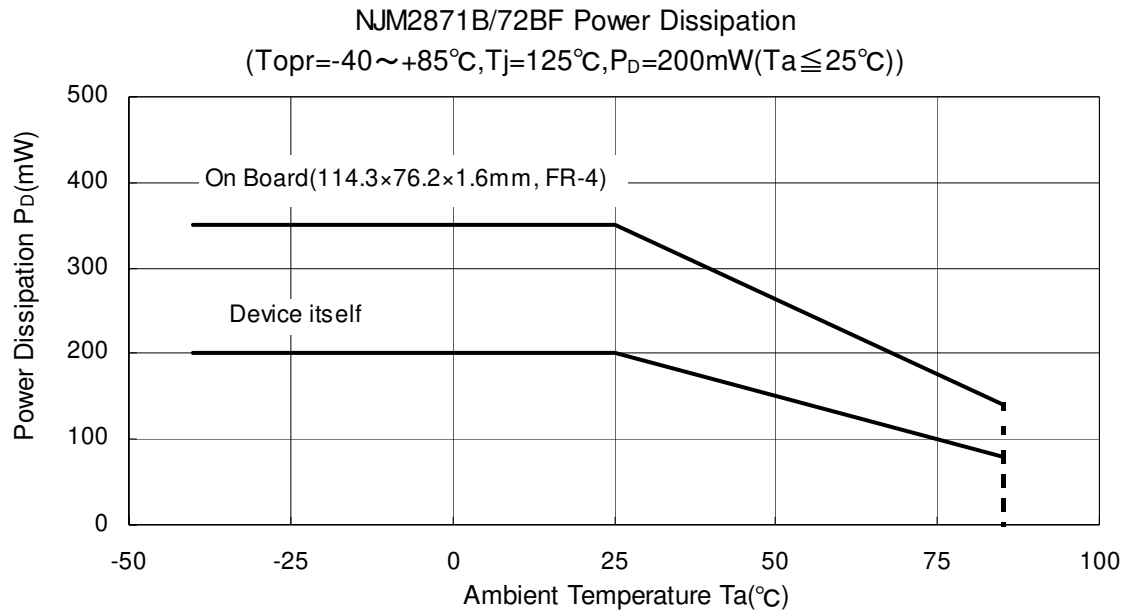

NJM2871B/72B

ELECTRICAL CHARACTERISTICS

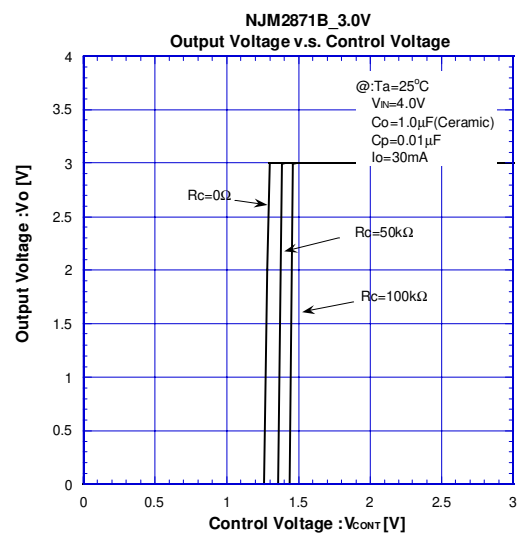
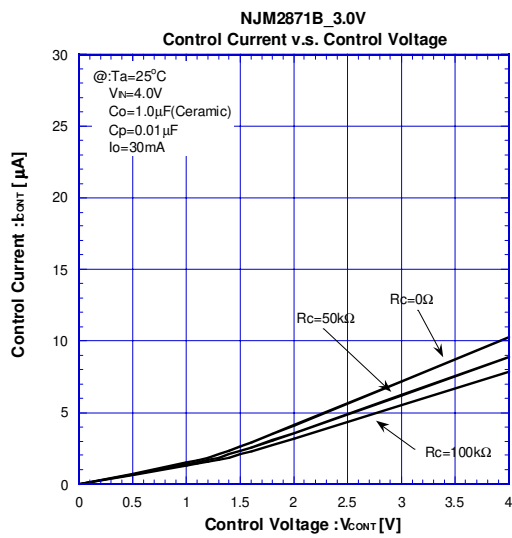
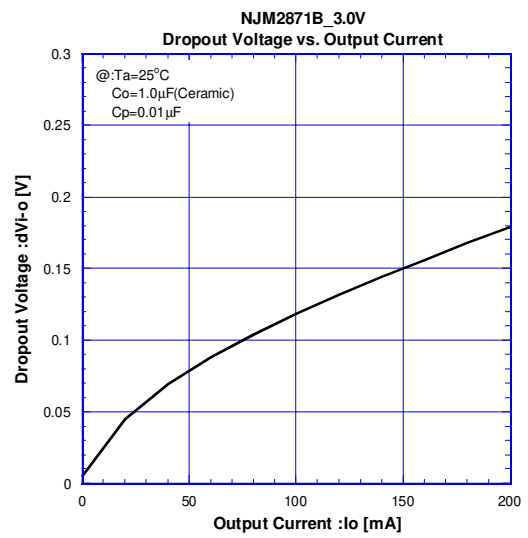
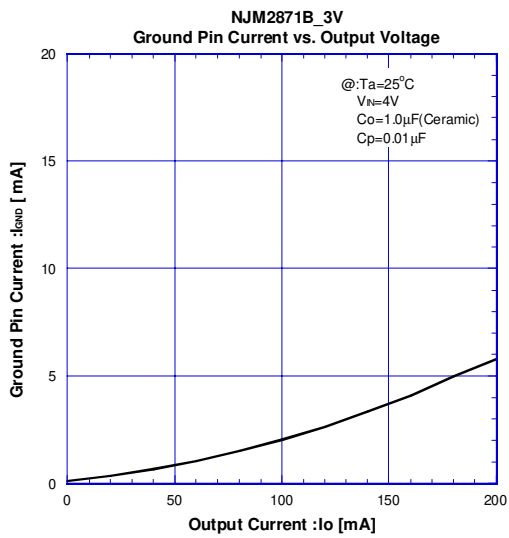
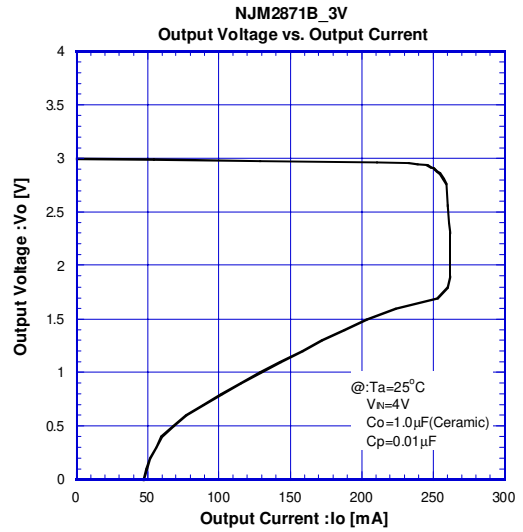
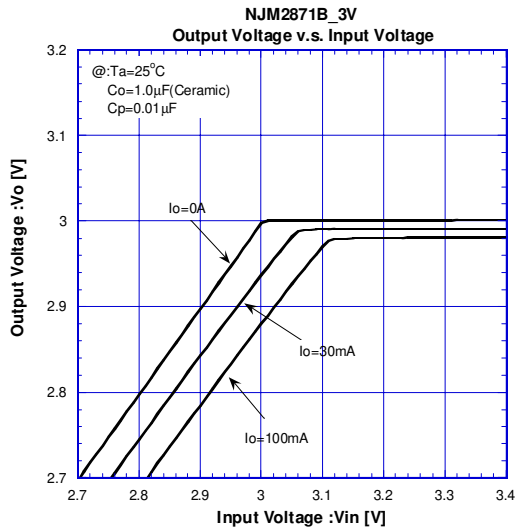

ELECTRICAL CHARACTERISTICS

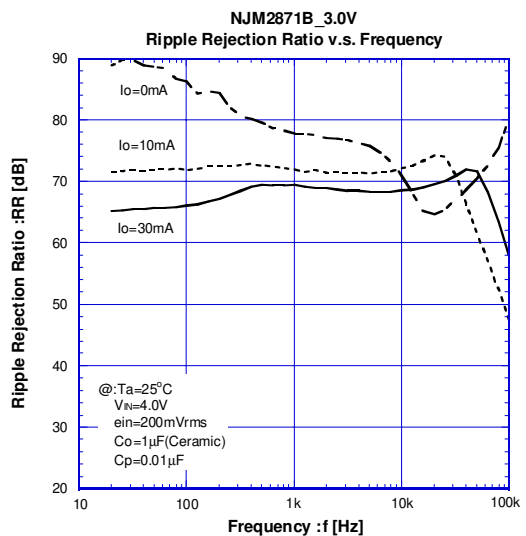
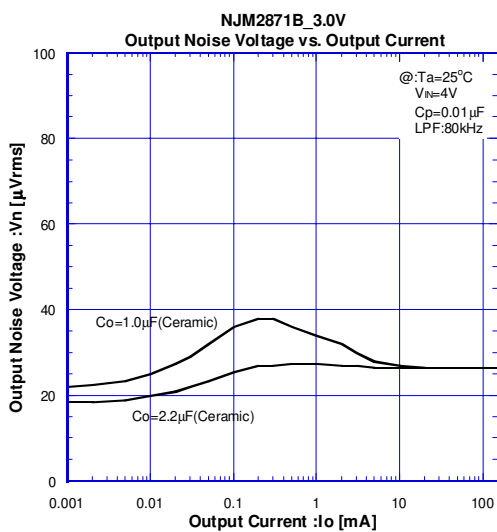
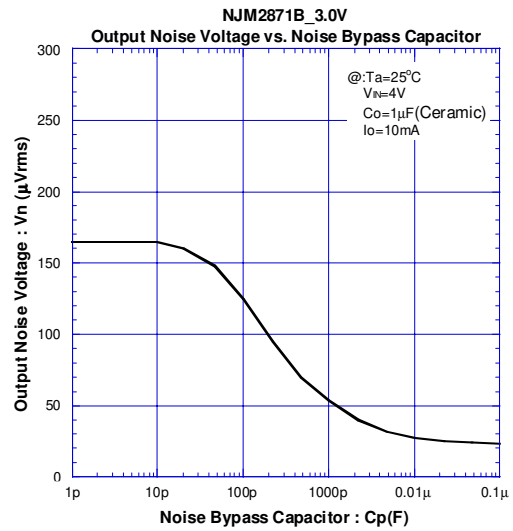
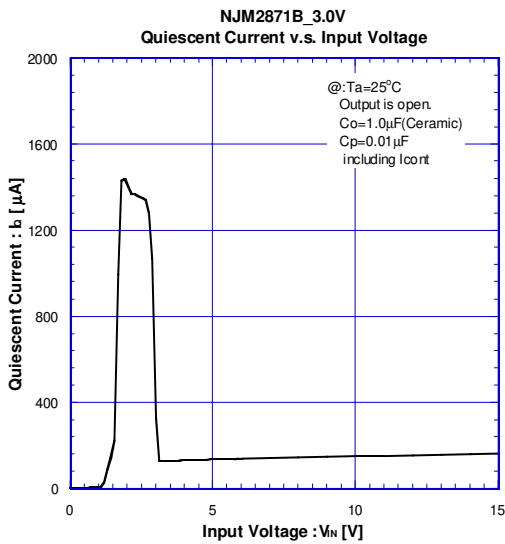
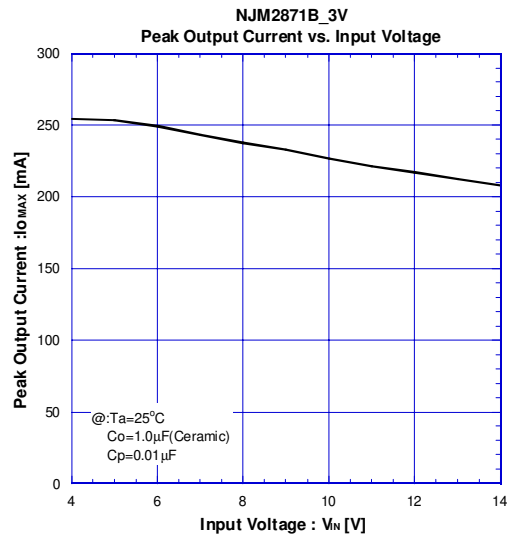
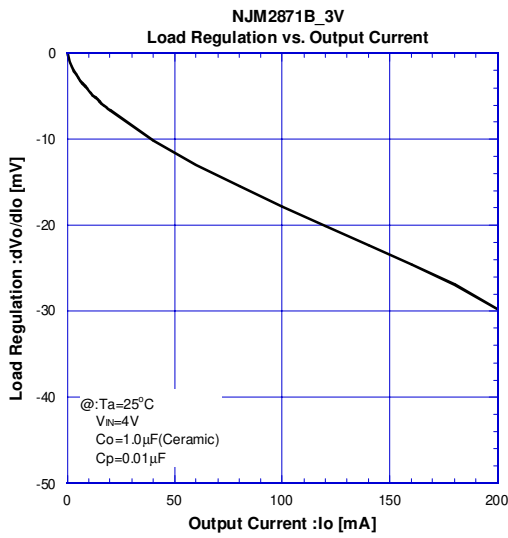

NJM2871B/72B

ELECTRICAL CHARACTERISTICS

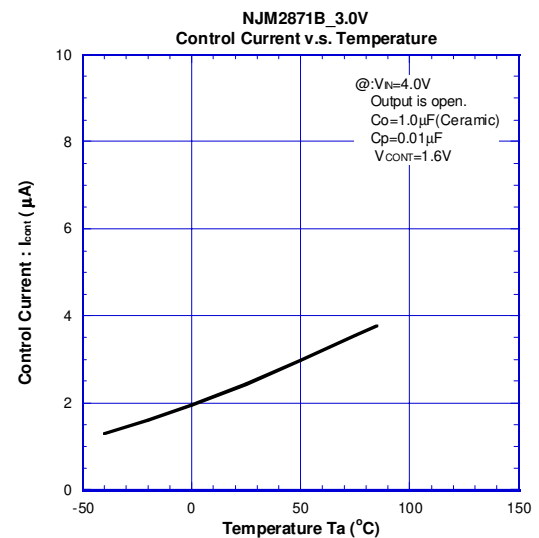
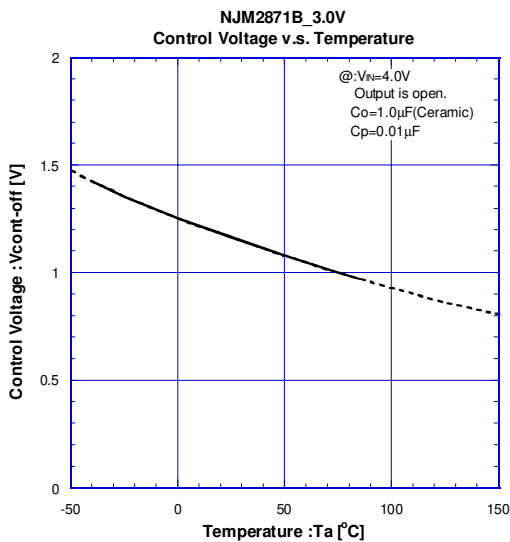
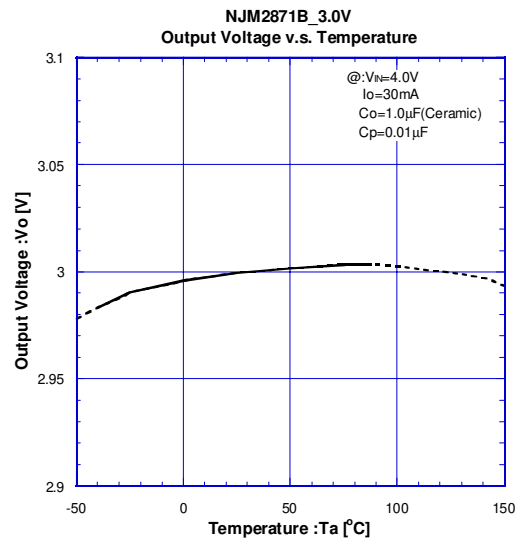
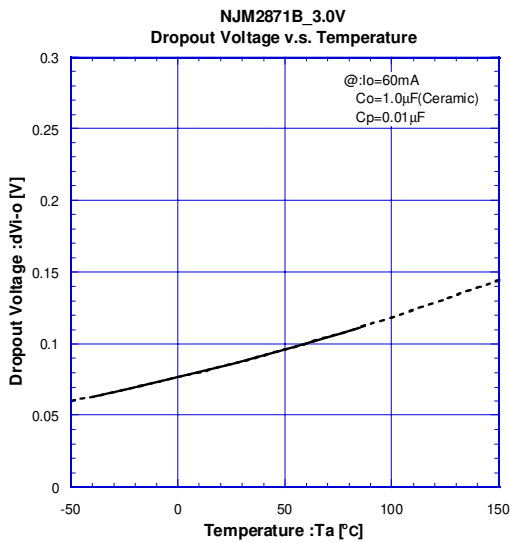
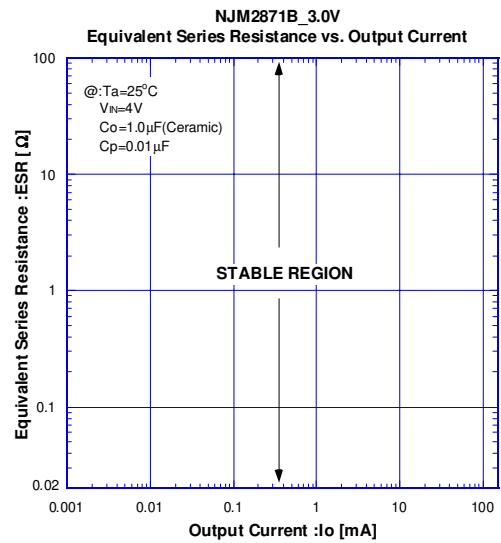
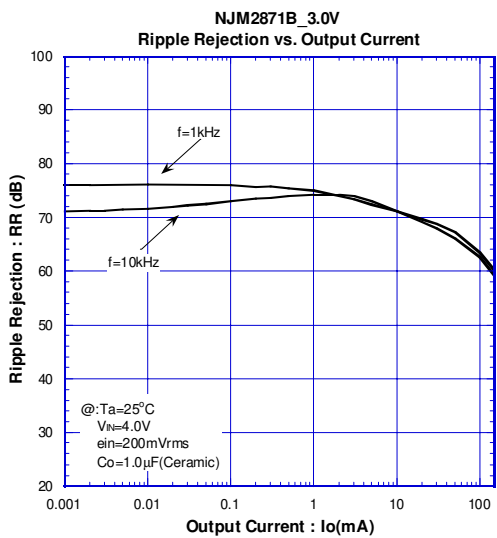

ELECTRICAL CHARACTERISTICS

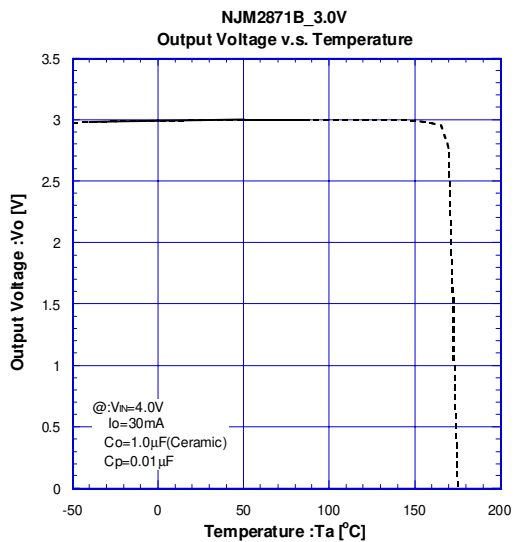
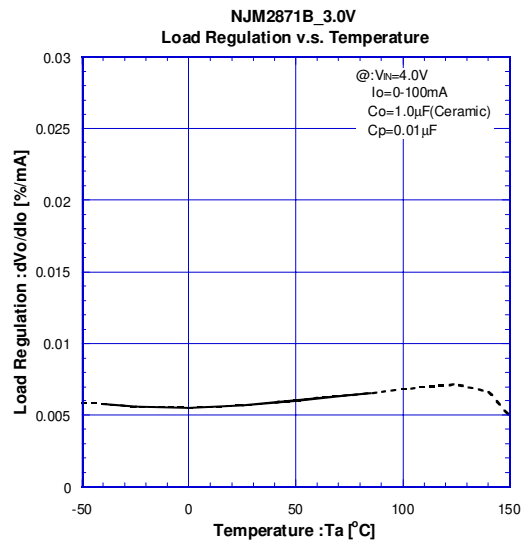
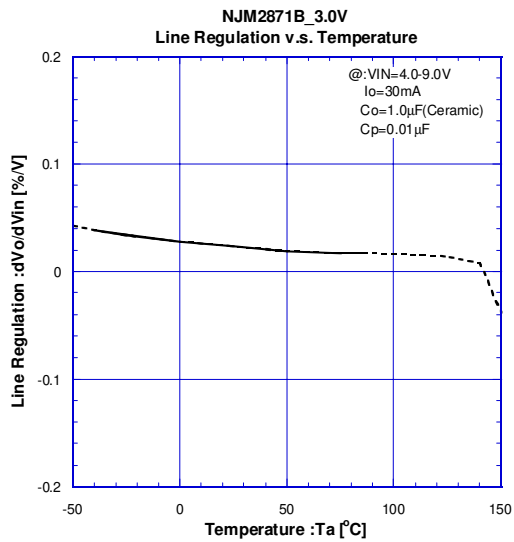
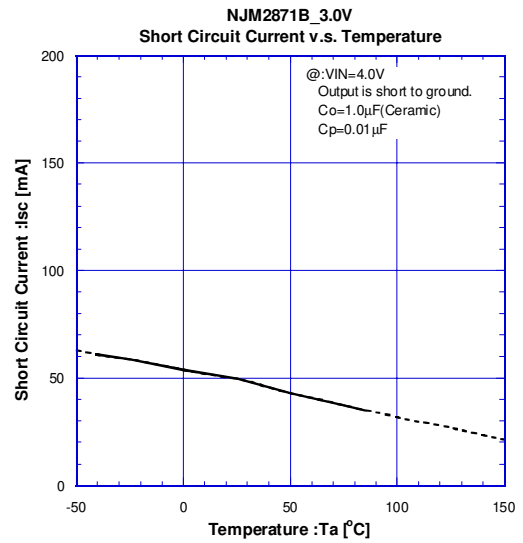
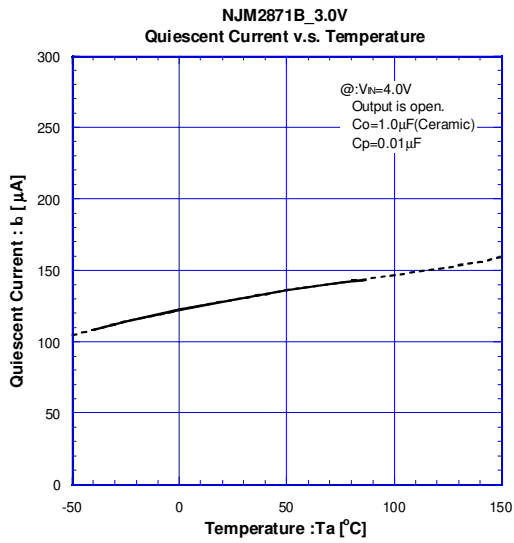

NJM2871B/72B

■ ELECTRICAL CHARACTERISTICS

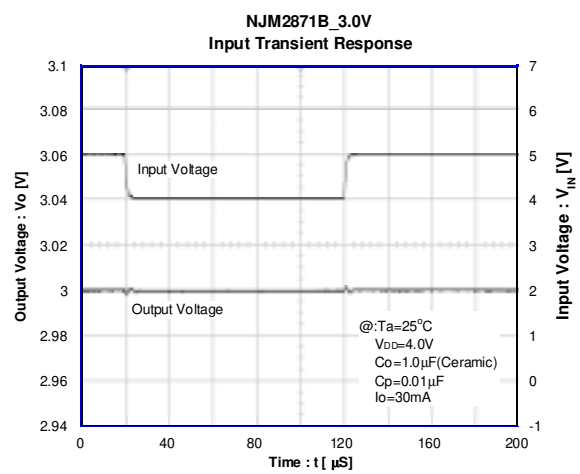
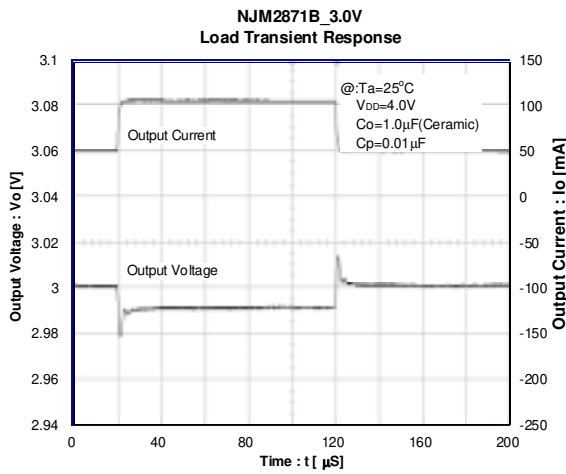
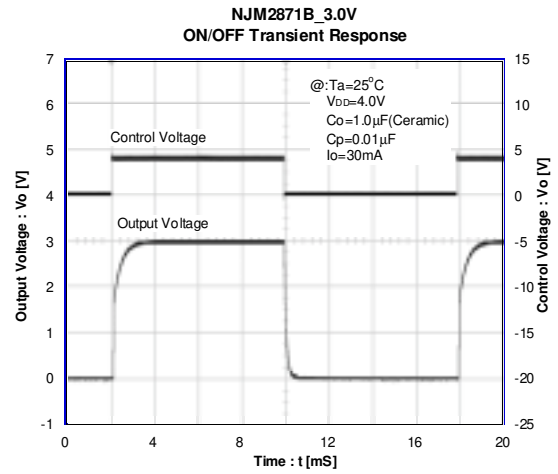
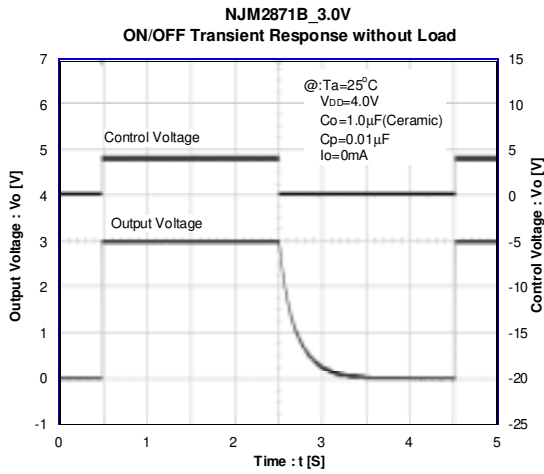

[CAUTION]
 The specifications on this databook are only given for information, without any guarantee as regards either mistakes or omissions. The application circuits in this databook are described only to show representative usages of the product and not intended for the guarantee or permission of any right including the industrial rights.