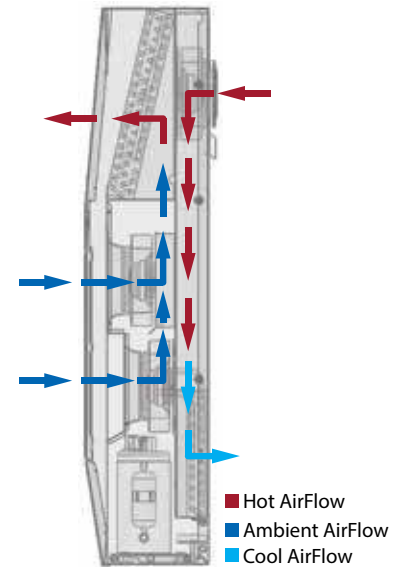
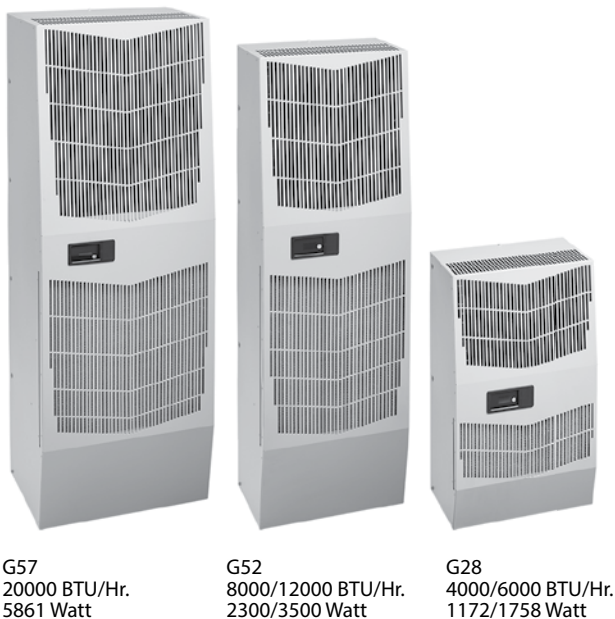

SPECTRACOOL INDOOR/OUTDOOR

INDUSTRY STANDARDS

UL/cUL Listed; Type 12, 3R, 4; 4X optional; File No. SA6453

CE
 EAC
 IP 56 Internal Loop
 IP 34 on External Loop
 Telcordia GR-487 capable*

*Partial Recess Mount units are not eligible for Type 4 or 4X ratings. Also not eligible for Telecoria GR-487 certification.

APPLICATION

- Industrial automation
- Telecommunications equipment
- Waste water treatment systems
- Package handling equipment
- Security and defense systems
- And more

FEATURES

- Energy-efficient rotary compressor on most models
- R407c and R134a refrigerants
- 115, 230 and 400/460 VAC 3-phase power input on most models
- UL Listed to save customers time and money with agency approvals
- Exterior and partially recessed mounting options
- Attractive industrial design with minimal use of visible fasteners
- Reliable mechanical thermostat on enclosure side of the unit
- All G-series come standard with two separate thermostats for cooling and heating when a heater is equipped
- Dual condenser-side air movers for performance redundancy on G52 and G57 models
- Galvanized or stainless steel cover for rugged factory and outdoor environments
- Easy-mount flanges for simple installation

- Cutout Adapter options for enclosures with older nVent HOFFMAN or Competitive units for easy transitions to new air conditioners
- Dust-resistant condenser coil allows the unit to be run filterless in most indoor applications
- Cleanable, reusable aluminum mesh filter included to protect coils for maximum cooling performance in dirty environments
- Mounting hardware, gaskets and user manual furnished with the unit
- Every unit functionally tested before shipping
- Standard Indoor Air Conditioner models also include:
 - Active condensate management with heater strip
 - Power-off relay for door switch and other system requirements
 - Malfunction switch
 - Indoor air conditioner models include digital display on ambient side
- Standard Outdoor Air Conditioner models also include:
 - Telcordia GR-487 capable*
 - Corrosion-resistant coatings on condenser coil for Type 4 units and on condenser coil and ambient-side copper joints for 4X units
 - Malfunction switch
 - Compressor heater
 - Head pressure control
 - All standard G28/G52 units have 2000W, but smaller heaters are available for custom units
 - Outdoor model operating temperature range from -40 F/-40 C to 131 F/55 C
- Visit web address for more information regarding SpectraCool Remote Access Control (RAC)
<http://hoffman.nvent.com/en/hoffman/SPECTRACOOLRemote-Access-Control-472042>

FINISH

- RAL 7035 light-gray, semi-textured powder-coat paint
- Stainless steel models are Type 304
- Other colors and textures available

Performance Data **G28 Models 4000/6000 BTU/Hr. (1172/1758 Watt)**

CATALOG NUMBER						
Indoor Model	G280416G050	G280426G050	G280446G050	G280616G050	G280626G050	G280646G050
Indoor Model Stainless Steel Type 4X	G280416G051	G280426G051	G280446G051	G280616G051	G280626G051	G280646G051
Indoor Model with Remote Access Control*	G280416G060	G280426G060	G280446G060	G280616G060	G280626G060	G280646G060
Outdoor Model without Heat Pkg.	G280416G100	G280426G100	G280446G100	G280616G100	G280626G100	G280646G100
Outdoor Model Partial Recessed Mount**	G280416G101	G280426G101	G280446G101	G280616G101	G280626G101	G280646G101
Outdoor Model with Heat Pkg.	G280416G150	G280426G150	-	G280616G150	G280626G150	-
Outdoor Model with Heat Pkg. Stainless Steel Type 4X	G280416G151	G280426G151	-	G280616G151	G280626G151	-
COOLING PERFORMANCE						
Nominal:						
BTU/Hr.	4000	4600/4900	4600/4900	6000/6400	6000/6400	5400/6000
Watts	1172	1347/1435	1347/1435	1757/1874	1757/1874	1581/1757
At 131 F/131 F (55 C/55 C):						
BTU/Hr. (50/60 Hz)	3700	4600/4900	4600/4900	6000/6400	6000/6400	5400/6000
W (50/60 Hz)	1084	1347/1435	1347/1435	1757/1874	1757/1874	1581/1757
At 95 F/95 F (35 C/35 C):						
BTU/Hr. (50/60 Hz)	3300/3410	4300/4600	4324/4655	5600/6000	5600/6000	5054/5685
W (50/60 Hz)	967/1000	1260/1364	1267/1364	1641/1758	1641/1758	1481/1666
Refrigerant	R134A	R407C	R134A	R407C	R407C	R134A
Refrigerant Charge (ounces/grams)	12/340	20/567	16/454	20/567	20/567	16/454
Operating Temperature Range:						
Maximum (°F/°C)	131/55	131/55	131/55	131/55	131/55	131/55
Indoor Minimum (°F/°C)	50/10	50/10	50/10	50/10	50/10	50/10
Outdoor Minimum (°F/°C)	-40/-40	-40/-40	-40/-40	-40/-40	-40/-40	-40/-40
Air Flow at 0 Static Pressure:						
Internal loop 50 Hz (CFM / m ³ /hr.)	151/256	189/321	189/321	189/321	189/321	189/321
External loop 50 Hz (CFM / m ³ /hr.)	284/482	291/494	291/494	291/494	291/494	291/494
Internal loop 60 Hz (CFM / m ³ /hr.)	183/310	221/375	221/375	221/375	221/375	221/375
External loop 60 Hz (CFM / m ³ /hr.)	290/492	300/509	300/509	300/509	300/509	300/509
Max. Heater W (Outdoor Models)	2000	2000	NA	2000	2000	NA
ELECTRICAL DATA						
Rated Voltage	115	230	400/460 3~	115	230	400/460 3~
Frequency (Hz)	50/60	50/60	50/60	50/60	50/60	50/60
Operating Range	+/- 10%	+/- 10%	+/- 10%	+/- 10%	+/- 10%	+/- 10%
Max. Power Consumption (W at 50/60 Hz)	465/1055	1058/1334	985/1199	1138.5/1311	1058/1334	985/1199
Max. Nominal Current (A at 50/60 Hz)	10.4/10.1	4.6/5.8	1.7/1.9	9.9/11.4	4.6/5.8	1.7/1.9
Starting Current (A)	36.2	17.7	7.7	36.2	17.7	7.7
Agency Approvals	UL/cUL Listed CE EAC					
Power Input Description	Terminal Block					
ENCLOSURE PROTECTION						
UL Type	Type 12, 3R, 4 Standard** Type 4X Stainless Steel Models					
CONTROLLER						
Description	Basic Mechanical Thermostat					
Thermostat Location	Enclosure Side on All Base Models					
Factory Thermostat Setting (°F/°C)	80/27					
SOUND LEVEL						
At 1.5 Meters	68 dB(A)					
UNIT CONSTRUCTION						
Material	Galvanized Sheet Metal Stainless Steel					
Finish	Powder coat RAL 7035 light gray Type 304 stainless steel					
ACCESSORIES						
EASYSWAP Adaptor Plenum (GENESIS M28)	Enables SPECTRACOOOL to be mounted to GENESIS M28 air conditioner cutout Catalog Number PLM28G28					
EASYSWAP Adaptor Plenum (T-Series T29)	Enables SPECTRACOOOL to be mounted to T-Series T29 air conditioner cutout Catalog Number PLT29G28					
UNIT DIMENSIONS						
Height (in./mm)	28.59/726.2	28.59/726.2	28.59/726.2	28.59/726.2	28.59/726.2	28.59/726.2
Width (in./mm)	17.01/432.1	17.01/432.1	17.01/432.1	17.01/432.1	17.01/432.1	17.01/432.1
Depth (in./mm)	11.18/284.0	10.18/258.6	10.18/258.6	10.18/258.6	10.18/258.6	10.18/258.6
Weight (lb./kg)	84/38	84/38	84/38	84/38	84/38	84/38

*Units with Remote Access Control utilize a digital controller and communicate via EtherNet/IP, Profinet, Modbus TCP/IP and SNMP over ethernet or modbus RTU over USB.

**Outdoor Model Partial Recessed Mount units are UL Type 12, 3R only.

Performance Curves for G28 Models 4000 BTU/Hr. (1347/1435 Watt)

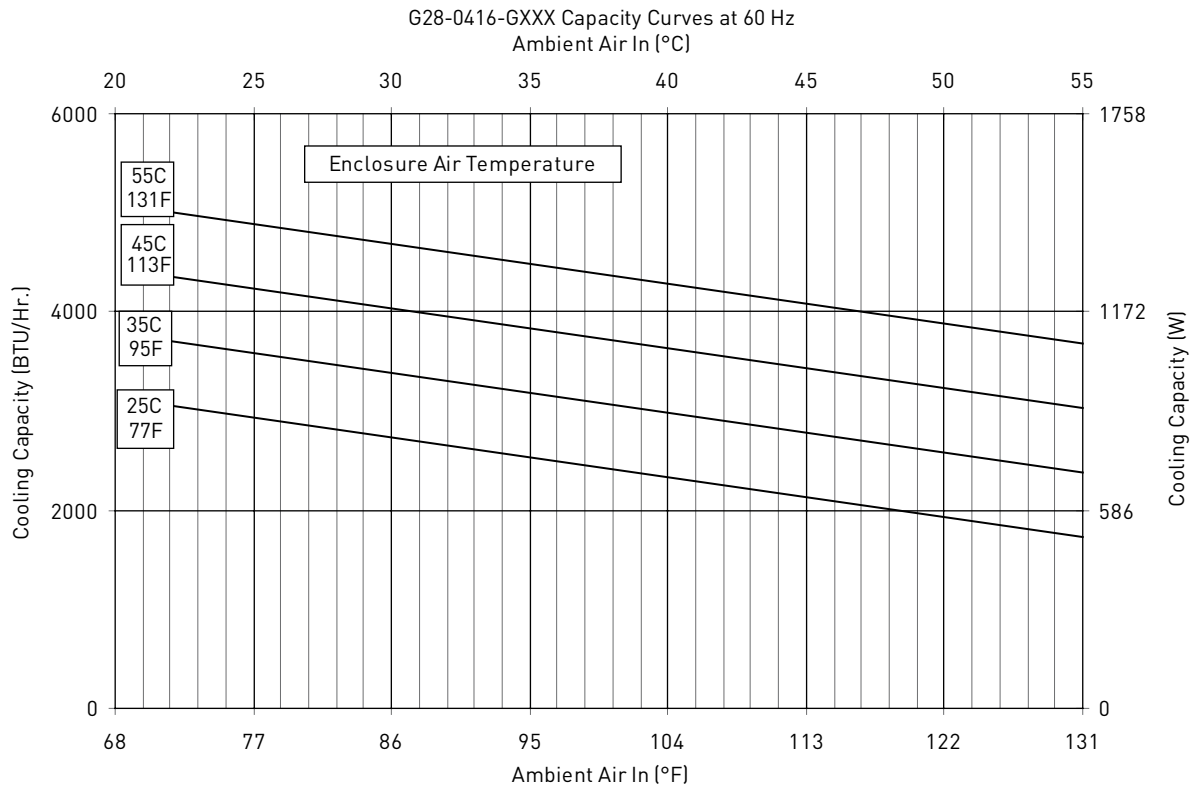
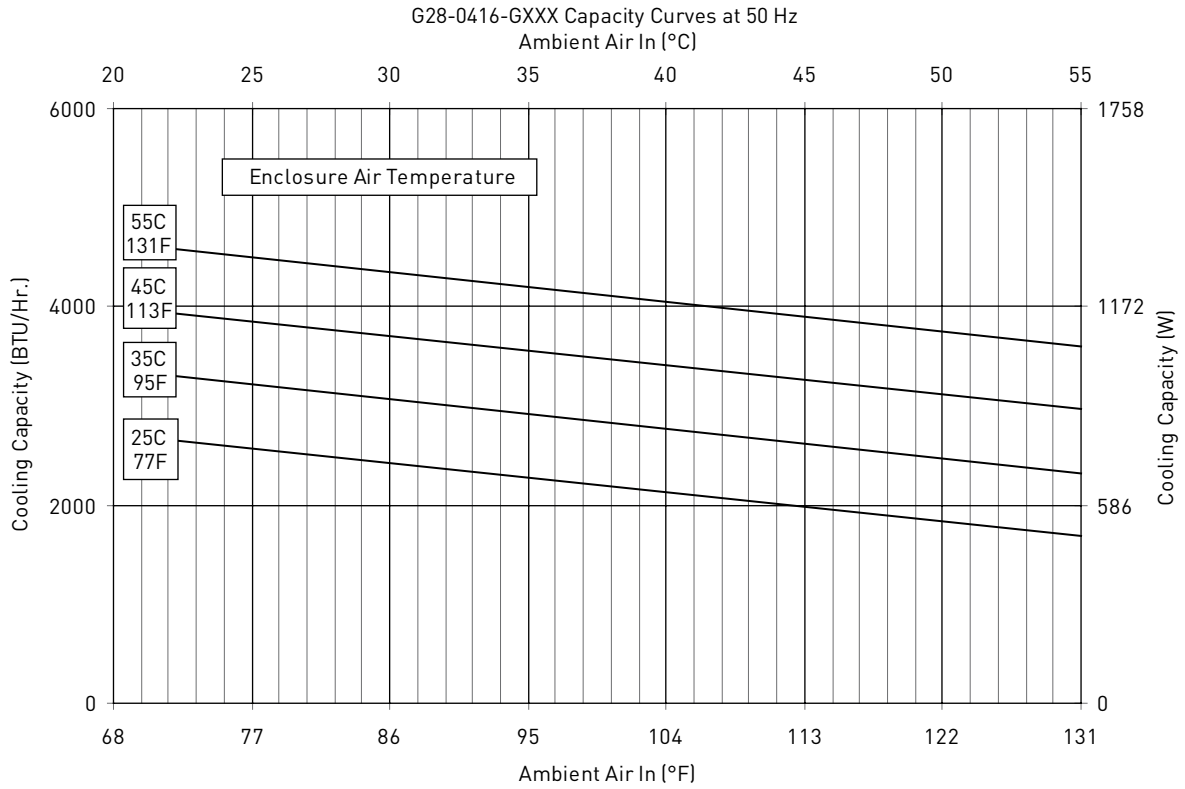

Performance Curves for G28 Models 4000 BTU/Hr. (1347/1435 Watt)

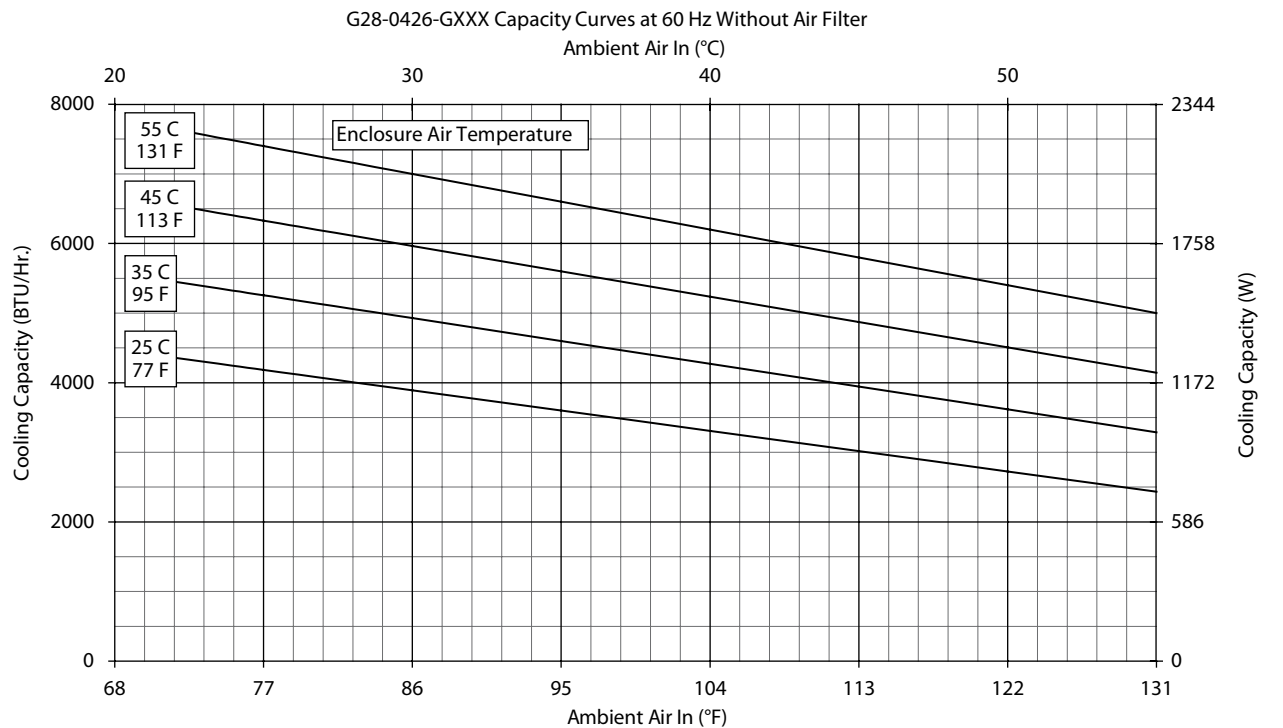
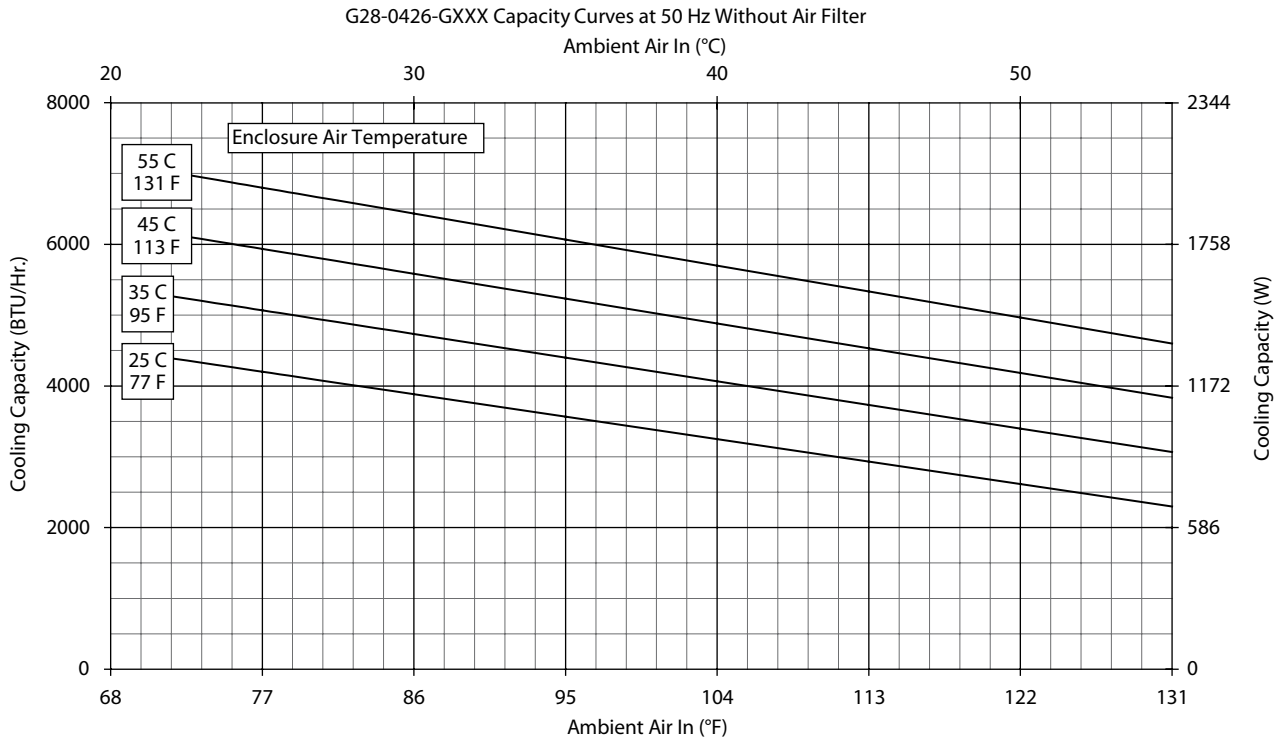

Performance Curves for G28 Models 4000 BTU/Hr. (1347/1435 Watt)

G28-0446-GXXX- Capacity Curves at 50 Hz; Without Filter

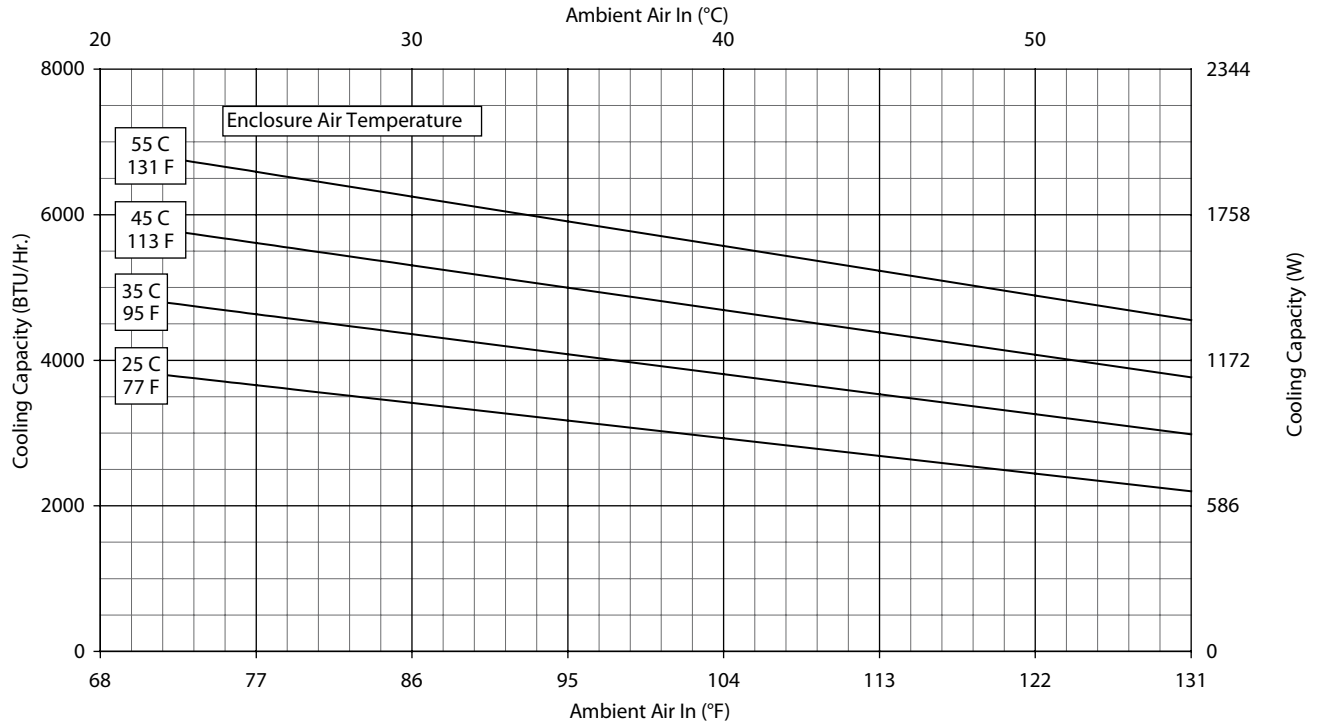

G28-0446-GXXX- Capacity Curves at 60 Hz; Without Filter

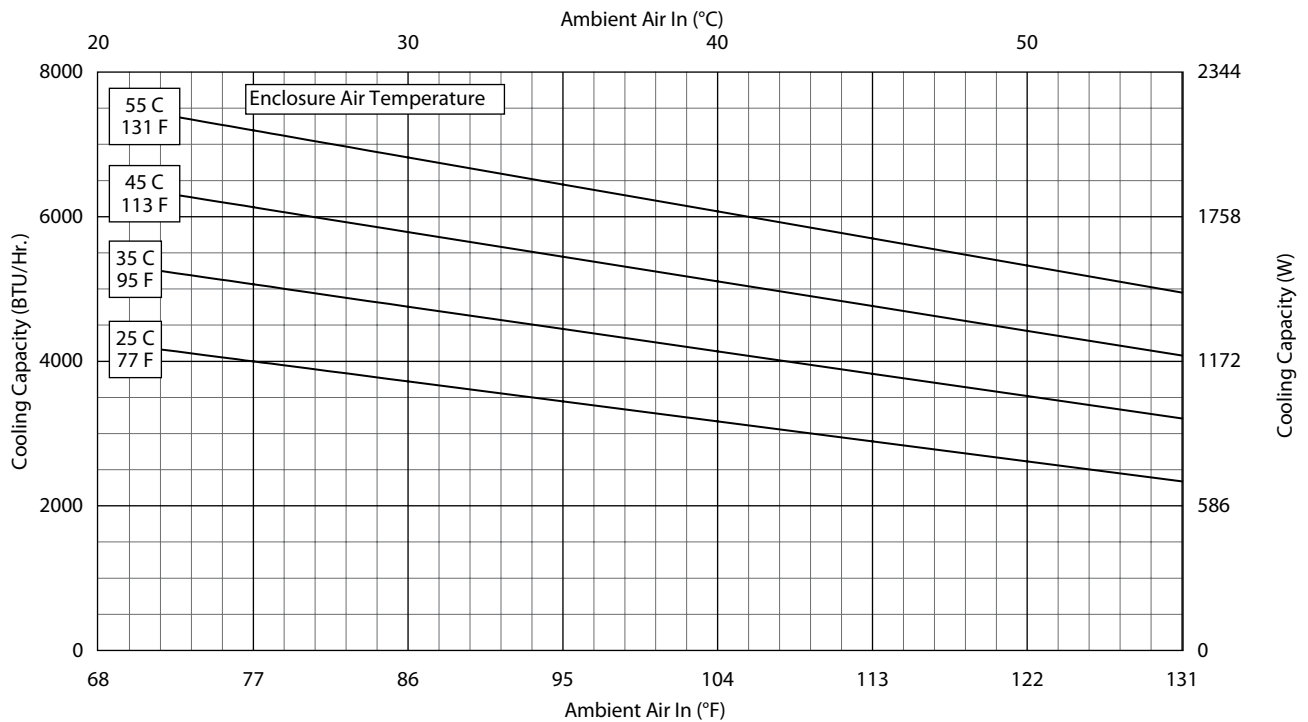

Performance Curves for G28 Models 4000/6000 BTU/Hr. (1172/1758 Watt)

G28-06(1/2)6-GXXX Capacity Curves at 50 Hz Without Filter

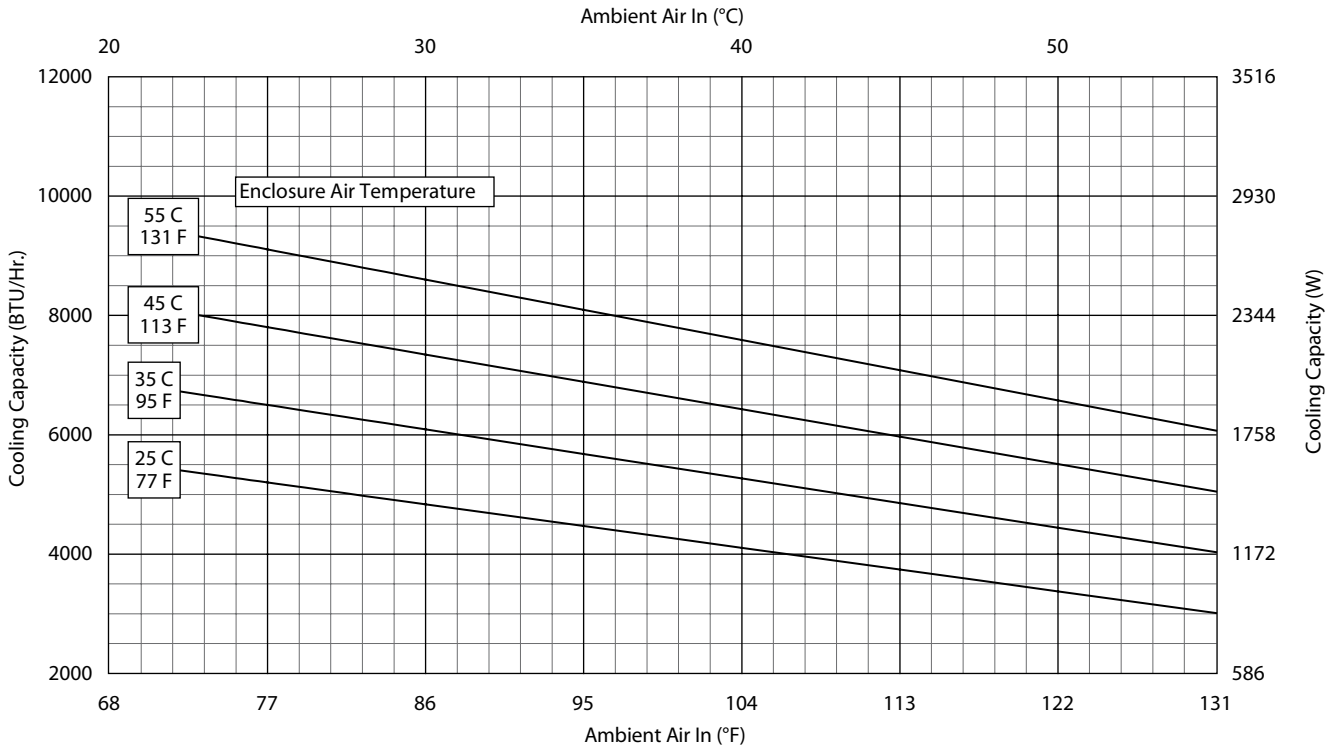

G28-06(1/2)6-G002-P#2 Capacity Curves at 60 Hz Without Filter

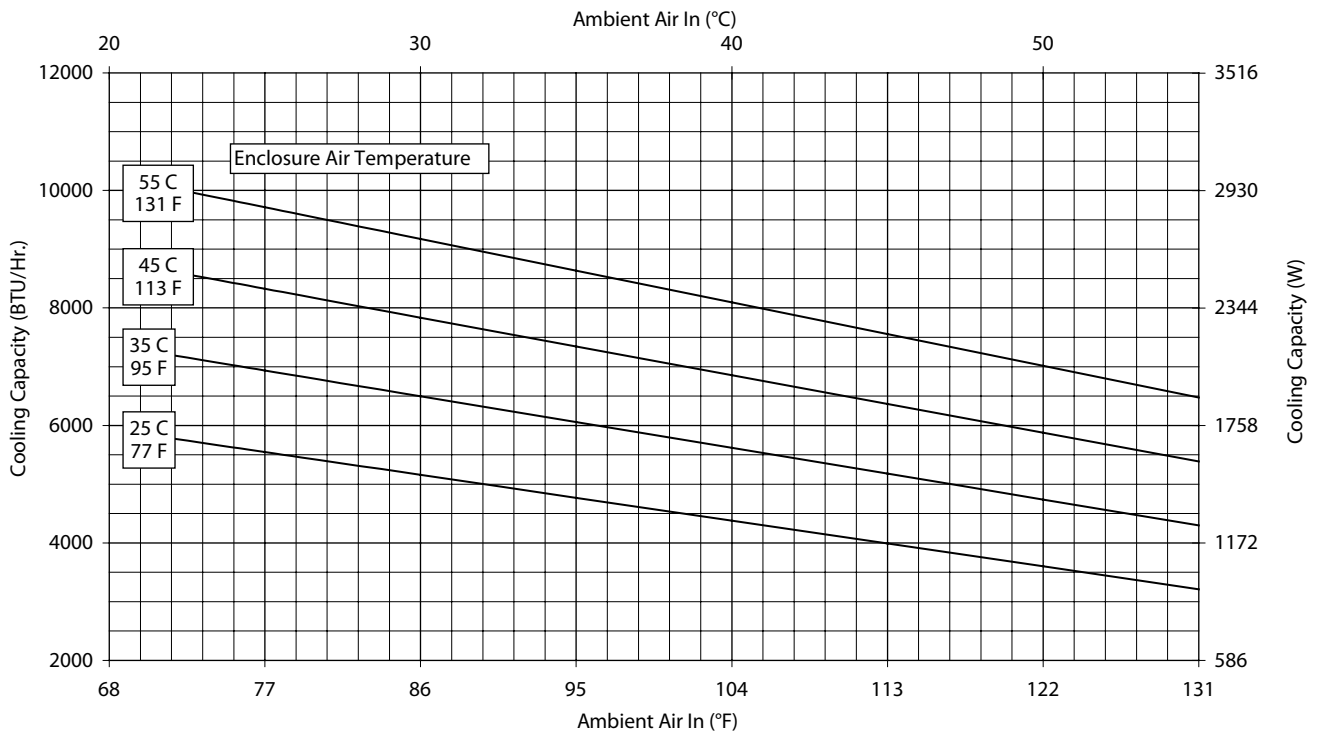

Performance Curves for G28 Models 6000 BTU/Hr. (1758 Watt)

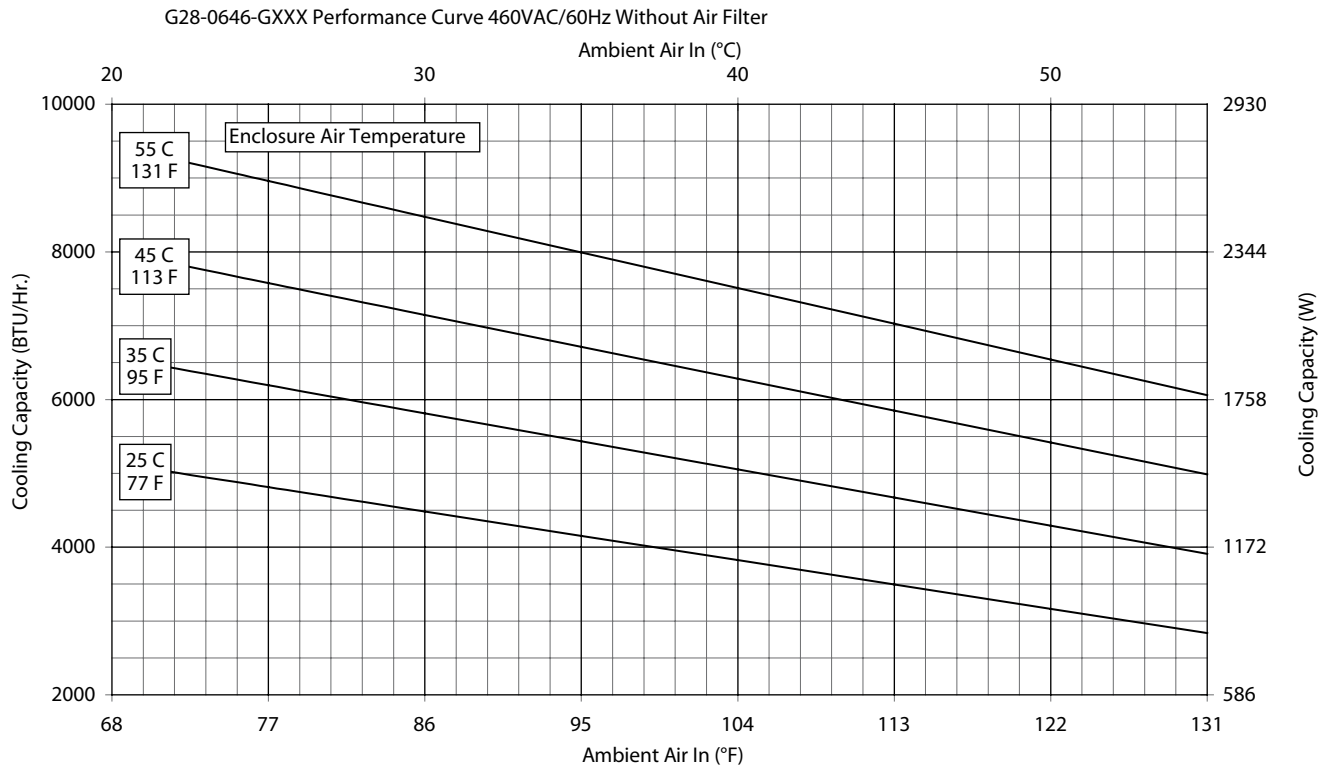
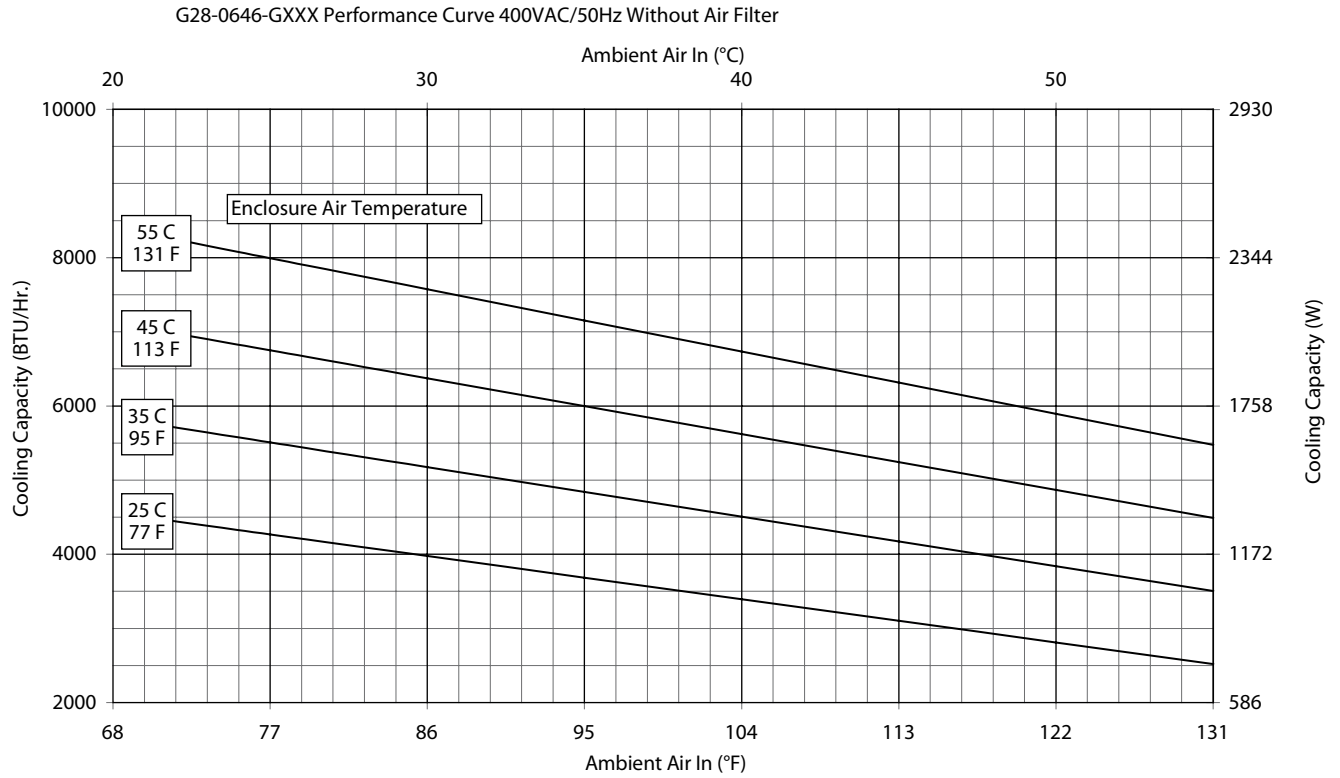

G28 Models 4000 BTU/Hr. 115 V (1172 Watt)

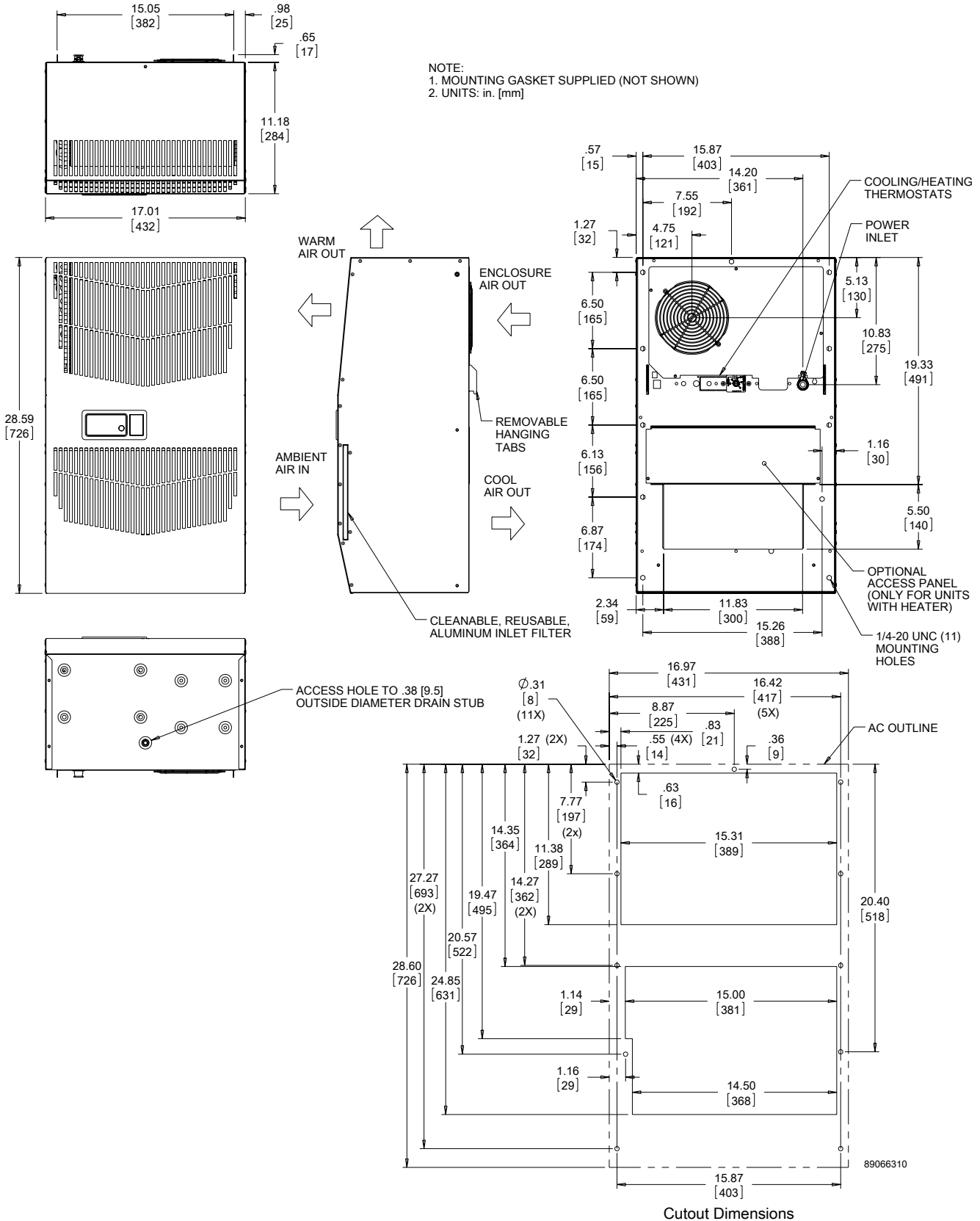

Visit www.nVent.com/HOFFMAN to download 2D and 3D CAD drawings into the overall design of your electrical system.

G28 Models 4000 BTU/Hr. 230/460 V, 6000 BTU/Hr. 115/230/460 V (1172/1757 Watt)

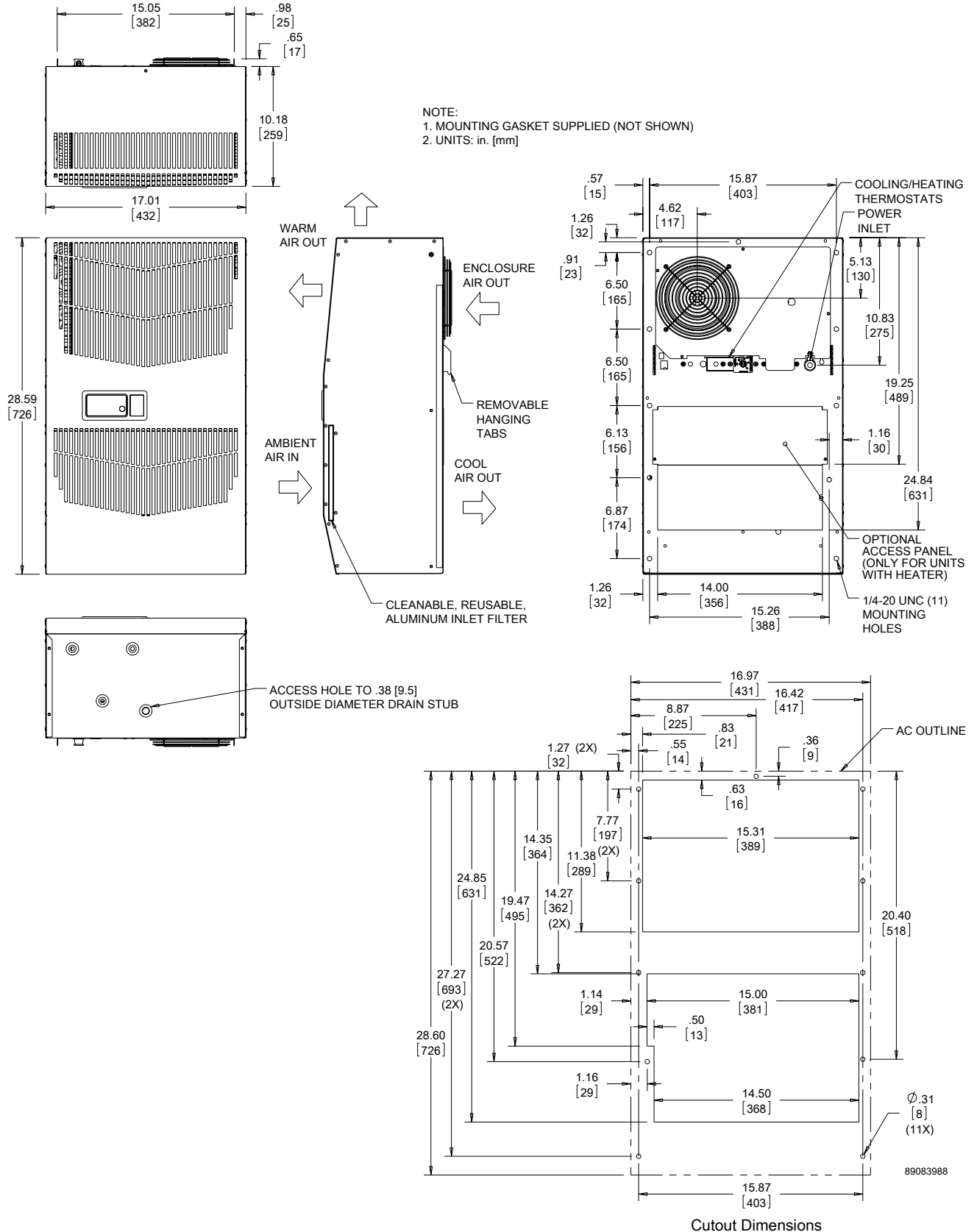

Visit www.nVent.com/HOFFMAN to download 2D and 3D CAD drawings into the overall design of your electrical system.

G28 Models 4000 BTU/Hr. 115 V (1172 Watt) Partial Recess

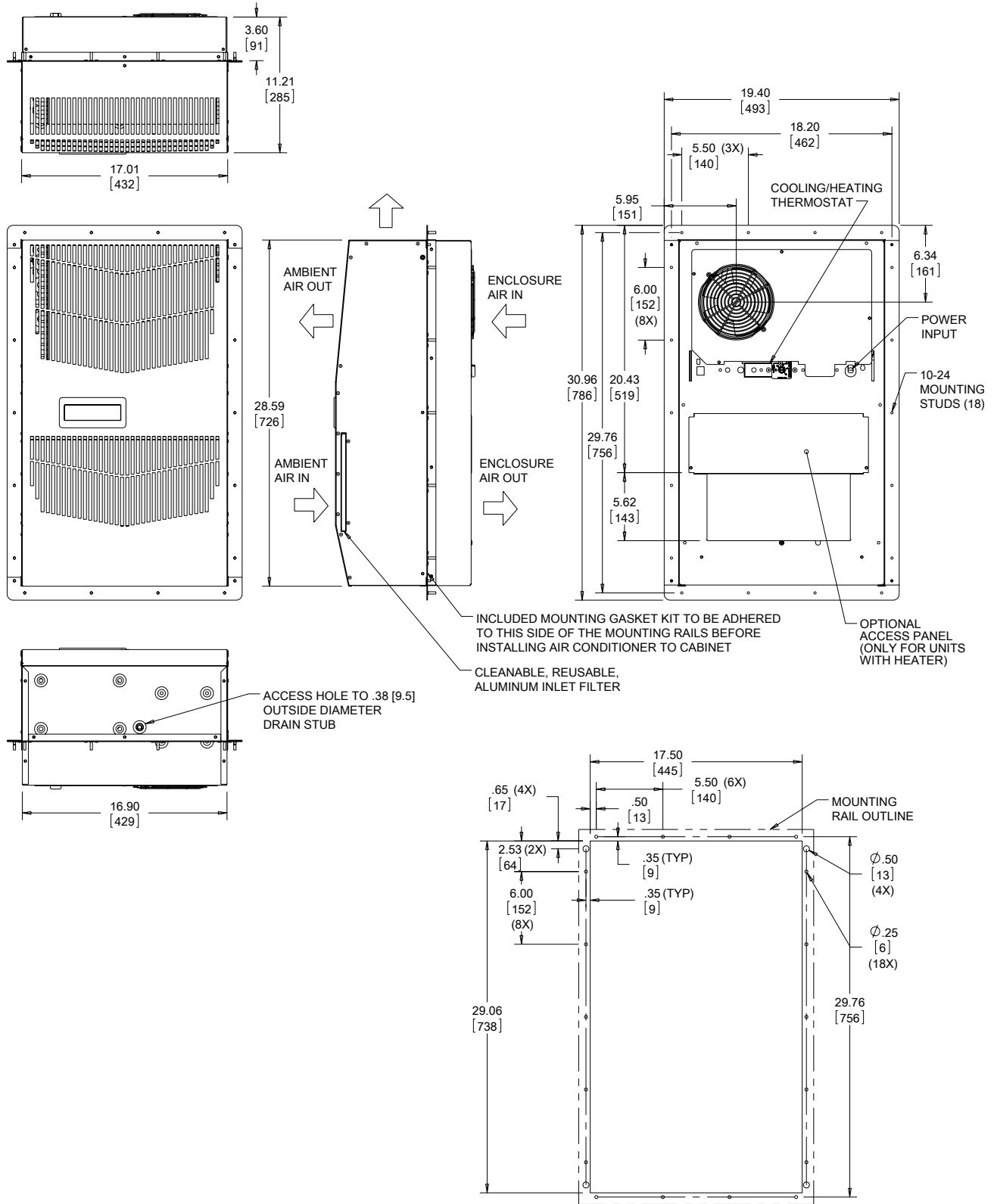

Cutout Dimensions

89066434

Visit www.nVent.com/HOFFMAN to download 2D and 3D CAD drawings into the overall design of your electrical system.

Performance Data **G52 Models 8000/12000 BTU/Hr. (2300/3500 Watt)**

CATALOG NUMBER						
Indoor Model	G520816G050	G520826G050	G520846G050	G521216G050	G521226G050	G521246G050
Indoor Model Stainless Steel Type 4X	G520816G051	G520826G051	G520846G051	G521216G051	G521226G051	G521246G051
Indoor Model with Remote Access Control*	G520816G060	G520826G060	G520846G060	G521216G060	G521226G060	G521246G060
Outdoor Model without Heat Pkg.	G520816G100	G520826G100	G520846G100	G521216G100	G521226G100	G521246G100
Outdoor Model Partial Recessed Mount**	G520816G101	G520826G101	G520846G101	G521216G101	G521226G101	G521246G101
Outdoor Model with Heat Pkg.	G520816G150	G520826G150	G520846G150	G521216G150	G521226G150	G521246G150
Outdoor Model with Heat Pkg. Stainless Steel Type 4X	G520816G151	G520826G151	G520846G151	G521216G151	G521226G151	G521246G151
COOLING PERFORMANCE						
Nominal:						
BTU/Hr.	8000	8000	8000	12000	12000	12000
Watts	2300	2300	2300	3500	3500	3500
At 131 F/131 F (55 C/55 C):						
BTU/Hr.	7611/8363	7300/8200	7636/8314	12000/12500	10914/11679	10448/11583
Watts	2231/2451	2139/2403	2239/2438	3516/3662	3201/3425	3064/3397
At 95 F/95 F (35 C/35 C):						
BTU/Hr.	6134/6793	6000/6800	6716/7112	9900/10700	9219/9913	8660/9757
Watts	1798/1991	1758/1992	1970/2086	2900/3135	2704/2907	2540/2861
Refrigerant	R134a	R134a	R134a	R134a	R134a	R134a
Refrigerant Charge (ounces/grams)	20/567	24/680	23/652	38/1077	36/1021	38/1077
Operating Temperature Range:						
Maximum (°F/°C)	131/55	131/55	131/55	131/55	131/55	131/55
Indoor Minimum (°F/°C)	50/10	50/10	50/10	50/10	50/10	50/10
Outdoor Minimum (°F/°C)	-40/-40	-40/-40	-40/-40	-40/-40	-40/-40	-40/-40
Airflow at 0 Static Pressure:						
Internal loop 50 Hz (CFM / m ³ /hr.)	285/484	285/484	285/484	287/487	287/487	287/487
External loop 50 Hz (CFM / m ³ /hr.)	650/1104	650/1104	650/1104	635/1078	635/1078	635/1078
Internal loop 60 Hz (CFM / m ³ /hr.)	310/527	310/527	310/527	305/518	305/518	305/518
External loop 60 Hz (CFM / m ³ /hr.)	700/1189	700/1189	700/1189	650/1104	650/1104	650/1104
Max. Heater W (Outdoor Models):	2000	2000	2000	2000	2000	2000
ELECTRICAL DATA						
Rated Voltage	115	230/208-230	400/460 3~	115	230/208-230	400/460 3~
Frequency (Hz)	50/60	50/60	50/60	50/60	50/60	50/60
Operating Range	+/- 10%	+/- 10%	+/- 10%	+/- 10%	+/- 10%	+/- 10%
Max. Power Consumption (W)	1111/1332	1250/1415	1342/1724	2100/2427	1839/2297	1610/2005
Max. Nominal Current (A at 50/60 Hz)	9.9/11.4	5.6/7.0-6.2	2.4/2.8	16.1/21.0	8.0/10.9-10.2	3.2/3.5
Starting Current (A)	38	27	13	57	30	20
Agency Approvals	UL/cUL Listed CE EAC Others available upon request Terminal Block					
Power Input Description	Terminal Block					
ENCLOSURE PROTECTION						
UL Type	Type 12, 3R, 4 standard** Type 4X Stainless steel models					
International Rating	IP56 internal loop IP34 external loop					
CONTROLLER						
Description	Basic mechanical thermostat with digital display					
Thermostat Location	Enclosure side on all base models					
Digital Display Location:						
Indoor Models	Ambient side					
Outdoor Models	Enclosure side					
Factory Thermostat Setting (F/C)	80/27					
SOUND LEVEL						
At 1.5 Meters	68 dB(A)					
UNIT CONSTRUCTION						
Material	Galvanized sheet metal Stainless steel					
Finish	Powder coat RAL 7035 light gray Type 304 stainless steel					
ACCESSORIES						
EASYSWAP Adaptor Plenum (GENESIS M52)	Enables SPECTRACOOOL to be mounted to a GENESIS M52 air conditioner cutout Catalog Number PLM52G52					
UNIT DIMENSIONS						
Height (in./mm)	52.69/1338					
Width (in./mm)	17.12/435					
Depth (in./mm)	11.66/296					
Weight (lb./kg)	128/58.1	128/58.1	138/62.6	131/59.4	131/59.4	141/64.0

*Units with Remote Access Control utilize a digital controller and communicate via EtherNet/IP, Profinet, Modbus TCP/IP and SNMP over ethernet or modbus RTU over USB.

**Outdoor Model Partial Recessed Mount units are UL Type 12, 3R only.

Performance Curves for G52 Models 8000 BTU/Hr. (23 Watt)

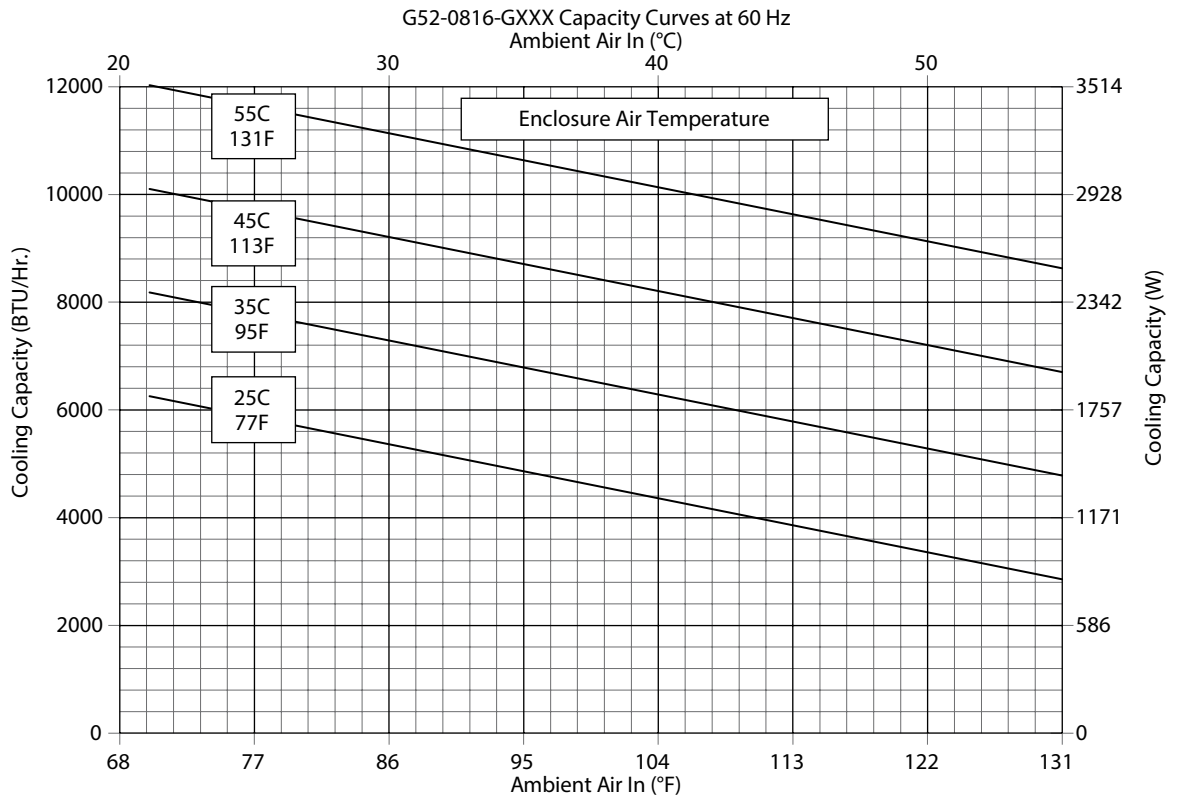
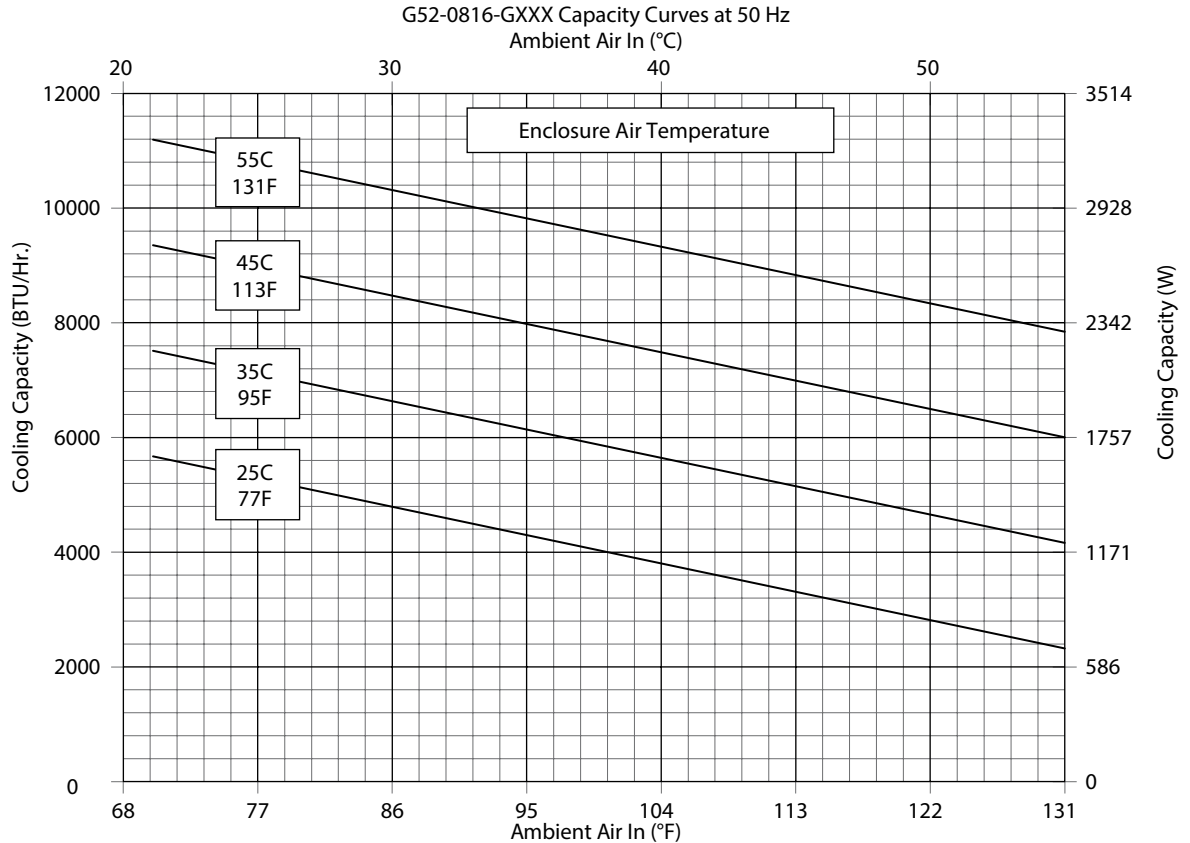

Performance Curves for G52 Models 8000 BTU/Hr. (23 Watt)

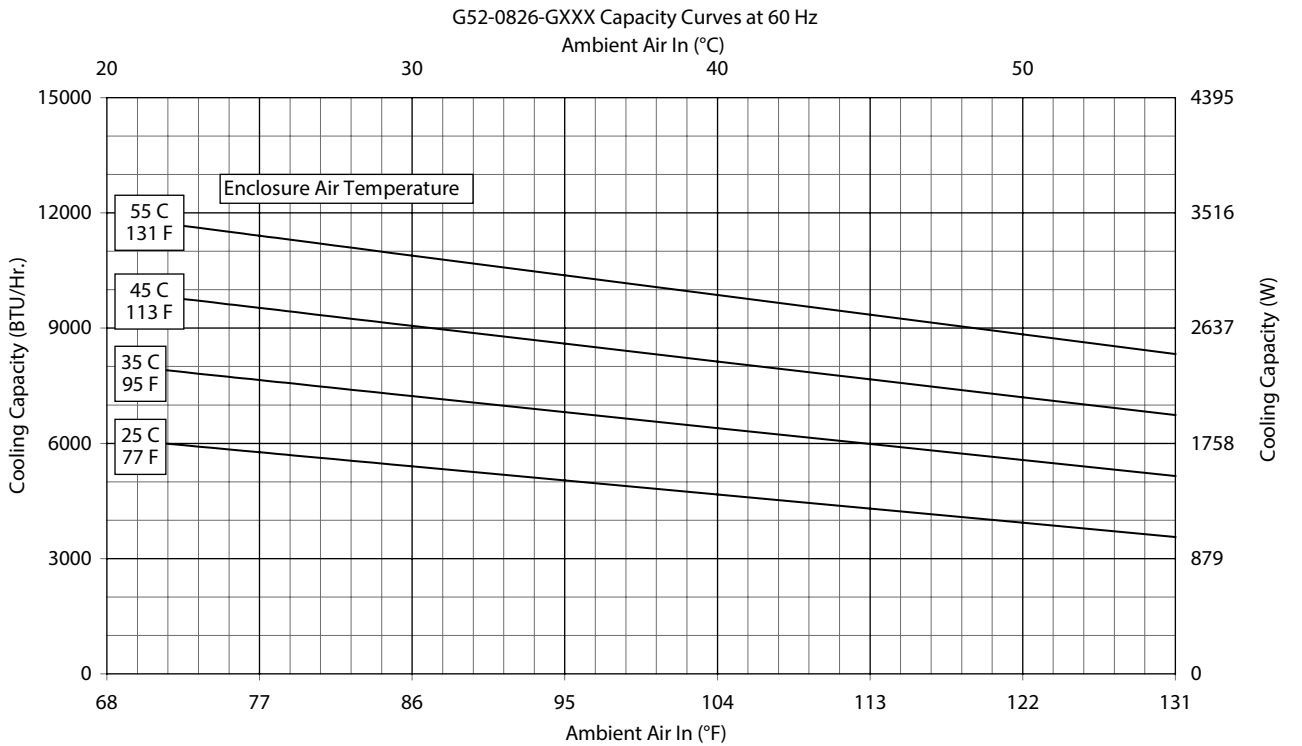
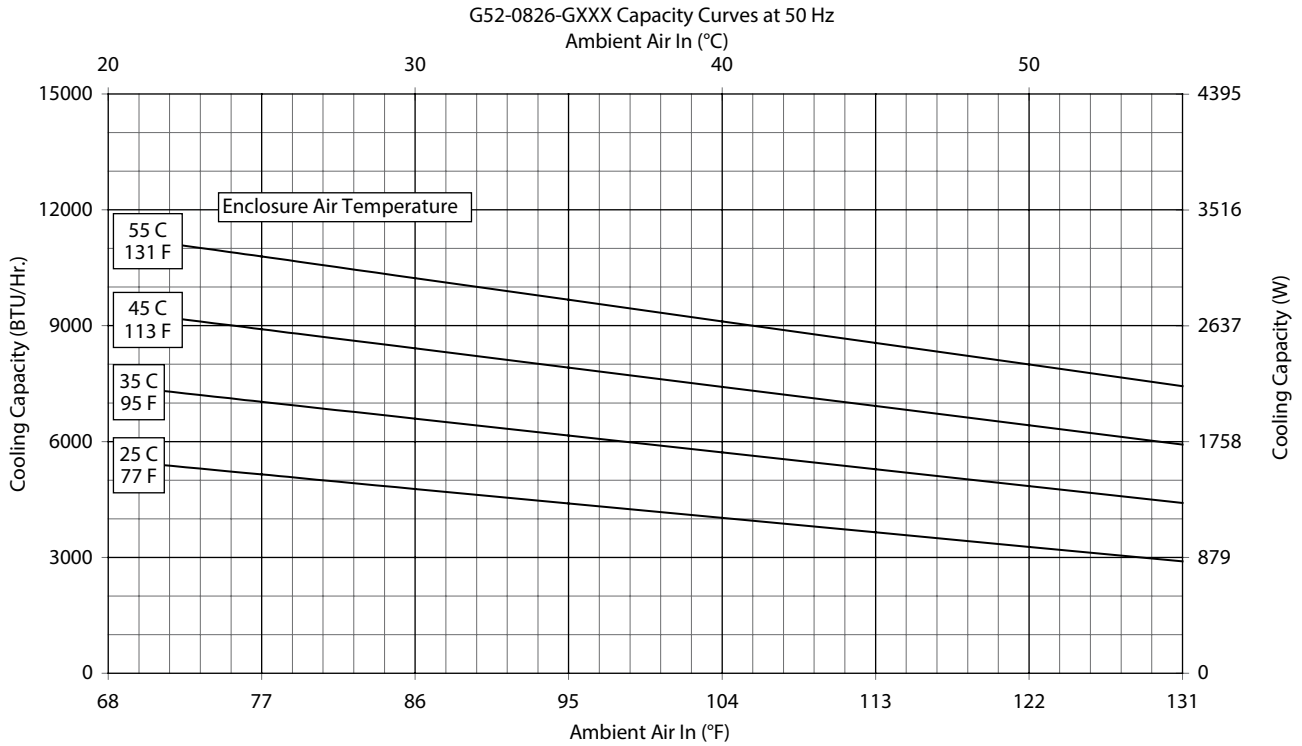

Performance Curves for G52 Models 8000 BTU/Hr. (2300 Watt)

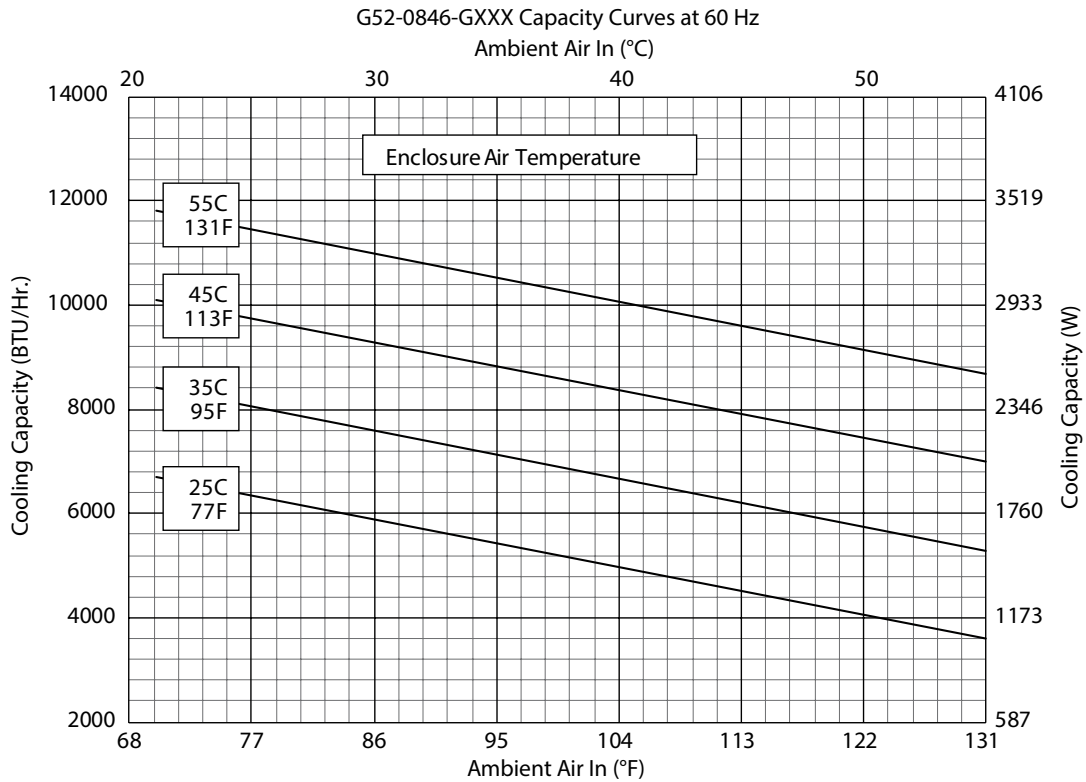
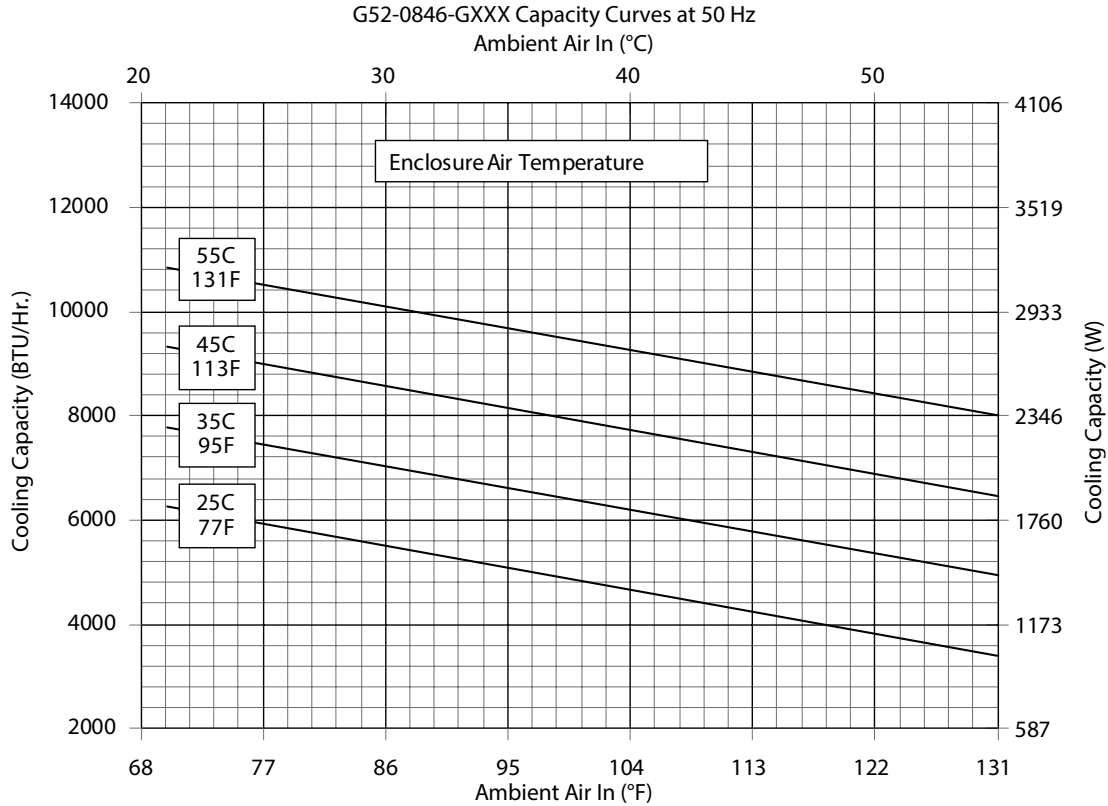

Performance Curves for G52 Models 12000 BTU/Hr. (3500 Watt)

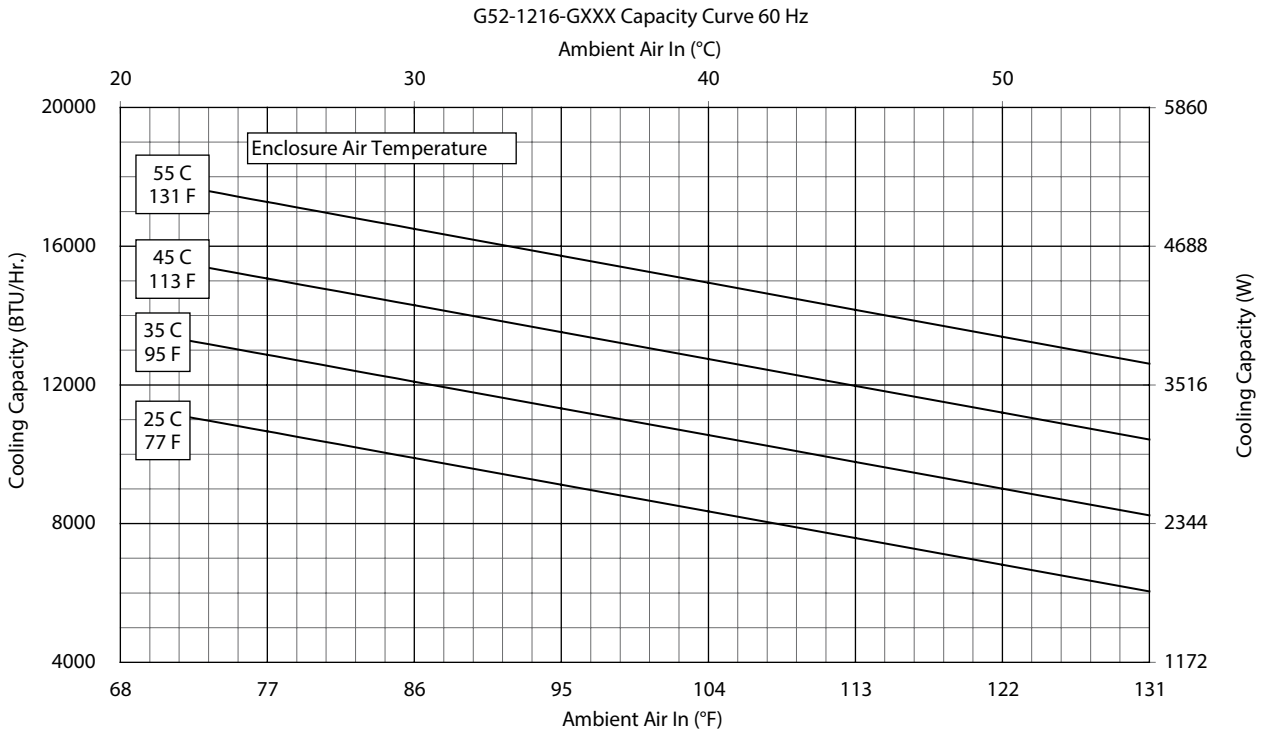
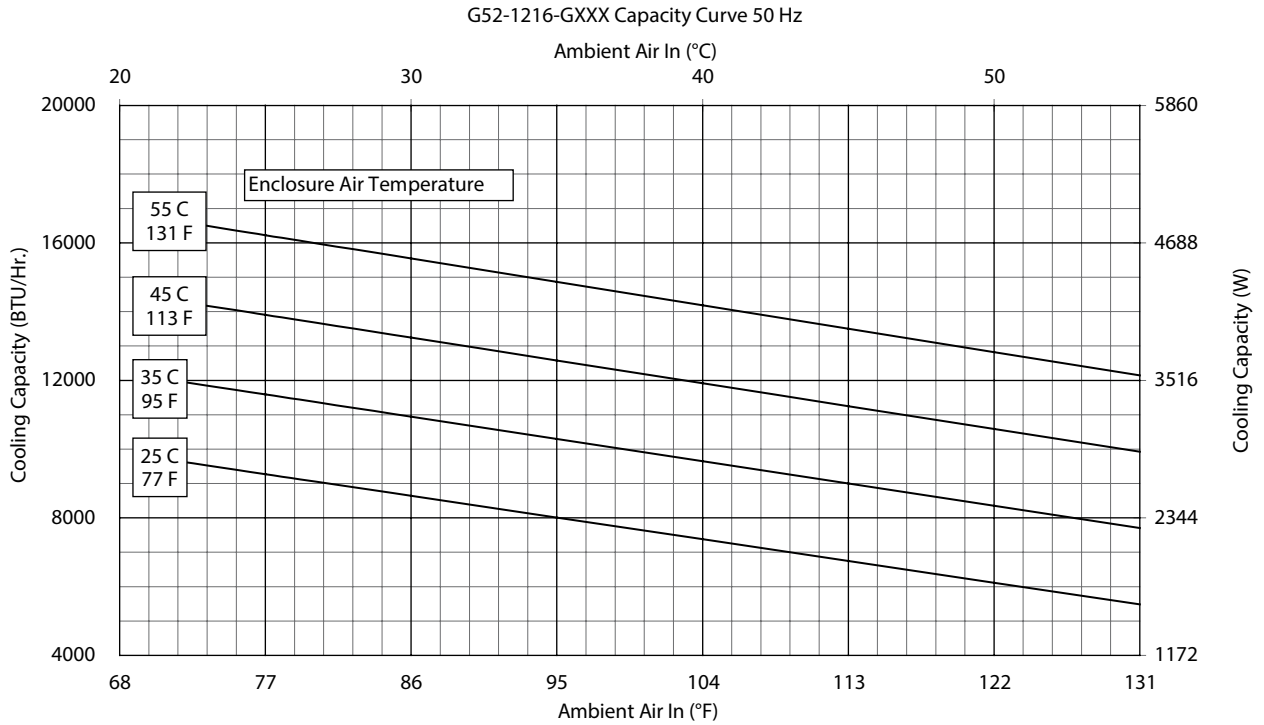

Performance Curves for G52 Models 12000 BTU/Hr. (3500 Watt)

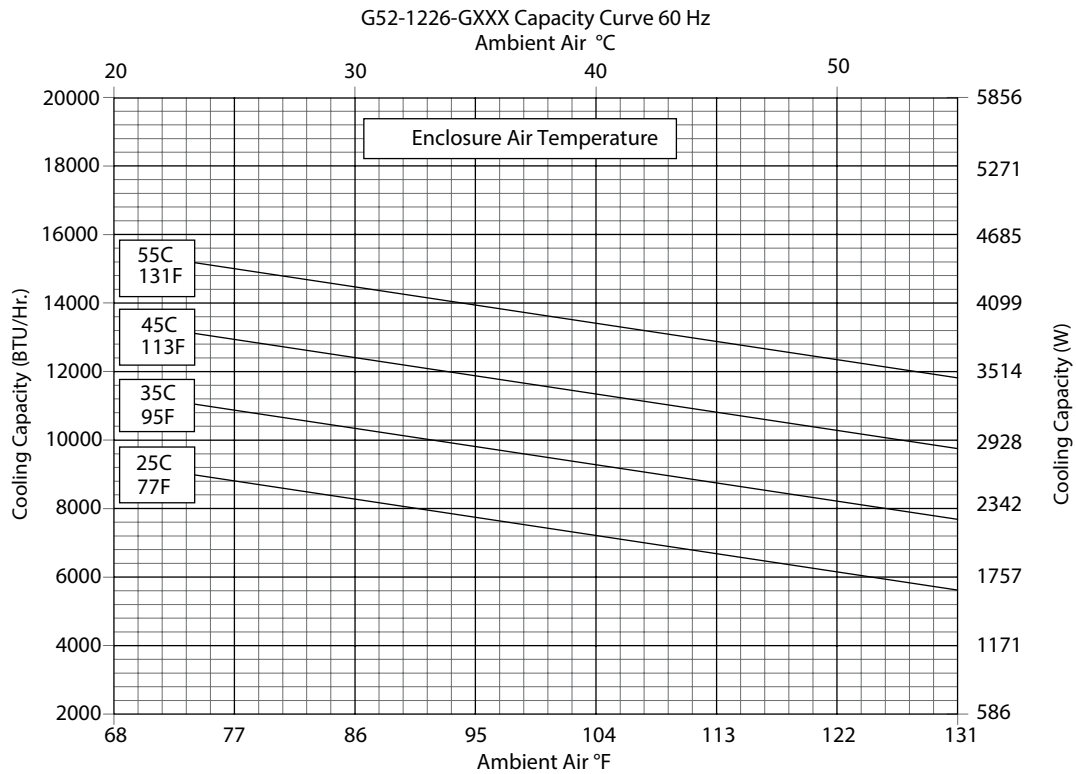
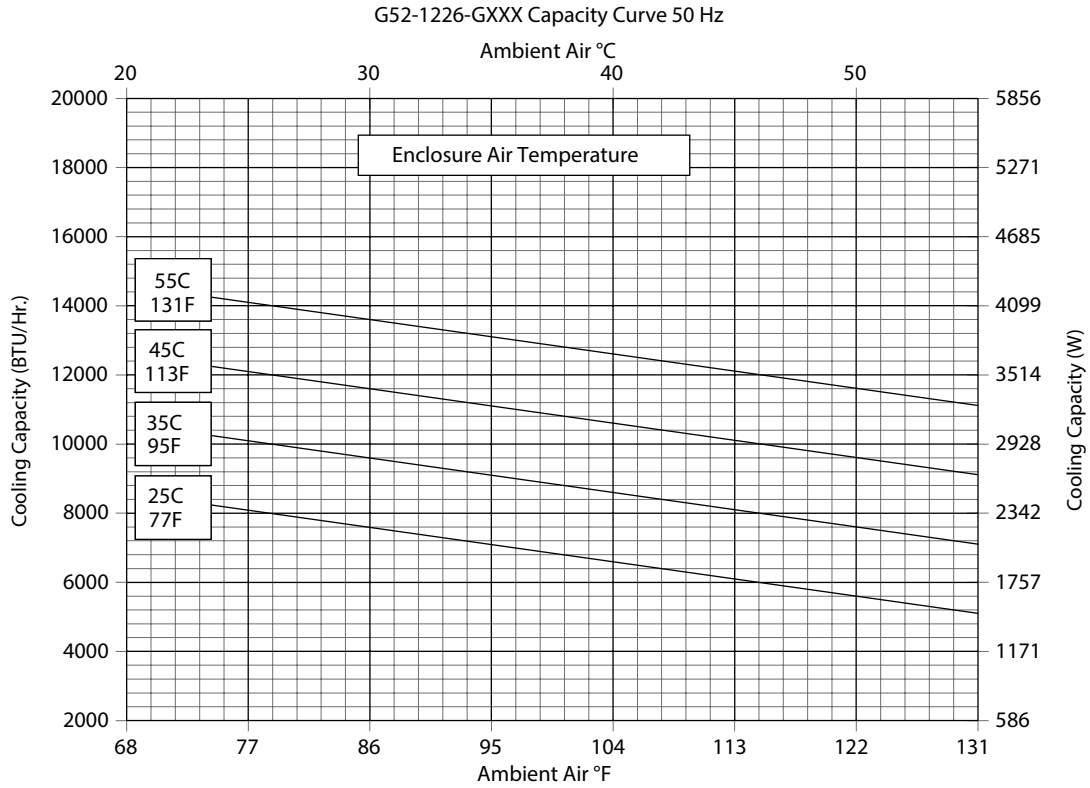

Performance Curves for G52 Models 12000 BTU/Hr. (3516 Watt)

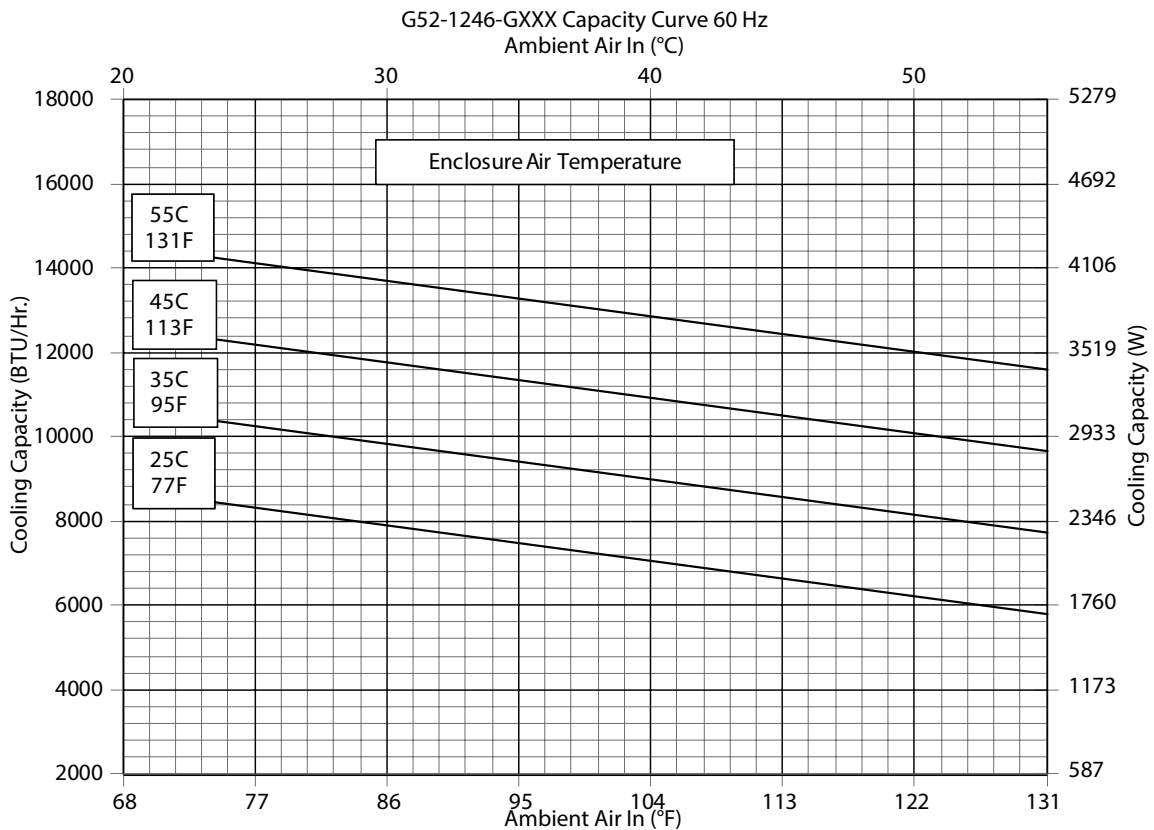
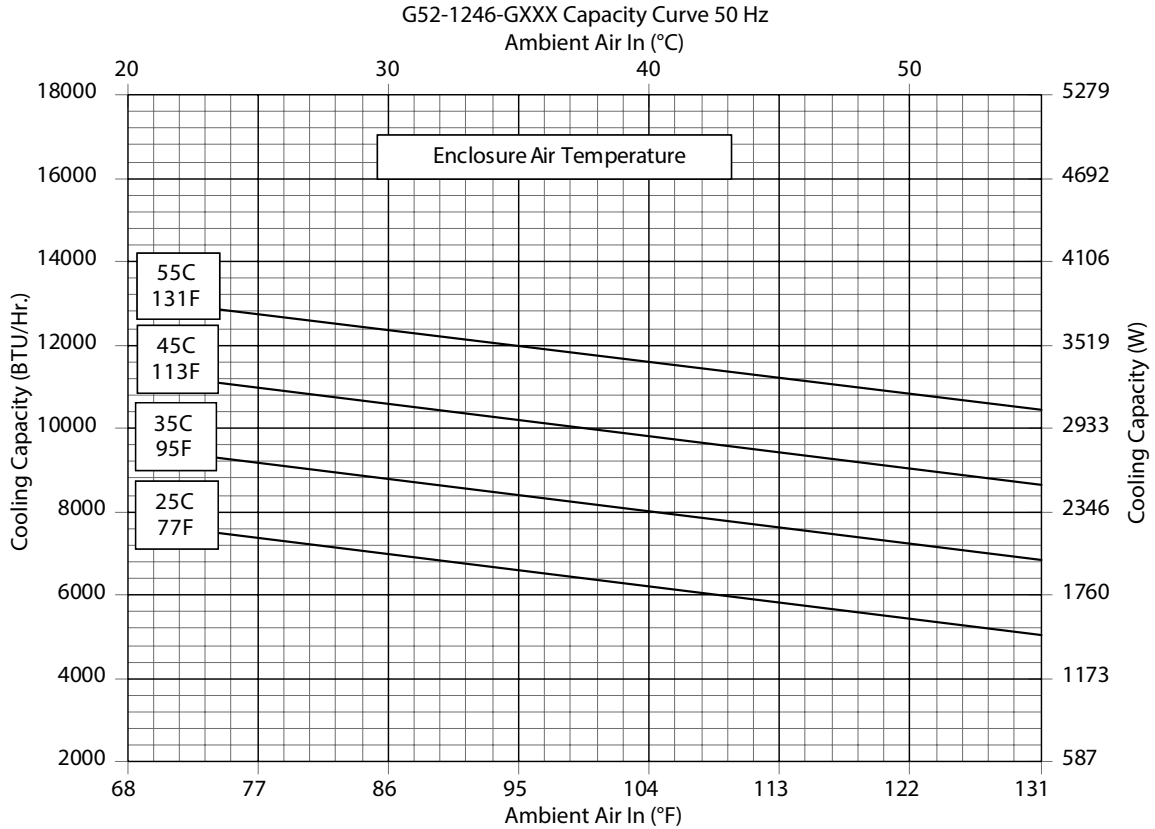

G52 Models 8000/12000 BTU/Hr. (2300/3500 Watt)

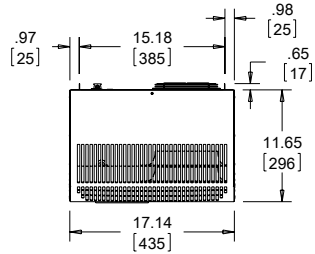

NOTE:
 1. MOUNTING GASKET SUPPLIED (NOT SHOWN)
 2. UNITS: in. [mm]

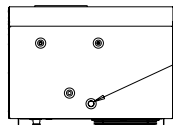
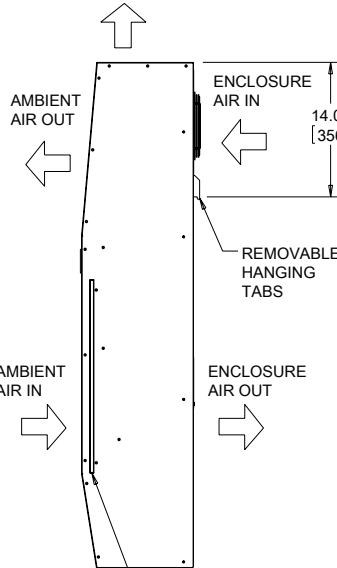
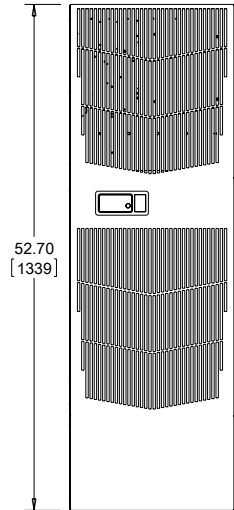

CLEANABLE, REUSABLE ALUMINUM INLET FILTER

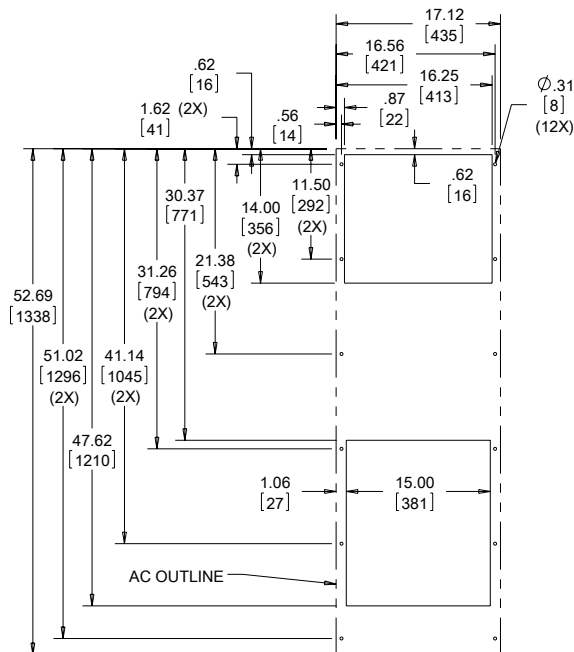
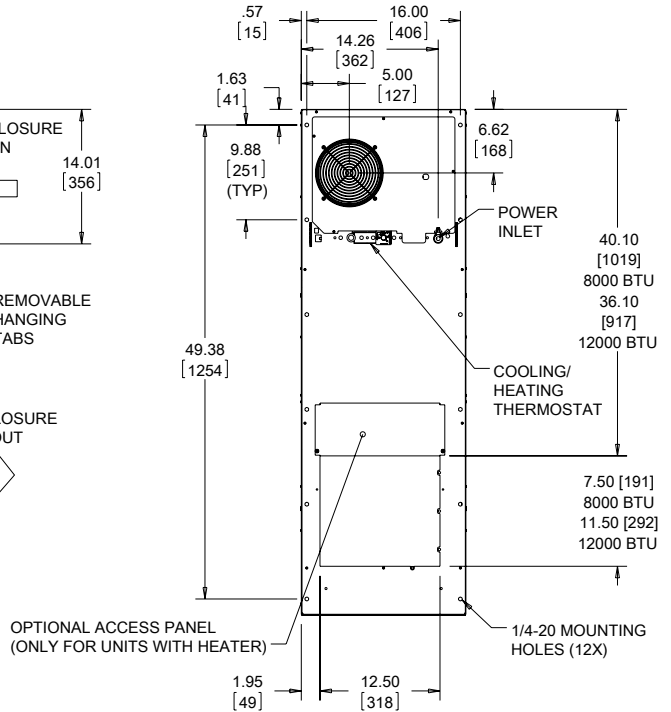

Cutout Dimensions (Standard)

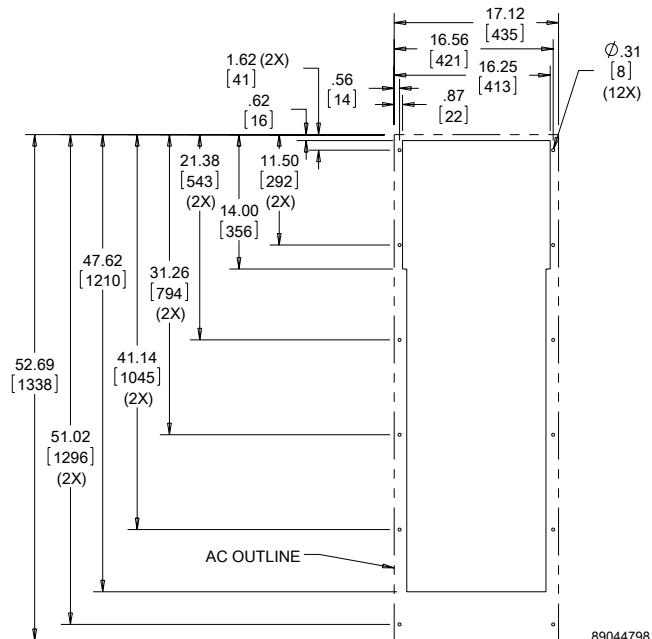

Cutout Dimensions (G520846G150, G520846G151, G521246G150, G521246G151 only)

Visit www.nVent.com/HOFFMAN to download 2D and 3D CAD drawings into the overall design of your electrical system.

G52 Models 8000/12000 BTU/Hr. (2344/3516 Watt) with Partial Recess

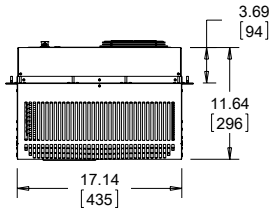

NOTE:
 1. MOUNTING GASKET SUPPLIED (NOT SHOWN)
 2. UNITS: in. [mm]

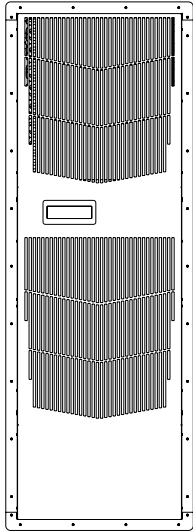

CLEANABLE, REUSABLE ALUMINUM INLET FILTER

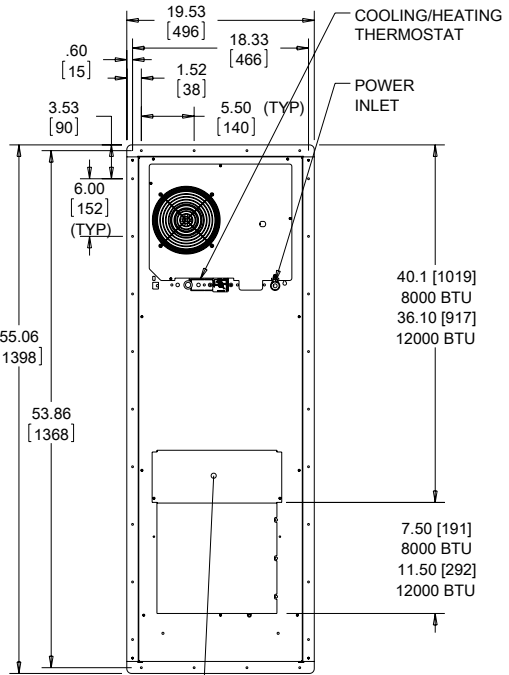
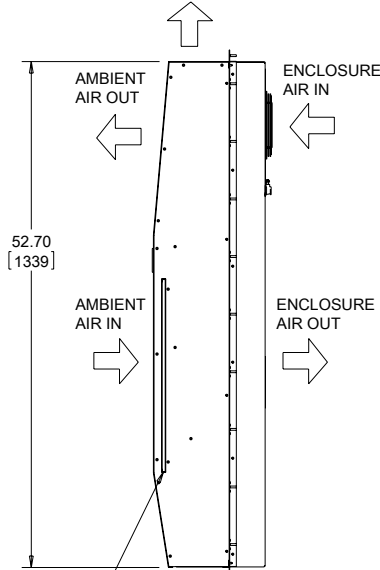

OPTIONAL ACCESS PANEL (ONLY FOR UNITS WITH HEATER)
 INCLUDED MOUNTING GASKET KIT TO BE ADHERED TO THIS SIDE OF MOUNTING RAILS BEFORE INSTALLING AIR CONDITIONER TO CABINET

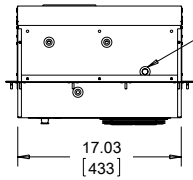

ACCESS HOLE TO .38 [9.5] OUTSIDE DIAMETER DRAIN STUB

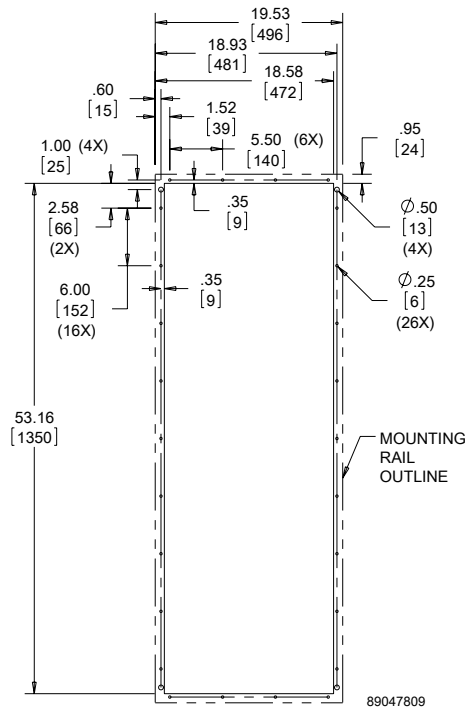

Cutout Dimensions

Visit www.nVent.com/HOFFMAN to download 2D and 3D CAD drawings into the overall design of your electrical system.

Performance Data **G57 Models 20000 BTU/Hr. (5861 Watt)**

CATALOG NUMBER		
Indoor Model	G572026G050	G572046G050
Indoor Model Stainless Steel Type 4X	G572026G051	G572046G051
Indoor Model with Remote Access Control*	G572026G060	G572046G060
Outdoor Model without Heat Pkg.	G572026G100	G572046G100
Outdoor Model Partial Recessed Mount**	G572026G101	G572046G101
Outdoor Model with Heat Pkg.	G572026G150	G572046G150
Outdoor Model with Heat Pkg. Stainless Steel Type 4X	G572026G151	G572046G151
COOLING PERFORMANCE		
Nominal:		
BTU/Hr.	20000	20000
Watts	5861	5861
At 131 F/131 F (55 C/55 C):		
BTU/Hr. (50/60 Hz)	17500/19600	21400/23400
W (50/60 Hz)	5129/5744	6272/6857
At 95 F/95 F (35 C/35 C):		
BTU/Hr. (50/60 Hz)	16000/18000	19300/21400
W (50/60 Hz)	4689/5275	5656/6272
Refrigerant	R407c	R407c
Refrigerant Charge (ounces/grams)	50/1417	48/1361
Operating Temperature Range:		
Maximum (°F/°C)	131/55	131/55
Indoor Minimum (°F/°C)	50/10	50/10
Outdoor Minimum (°F/°C)	-40/-40	-40/-40
Airflow at 0 Static Pressure:		
Internal loop 50 Hz (CFM / m ³ /hr.)	513/872	513/872
External loop 50 Hz (CFM / m ³ /hr.)	919/1562	919/1562
Internal loop 60 Hz (CFM / m ³ /hr.)	587/998	587/998
External loop 60 Hz (CFM / m ³ /hr.)	1055/1794	1055/1794
Max. Heater W (Outdoor Models)	3000	3000
ELECTRICAL DATA		
Rated Voltage	230/230	400/460 3~
Frequency (Hz)	50/60	50/60
Operating Range	+/- 10%	+/- 10%
Max. Power Consumption (W at 50/60 Hz)	4508/5106	4017/5043
Max. Nominal Current (A at 50/60 Hz)	19.6/22.2	6.0/6.8
Starting Current (A)	63	27
Agency Approvals	UL/cUL Listed CE EAC Others available upon request	
Power Input Description	Terminal Block	
ENCLOSURE PROTECTION		
UL Type	Type 12, 3R, 4 standard** Type 4X stainless steel models	
International Rating	IP56 internal loop IP34 external loop	
CONTROLLER		
Description	Basic mechanical thermostat with digital display	
Thermostat Location	Enclosure side on all base models	
Digital Display Location:		
Indoor Models	Ambient side	
Outdoor Models	Enclosure side	
Factory Thermostat Setting (°F/°C)	80/27	
SOUND LEVEL		
At 1.5 Meters	74.1 dB(A)	
UNIT CONSTRUCTION		
Material	Galvanized sheet metal Stainless steel	
Finish	Powder coat RAL 7035 light gray Type 304 stainless steel	
ACCESSORIES		
EASYSWAP Adaptor Plenum (T-Series T53)	Enables SPECTRACOOOL to be mounted to a T-Series T53 air conditioner cutout part #57721601SP	
UNIT DIMENSIONS		
Height (in./mm)	57.69/1465.4	
Width (in./mm)	20.87/530.1	
Depth (in./mm)	15.28/388.1	
Weight (lb./kg)	197/89	

*Units with Remote Access Control utilize a digital controller and communicate via EtherNet/IP, Profinet, Modbus TCP/IP and SNMP over ethernet or modbus RTU over USB.

**Outdoor Model Partial Recessed Mount units are UL Type 12, 3R only.

Performance Curves for G57 Models 20000 BTU/Hr.

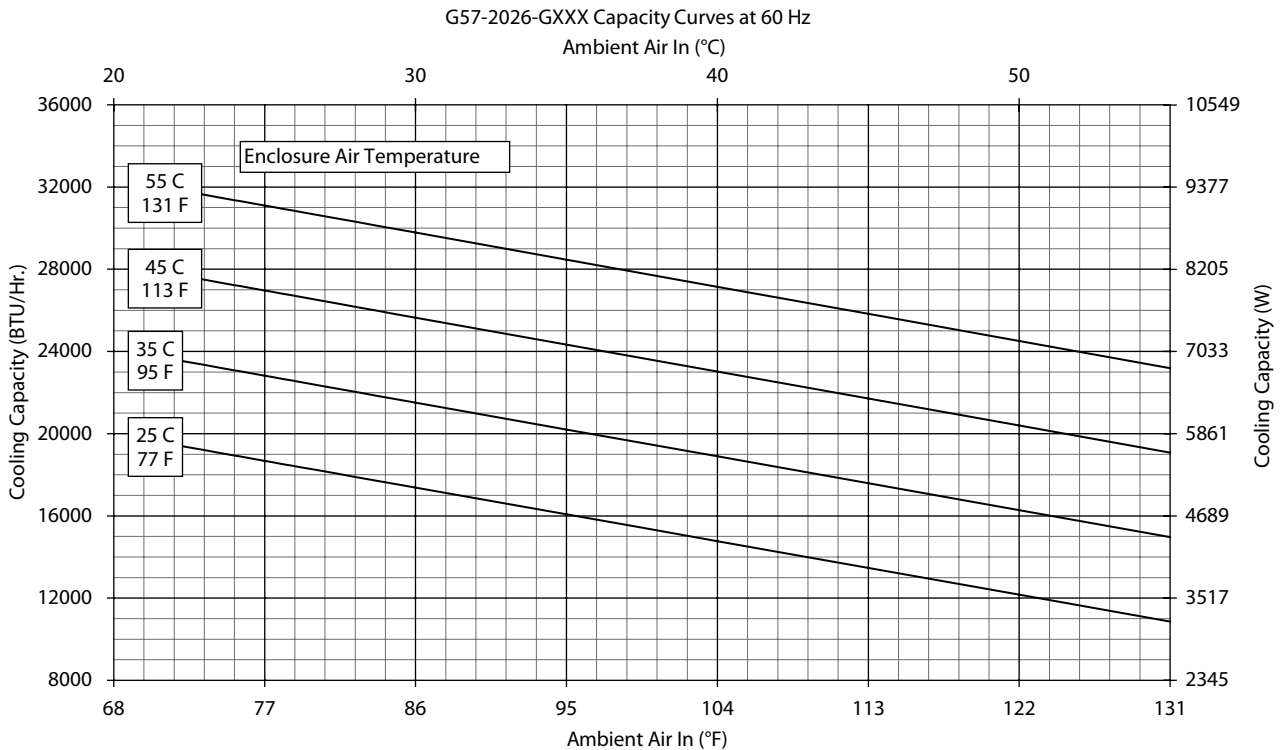
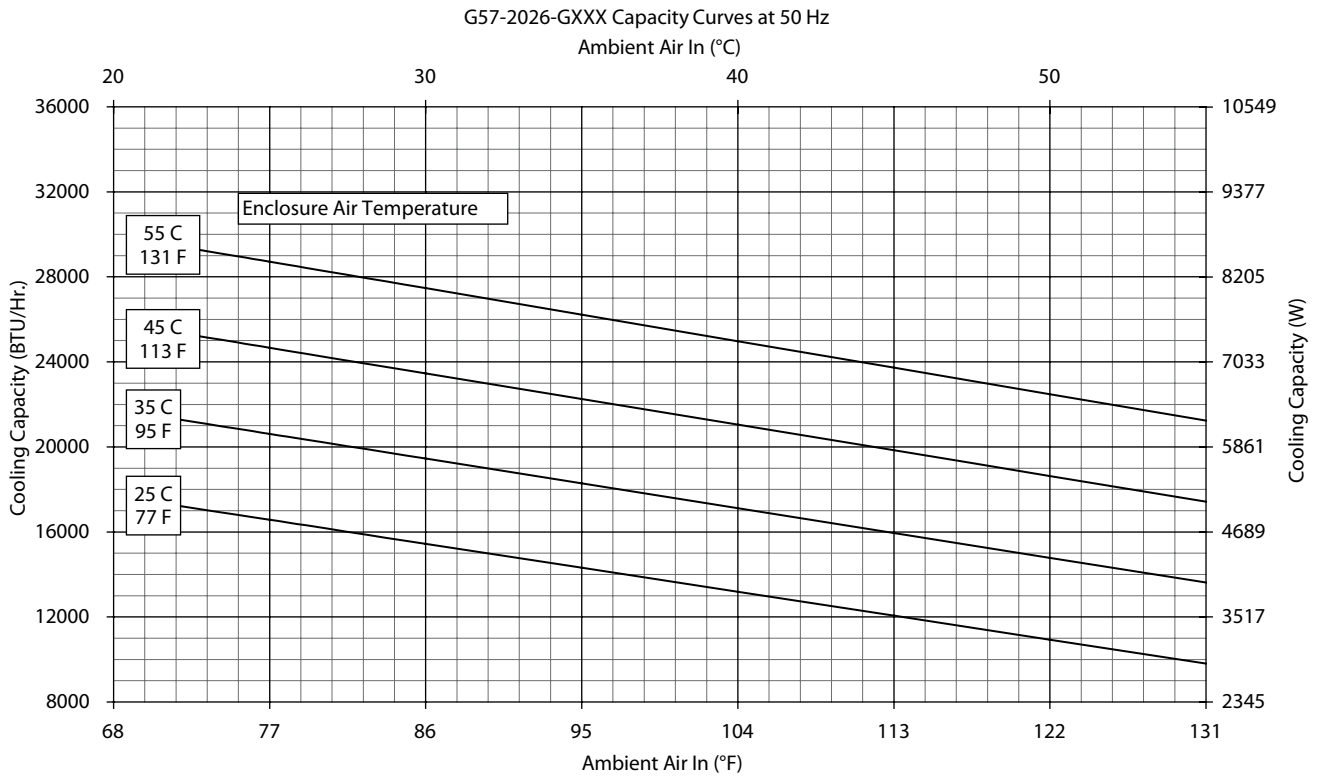

Performance Curves for G57 Models 20000 BTU/Hr.

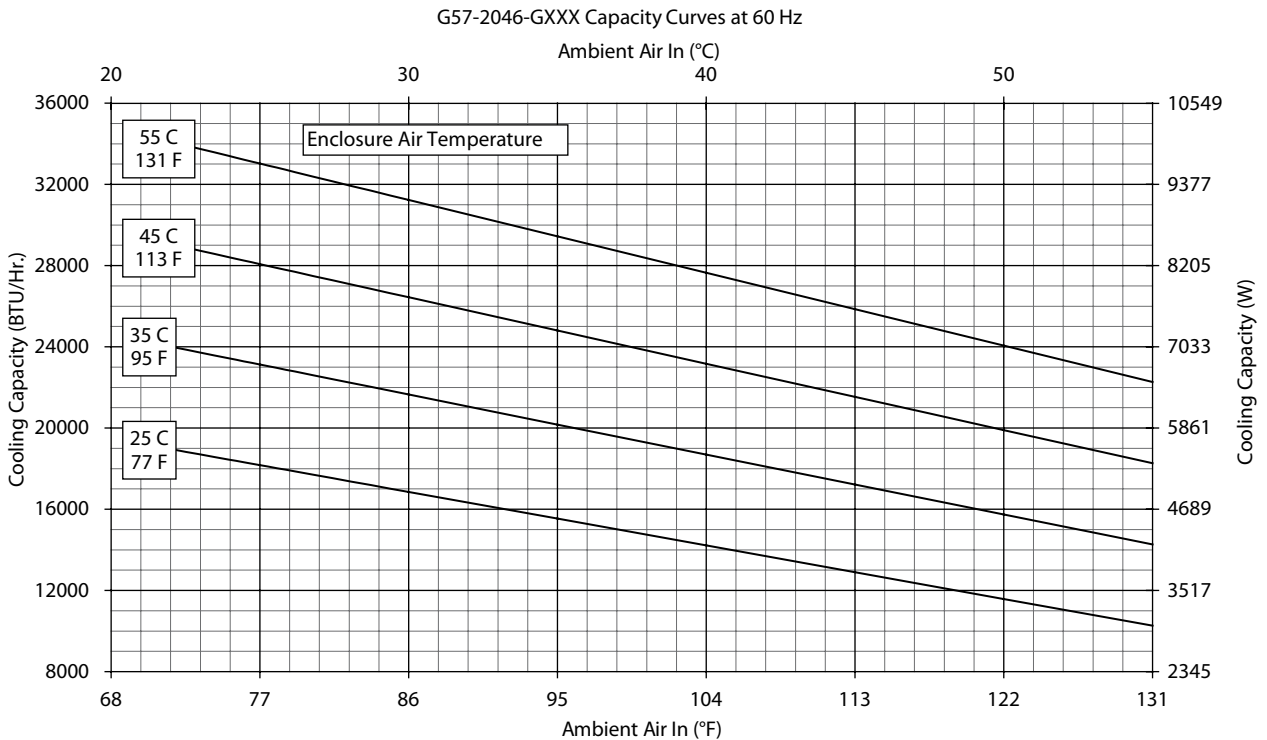
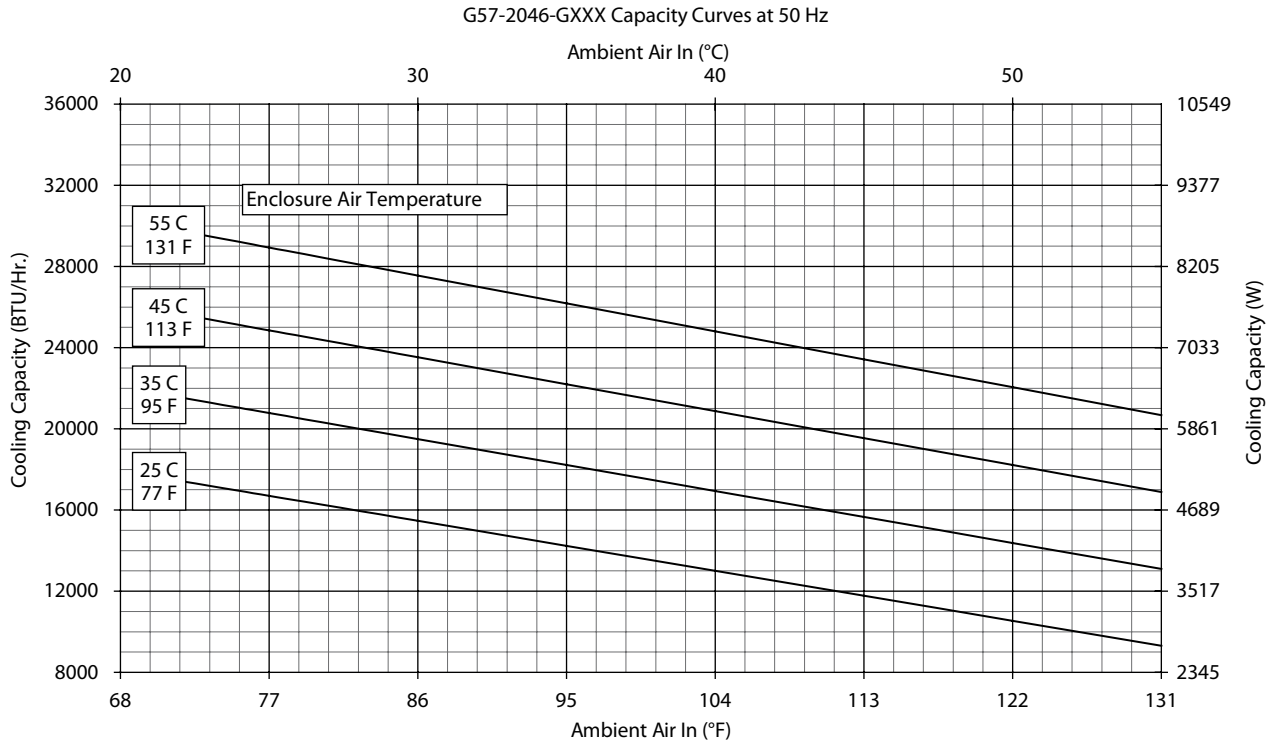

G57 Models 20000 BTU/Hr. (5861 Watt)

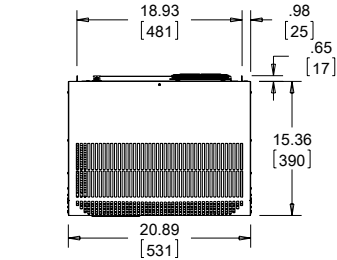

NOTE:
1. MOUNTING GASKET SUPPLIED (NOT SHOWN)
2. UNITS: in. [mm]

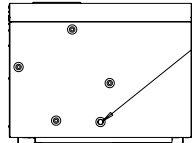
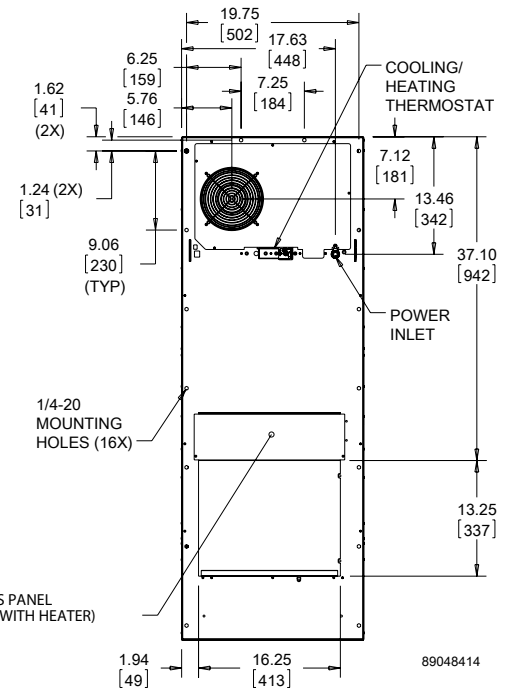
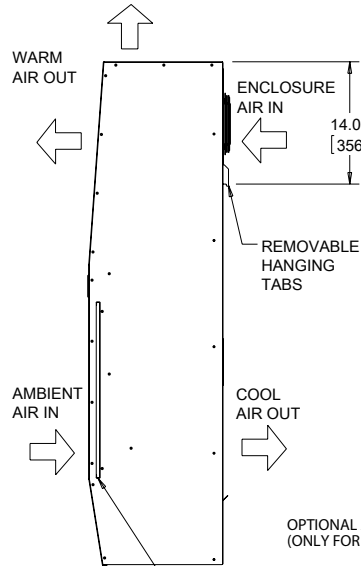
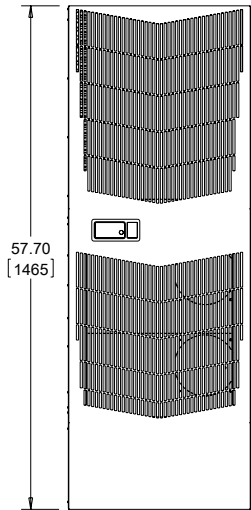

ACCESS HOLE TO .38 [9.5] OUTSIDE DIAMETER DRAIN STUB
CLEANABLE, REUSABLE, ALUMINUM INLET FILTER

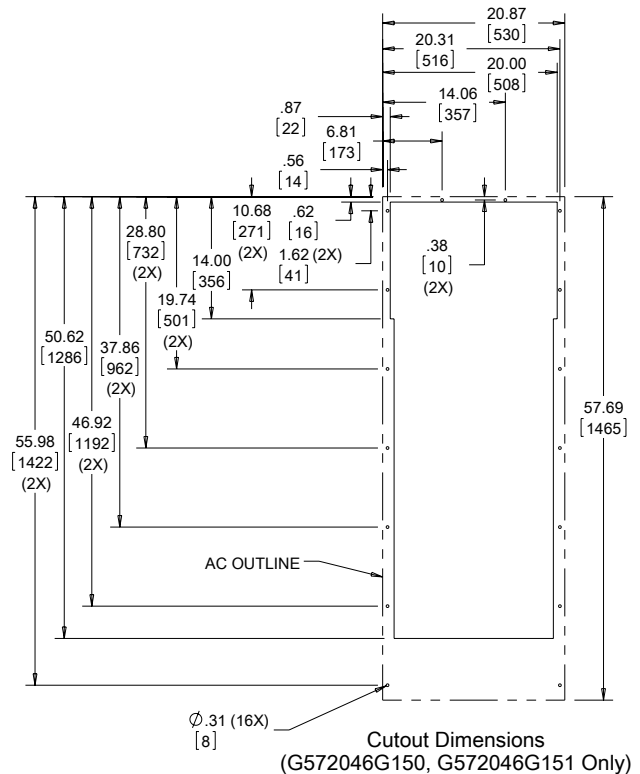
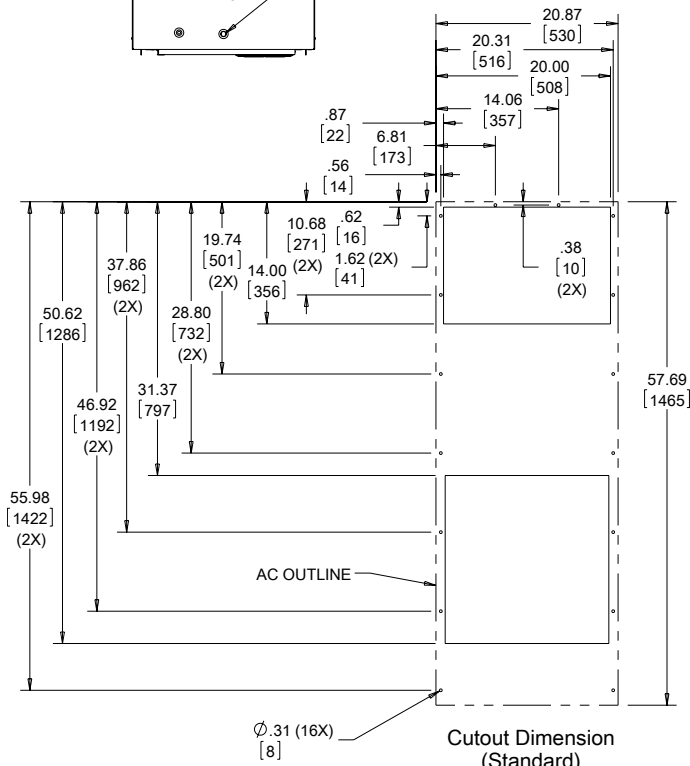

Visit www.nVent.com/HOFFMAN to download 2D and 3D CAD drawings into the overall design of your electrical system.

G57 Models 20000 BTU/Hr. (5861 Watt) With Partial Recess

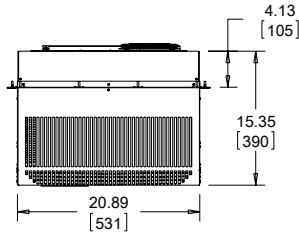

NOTE:
 1. MOUNTING GASKET SUPPLIED (NOT SHOWN)
 2. UNITS: in. [mm]

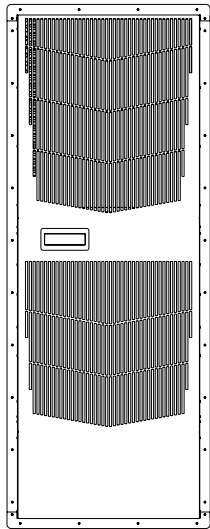

CLEANABLE, REUSABLE, ALUMINUM INLET FILTER

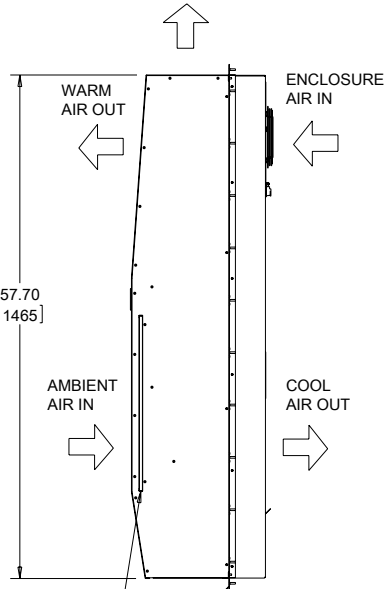

INCLUDED MOUNTING GASKET KIT TO BE ADHERED TO THIS SIDE OF MOUNTING RAILS BEFORE INSTALLING AIR CONDITIONER TO CABINET

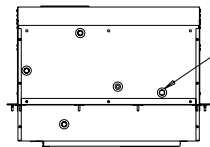
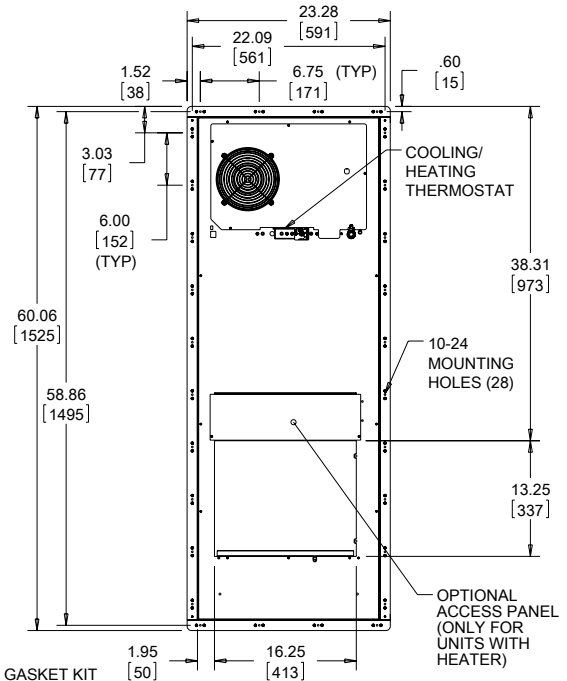

ACCESS HOLE TO .38 [9.5] OUTSIDE DIAMETER DRAIN STUB

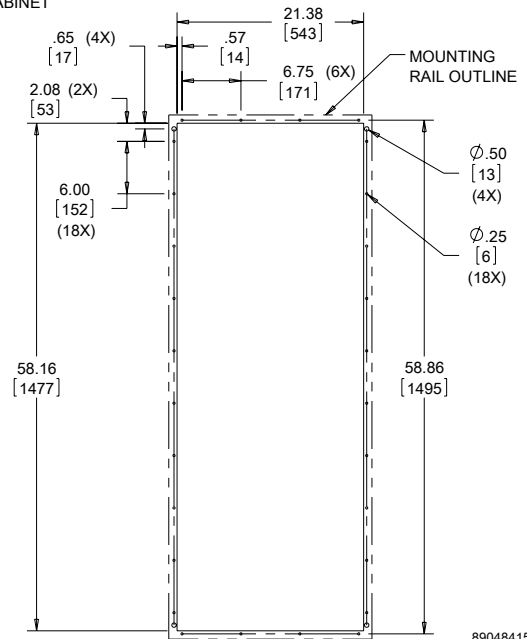

Cutout Dimensions

89048415

Visit www.nVent.com/HOFFMAN to download 2D and 3D CAD drawings into the overall design of your electrical system.

Notes