

## Part Number: D311014

### Electrical Specifications

Frequency Range (GHz):	10.7 - 14.8
Isolation (dB):	20 MIN
Insertion Loss (dB):	0.3 MAX
VSWR:	1.2:1 MIN
Forward Power (W):	10 AVG 50 PK
Reflective Power (W):	2 AVG

### Mechanical/Environmental Specifications

Connector Type:	SMA
Connector Body:	Passivated stainless steel
Connector Pin:	Gold plated copper
Load Body:	Brass
Magnetic Shunt:	Nickel plated CRS
Operational Temp:	-30°C to +65°C
Weight (oz)	0.9 MAX

### D311014 Dimensions

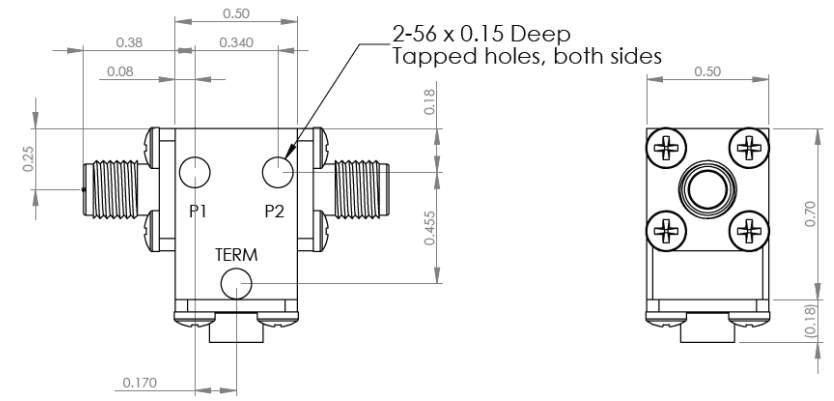

### D311014-3 Dimensions

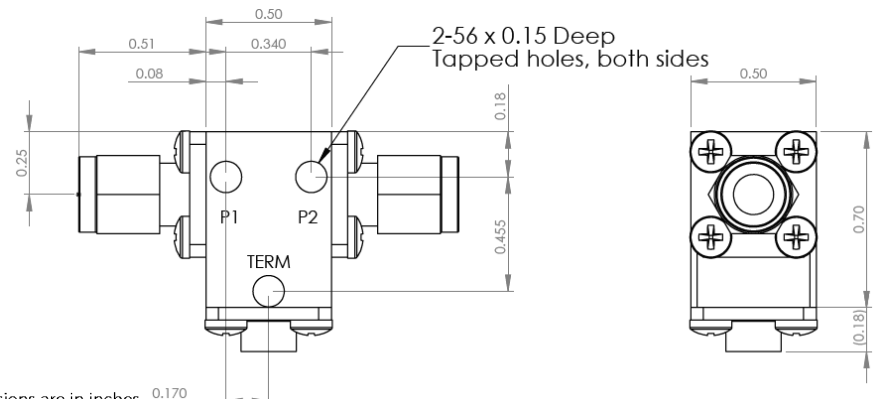

Dimensions are in inches  
Tolerance  
XX ±0.03  
XXX ±0.010

Type of Device	PN Suffix	Connector Configuration Input / Output	PN Example
Single and Dual Junction Isolator, 2-Port Device	N/A	Female / Female	D311014
	-1	Male / Female	D311014-1
	-2	Female / Male	D311014-2
	-3	Male / Male	D311014-3



# MEASURED DATA

Part Number: D3I1014, +25°C

