



SPECIFICATION SHEET

SPECIFICATION SHEET NO.	N0626- KBU151000L150A
DATE	June. 26, 2021
REVISION	A1
DESCRIPTION	Thru Hole Silicon Bridge Rectifier, KBU Series, KBU1510 Type, 4 Pins, Reverse Voltage 1000V Max. Forward Current 15A Max. Operating Temp. Range -55°C ~+150°C, Package in Bulk, 400pcs/Box RoHS/RoHS III compliant
CUSTOMER	
CUSTOMER PART NUMBER	
CROSS REF. PART NUMBER	
ORIGINAL PART NUMBER	MDD KBU1510
PART CODE	KBU151000L150A

VENDOR APPROVE			
Issued/Checked/Approved			
DATE: June 26, 2021			

CUSTOMER APPROVE	
DATE:	

THRU HOLE BRIDGE RECTIFER KBU SERIES

MAIN FEATURE

- The plastic package has Underwrite Laboratory Flammability Classification 94V-0
- Low reverse leakage
- High forward surge current capability
- High temperature soldering guaranteed: 260/10 sec. 0.375" lead length, 5 lbs tension



APPLICATION

- For printed circuit board

RFQ

[Request For Quotation](#)

PART CODE GUIDE

KBU	151000	L	150A
1	2	3	4

- 1) **KBU**: Thru Hole Silicon Bridge Rectifier, KBU Series, 4 Pins
- 2) **151000**: Type code for original part number KBU1510
- 3) **L**: Package code, In Bulk, 400pcs/Box.
- 4) **150A**: Specification code for Reverse Voltage 1000V Max. Forward Current 15A Max

MORE ITEMS AVAILABLE

KBU150050L1505	KBU150100L1510	KBU150200L1520	KBU150400L1540	KBU100600L1060
KBU150800L1580	KBU151000L150A			

THRU HOLE BRIDGE RECTIFIER KBU SERIES

DIMENSION (Unit: Inch/mm)

Image for reference

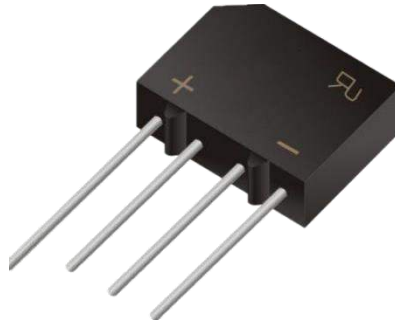

Marking: KBU1510

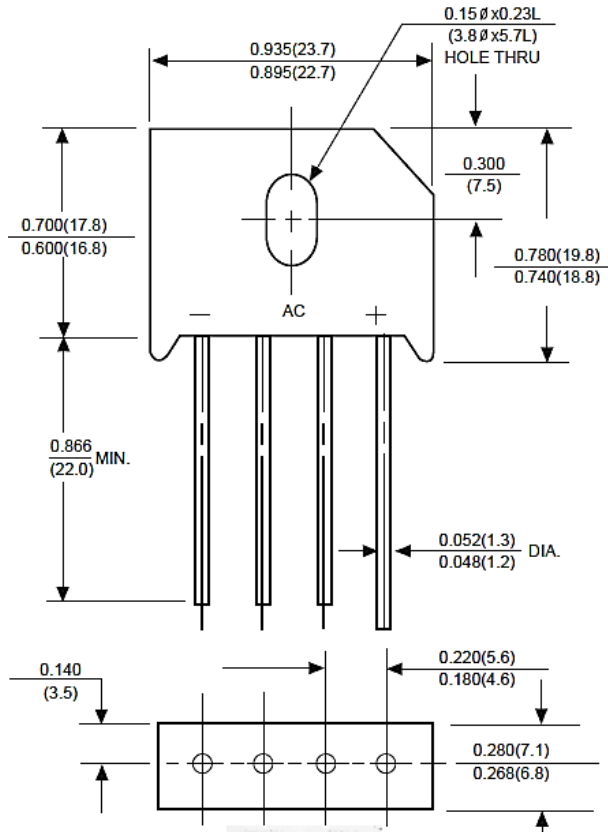

KBU

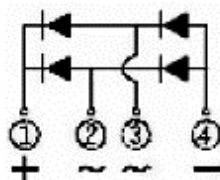

THRU HOLE BRIDGE RECTIFIER KBU SERIES
MECHANICAL DATA

Case	Terminals	Polarity	Mounting Position	Weight per piece
JEDEC KBU molded plastic body	Solder plated, Solderable per MIL-STD-750, Method 2026	Polarity symbol marking on body	Any	0.27 Ounce 7.59 grams

MAX. RATING & CHARACTERISTICS

Parameter	SYMBOLS	VALUE			UNITS
		Min.	Typical	Max.	
Repetitive peak reverse voltage	V _{RRM}			1000	Volts
RMS voltage	V _{RMS}			700	Volts
DC blocking voltage	V _{DC}			1000	Volts
Average forward output rectified current at T _c = 50°C (see Note 2)	I _{AV}			15	A
Peak forward surge current 8.3ms single half sine-wave superimposed on rated load (JEDEC Method)	I _{FSM}		300		A
Rating for Fusing (t<8.3ms)	I ² t		-		A ² S
Forward voltage drop per bridge element at 7.5 A	V _F			1.0	Volts
DC reverse current at rated DC blocking voltage	I _R			10	μA
				0.5	mA
Junction capacitance (Note2)	C _J		-		pF
Thermal resistance (Note 3)	R _{QJA}		-		°C/W
Operating junction temperature range	T _J	-55		+150	
Storage temperature range	T _{STG}	-55		+150	°C

Note

1. Ratings at 25 C ambient temperature unless otherwise specified. Single phase half-wave 60Hz, resistive or inductive load, for capacitive load current derate by 20%.
2. Measured at 1.0MHz and applied reverse voltage of 4.0V
3. Unit mounted on 3.0"*3.0"*0.11" thick(75*75*30mm) at plate
4. PCB mounted with 0.2"*0.2"(12*12mm) copper pads, 0.375" (9.5mm) lead length

THRU HOLE BRIDGE RECTIFIER KBU SERIES
RELIABILITY

Number	Experiment Items	Experiment Method And Conditions	Reference Documents
1	Solder Resistance Test	Test 260°C± 5°C for 10 ± 2 sec. Immerse body into solder 1/16" ± 1/32"	MIL-STD-750D METHOD-2031.2
2	Solderability Test	230°C ±5°C for 5 sec.	MIL-STD-750D METHOD-2026.1 0
3	Pull Test	1 kg in axial lead direction for 10 sec.	MIL-STD-750D METHOD-2036.4
4	Bend Test	0.5Kg Weight Applied To Each Lead, Bending Arcs 90 °C ± 5 °C For 3 Times	MIL-STD-750D METHOD-2036.4
5	High Temperature Reverse Bias Test	TA=100°C for 1000 Hours at VR=80% Rated VR	MIL-STD-750D METHOD-1038.4
6	Forward Operation Life Test	TA=25°C Rated Average Rectified Current	MIL-STD-750D METHOD-1027.3
7	Intermittent Operation Life Test	On state: 5 min with rated IRMS Power Off state: 5 min with Cool Forced Air. On and off for 1000 cycles.	MIL-STD-750D METHOD-1036.3
8	Pressure Cooker Test	15 PSIG, TA=121°C, 4 hours	MIL-S-19500 APPENOIXC
9	Temperature Cycling Test	-55°C~+125°C; 30 Minutes For Dwelled Time 5 minutes for transferred time. Total: 10 cycles.	MIL-STD-750D METHOD-1051.7
10	Thermal Shock Test	0°C for 5 minutes., 100°C for 5minutes, Total: 10 cycles	MIL-STD-750D METHOD-1056.7
11	Forward Surge Test	8.3ms Single Sale Sine-wave One Surge.	MIL-STD-750D METHOD-4066.4
12	Humidity Test	TA=65°C, RH=98% for 1000 hours.	MIL-STD-750D METHOD-1021.3
13	High Temperature Storage life Test	150°C for 1000 Hours	MIL-STD-750D METHOD-1031.5

THRU HOLE BRIDGE RECTIFIER KBU SERIES

RATINGS AND CHARACTERISTIC CURVES (For Reference Only)

FIG.1-MAXIMUM FORWARD SURGE CURRENT

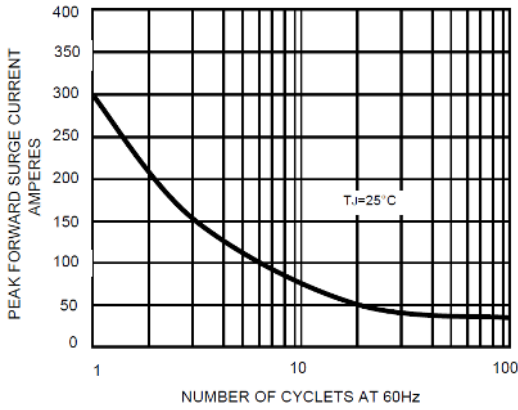

FIG. 2 – DERATING CURVE OUTPUT RECTIFIED CURRENT

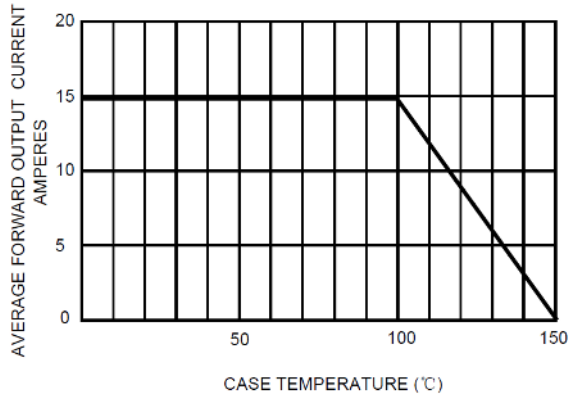

FIG.3– TYPICAL FORWARD CHARACTERISTICS

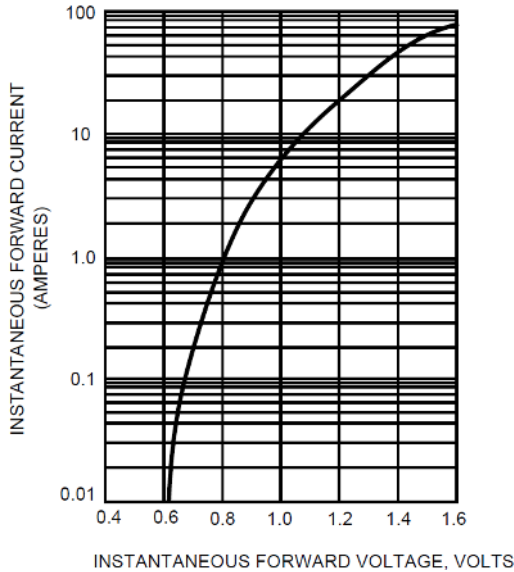
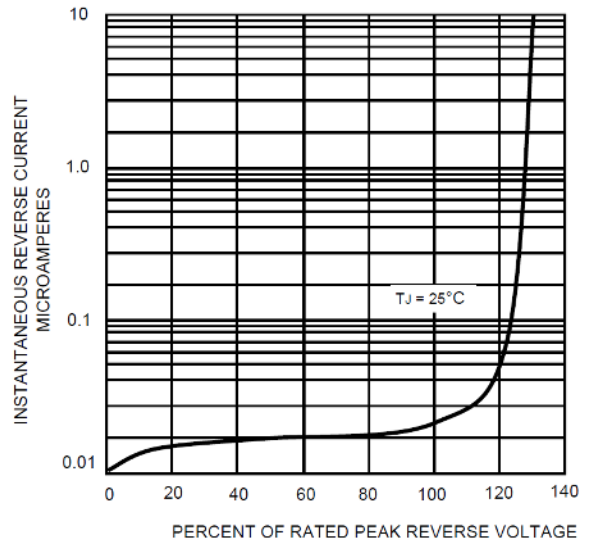

FIG.4– TYPICAL REVERSE CHARACTERISTICS



THRU HOLE BRIDGE RECTIFER KBU SERIES

PACKAGE

Part Type	Qty. Per Box (pcs)	G.W per box (kg)	Inner Box L*W*H (mm)	Carton size L*W*H (mm)	Qty. Per Carton (pcs)	G. W (kg)
KBU	400	2.9	233*213*55	450*250*190	2400	18.25

DISCLAIMER

NextGen Component, Inc. reserves the right to make changes to the product(s) and or information contained herein without notice. No liability is assumed as a result of their use or application. No rights under any patent accompany the sale of any such product(s) or information