

NOTE

- 嵌合相手: 51382-****
MATE WITH: 51382-****
- 偶数極(列)に適用。
APPLY EVEN CIRCUIT PRODUCTS.
- キンクは両外側の位置に付加。
KINK TO BE APPLIED BOTH ENDS.
- 材質
ハウジング: ポリエステル(PBT) UL94V-0
MATERIALS HOUSING: POLYESTER(PBT) UL94V-0
ピン: 黄銅
PIN: BRASS
- めっき
ピン: 錫めっき, リフロー処理(前めっき) めっき厚: 1.0µm MIN.
ニッケル下地めっき, めっき厚: 0.5µm MIN.
FINISHES PIN: PRE-TIN PLATED, (HEAT TREATED MATTE TIN)
PLATING THICKNESS: 1.0µm MIN.
NICKEL UNDERPLATE OVERALL
PLATING THICKNESS: 0.5µm MIN.
- 製品番号 MATERIAL NO.
55935-****

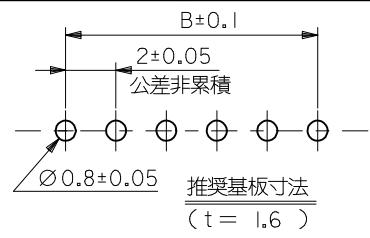

- キャビティ番号及び金型番号
CAVITY NO. AND MOLD No.
- キャビティ番号: 1~2桁の数字
金型番号: アルファベット1文字にて構成
(例 1A, 10B)
尚、金型番号は刻印無しの製品あり。
FORMED BY M AND 1-2 MORE LETTER OF ALPHABET (TO CAVITY No.) AND BY 1 LETTER OF ALPHABET (TO MOLD No.)
(e.g. 1A, 10B)
THERE ARE PRODUCTS WITHOUT THE MARK OF MOLD No.
- トレードマーク: Mプラス1~2文字のアルファベットにて構成。(例: MXJ) 但し、"J"はJAPANを示す。
FORMED BY M AND 1-2 MORE LETTER OF ALPHABET (e.g. MXJ) TO TRADE MARK, BUT "J" SHOW JAPAN.

極数	CIRCUIT SIZE	色	COLOR
30	自然色(白)	NATURAL(WHITE)	
31	黒	BLACK	
32	赤	RED	
33	黄	YELLOW	
34	青	BLUE	
35	桃	PINK	
36	緑	GREEN	
37	茶	BROWN	
38	橙	ORANGE	
39	紫	VIOLET	
51	灰	GRAY	
53	蛍光黄	FLUORESCENT YELLOW	
54	水	PALE BLUE	
55	蛍光桃	FLUORESCENT PINK	
56	黄緑	YELLOWISH GREEN	
58	蛍光橙	FLUORESCENT ORANGE	

31	28	34	55935-15**	15
29	26	32	55935-14**	14
27	24	30	55935-13**	13
25	22	28	55935-12**	12
23	20	26	55935-11**	11
21	18	24	55935-10**	10
19	16	22	55935-09**	9
17	14	20	55935-08**	8
15	12	18	55935-07**	7
13	10	16	55935-06**	6
11	8	14	55935-05**	5
9	6	12	55935-04**	4
7	4	10	55935-03**	3
5	2	8	55935-02**	2
C	B	A	MATERIAL NO. CKT.	

REVISED EC NO.: J2017-0522 DRW: KUSATO 2017/04/11 CHK: DAIDA 2017/04/11 APPR: KANEKO 2017/04/13	GENERAL TOLERANCES (UNLESS SPECIFIED)		DIMENSION STYLE MM ONLY		SCALE ---	DESIGN UNITS METRIC	THIRD ANGLE PROJECTION
	0.25 UNDER	UNDER	±0.03	DRAWN BY T. NIITSU	DATE '02/02/08	TITLE 2.0 W/B SINGLE CONN. PLUG HOUSING ASS'Y R/A -LEAD FREE-	
	0.25 OVER	0.5 UNDER	±0.05	CHECKED BY K. ASAKAWA	DATE '03/06/12	molex MODEL NO.: 55935-**** DOCUMENT NO. SD-55935-002 SHEET NO. 1 OF 2	
	0.5 OVER	1.0 UNDER	±0.1	APPROVED BY T. YAMAGUCHI	DATE '03/06/12		
	1.0 OVER	10 UNDER	±0.2	MATERIAL NO.		SEE CHART	
30 OVER		±0.3	SIZE A3		THIS DRAWING CONTAINS INFORMATION THAT IS PROPRIETARY TO MOLEX ELECTRONIC TECHNOLOGIES, LLC AND SHOULD NOT BE USED WITHOUT WRITTEN PERMISSION		

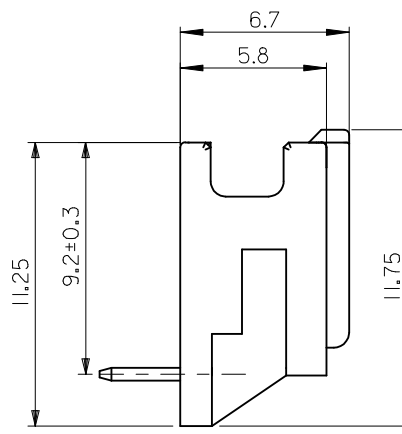
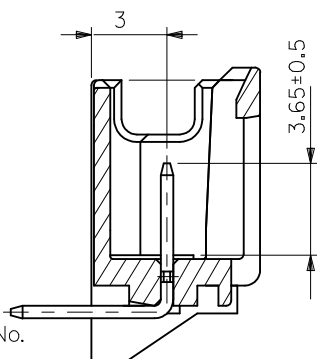
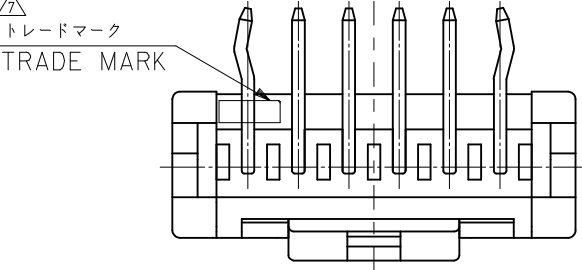
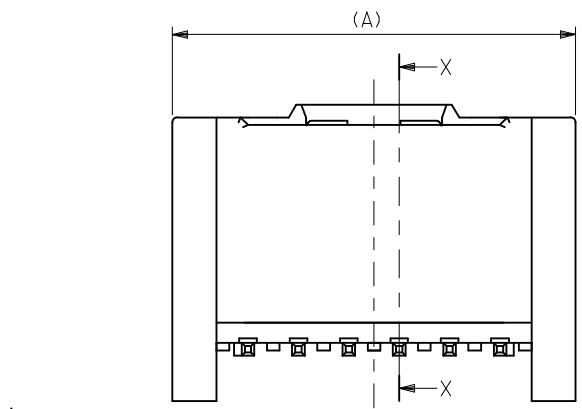
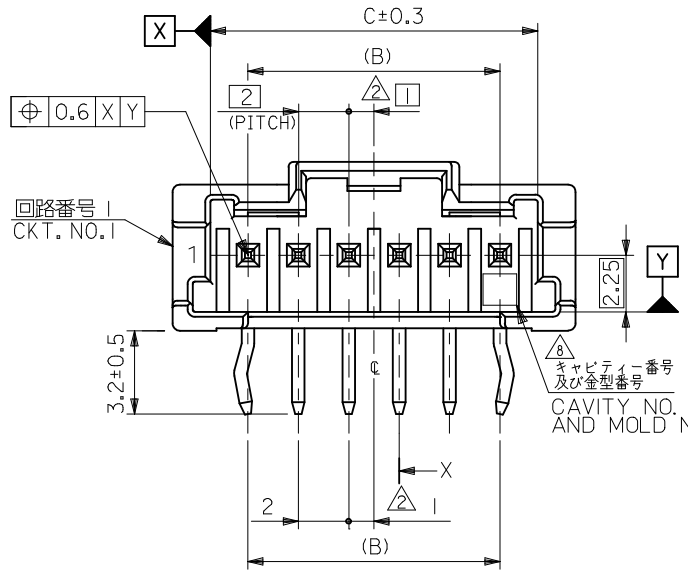

NOTE

- 嵌合相手: 51382-****
MATE WITH: 51382-****
- 偶数極(列)に適用。
APPLY EVEN CIRCUIT PRODUCTS.
- キンクは両外側の位置に付加。
KINK TO BE APPLIED BOTH ENDS.
- 材質
ハウジング: ポリエステル(PBT) UL94V-0
MATERIALS HOUSING: POLYESTER(PBT) UL94V-0
ピン: 黄銅
PIN: BRASS
- めっき
ピン: 錫めっき, リフロー処理(前めっき) めっき厚: 1.0µm MIN.
ニッケル下地めっき, めっき厚: 0.5µm MIN.
FINISHES PIN: PRE-TIN PLATED, (HEAT TREATED MATTE TIN)
PLATING THICKNESS: 1.0µm MIN.
NICKEL UNDERPLATE OVERALL
PLATING THICKNESS: 0.5µm MIN.
- 製品番号 MATERIAL NO.
55935-****

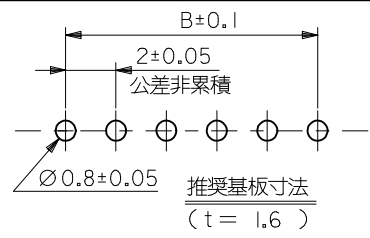

極数 CIRCUIT SIZE

色 COLOR

30	自然色(白)	NATURAL(WHITE)
31	黒	BLACK
32	赤	RED
33	黄	YELLOW
34	青	BLUE
35	桃	PINK
36	緑	GREEN
37	茶	BROWN
38	橙	ORANGE
39	紫	VIOLET
51	灰	GRAY
53	蛍光黄	FLUORESCENT YELLOW
54	水	PALE BLUE
55	蛍光桃	FLUORESCENT PINK
56	黄緑	YELLOWISH GREEN
58	蛍光橙	FLUORESCENT ORANGE

31	28	34	55935-15**	15
29	26	32	55935-14**	14
27	24	30	55935-13**	13
25	22	28	55935-12**	12
23	20	26	55935-11**	11
21	18	24	55935-10**	10
19	16	22	55935-09**	9
17	14	20	55935-08**	8
15	12	18	55935-07**	7
13	10	16	55935-06**	6
11	8	14	55935-05**	5
9	6	12	55935-04**	4
7	4	10	55935-03**	3
5	2	8	55935-02**	2
C	B	A	MATERIAL NO.	CKT.

- トレードマーク: Mプラス1~2文字のアルファベットにて構成。(例:MXJ) 但し, "J"はJAPANを示す。
FORMED BY M AND 1-2 MORE LETTER OF ALPHABET(e.g. MXJ) TO TRADE MARK, BUT "J" SHOW JAPAN.
- キャビティ番号: 1~2桁の数字
金型番号: アルファベット1文字にて構成(例 1A, 10B)
尚、金型番号は刻印無しの製品あり。
AND BY 1 DIGIT TO " DIGIT NUMBERS (TO CAVITY No.) AND BY 1 LETTER OF ALPHABET. (TO MOLD No.) (e.g. 1A,10B)
THERE ARE PRODUCTS WITHOUT THE MARK OF MOLD No.

REVISED EC NO.: J2017-0522 DRW:KUSATO 2017/04/11 CHK:DAIDA 2017/04/11 APPR:TKANEKO 2017/04/13	GENERAL TOLERANCES (UNLESS SPECIFIED)		DIMENSION STYLE MM ONLY		SCALE ---	DESIGN UNITS METRIC	THIRD ANGLE PROJECTION
	0.25 UNDER	UNDER	±0.03	DRAWN BY T.NIITSU	DATE '02/02/08	TITLE 2.0 W/B SINGLE CONN. PLUG HOUSING ASS'Y R/A -LEAD FREE-	
	0.25 OVER	0.5 UNDER	±0.05	CHECKED BY K.ASAKAWA	DATE '03/06/12	molex MODEL NO.: 55935-**** DOCUMENT NO. SD-55935-002 SHEET NO. 1 OF 2	
	0.5 OVER	1.0 UNDER	±0.1	APPROVED BY T.YAMAGUCHI	DATE '03/06/12		
1.0 OVER	10 UNDER	±0.2	MATERIAL NO.		SEE CHART		
30 OVER		±0.3	SIZE A3		THIS DRAWING CONTAINS INFORMATION THAT IS PROPRIETARY TO MOLEX ELECTRONIC TECHNOLOGIES, LLC AND SHOULD NOT BE USED WITHOUT WRITTEN PERMISSION		
ANGULAR		±3 °	DRAFT WHERE APPLICABLE MUST REMAIN WITHIN DIMENSIONS				

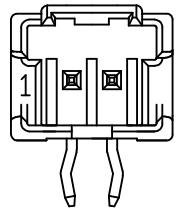
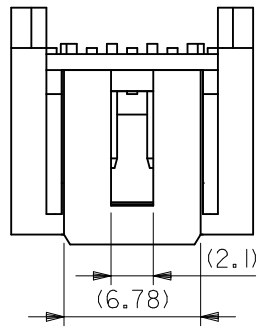
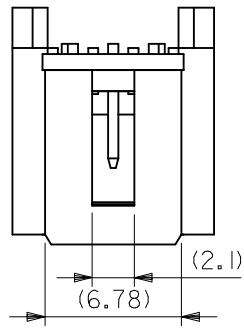
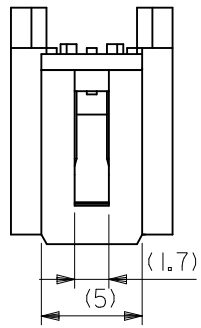

2 CIRCUIT

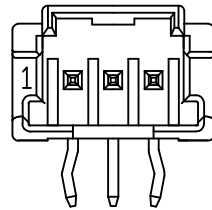

3 CIRCUIT

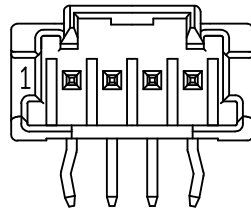

4 CIRCUIT 以上

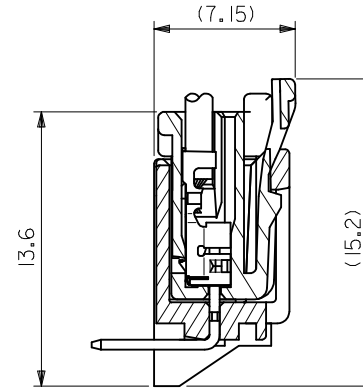

嵌合断面図

MODEL NO. : 55935-****

REVISED EC NO. : J2017-0522 DRW:KUSATO 2017/04/11 CHK:DAIDA 2017/04/11 APPR:KANeko 2017/04/13	GENERAL TOLERANCES (UNLESS SPECIFIED)			DIMENSION STYLE MM ONLY		SCALE ---	DESIGN UNITS METRIC	THIRD ANGLE PROJECTION	
	0.25 UNDER	UNDER	± 0.03	DRAWN BY	DATE	TITLE			
	0.25 OVER	0.5 UNDER	± 0.05	T. NIITSU	'02/02/08	2.0 W/B SINGLE CONN. PLUG HOUSING ASS'Y R/A -LEAD FREE-			
	0.5 OVER	1.0 UNDER	± 0.1	CHECKED BY	DATE				
	1.0 OVER	10 UNDER	± 0.2	K. ASAKAWA	'03/06/12				
	10 OVER	30 UNDER	± 0.25	APPROVED BY	DATE	DOCUMENT NO.		SHEET NO.	
30 OVER		± 0.3	T. YAMAGUCHI	'03/06/12	SD-55935-002		2 OF 2		
ANGULAR	±3 °		MATERIAL NO.		THIS DRAWING CONTAINS INFORMATION THAT IS PROPRIETARY TO MOLEX ELECTRONIC TECHNOLOGIES, LLC AND SHOULD NOT BE USED WITHOUT WRITTEN PERMISSION				
DRAFT WHERE APPLICABLE MUST REMAIN WITHIN DIMENSIONS			SIZE A3						

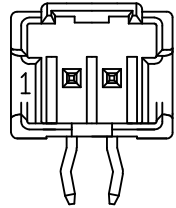
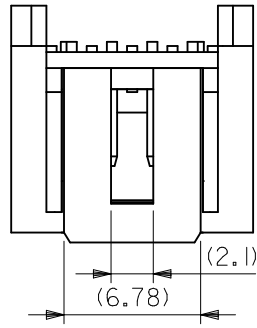
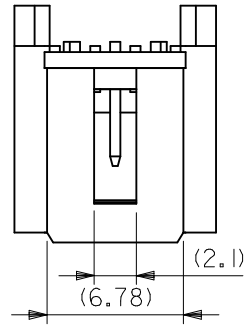
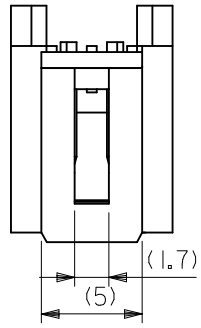

2 CIRCUIT

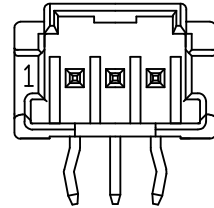

3 CIRCUIT

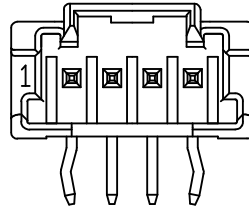

4 CIRCUIT 以上

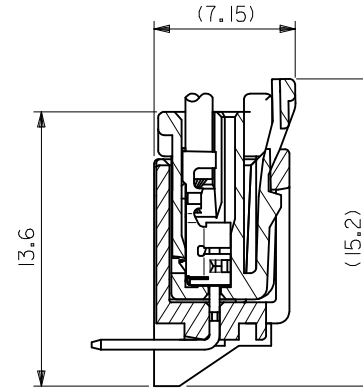

嵌合断面図

MODEL NO. : 55935-****

REVISED EC NO. : J2017-0522 DRW:KUSATO 2017/04/11 CHK:DAIDA 2017/04/11 APPR:KANeko 2017/04/13	GENERAL TOLERANCES (UNLESS SPECIFIED)			DIMENSION STYLE MM ONLY		SCALE ---	DESIGN UNITS METRIC	THIRD ANGLE PROJECTION
	0.25 UNDER	UNDER	± 0.03	DRAWN BY T.NIITSU	DATE '02/02/08	TITLE 2.0 W/B SINGLE CONN. PLUG HOUSING ASS'Y R/A -LEAD FREE-		
	0.25 OVER	0.5 UNDER	± 0.05	CHECKED BY K.ASAKAWA	DATE '03/06/12	molex DOCUMENT NO. SD-55935-002 SHEET NO. 2 OF 2		
	0.5 OVER	1.0 UNDER	± 0.1	APPROVED BY T.YAMAGUCHI	DATE '03/06/12			
	1.0 OVER	10 UNDER	± 0.2	MATERIAL NO.		SEE CHART		
10 OVER	30 UNDER	± 0.25	SIZE A3		THIS DRAWING CONTAINS INFORMATION THAT IS PROPRIETARY TO MOLEX ELECTRONIC TECHNOLOGIES, LLC AND SHOULD NOT BE USED WITHOUT WRITTEN PERMISSION			
30 OVER		± 0.3	DRAFT WHERE APPLICABLE MUST REMAIN WITHIN DIMENSIONS					
ANGULAR	±3 °							