

# T3AWG2152/T3AWG2152-D Data Sheet

## 16-bit Arbitrary/Function Generator

### 2 Analog + 8 Digital Channels



### High-performance Affordable Waveform Generation

- 16-bit vertical resolution ✔ Exceptional detailed waveform generation with high-performance fidelity
- Output voltage and spectral purity ✔ 6 V<sub>pp</sub> at full frequency range and excellent Harmonic Distortion
- Mixed signal generation ✔ Combine two analog channels with 8 synchronized digital channels, ideal for debugging and validating digital design
- Waveform Memory 128 Mpts@Ch ✔ Deep memory for downloading and generating complex pseudo-random both analog and digital waveforms
- Advanced Arbitrary Waveform Generator ✔ 128 Mpts arbitrary waveform depth on each channel  
✔ Up to 16,384 waveform sequencing entries and single point granularity with conditional/unconditional jump, loop, event also remotely programmable.  
✔ Simple and intuitive waveform editor utility for complex analog and digital waveform creation
- Advanced Function Generator ✔ Built-in waveforms include sine, square, pulse, double pulse, ramp, noise, sin(x)/x, gaussian, Lorentz, exponential rise, exponential decay and others
- Specialized for key applications ✔ Transmitter Distortion Test for Automotive Ethernet 100Base-T1 and 1000-Base-T1  
✔ Power and semiconductor dynamic behavior test enabled by the flexible double pulse test capability

Standard warranty is one year.

### Key Specifications

Model	T3AWG2152	T3AWG2152-D
Frequency Range (sinewave waveform)	1 $\mu$ H to 150 MHz	
Vertical Resolution	16 Bits	
Number of Analog Channels	2	2
Number of Digital Channels	n.a.	8
Output Voltage Range (50 $\Omega$ into 50 $\Omega$ )	6 V <sub>pp</sub> @150 MHz	
Waveform Memory	128 Mpts/Ch.	
Sample Rate (not interpolated)	600 MS/s	
Output Source Impedance	5 $\Omega$ and 50 $\Omega$	
Load Impedance @scaling output amplitude	1 $\Omega$ to 1 M $\Omega$	
Output Voltage Load Protection	High Voltage and Low Voltage Limits setting	

# PRODUCT OVERVIEW

## AFG Operational Mode

- Improved Direct Digital Synthesis (DDS) based technology
- Fixed sampling clock



**Arbitrary Function Generation (AFG functionality)**

## AWG Operational Mode

- Variable Clock True-Arbitrary Technology
- Variable Sampling Clock
- Mixed Signal Generation: 2 Analog Channels and 8 Digital Channels

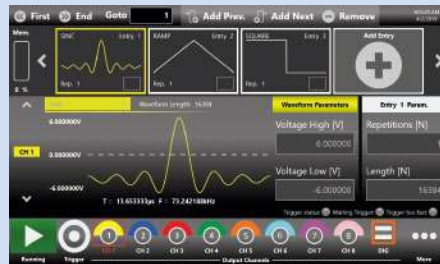

**Arbitrary Waveform Generation (AWG functionality)**

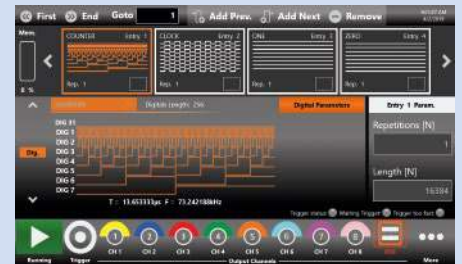

**Digital Pattern Generation (DPG functionality)**

## A multifunctional generator with an innovative architecture

T3AWG2152 and T3AWG2152-D are multifunctional generators that combine many functions in one instrument, including Function Generator, Arbitrary Waveform Generator and Digital Pattern Generator.

These three-different functionalities leverage on the HW flexibility adopting two different technologies.

An improved Direct Digital Synthesis (DDS) based technology adopted when using the Function Generator (AFG) allows the user to change glitch free on-the-fly all the parameters preserving the waveform shape.

All control and settings are always one touch away: swipe gesture to change the channel, the carrier selection and have access to the modulation parameters, swipe into the waveform gallery to import a signal at a glance and use the touch-friendly virtual numeric keyboard to change parameters values.

The variable clock, true-arbitrary technology adopted when using the Arbitrary Waveform (AWG) / Digital Pattern Generator lets the user create complex waveforms of analog and digital pattern, insert them in a sequence, apply loops, jumps and conditional branches. Digital output combined and synchronized with analog output

signals represents an ideal tool to troubleshoot and validate digital design.

The waveform memory length of 128 Mpoints on each channel combined with number of waveforms entries up to 16,384 and the waveform repeat count higher than  $4 \times 10^9$  or infinite make the T3AWG2152 and T3AWG2152-D the best-in-class waveform generators for the most demanding technical applications.

This disruptive and innovative hardware architecture provides the possibility to generate unmatched performance, versatile functionality, outstanding usability, making the TT3AWG2152 and T3AWG2152-D the ideal generator to simplify the job of engineers and researchers.



## Transmitter Distortion Test

### 100Base-T1 and 1000Base-T1 Compliance simplified

Among the compliance tests specified for Automotive Ethernet standard, none is more complex to set up than the transmitter distortion test. Using the T3AWG2152, a Teledyne LeCroy oscilloscope and the QualiPHY Compliance Manager, testing is greatly simplified. Indeed, no access to the Transmitter under test clock (TX\_TCKL) is required and the MATLAB code included in the specification is run directly inside the processing engine of the Teledyne LeCroy oscilloscope, with neither requiring a separate PC. The T3AWG2152's excellent Harmonic Distortion performance, combined with the output voltage amplitude range and the precise tuning of the delay and phase of the differential signal pairs, make the T3AWG2152 a perfect tool for emulating the disturber signal and avoiding the pitfalls that a designer might encounter during the execution of the test.

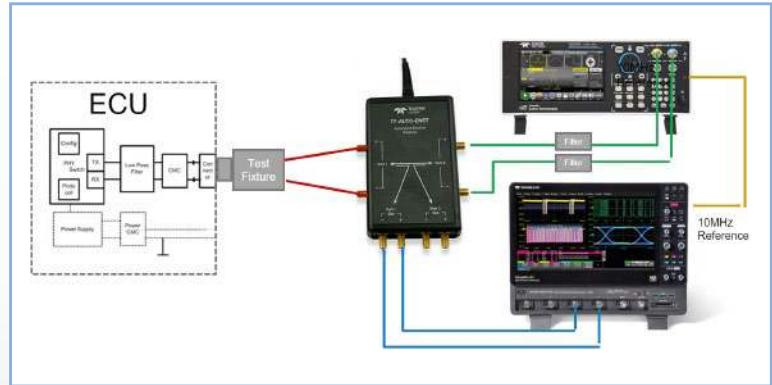

# POWER AND SEMICONDUCTOR TESTING

## Double Pulse Test

### Dynamic behavior of power devices in a minute

The T3AWG2152 and T3AWG2152-D user interface includes the capability of the Double Pulse function required for testing the dynamic behavior of power devices such as MOSFETs and IGBTs. Each of the two pulses can have a different amplitude, rise-time, fall-time and width. This unmatched flexibility of the double pulse test increases the engineer's confidence in their design and enables them to reduce development time with faster and more effective testing. The Double Pulse function is a standard feature of the T3AWG3152 and T3AWG3152-D.

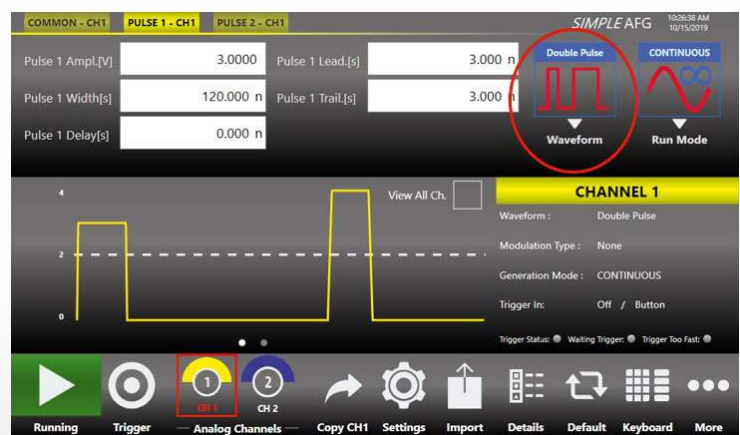

## Arbitrary Waveform Generator – AWG Operating Mode

Generate complex and long signals with multiple waveforms in the sequencer. AWG operating mode uses variable and synchronized sample rate 'True-Arb' technology for applications requiring extremely high signal fidelity. The platform's deep memory enables the capability to store numerous long waveforms.

- 16-bit vertical resolution
- Up to 16,384 waveform entries in the sequencer with loop, conditional/unconditional jump and specified triggered events
- Up to 4G or infinite waveform repeat count
- 128 Mpts arbitrary waveform memory on each channel (standard)
- Waveform granularity is 1 for waveform length >384
- Output impedance 50  $\Omega$  and 5  $\Omega$  selectable
- Variable load impedance selectable

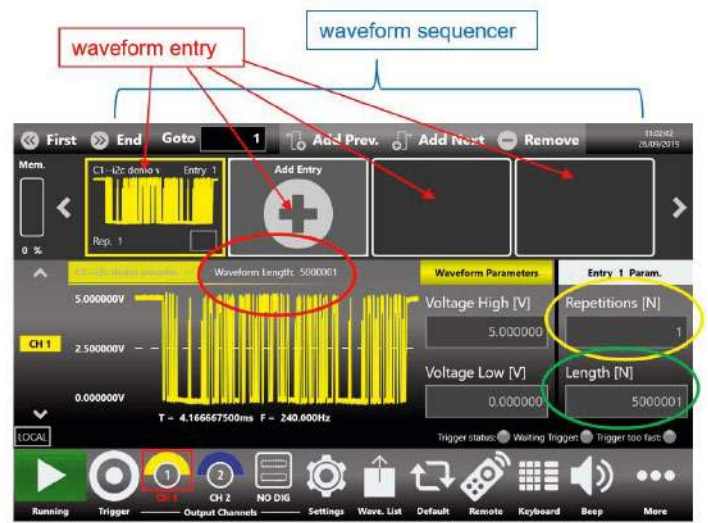

## Waveform Editor Utility

Create and edit both analog and digital complex waveforms and then insert them in the AWG sequencer for signals with a long playtime. Using the waveform editor utility, you will never be intimidated to generate complex signals, on the contrary we will see how easy it can be.

- Create and edit analog and digital waveforms
- Use graphical or tabular format or math formula
- Transfer waveforms directly to the AWG user interface
- Apply filters and add noise

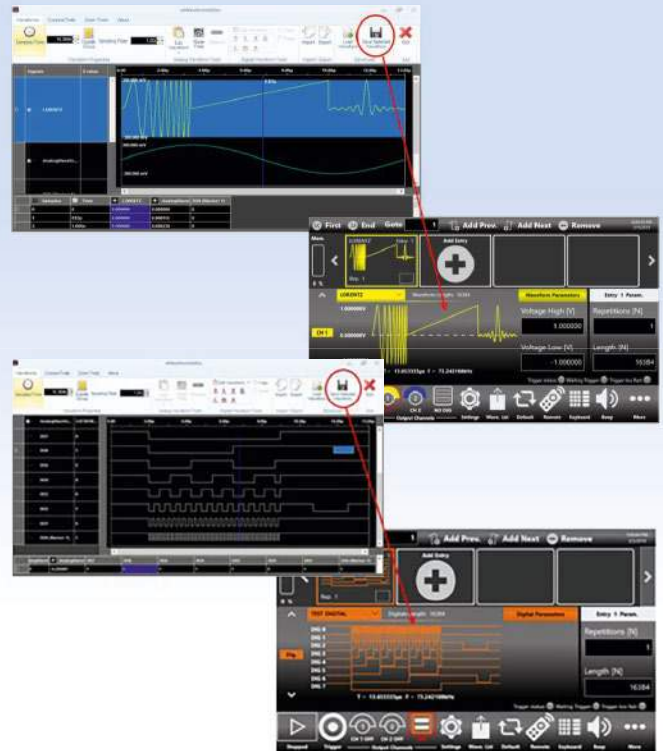



# Arbitrary Function Generator – AFG Operating Mode

Generate a large variety of functions including the traditional ones and more. Change parameters and apply modulations on-the-fly for the output signal. AFG operating mode uses an improved Direct Digital Synthesis (DSS) technology. The Double Pulse function is a standard feature, simplifying the testing of dynamic behavior of power devices.

- 150 MHz sine waveform
- 16-bit vertical resolution, 600 MS/s
- Built-in waveforms include sine, square, pulse, double pulse, ramp, noise, DC,  $\sin(x)/x$ , gaussian, lorentz, exponential rise, exponential decay, haversine and others
- Run modes includes continuous, modulation, sweep and burst
- Modulation modes include AM, FM, PM, PSK, FSK and PWM
- Output impedance 50  $\Omega$  and 5  $\Omega$  selectable
- Variable load impedance selectable



## Emulation of real-world signals

Quickly generate and replicate real-world waveforms captured with an oscilloscope.

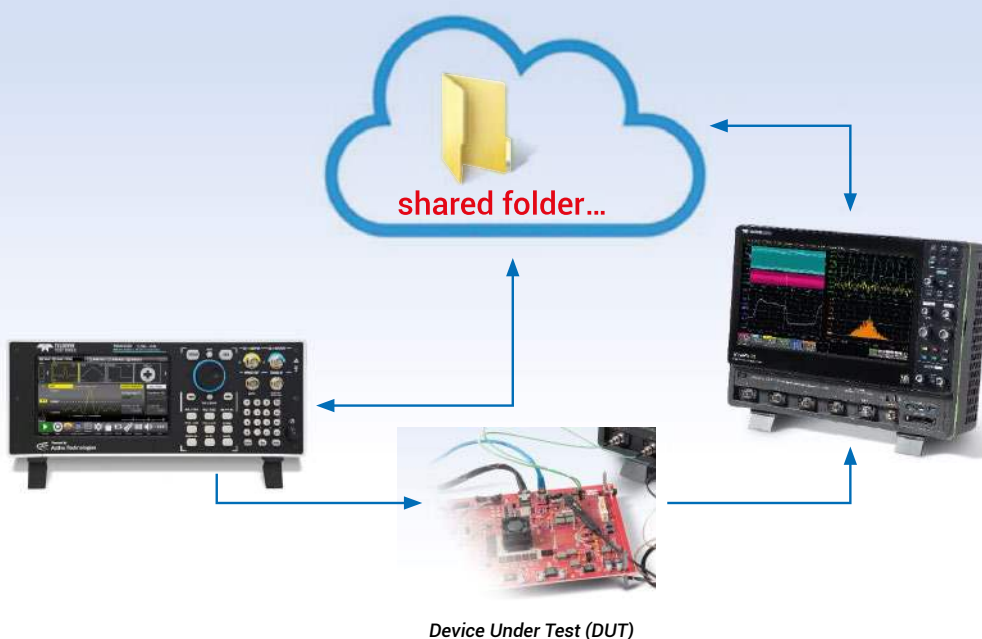

# MODEL SPECIFIC SPECIFICATIONS

## T3AWG2152 and T3AWG2152-D 16-bits high-performance Arbitrary/Function Generator

### General Specifications

	T3AWG2152	T3AWG2152-D
<b>Number of Channels</b>		
Analog	2	2
Digital	0	8
Markers	1	1
<b>Operating Modes</b>		
Function Generator (AFG)	Improved Direct Digital Synthesizer (DDS) based Technology	
Arbitrary Waveform Generator (AWG)	Variable Clock "True Arb" Technology	
<b>Amplitude Voltage Characteristics</b>		
Amplitude Range (50 $\Omega$ into 50 $\Omega$ )	0 to 6 V <sub>pp</sub>	
Amplitude Range (50 $\Omega$ into High-Z)	0 to 12 V <sub>pp</sub>	
Accuracy <sup>1)</sup>	$\pm(1\% \text{ of setting } (V_{pp}) + 5 \text{ mV})$	
Resolution	< 0.5 mV <sub>pp</sub> or 5 digits	
<b>Output Impedance</b>	Single-ended: 50 $\Omega$ and 5 $\Omega$ ( Low Impedance)	
<b>Amplitude DC</b>		
Amplitude Range ( 50 $\Omega$ into 50 $\Omega$ )	-3 V to +3 V	
Amplitude Accuracy	$\pm(1.0\%   \text{ setting }   + 10 \text{ mV})$	

<sup>1)</sup> 1 KHz Sine, 0 V offset, > 5 mVpp amplitude , 50  $\Omega$  load

## AFG Specifications Arbitrary Function Generator Operating Mode

### Waveform Types

	T3AWG2152	T3AWG2152-D
<b>Output Channels</b>		
Connectors	BNC on front panel	
Output Type	Single-ended	
Output Impedance	50 $\Omega$ or 5 $\Omega$ (Low Impedance) selectable	
<b>General Specifications</b>		
Technology	Direct Digital Synthesizer (DDS)	
Standard Waveforms	Sine, Square, Pulse, Double Pulse, Ramp, Noise, DC, Sin(x)/x, Gaussian, Lorentz, Exponential Rise, Exponential Decay, Haversine	
Run Modes	Continuous, Modulation, Sweep, Burst	
Arbitrary Function Waveform Length	<b>16.384 Points</b>	
Internal Trigger Timer		
Range	13.4 ns to 100 s	
Resolution	104 ps	
Accuracy	$\pm(1.1\% \text{ setting } + 5 \text{ ps})$	

# MODEL SPECIFIC SPECIFICATIONS

	T3AWG2152	T3AWG2152-D
<b>Sine Wave Characteristics</b>		
Frequency Range	1 $\mu$ Hz to 150 MHz	
Frequency Resolution	1 $\mu$ Hz or 15 digits	
Output Amplitude (50 $\Omega$ into 50 $\Omega$ ) <sup>2)</sup>	1 $\mu$ H to 150 MHz	6V <sub>pp</sub>
Flatness (1 V <sub>p-p</sub> , relative to 1 KHz)	DC to 150 MHz	$\pm$ 0.5 dB
Harmonic Distortion (1 V <sub>p-p</sub> )	1 $\mu$ Hz to $\leq$ 20 kHz	<-75 dBc
	> 20 kHz to $\leq$ 1 MHz	<-70 dBc
	> 1 MHz to $\leq$ 10 MHz	<-65 dBc
	> 10 MHz to $\leq$ 50 MHz	<-55 dBc
	> 50 MHz to $\leq$ 120 MHz	<-45 dBc
	> 120 MHz to $\leq$ 150 MHz	<-40 dBc
Total Harmonic Distorsion (1 V <sub>p-p</sub> )	10 kHz to 20 KHz	< 0.04 %
Spurious (1 V <sub>p-p</sub> ) <sup>3)</sup>	1 $\mu$ Hz to $\leq$ 10 MHz	<-80 dBc
	> 10 MHz to $\leq$ 150 MHz	<-80 dBc + 6 dBc/octave
Phase Noise (1 V <sub>p-p</sub> , 10 KHz offset)	10 MHz	< -127 dBc/Hz typ.
	100 MHz	< -115 dBc/Hz typ.
<b>Square Wave Characteristics</b>		
Frequency Range	1 $\mu$ Hz to 80 MHz	
Output Amplitude (50 $\Omega$ into 50 $\Omega$ ) <sup>2)</sup>	1 $\mu$ Hz to $\leq$ 150 MHz	6 V <sub>pp</sub>
Frequency Resolution	1 $\mu$ Hz or 15 digits	
Rise/Fall time (10 % to 90 %)	4.0 ns	
Overshoot (1 V <sub>p-p</sub> )	< 1 %	
Jitter (rms)	< 2 ps	
<b>Pulse Wave Characteristics</b>		
Frequency Range	1 $\mu$ Hz to 80 MHz	
Frequency Resolution	1 $\mu$ Hz or 15 digits	
Output Amplitude (50 $\Omega$ into 50 $\Omega$ ) <sup>2)</sup>	1 $\mu$ Hz to $\leq$ 80 MHz	6 V <sub>pp</sub>
Pulse width	5 ns to (Period-5.0 ns)	
Pulse width Resolution	20 ps or 15 digits	
Pulse duty cycle	0 % o 100 % (14 digits, limitations of pulse width apply)	
Leading/trailing edge transition time	4 ns to 1000 ns	
Transition time Resolution	2 ps or 15 digits	
Overshoot (1 V <sub>p-p</sub> )	< 1 %	
Jitter (rms, with rise time and fall time >4 ns)	< 2 ps	
<b>Double Pulse Waves Characteristics</b>		
Frequency Range	1 $\mu$ Hz to $\leq$ 3 MHz	6 V <sub>pp</sub> (over 50 $\Omega$ )
	>3 MHz to $\leq$ 10 MHz	5.5 V <sub>pp</sub> (over 50 $\Omega$ )
	>10 MHz to $\leq$ 50 MHz	5.0 V <sub>pp</sub> (over 50 $\Omega$ )
	where V <sub>pp</sub> = IV <sub>pp1</sub> + IV <sub>pp2</sub> I	
Other Pulse Parameters	same as Pulse Wave	
<b>Ramp Wave Characteristics</b>		
Frequency Range	1 $\mu$ Hz to 5 MHz	
Linearity (<10 KHz, 1 V <sub>p-p</sub> , 100 %)	$\leq$ 0.1 %	
Symmetry	0 % to 100 %	

<sup>2)</sup> Amplitudes double on HiZ load and one channel running at the time

<sup>3)</sup> excluding f<sub>sa</sub>=F<sub>out</sub>, f<sub>sa</sub>=2\*f<sub>out</sub>

# MODEL SPECIFIC SPECIFICATIONS

	T3AWG2152	T3AWG2152-D
<b>Other Waves Characteristics</b>		
Frequency Range		
Exponential Rise, Exponential Decay	1 $\mu$ Hz to 5 MHz	
Sin(x)/x, Gaussian, Lorentz, Haversine	1 $\mu$ Hz to 10 MHz	
Frequency Resolution		
Sin(x)/x	1 $\mu$ Hz or 15 digits	
Gaussian, Lorentz, Exponential Rise, Exponential Decay, Haversine	1 $\mu$ Hz or 14 digits	
Additive Noise		
Bandwidth (-3 dB)	> 150 MHz	
Level	0 V to 6 V-   carrier max value( $V_{pk}$ )	
Resolution	1 mV	
<b>Arbitrary</b>		
Number of Samples	2 to 16.384	
Rise/Fall Time	4.0 ns	
Jitter (rms)	< 2 ps	
Frequency Range	1 $\mu$ Hz to $\leq$ 80 MHz	
Frequency Accuracy		
Non-Arbitrary	$\pm 2\% \times 10^{-6}$ of setting	
Arbitrary	$\pm 2\% \times 10^{-6}$ of setting $\pm 1 \mu$ Hz	

## Modulations

	T3AWG2152	T3AWG2152-D
<b>AM (Amplitude Modulation)</b>		
Carrier Waveforms	Standard Waveforms (except Pulse, DC and Noise) and Arbitrary	
Modulation Source	Internal or External	
Internal Modulating Waveforms	Sine, Square, Ramp, Noise, Arbitrary	
Modulating Frequency		
Internal	500 $\mu$ Hz to 48 MHz	
Depth	0.00 % to 120.00 %	
<b>FM (Frequency Modulation)</b>		
Carrier Waveforms	Standard Waveforms (except Pulse, DC and Noise) and Arbitrary	
Modulation Source	Internal or External	
Internal Modulating Waveforms	Sine, Square, Ramp, Noise, Arbitrary	
Modulating Frequency		
Internal	500 $\mu$ Hz to 48 MHz	
Depth	0.00 % to 120.00 %	
Peak Deviation	DC to 150 MHz	



# MODEL SPECIFIC SPECIFICATIONS

	T3AWG2152	T3AWG2152-D
<b>PM (Pulse Modulation)</b>		
Carrier Waveforms	Standard Waveforms (except Pulse, DC and Noise) and Arbitrary	
Modulation Source	Internal or External	
Internal Modulating Waveforms	Sine, Square, Ramp, Noise, Arbitrary	
Modulating Frequency		
Internal	500 $\mu$ Hz to 48 MHz	
Peak Deviation Range	0° to 360°	
<b>FSK (Frequency Shift Keying)</b>		
Carrier Waveforms	Standard Waveforms (except Pulse, DC and Noise) and Arbitrary	
Modulation Source	Internal or External	
Internal Modulating Waveforms	Square	
FSK Key Rate		
Internal	500 $\mu$ Hz to 48 MHz	
Depth	0.00 % to 120.00 %	
Hop Frequency	1 $\mu$ Hz to 150 MHz	
Number of keys	2	
<b>PSK (Phase Shift Keying)</b>		
Carrier Waveforms	Standard Waveforms (except Pulse, DC and Noise) and Arbitrary	
Modulation Source	Internal or External	
Internal Modulating Waveforms	Square	
PSK Key Rate		
Internal	500 $\mu$ Hz to 48 MHz	
Depth	0.00 % to 120.00 %	
Hop Phase	0° to +360°	
Number of keys	2	
<b>PWM (Pulse Width Modulation )</b>		
Carrier Waveforms	Pulse	
Modulation Source	Internal or External	
Internal Modulating Waveforms	Sine, Square, Ramp, Noise, Arbitrary	
PSK Key Rate		
Internal	500 $\mu$ Hz to 48 MHz	
Deviation Range	0 % to 50 % of pulse period	

# MODEL SPECIFIC SPECIFICATIONS

	T3AWG2152	T3AWG2152-D
<b>Sweep</b>		
Type	Linear, Logarithmic, Staircase and user defined	
Waveforms	Standard Waveforms (except Pulse, DC and Noise) and Arbitrary	
Sweep Time	40 ns to 2000 s	
Hold/Return Times	0 to (2000 s-40 ns)	
Sweep/Hold/Return Time Resolution	20 ns or 12 digits	
Total sweep time accuracy	≤ 0.4 %	
<b>Start/Stop Frequency Range</b>		
Sine	1 μHz to 150 MHz	
Square	1 μHz to 80 MHz	
Trigger Source	Internal/External/Manual	
<b>Burst</b>		
Type	Trigger and Gated	
Waveforms	Standard Waveforms (except Pulse, DC and Noise) and Arbitrary	
Burst Count	1 to 4,294,967,295 cycles or infinite	

## AWG Specifications Variable Clock (True Arbitrary) Operating Mode

	T3AWG2152	T3AWG2152-D
<b>Output Channels</b>		
Connectors	BNC on front panel	
Output Type	Single-ended DC coupled	
Output Impedance	50 Ω or 5 Ω (Low Impedance) selectable	
<b>General Specifications</b>		
Technology	Variable Clock (True Arbitrary)	
Run Modes	Continuous, Triggered Continuous, Single/Burst, Stepped	
Vertical Resolution	16 bits	
Waveform Length	16 to 128 MSamples @Channel	
Waveform Granularity	1 (length > 384), 16 (16 ≤ length ≤ 384)	
Sequence Length	1 to 16384	
Sequence Repeat Counter	1 to 4,294,967,294 or infinite	
<b>Timer</b>		
Range	23.52 ns to 7 s	
Resolution	± 1 sampling clock cycle	
<b>Analog Channel to Channel Skew</b>		
Range	0 to 6.59 μs (depending on internal sampling rate)	
Resolution	1 DAC sampling period	
Accuracy	±(1 %   setting   ± 20 ps)	
Initial Skew	< 200 ps	
<b>Bandwidth</b> calculated: (0.35 / rise or fall time)	> 160 MHz	

# MODEL SPECIFIC SPECIFICATIONS

	T3AWG2152	T3AWG2152-D
<b>Harmonic Distorsion</b> Sine Wave 32 points, 1 V <sub>pp</sub>	< -62 dBc @(600 MS/s and 18.75 MHz)	
<b>Spurious</b> Sine Wave 32 points, 1 V <sub>pp</sub>	< -80 dBc @(600 MS/s and 18.75 MHz)	
<b>SFDR (Spurious Free Dynamic Range)</b> Sine Wave 32 points, 1 V <sub>pp</sub>	< -62 dBc @(600 MS/s and 18.75 MHz)	
<b>Rise/Fall Time</b> 1 V <sub>pp</sub> , single-ended 10 % to 90 %	≤ 2.2 ns	
<b>Overshoot</b> 1 V <sub>pp</sub> , single-ended	< 2 %	

## Time Base and Clock

	T3AWG2152	T3AWG2152-D
<b>Sampling Rate</b>		
Range	1 S/s to 600 MS/s	
Resolution	16 Hz	
Accuracy	± 2.0 x 10 <sup>-6</sup>	
R <sub>j</sub> on clock patter (rms)	< 2 ps	

## Digital Outputs (T3AWG2152-D only)

	T3AWG2152-D
<b>Output Channels</b>	
Connectors	mini-SAS HD connector on rear panel ( not standard pin-out)
Number of connectors	1
Number of Outputs	8 Channels
Output Impedance	100 Ω Differential
Output type	LVDS
Rise/Fall time (10 % to 90 %)	< 1 ns
Jitter (rms)	20 ps
Maximum Update Rate	600 Mbps
Memory Depth	128 MSample @ Ch

# MODEL SPECIFIC SPECIFICATIONS

## Auxiliary input and output characteristics

	T3AWG2152	T3AWG2152-D
<b>Marker Output</b>		
connector type	BNC on Front panel	
Number of connectors	1	
Output impedance	50 $\Omega$	
Output level (into 50 $\Omega$ )		
Amplitude	1 V to 2.5 V	
Resolution	10 mV	
Accuracy	$\pm$ (2 % setting + 10 mV)	
Rise/Fall Ttime (10 % to 90 %, 2.5 V <sub>pp</sub> )	< 700 ps	
Jitter (rms)	20 ps	
Marker out to analog channel skew		
Range	Variable Clock Mode: 0 to 3 $\mu$ s AFG Mode: 0 to 14 s in continuous mode, 0 to 3 $\mu$ s in Trig. Mode	
Resolution	Variable Clock Mode: 78 ps, AFG Mode: 39 ps	
Accuracy	$\pm$ (1 % setting + 140 ps)	
Initial skew	< 1 ns	
<b>Trigger/Gate Input</b>		
Connector type	BNC on the Front Panel	
Input impedance	50 $\Omega$ / 1 K $\Omega$ (programmable)	
Slope/Polarity	Positive or Negative or both	
Input damage level	< -15 V or > +15 V	
Threshold control level	- 10 V to 10 V	
Resolution	10 mV	
Threshold control accuracy	$\pm$ (10 %   setting   + 0.2 V)	
Input voltage swing	0.5 V <sub>p-p</sub> minimum	
Minimum pulse width (1 V <sub>pp</sub> )	3 ns	
Initial trigger/gate delay to Analog Output	Variable Clock Mode: < 131 * DAC clock period +22.5 ns (< 143 * DAC sampling period +22.5 ns with 2x interpolation) AFG Mode: < 400 ns (< 460 ns in triggered sweep mode)	
Trigger in to output jitter	AFG Mode: < 45 ps Variable Clock Mode: 0.29 * DAC clock period	
Maximum frequency	AFG: 65 Mpts on Rising/Falling Edge, 80 MTps on both edges Variable Clock Mode: 42.5 MTps MTps = Mega Transition per second	
<b>Reference clock input</b>		
Connector type	SMA on rear panel	
Input impedance	50 $\Omega$ AC coupled	
Input Voltage range	-4 dBm to 11 dBm sine or square wave (rise time T10-90 <1 ns and duty cycle from 40 % to 60 %)	
Damage level	+14 dBm	
Frequency range	5 MHz to 100 MHz	
<b>Reference clock output</b>		
Connector type	SMA on rear panel	
Output impedance	50 $\Omega$ AC coupled	
Frequency range	10 MHz	
Accuracy	$\pm$ 2.0 x 10 <sup>-6</sup>	
Aging	$\pm$ 1.0 x 10 <sup>-6</sup> /year	
Amplitude	1.65 V	
Jitter (rms)	< 20 ps	

# MODEL SPECIFIC SPECIFICATIONS

	T3AWG2152	T3AWG2152-D
<b>Power</b>		
Source Voltage and Frequency	100 to 240 VAC ±10 % @ 45–66 Hz	
Max Power Consumption	100 W	
<b>Environmental Characteristics</b>		
Temperature (operating)	+5 °C to +40 °C (+41°F to 104 °F)	
Temperature (non operating)	-20 °C to +60 °C (-4 °F to 140 °F)	
Humidity (operating)	5 % to 80 % relative humidity with a maximum wet bulb temperature of 29 °C at or below +40 °C, (upper limit de-rates to 20.6 % relative humidity at +40 °C . Non-condensing.	
Humidity (non-operating)	5 % to 95 % relative humidity with a maximum wet bulb temperature of 40 °C at or below +60 °C, (upper limit de-rates to 29.8 % relative humidity at +60 °C. Non-condensing.	
Altitude (operating)	3,000 meters (9,842 feet) maximum at or below 25 °C	
Altitude (non operating)	12,000 meters (39,370 feet) maximum	
<b>EMC and safety</b>		
Safety	EN61010-1	
Main Standards	EN 61326-1:2013 – Electrical equipment for measurement, control and laboratory use – EMC requirements – Part 1: General requirements	
Immunity	EN 61326-1:2013	

## System specifications

	T3AWG2152	T3AWG2152-D
Display	7 inch, 1024 x 600, capacitive touch LCD	
Operative System	Windows 10	
External Dimensions	W 445 mm – H 135 mm – D 320 mm (3U 10" rackmount)	
Weight	6.25 kg	
Front panel connectors	CH1 and CH2 Outputs (BNC) MARKER N OUT (BNC) TRIGGER IN (BNC) 2 USB 3.0 ports	
Rear panel connectors	Ref. Clk. IN (SMA) Ref. Clk. Out (SMA) External Monitor ports DIGITAL POD A [7..0] 1 USB 2.0 ports or more Ethernet port (10/100/1000BaseT Ethernet, RJ45 port) 2 PS/2 keyboard and mouse ports	
Hard Disk	240 GB SSD or better	
Processor	Intel® Celeron J1900, 2 GHz (or better)	
Processor Memory	4 GB or better	



## T3AWG3-8DIG-TTL LVDS to LVTTTL adapter

(included with T3AWG2152-D)



	T3AWG2151-D
Output Connector	20 position 2.54 mm 2 Row IDC Header
Output Type	LVTTTL
Output Impedance	50 $\Omega$ nominal
Output voltage	0.8 V to 3.8 V programmable in group of 8 bits
Maximum update rate	125 Mbps@0.8 V and 400 Mbps@3.6 V
Dimension	W 52 mm – H 22 mm – D 76 mm
Input connectors	proprietary standard
Cable length	1 meter
Cable type	proprietary standard

## T3AWG3-8DIG-SMA Mini-SAS HD to 16x SMA cable (8 LVDS outputs)

(Accessories to be order separately for the T3AWG3252-D, not included)



	T3AWG3-8DIG-SMA
Output Connector	SMA
Output Type	LVDS
Number of SMA	16 (8 bits)
Cable length	1 meter
Cable type	proprietary standard

## Ordering information

<b>T3AWG2K Series Platforms</b>	<b>Product Code</b>
Function/Arbitrary Waveform Generator, 2 Ch, 150 MHz, 128 Mpts/Ch, 6 V <sub>pp</sub> output, Wave Sequencing	T3AWG2152
Function/Arbitrary Waveform Generator, 2 Ch, 8 Ch Digital, 150 MHz, 128 Mpts/Ch, 6 V <sub>pp</sub> output, Wave Sequencing	T3AWG2152-D
<b>T3AWG2K Series Accessories</b>	<b>Product Code</b>
Mini-SAS HD to 16 x SMA cable (8 LVDS output) only for T3AWG2152-D	T3AWG3-8DIG-SMA
Warranty extension to 3 year for T3AWG2152 and T3AWG2152-D	T3AWG2-W3

Standard warranty is one year.

# ABOUT TELEDYNE TEST TOOLS



## Company Profile

Teledyne LeCroy is a leading provider of oscilloscopes, protocol analyzers and related test and measurement solutions that enable companies across a wide range of industries to design and test electronic devices of all types. Since our founding in 1964, we have focused on creating products that improve productivity by helping engineers resolve design issues faster and more effectively. Oscilloscopes are tools used by designers and engineers to measure and analyze complex electronic signals in order to develop high-performance systems and to validate electronic designs in order to improve time to market.

The Teledyne Test Tools brand extends the Teledyne LeCroy product portfolio with a comprehensive range of test equipment solutions. This new range of products delivers a broad range of quality test solutions that enable engineers to rapidly validate product and design and reduce time-to-market. Designers, engineers and educators rely on Teledyne Test Tools solutions to meet their most challenging needs for testing, education and electronics validation.

## Location and Facilities

Headquartered in Chestnut Ridge, New York, Teledyne Test Tools and Teledyne LeCroy has sales, service and development subsidiaries in the US and throughout Europe and Asia. Teledyne Test Tools and Teledyne LeCroy products are employed across a wide variety of industries, including semiconductor, computer, consumer electronics, education, military/aerospace, automotive/industrial, and telecommunications.

Distributed by:

## Teledyne LeCroy (US Headquarters)

700 Chestnut Ridge Road  
Chestnut Ridge, NY. USA 10977-6499

Phone: 800-553-2769 or 845-425-2000  
Fax Sales: 845-578-5985  
Phone Support: 1-800-553-2769  
Email Sales: [contact.corp@teledynelecroy.com](mailto:contact.corp@teledynelecroy.com)  
Email Support: [support@teledynelecroy.com](mailto:support@teledynelecroy.com)  
Web Site: <http://teledynelecroy.com/>

## Teledyne LeCroy (European Headquarters)

### Teledyne LeCroy GmbH

Im Breitspiel 11c  
D-69126 Heidelberg, Germany

Phone: +49 6221 82700  
Fax: +49 6221 834655  
Phone Service: +49 6221 8270 85  
Phone Support: +49 6221 8270 28  
Email Sales: [contact.gmbh@teledynelecroy.com](mailto:contact.gmbh@teledynelecroy.com)  
Email Service: [service.gmbh@teledynelecroy.com](mailto:service.gmbh@teledynelecroy.com)  
Email Support: [tlc.t3.appsupport.eu@teledyne.com](mailto:tlc.t3.appsupport.eu@teledyne.com)  
Web Site: <http://teledynelecroy.com/germany>

World wide support contacts can be found at:  
<https://teledynelecroy.com/support/contact/#>

[teledynelecroy.com](http://teledynelecroy.com)

