

Instruction Manual

Thank you for purchasing HAKKO FX-951 soldering station.
Please read this manual before operating the HAKKO FX-951.
Keep this manual readily accessible for reference.

1. PACKING LIST AND PART NAMES

Please check to make sure that all items listed below are included in the package.

HAKKO FX-951 soldering station	1	Heat resistant pad	1
HAKKO FM-2027 soldering iron	1	Iron holder	1
Control card	1	Connecting cable	1
Power cord	1	Instruction manual	1
Tip tray	1		

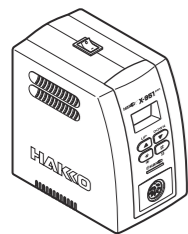

HAKKO FX-951 Soldering station

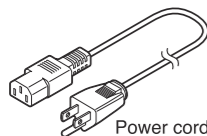

Power cord

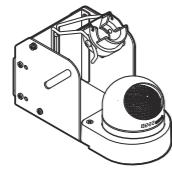

Iron holder

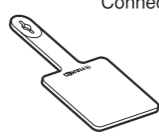

Heat resistant pad

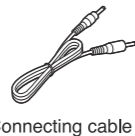

Connecting cable



Tip tray

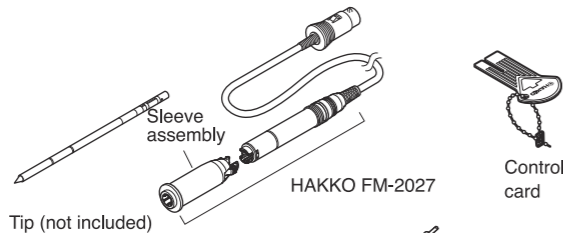

Tip (not included)

HAKKO FM-2027

Control card

2. SPECIFICATIONS

HAKKO FX-951 soldering station

Power consumption	75 W
Temperature range	200-450°C (400-840°F)
Temperature stability	±5°C (±9°F)

● Station

Output	24 V
Dimensions	80 (W) × 130 (H) × 131 (D) mm
Weight	1.2 kg

NOTE:

The temperature was measured using the HAKKO 191 or FG-100 thermometer.
This product is protected against electrostatic discharge.

⚠ CAUTION

This product includes such features as electrically conductive plastic parts and grounding of the handpiece and station as measures to protect the device to be soldered from the effects of static electricity. Be sure to observe the following instructions:

1. The handle and other plastic parts are not insulators, they are conductors. When replacing parts or repairing, take sufficient care not to expose live electrical parts or damage insulation materials.
2. Be sure to ground the unit during use.

Specifications and design are subject to change without notice.

HAKKO CORPORATION

HEAD OFFICE
TEL: +81-6-6561-3225 FAX: +81-6-6561-8466
http://www.hakko.com E-mail: sales@hakko.com

OVERSEAS AFFILIATES

U.S.A.: AMERICAN HAKKO PRODUCTS, INC.
TEL: (661) 294-0090 FAX: (661) 294-0096
Toll Free (800)88-HAKKO

http://www.hakkousa.com

HONG KONG: HAKKO DEVELOPMENT CO., LTD.
TEL: 2811-5588 FAX: 2590-0217
http://www.hakko.com.hk

E-mail: info@hakko.com.hk

SINGAPORE: HAKKO PRODUCTS PTE., LTD.
TEL: 6748-2277 FAX: 6744-0033
http://www.hakko.com.sg

E-mail: sales@hakko.com.sg

Please access to the following address for the other Sales affiliates.

<http://www.hakko.com>

3. WARNINGS, CAUTIONS AND NOTES

⚠ WARNING

Warnings, cautions and notes are placed at critical points in this manual to direct the operator's attention to significant items. They are defined as follows:

⚠ **WARNING:** Failure to comply with a WARNING may result in serious injury or death.

⚠ **CAUTION:** Failure to comply with a CAUTION may result in injury to the operator, or damage to the items involved. Two examples are given below.

NOTE: A NOTE indicates a procedure or point that is important to the process being described.

EXAMPLE: An EXAMPLE is given to demonstrate a particular procedure point or process.

⚠ CAUTION

When power is ON, tip temperatures will be between 200°C and 450°C. (392°F to 840°F.) To avoid injury or damage to personal and items in the work area, observe the following:

- Do not touch the tip or the metal parts near the tip.
- Do not allow the tip to come close to, or touch, flammable materials.
- Inform others in the area that the unit is hot and should not be touched.
- Turn the power off when not in use, or left unattended.
- Turn the power off when changing parts or storing the HAKKO FX-951.
- This appliance is not intended for use by persons (including children) with reduced physical, sensory or mental capabilities, or lack of experience and knowledge, unless they have been given supervision or instruction concerning use of the appliance by a person responsible for their safety.
- Children should be supervised to ensure that they do not play with the appliance.

To prevent accidents or damage to the HAKKO FX-951, be sure to observe the following:

- Do not use the HAKKO FX-951 for applications other than soldering.
- Do not allow the HAKKO FX-951 to become wet, or use it when hands are wet.
- Do not modify the HAKKO FX-951.
- Use only genuine HAKKO replacement parts.
- Do not bend or damage the control card. If the card does become damaged, do not force the card into the station slot.
- Do not strike the iron against hard objects to remove excess solder. This will damage the iron.
- Be sure the work area is well ventilated. Soldering produces smoke.
- While using HAKKO FX-951, don't do anything which may cause bodily harm or physical damage.

4. INITIAL SETUP

A. Iron holder

- Loosen the adjusting screws to change the angle of the iron receptacle as you like, then tighten the screws.

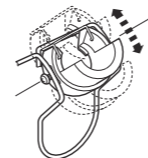

⚠ CAUTION

Do not set up the iron receptacle too high, the temperature of the soldering iron will become very hot.

⚠ CAUTION

Do not lay down the iron receptacle too much, it can be easy to fall down.

- Operation:

First, remove any excess solder from the tip by thrusting the tip into the cleaning wire. (Do not wipe the tip against the wire. This may cause molten solder to spatter.)

When the wire become dirty or loaded with solder, turn the wire until a clean surface is presented. When changing the cleaning wire, lift the case top vertically to prevent solder debris from falling out.

- Place the spare tips in the tip tray.

- Use of the sleep function

When using the sleep function, insert one end of the connecting cable into the jack at the back of the iron holder and the other end into the jack at the back of the soldering station to connect them.

⚠ CAUTION

Be sure to turn off the power before connecting or disconnecting the connecting cable.

B. Handpiece cord assembly

Pass the iron cord through the hole in the heat resistant pad.

C. Soldering station

⚠ CAUTION

Be sure the power switch is OFF before connecting or disconnecting the soldering iron cord. Failure to do so may result in damage to the circuit board.

1. Insert the power cord into the receptacle at the back of the station.
Insert the soldering iron cord into the receptacle at the front of the station.
2. Set the iron in the iron holder.
3. Plug the power cord into a grounded wall socket.

⚠ CAUTION

The HAKKO FX-951 is protected against electrostatic discharge and must be grounded for full efficiency.

5. OPERATION

Controls and displays

Controls

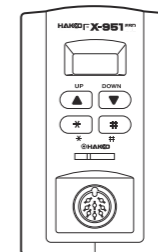

The front panel of the HAKKO FX-951 soldering station has the following controls:

- Four control buttons:

⌘ – Initiates a data entry mode.

* – End of sequence signal (terminates a phase of a data entry mode); when pressed for less than one second, displays settings already stored.

▲ – Increases the value in the appropriate display window.

▼ – Decreases the value in the appropriate display window.

● Operation

1. Turn the power switch ON.
2. Once the temperature is reached, the buzzer sounds. The heater lamp at the lower right of the temperature display [750] starts blinking.

● Setting/changing the temperature

Example: 750°F to 800°F

1. Insert the control card into the slot in the front of the unit.
 - The hundreds digit will begin to flash, indicating that the unit is in the TEMPERATURE SET mode and data may be entered.
2. Entering the hundreds digit
 - Press the ▲ or ▼ button to set the desired figure. Only 2, 3, or 4 can be selected. (In °F mode, 4, 5, 6, 7, or 8 can be selected). When the desired figure is displayed, press the * button to enter. The tens digit will begin to flash.
3. Entering the tens digit
 - Press the ▲ or ▼ button to set the desired figure. Any value from 0 to 9 can be selected. (In °F mode, the same value can be selected.) When the desired figure is displayed, press the * button to enter. The units digit will begin to flash.
4. Entering the units digit
 - Press the ▲ or ▼ button to set the desired figure. Any value from 0 to 9 can be selected. (In °F mode, the same value can be selected.) When the desired figure is displayed, press the * button to enter. The desired temperature is now entered into the system memory and heater control will begin.

When the station is ON and the card is in the station, the data entry procedure follows:

Displays

The HAKKO FX-951 has a three-digit display element. Depending upon the selected mode, it will display:

- Normal mode: Sensor temperature (tip temperature)
- Data entry: Selected quantity (See 'data entry procedures' for exact characteristics.)
- Temperature scale: °C or °F, depending upon selection
- Error detection: Refer to 'ERROR MESSAGES' section.

In addition, heater lamps will flash when the station has reached the desired temperature, indicating that it is ready for use.

An audible buzzer is provided to alert the operator when:

- The station has reached the set temperature. The buzzer will sound once.
- When the low temperature threshold has been crossed, the buzzer will sound continuously. This buzzer will shut off when the sensed temperature returns to the acceptable range.
- When a foreign substance, an incompatible tip, or the soldering end of the tip is inserted into the HAKKO FM-2027, the display will blink and the buzzer will sound continuously.
- When the error occurs with the HAKKO FM-2027, the buzzer will sound continuously.

NOTE:

The buzzer that sounds when the unit reaches the desired temperature, or when C-E or S-E is displayed, can be switched on or off via the parameter settings.

⚠ CAUTION

The HAKKO FX-951 is preset at 750°F at the factory. Check the temperature setting by pressing the * button. The set temperature will be displayed for two seconds.

⚠ CAUTION

Place the iron in the iron holder when not in use.

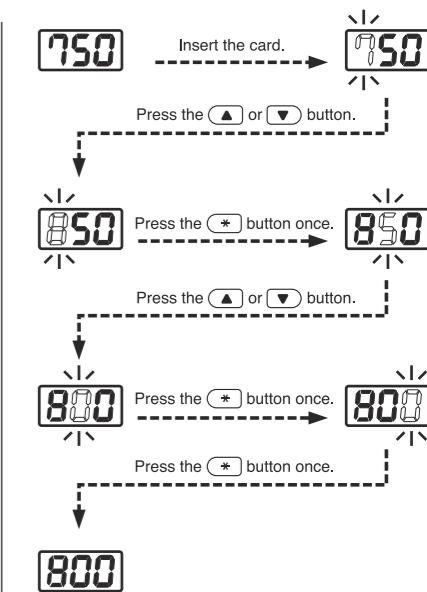

NOTE:

If power is switched off or lost during the execution of this procedure, no data will be entered. The entire procedure must be repeated from step 1.

1. Hold the * button down for at least one second. The current temperature setting will be displayed, then the hundreds digit will begin to flash. This indicates that the station has entered the temperature setting mode. Continue with the procedure of 2 - 4, above.
2. When the * button is pressed for less than one second, the current temperature setting is displayed for two seconds, then returns to show the actual tip temperatures.

5. OPERATION

● Replacing the tip

⚠ CAUTION

The tip may be hot. Avoid holding the hot tip for a long time even if using the heat-resistant pad. Otherwise burns may result.

Removing the tip:

- Hold down the lock release buttons in the sleeve assembly, pull out the tip together with the sleeve assembly from the connector.

⚠ CAUTION

- Be sure to keep the lock release buttons hold down while pulling out the sleeve assembly. Failure to do so will damage the locking mechanism.
- Be sure to pull out the tip only after separating the sleeve assembly from the connector. Otherwise, the sleeve assembly may fall down and break.

- Holding the front end of the sleeve assembly, pull out the tip.

Inserting the tip:

Holding the front end of the tip, insert it into the sleeve assembly.

⚠ CAUTION

Insert the tip into the sleeve assembly until it clicks into place. When you hear it clicks, avoid forcing the tip into the sleeve assembly.

- Insert the tip securely into the connector.

NOTE:

Improper insertion of the tip will cause [S-E] to appear on the display.

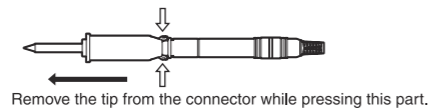

Remove the tip from the connector while pressing this part.

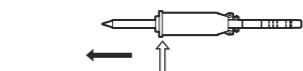

Hold the front part of the sleeve assembly to remove the tip.



Hold this part to insert the tip into the sleeve assembly.

⚠ CAUTION

When holding the head of the tip, there is a danger of burn. Be sure to use the heat-resistant pad.



Hold this part to insert the tip into the connector.

The temperature accuracy of iron tips is $\pm 15^{\circ}\text{C}$ ($\pm 27^{\circ}\text{F}$) except for some tips.

If a higher temperature accuracy is required, use the following offset function:

● How to enter the tip offset value into the HAKKO FX-951

Example 1;

If the measured temperature is 710°F and the set temperature is 700°F , the difference is -10°F (need to decrease by 10°F). So, enter the figure which 10 is deducted from present offset value.

1. Insert the control card into the slot in the station.

- The station is in the temperature setting mode. The hundreds digit will begin to flash.

2. Press the [M] button on the front panel.

- This will set the station to offset value entry mode.

3. Enter the offset value

The allowable ranges for offset values are from -50 to $+50^{\circ}\text{C}$ (In $^{\circ}\text{F}$ mode from -90 to $+90^{\circ}\text{F}$).

NOTE:

During offset data entry mode with blinking, the tip temperature is controlled by present offset value.

a. Entering the hundreds digit

- Press the [▲] or [▼] button to set the desired figure. Only 0 (plus) or - (minus) can be selected. (In $^{\circ}\text{F}$ mode, it is the same as $^{\circ}\text{C}$ mode). When the 0 (plus) or - (minus) is selected, press the [*] button to enter. The tens digit will begin to flash.

b. Entering the tens digit

- Press the [▲] or [▼] button to set the desired figure. Any value from 0 to 5 (In $^{\circ}\text{F}$ mode, 0 to 9) can be selected. When the desired figure is displayed, press the [*] button to enter. The units digit will begin to flash.

c. Entering the units digit

- Press the [▲] or [▼] button to set the desired figure. Any value from 0 to 9 (In $^{\circ}\text{F}$ mode, same value can be selected.) When the desired figure is displayed, press the [*] button to enter. The desired temperature is now entered into the system memory and heater control will begin with new offset value.

When the station is ON and the card is in the station, the offset entry procedure follows:

- Hold the [M] button down for at least one second. The current offset value will be displayed, then the hundreds digit will begin to flash. This indicates that the station has entered the offset value input mode. Continue with the procedure of a - c, above.

- When the [M] button is pressed for less than one second, the current offset value is displayed for two seconds, then returns to tip temperature.

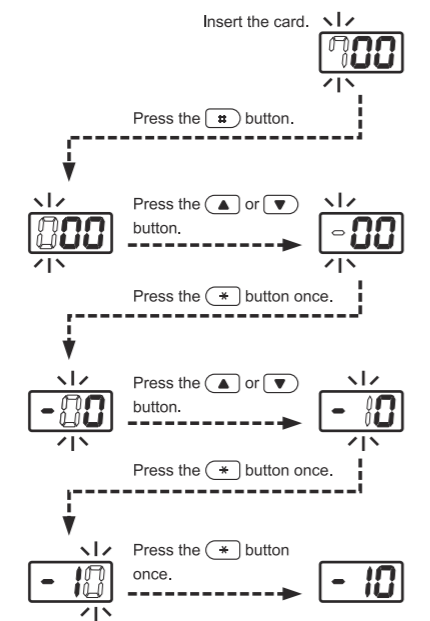

NOTE:

When the unit is in offset-free mode, you can go into the offset value entry mode without control card by pressing the [M] button for second.

6. PARAMETER SETTINGS

The HAKKO FX-951 comes from the factory with the following values preset.

Temperature scale	Fahrenheit
Power save	0 min.
Low temperature alarm setting	300°F
Resetting the supervisor or operator control setting	4 0
Setting temperature	750°F
Buzzer setting (C-E sound, S-E sound)	ON
Buzzer setting (Set temperature alert)	ON

● Entering the parameter

1 $^{\circ}\text{C}$ or $^{\circ}\text{F}$ temperature display

2 Power save setting

Set the time from the placement of the soldering iron on the iron holder to the activation of the sleep function.

NOTE:

When not using the power save function, do not connect the iron holder and the soldering station with the connecting cable.

Power save example:

- 0 Sleep (immediately after the soldering iron is placed on the iron holder)
- 10 Sleep (10 minutes after the soldering iron is placed on the iron holder)
- 20 Auto-power shutoff (30 minutes after the soldering iron is placed on the iron holder)

NOTE:

The power save time can be set in steps of one minute (30 minutes max.)

- When the sleep function is activated, the temperature of the tip begins to drop.
- When the display shows [SLP], pressing any button the power will be turned on again.

NOTE:

The sleep function does not work in case the setting temperature is less than $300^{\circ}\text{C}/570^{\circ}\text{F}$.

- When the auto-power shutoff function is activated and power to the heater is shut off, the buzzer sounds three times.
- When the display shows [---], and to begin soldering, cycle the power switch OFF, then ON.

3 Resetting the low temperature alarm tolerance setting

The unique function alerts the operator when the sensed temperature drops below a set limit. Should this occur, an error message will be displayed, and the buzzer will sound continuously. When the temperature returns within the allowable range, the buzzer will stop.

Range of allowable low temperature alarm tolerance for $^{\circ}\text{C}$: $30 - 150^{\circ}\text{C}$
for $^{\circ}\text{F}$: $60 - 300^{\circ}\text{F}$

Example:

When the setting temperature is 350°C and the low temperature alarm tolerance is 100°C , buzzer will sound when the tip temperature will drop over 250°C .

4 Resetting the supervisor/operator control setting

The HAKKO FX-951 has the following six parameters:

- $^{\circ}\text{C}$ or $^{\circ}\text{F}$ temperature display selection
- Power save
- Low temperature alarm setting
- Resetting the supervisor/operator control setting
- Buzzer setting (C-E sound, S-E sound)
- Buzzer setting (Set temperature alert)

Once the station enters parameter mode, set the parameters in the order shown below. After all the parameters have been set, normal operation will be resumed.

- Turn power OFF.
- Insert the control card into the card slot in the front of the unit.
- Press and hold down the [▲] and [▼] buttons simultaneously, and then turn power ON.
- Hold [▲] and [▼] buttons down until the display shows [iC] (Celsius) or [iF] (Fahrenheit).

- When either the display shows either [iC] or [iF] the station is in parameter input mode.
- Pressing either the [▲] and [▼] button will cause the display to alternate between [iC] or [iF].
- When the desired scale is displayed, select by pressing the [*] button. The system will automatically sequence to power save mode.

When the station enters the parameter input mode, the procedure is as follows.

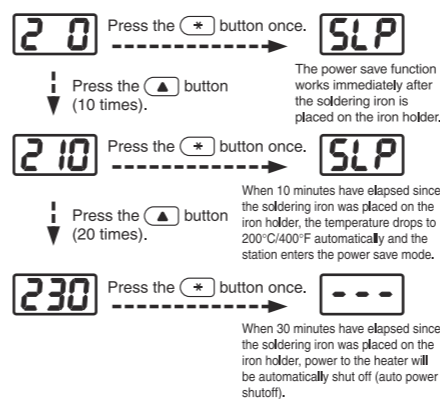

- When the station enters low-temperature alarm tolerance setting mode, the hundreds digit begins flashing. Enter and store the value in the same manner as described in "Changing the temperature setting."

- If you enter a value exceeding the allowable range shown to the left, you will be brought back to entering a value in the hundreds digit. If this occurs, reenter a correct value.

- Once the value is stored, the system will automatically sequence to resetting the supervisor/operator control setting mode.

To change the supervisor/operator control settings, the procedure is as follows.

- The display will show [40] or [4i] when this mode is entered.

[40]: No offset value can be entered without inserting the card.

[4i]: An offset value can be entered without inserting the card.

Pressing the [▲] or [▼] button will change [40] and [4i].

When the desired setting is displayed, select by pressing [*] button.

5 Buzzer setting (C-E sound, S-E sound)

- In the buzzer sound setting mode, which sets whether to sound the buzzer when a sensor error or soldering iron error occurs, either [50] or [5i] is displayed.

[50]: The buzzer does not sound.

[5i]: The buzzer sounds.

Select [▲] or [▼] and press the [*] button.

6 Buzzer setting (Set temperature alert)

- In the set temperature alert setting mode, either [60] or [6i] is displayed.

[60]: The buzzer does not sound.

[6i]: The buzzer sounds.

Select [▲] or [▼] and press the [*] button.

The system will exit the parameter setting mode and begin heater control. It is now ready for normal operation.

7. ERROR MESSAGES

● Sensor Error



When there is the possibility that a failure has occurred in the sensor or heater (including the sensor circuit), [S-E] is displayed and the power is shut down.

⚠ CAUTION

The sensor error also occurs if the tip is not inserted properly.

● Low-temperature alarm tolerance error

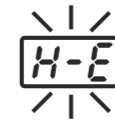

If the sensor temperature falls below the difference between the current temperature setting and the low-temperature alarm tolerance, [H-E] is displayed and the warning buzzer sounds. When the tip temperature rises to a value within the set tolerance, the buzzer will stop sounding.

EXAMPLE:

Assume that the temperature setting is $400^{\circ}\text{C}/750^{\circ}\text{F}$ and the tolerance $50^{\circ}\text{C}/100^{\circ}\text{F}$. If the temperature continues to decrease and finally falls below the value indicated below while the heating element is on, the displayed value starts blinking to indicate that the tip temperature has dropped.

● Heater terminal short-circuit error



[HSE] will flash, and the buzzer will sound continuously, when the tip is inserted wrong way round, an incompatible tip is inserted, or a foreign object has found its way into the connector.

● Soldering iron error

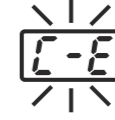

[C-E] will be displayed if the connector cord is not attached to the station OR the wrong soldering iron is connected.

※ 各言語（日本語、英語、中国語、フランス語、ドイツ語、韓国語）の取扱説明書は以下のURL、HAKKO Document Portalからダウンロードしてご覧いただけます。
（商品によっては設定の無い言語がありますが、ご了承ください）
* 各言語（日本語、英語、中文、法語、ドイツ語、韓国語）の使用説明書は以下のURL、HAKKO Document Portalからダウンロードしてください。
（有一部分の製品は設定の無い言語に対応していません）
* Instruction manual for the language, Japanese, English, Chinese, French, German and Korean can be downloaded from the following URL, HAKKO Document Portal.
(Please note that some language may not be available depending on the product.)

<https://doc.hakko.com>

1. PARTS LIST

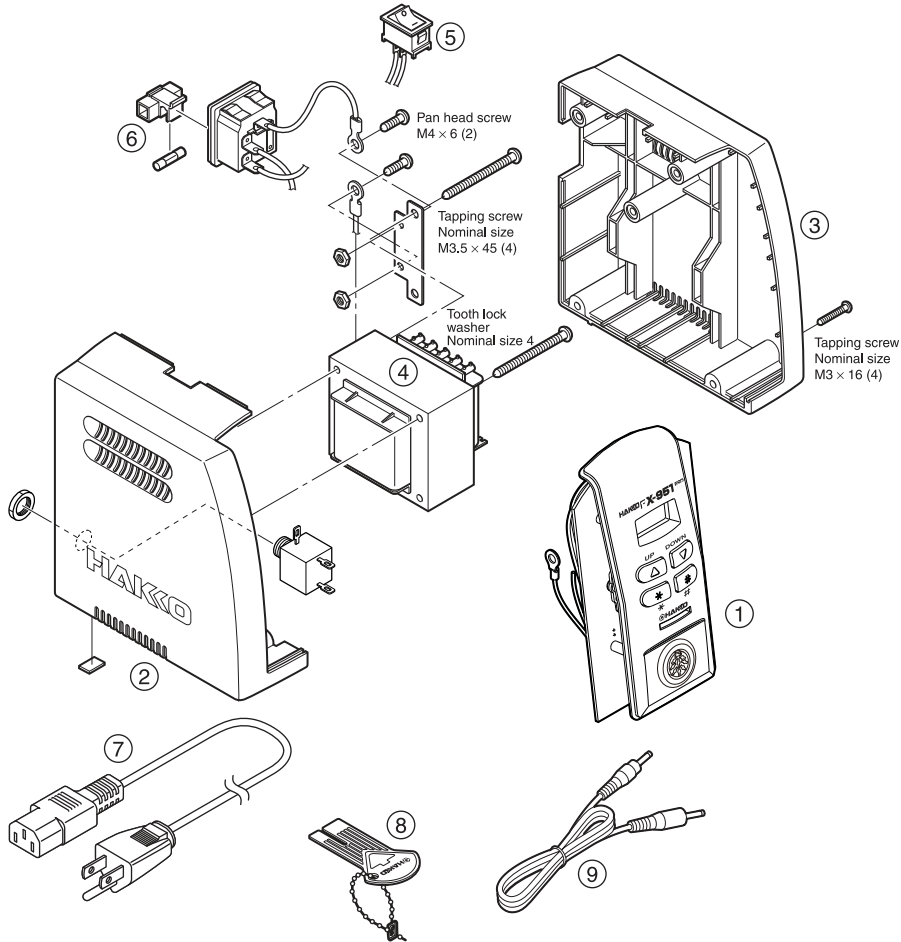

● HAKKO FX-951 Station

Item No.	Part No.	Part Name	Specifications
①	B3732	Front panel assy.	
②	B3255	Case/Left	With rubber feet
③	B2978	Case/Right	With rubber feet
④	B2979	Transformer	100V
	B2983	Transformer	110V
	B2836	Transformer	120V
	B2984	Transformer	220V
	B2985	Transformer	230V
	B3067	Transformer	240V
⑤	B2852	Power switch	
⑥	B2403	Fuse/250V-2A	100-110V
	B3011	Fuse/250V-2A	120V
	B2987	Fuse/250V-1A	220-240V

Item No.	Part No.	Part Name	Specifications	
⑦	B2419	Power cord, 3-wire cord & American plug	120V USA	
	B2421	Power cord, 3-wire cord but no plug		
	B2422	Power cord, 3-wire cord & BS plug	India	
	B2424	Power cord, 3-wire cord & European plug	220V KTL 230V CE	
	B2425	Power cord, 3-wire cord & BS plug	230V CE	
	B2436	Power cord, 3-wire cord & Chinese plug	China	
	B2426	Power cord, 3-wire cord & Australian plug		
	B3508	Power cord, 3-wire cord & American plug		
	B3550	Power cord, 3-wire cord & SI plug		
	B3616	Power cord, 3-wire cord & BR plug		
	⑧	B2972	Control card	
	⑨	B3253	Connecting cable	

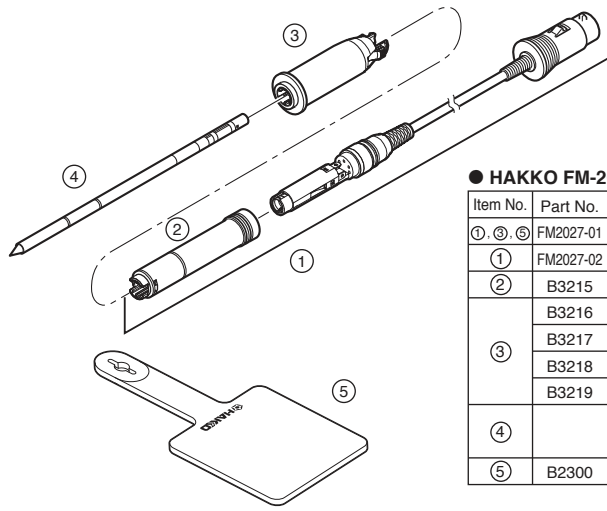

● HAKKO FM-2027

Item No.	Part No.	Part Name	Specifications
①, ③, ④	FM2027-01	Conversion kit	③ is yellow
①	FM2027-02	Connector assembly	
②	B3215	Connector cover	
③	B3216	Sleeve assembly	Yellow
	B3217	Sleeve assembly	Orange
	B3218	Sleeve assembly	Blue
	B3219	Sleeve assembly	Green
④		Tip	See back page: 'TIP STYLES'
⑤	B2300	Heat resistant pad	

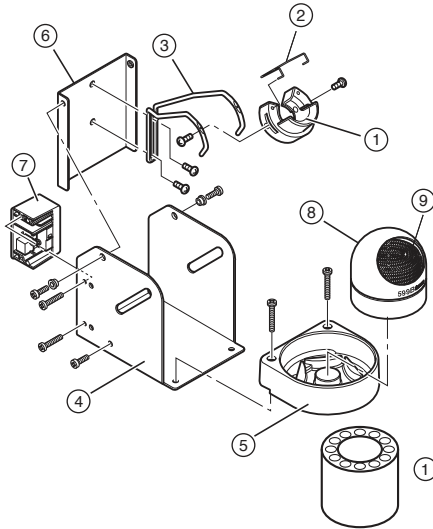

● Iron Holder

Item No.	Part No.	Part Name	Specifications
①-⑨	FH200-01	Iron holder	With 599B

● Iron Holder Parts

Item No.	Part No.	Part Name	Specifications
①	B3001	Iron receptacle	With screws
②	B2791	Tip fixing spring	
③	B3248	Holder for iron receptacle	
④	B3251	Iron holder base	With rubber feet
⑤	B3249	Cleaner base	With rubber feet
⑥	B3250	Stay	
⑦	B3252	Switch case assembly	
⑧	599B-02	Tip cleaner	
⑨	599-029	Cleaning wire	

● Tip tray

Item No.	Part No.	Part Name	Specifications
①	B2756	Tip tray	

2. PARAMETER SETTINGS

The HAKKO FX-951 comes from the factory with the following values preset.

Temperature scale	Fahrenheit
Power save	0 min.
Low temperature alarm setting	300°F
Resetting the supervisor or operator control setting	4 0
Setting temperature	750°F
Buzzer setting (C-E sound, S-E sound)	ON
Buzzer setting (Set temperature alert)	ON

● Entering the parameter

1 °C or °F temperature display

1. Turn power OFF.
2. Insert the control card into the card slot in the front of the unit.
3. Press and hold down the and buttons simultaneously, and then turn power ON.
4. Hold and buttons down until the display shows (Celsius) or (Fahrenheit).

When either the display shows either or the station is in parameter input mode.

- Pressing either the and button will cause the display to alternate between or .
- When the desired scale is displayed, select by pressing the button. The system will automatically sequence to power save mode.

The HAKKO FX-951 has the following six parameters:

- 1) °C or °F temperature display selection
- 2) Power save
- 3) Low temperature alarm setting
- 4) Resetting the supervisor/operator control setting
- 5) Buzzer setting (C-E sound, S-E sound)
- 6) Buzzer setting (Set temperature alert)

Once the station enters parameter mode, set the parameters in the order shown below. After all the parameters have been set, normal operation will be resumed.

2 Power save setting

Set the time from the placement of the soldering iron on the iron holder to the activation of the sleep function.

NOTE:

When not using the power save function, do not connect the iron holder and the soldering station with the connecting cable.

Power save example:

- 2 0 Sleep (immediately after the soldering iron is placed on the iron holder)
- 210 Sleep (10 minutes after the soldering iron is placed on the iron holder)
- 230 Auto-power shutoff (30 minutes after the soldering iron is placed on the iron holder)

NOTE:

The power save time can be set in steps of one minute (30 minutes max.)

- When the sleep function is activated, the temperature of the tip begins to drop.
- When the display shows $\boxed{S \cdot P}$, pressing any button the power will be turned on again.

NOTE:

The sleep function does not work in case the setting temperature is less than 300°C/570°F.

- When the auto-power shutoff function is activated and power to the heater is shut off, the buzzer sounds three times.
- When the display shows $\boxed{- - -}$, and to begin soldering, cycle the power switch OFF, then ON.

When the station enters the parameter input mode, the procedure is as follows.

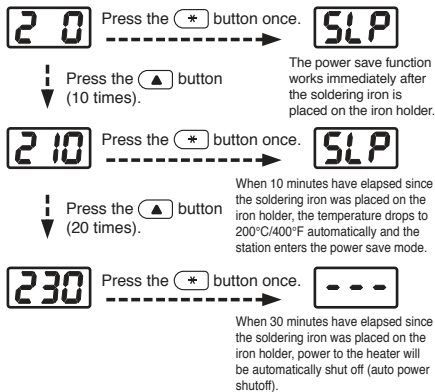

3 Resetting the low temperature alarm tolerance setting

The unique function alerts the operator when the sensed temperature drops below a set limit. Should this occur, an error message will be displayed, and the buzzer will sound continuously. When the temperature returns within the allowable range, the buzzer will stop.

Range of allowable low temperature alarm tolerance
for °C: 30 - 150°C
for °F: 50 - 300°F

1. When the station enters low-temperature alarm tolerance setting mode, the hundreds digit begins flashing. Enter and store the value in the same manner as described in "Changing the temperature setting."
2. If you enter a value exceeding the allowable range shown to the left, you will be brought back to entering a value in the hundreds digit. If this occurs, reenter a correct value.
3. Once the value is stored, the system will automatically sequence to resetting the supervisor/operator control setting mode.

Example:

When the setting temperature is 350°C and the low temperature alarm tolerance is 100°C, buzzer will sound when the tip temperature will drop over 250°C.

4. Resetting the supervisor/operator control setting

To change the supervisor/operator control settings, the procedure is as follows.

- The display will show $\boxed{4 \cdot 0}$ or $\boxed{4 \cdot 1}$ when this mode is entered.

$\boxed{4 \cdot 0}$: No offset value can be entered without inserting the card.

$\boxed{4 \cdot 1}$: An offset value can be entered without inserting the card.

Pressing the $\boxed{\uparrow}$ or $\boxed{\downarrow}$ button will change $\boxed{4 \cdot 0}$ and $\boxed{4 \cdot 1}$.

When the desired setting is displayed, select by pressing $\boxed{*}$ button.

5. Buzzer setting (C-E sound, S-E sound)

- In the buzzer sound setting mode, which sets whether to sound the buzzer when a sensor error or soldering iron error occurs, $\boxed{5 \cdot 0}$ or $\boxed{5 \cdot 1}$ is displayed.

$\boxed{5 \cdot 0}$: The buzzer does not sound.

$\boxed{5 \cdot 1}$: The buzzer sound

Select $\boxed{\uparrow}$ or $\boxed{\downarrow}$ and press the $\boxed{*}$ button.

6. Buzzer setting (Set temperature alert)

- In the buzzer sound setting mode, which sets whether to sound the buzzer when a sensor error or soldering iron error occurs, $\boxed{6 \cdot 0}$ or $\boxed{6 \cdot 1}$ is displayed.

$\boxed{6 \cdot 0}$: The buzzer does not sound.

$\boxed{6 \cdot 1}$: The buzzer sound

Select $\boxed{\uparrow}$ or $\boxed{\downarrow}$ and press the $\boxed{*}$ button.

The system will exit the parameter setting mode and begin heater control.

It is now ready for normal operation.

3. CHECKING PROCEDURE

⚠ WARNING

Unless otherwise directed, carry out these procedures with the power switch OFF and the power UNPLUGGED.

● Check for a broken heater or sensor

1. Check for a broken heater or sensor

Measure the resistance across this position.

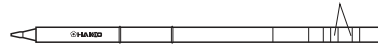

Verify the electrical integrity of the heater and sensor. Measure the resistance of the heater and sensor while at room temperature (15 to 25°C.; 59 to 77°F.). It should be $8\Omega \pm 10\%$. If the resistance exceeds these limits, replace the tip.

● Check the grounding line

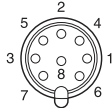

1. Unplug the connection cord from the station.
2. Measure the resistance value between Pin 2 and the tip.
3. If the value exceeds 2Ω (at room temperature), perform the tip maintenance described on section 2, maintenance for the tip. If the value still does not decrease, check the connection cord for breakage.

● Checking the connection cord for breakage

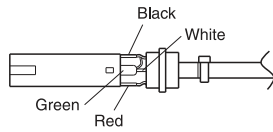

1. Remove the soldering tip and the sleeve assembly.
2. Turn the front piece of the HAKKO FM-2027 counterclockwise and remove the cover.
3. Measure the resistance values between the connector and the lead wires at the socket as follows:

Pin 1 – Red Pin 2 – Green
Pin 3 – Black Pin 5 – White

If any value exceeds 0Ω or is ∞ , replace the HAKKO FM-2027

● Replacing the fuse

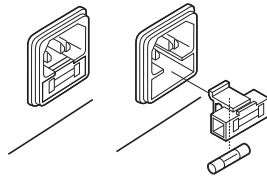

1. Unplug the power cord from the power receptacle.
2. Remove the fuse holder.
3. Replace the fuse.
4. Put the fuse holder back in place.

4. ERROR MESSAGES

● Sensor Error



When there is the possibility that a failure has occurred in the sensor or heater (including the sensor circuit), **S-E** is displayed and the power is shut down.

⚠ CAUTION

The sensor error also occurs if the tip is not inserted properly.

● Low-temperature alarm tolerance error



If the sensor temperature falls below the difference between the current temperature setting and the low-temperature alarm tolerance, **H-E** is displayed and the warning buzzer sounds. When the tip temperature rises to a value within the set tolerance, the buzzer will stop sounding.

EXAMPLE:

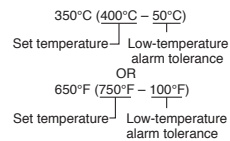

EXAMPLE:

Assume that the temperature setting is 400°C/750°F and the tolerance 50°C/100°F. If the temperature continues to decrease and finally falls below the value indicated below while the heating element is on, the displayed value starts blinking to indicate that the tip temperature has dropped.

● Heater terminal short-circuit error



HSE will flash, and the buzzer will sound continuously, when the tip is inserted wrong way round, an incompatible tip is inserted, or a foreign object has found its way into the connector.

● Soldering iron error



I-E will be displayed if the connector cord is not attached to the station OR the wrong soldering iron is connected.

5. TIP STYLES

SHAPE K	T15-K SHAPE-K	T15-KF SHAPE-KF	T15-KL SHAPE-KL	T15-KU SHAPE-KU	
	T15-R20 SHAPE-2.0R	T15-R23 SHAPE-2.3R	T15-R27 SHAPE-2.7R	T15-R34 SHAPE-3.4R	T15-R48 SHAPE-4.8R
	T15-SB02 SHAPE-0.2SB	T15-SB03 SHAPE-0.3SB	T15-SB05 SHAPE-0.5SB	T15-SB08 SHAPE-0.8SB	T15-SBC04 SHAPE-0.4SBC
	T15-SBS04 SHAPE-0.4SBS	T15-SBS07 SHAPE-0.7SBS			
TUNNEL	T15-1001** TUNNEL 5.1 x 4.6	T15-1002** TUNNEL 5.1 x 10.4	T15-1003** TUNNEL 9.5 x 18.3	T15-1004** TUNNEL 9.5 x 15.8	T15-1005** TUNNEL 9.5 x 13.2
	T15-1006** TUNNEL 6.9 x 11.4	T15-1007** TUNNEL 7.9 x 18.8	T15-1008** TUNNEL 19.5 x 10.2	T15-1009** TUNNEL 13.4 x 20.5	T15-1010** TUNNEL 19.5 x 12
	T15-1201** QUAD 13.6 x 8.5	T15-1202** QUAD 10.3 x 10.3	T15-1203** QUAD 12.8 x 12.8	T15-1204** QUAD 17.9 x 17.9	T15-1205** QUAD 23.4 x 17.3
	T15-1206** QUAD 22.5 x 16.5	T15-1207** QUAD 15.5 x 15.5	T15-1208** QUAD 15.8 x 15.8	T15-1209** QUAD 8.4 x 8.4	T15-1210** QUAD 15.4 x 12.8
	T15-1401** SPATULA 10.4	T15-1402** SPATULA 15.7	T15-1403** SPATULA 21.2	T15-1406** SPATULA 40	
	T15-1603** SHAPE-1.8MM LONG REACH CHISEL	T15-1605** SHAPE-LONG REACH BENT CHISEL	T15-BCM2 SHAPE-2BC Bevel with indent**	T15-BCM3 SHAPE-3BC Bevel with indent**	

* Tinned on the soldering surface only.

** The iron tips marked with double asterisks (**) have a temperature accuracy of $\pm 25^{\circ}\text{C}$ ($\pm 45^{\circ}\text{F}$), when used with the default offset. Others have a temperature accuracy of $\pm 15^{\circ}\text{C}$ ($\pm 27^{\circ}\text{F}$), when used with the default offset.