

RF Power Field Effect Transistors

N-Channel Enhancement-Mode Lateral MOSFETs

Designed for W-CDMA base station applications with frequencies from 2110 to 2170 MHz. Suitable for TDMA, CDMA and multicarrier amplifier applications. To be used in Class AB for PCN-PCS/cellular radio and WLL applications.

- Typical 2-Carrier W-CDMA Performance: $V_{DD} = 28$ Volts, $I_{DQ} = 1000$ mA, $P_{out} = 19$ Watts Avg., Full Frequency Band, Channel Bandwidth = 3.84 MHz, Peak/Avg. = 8.5 dB @ 0.01% Probability on CCDF.
Power Gain — 13.6 dB
Drain Efficiency — 23%
IM3 @ 10 MHz Offset — -37.5 dBc in 3.84 MHz Channel Bandwidth
ACPR @ 5 MHz Offset — -41 dBc in 3.84 MHz Channel Bandwidth
- Capable of Handling 5:1 VSWR, @ 28 Vdc, 2140 MHz, 90 Watts CW Output Power

Features

- Internally Matched for Ease of Use
- High Gain, High Efficiency and High Linearity
- Integrated ESD Protection
- Designed for Maximum Gain and Insertion Phase Flatness
- Excellent Thermal Stability
- Characterized with Series Equivalent Large-Signal Impedance Parameters
- Available with Low Gold Plating Thickness on Leads. L Suffix Indicates 40 μ " Nominal.
- RoHS Compliant
- In Tape and Reel. R3 Suffix = 250 Units per 56 mm, 13 inch Reel.

MRF21085LR3
MRF21085LSR3

2110-2170 MHz, 90 W, 28 V
LATERAL N-CHANNEL
RF POWER MOSFETs

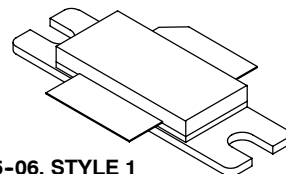

CASE 465-06, STYLE 1
NI-780
MRF21085LR3

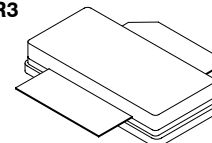

CASE 465A-06, STYLE 1
NI-780S
MRF21085LSR3

Table 1. Maximum Ratings

Rating	Symbol	Value	Unit
Drain-Source Voltage	V_{DSS}	-0.5, +65	Vdc
Gate-Source Voltage	V_{GS}	-0.5, +15	Vdc
Total Device Dissipation @ $T_C = 25^\circ\text{C}$ Derate above 25 $^\circ\text{C}$	P_D	224 1.28	W W/ $^\circ\text{C}$
Storage Temperature Range	T_{stg}	-65 to +150	$^\circ\text{C}$
Case Operating Temperature	T_C	150	$^\circ\text{C}$
Operating Junction Temperature	T_J	200	$^\circ\text{C}$

Table 2. Thermal Characteristics

Characteristic	Symbol	Value	Unit
Thermal Resistance, Junction to Case	$R_{\theta JC}$	0.78	$^\circ\text{C}/\text{W}$

Table 3. ESD Protection Characteristics

Test Conditions	Class
Human Body Model	1 (Minimum)
Machine Model	M3 (Minimum)

Table 4. Electrical Characteristics ($T_C = 25^\circ\text{C}$ unless otherwise noted)

Characteristic	Symbol	Min	Typ	Max	Unit
Off Characteristics					
Drain-Source Breakdown Voltage ($V_{GS} = 0\text{ Vdc}$, $I_D = 100\ \mu\text{Adc}$)	$V_{(BR)DSS}$	65	—	—	Vdc
Zero Gate Voltage Drain Current ($V_{DS} = 28\text{ Vdc}$, $V_{GS} = 0\text{ Vdc}$)	I_{DSS}	—	—	10	μAdc
Gate-Source Leakage Current ($V_{GS} = 5\text{ Vdc}$, $V_{DS} = 0\text{ Vdc}$)	I_{GSS}	—	—	1	μAdc
On Characteristics (DC)					
Gate Threshold Voltage ($V_{DS} = 10\text{ Vdc}$, $I_D = 200\ \mu\text{Adc}$)	$V_{GS(th)}$	2	—	4	Vdc
Gate Quiescent Voltage ($V_{DS} = 28\text{ Vdc}$, $I_D = 1000\text{ mAdc}$)	$V_{GS(Q)}$	3	3.9	5	Vdc
Drain-Source On-Voltage ($V_{GS} = 10\text{ Vdc}$, $I_D = 2\text{ Adc}$)	$V_{DS(on)}$	—	0.18	0.21	Vdc
Dynamic Characteristics (1)					
Reverse Transfer Capacitance ($V_{DS} = 28\text{ Vdc}$, $V_{GS} = 0$, $f = 1.0\text{ MHz}$)	C_{rss}	—	3.6	—	pF
Functional Tests (In Freescale Test Fixture, 50 ohm system) 2-carrier W-CDMA, 3.84 MHz Channel Bandwidth Carriers, ACPR and IM3 measured in 3.84 MHz Bandwidth. Peak/Avg. = 8.3 dB @ 0.01% Probability on CCDF.					
Common-Source Amplifier Power Gain ($V_{DD} = 28\text{ Vdc}$, $P_{out} = 19\text{ W Avg.}$, $I_{DQ} = 1000\text{ mA}$, $f_1 = 2112.5\text{ MHz}$, $f_2 = 2122.5\text{ MHz}$ and $f_1 = 2157.5\text{ MHz}$, $f_2 = 2167.5\text{ MHz}$)	G_{ps}	12	13.6	—	dB
Drain Efficiency ($V_{DD} = 28\text{ Vdc}$, $P_{out} = 19\text{ W Avg.}$, $I_{DQ} = 1000\text{ mA}$, $f_1 = 2112.5\text{ MHz}$, $f_2 = 2122.5\text{ MHz}$ and $f_1 = 2157.5\text{ MHz}$, $f_2 = 2167.5\text{ MHz}$)	η	20	23	—	%
Third Order Intermodulation Distortion ($V_{DD} = 28\text{ Vdc}$, $P_{out} = 19\text{ W Avg.}$, $I_{DQ} = 1000\text{ mA}$, $f_1 = 2112.5\text{ MHz}$, $f_2 = 2122.5\text{ MHz}$ and $f_1 = 2157.5\text{ MHz}$, $f_2 = 2167.5\text{ MHz}$; IM3 measured over 3.84 MHz BW at $f_1 - 10\text{ MHz}$ and $f_2 + 10\text{ MHz}$ referenced to carrier channel power.)	IM3	—	-37.5	-35	dBc
Adjacent Channel Power Ratio ($V_{DD} = 28\text{ Vdc}$, $P_{out} = 19\text{ W Avg.}$, $I_{DQ} = 1000\text{ mA}$, $f_1 = 2112.5\text{ MHz}$, $f_2 = 2122.5\text{ MHz}$ and $f_1 = 2157.5\text{ MHz}$, $f_2 = 2167.5\text{ MHz}$; ACPR measured over 3.84 MHz at $f_1 - 5\text{ MHz}$ and $f_2 + 5\text{ MHz}$.)	ACPR	—	-41	-38	dBc
Input Return Loss ($V_{DD} = 28\text{ Vdc}$, $P_{out} = 19\text{ W Avg.}$, $I_{DQ} = 1000\text{ mA}$, $f_1 = 2112.5\text{ MHz}$, $f_2 = 2122.5\text{ MHz}$ and $f_1 = 2157.5\text{ MHz}$, $f_2 = 2167.5\text{ MHz}$)	IRL	—	-12	-9	dB

1. Part is internally matched both on input and output.

(continued)

Table 4. Electrical Characteristics ($T_C = 25^\circ\text{C}$ unless otherwise noted) **(continued)**

Characteristic	Symbol	Min	Typ	Max	Unit
Functional Tests (In Freescale Test Fixture, 50 ohm system) (continued)					
Two-Tone Common-Source Amplifier Power Gain ($V_{DD} = 28\text{ Vdc}$, $P_{out} = 90\text{ W PEP}$, $I_{DQ} = 1000\text{ mA}$, $f_1 = 2110\text{ MHz}$, $f_2 = 2120\text{ MHz}$ and $f_1 = 2160\text{ MHz}$, $f_2 = 2170\text{ MHz}$)	G_{ps}	—	13.6	—	dB
Two-Tone Drain Efficiency ($V_{DD} = 28\text{ Vdc}$, $P_{out} = 90\text{ W PEP}$, $I_{DQ} = 1000\text{ mA}$, $f_1 = 2110\text{ MHz}$, $f_2 = 2120\text{ MHz}$ and $f_1 = 2160\text{ MHz}$, $f_2 = 2170\text{ MHz}$)	η	—	36	—	%
Two-Tone Intermodulation Distortion ($V_{DD} = 28\text{ Vdc}$, $P_{out} = 90\text{ W PEP}$, $I_{DQ} = 1000\text{ mA}$, $f_1 = 2110\text{ MHz}$, $f_2 = 2120\text{ MHz}$ and $f_1 = 2160\text{ MHz}$, $f_2 = 2170\text{ MHz}$)	IMD	—	-31	—	dBc
Input Return Loss ($V_{DD} = 28\text{ Vdc}$, $P_{out} = 90\text{ W PEP}$, $I_{DQ} = 1000\text{ mA}$, $f_1 = 2110\text{ MHz}$, $f_2 = 2120\text{ MHz}$ and $f_1 = 2160\text{ MHz}$, $f_2 = 2170\text{ MHz}$)	IRL	—	-12	—	dB
P_{out} , 1 dB Compression Point ($V_{DD} = 28\text{ Vdc}$, $I_{DQ} = 1000\text{ mA}$, $f = 2170\text{ MHz}$)	P1dB	—	100	—	W

ARCHIVE INFORMATION

ARCHIVE INFORMATION

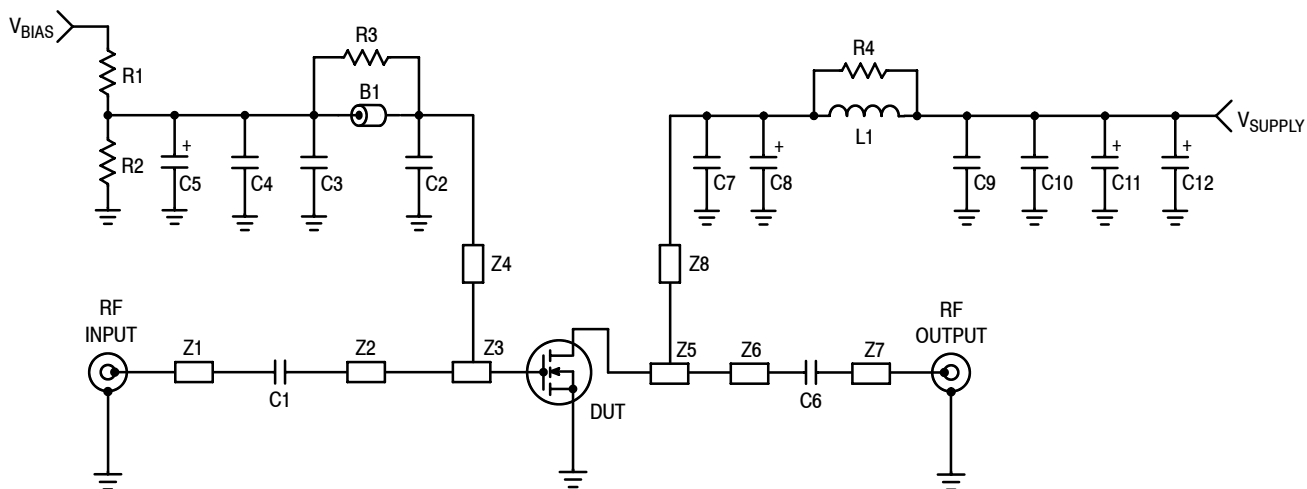

Z1	0.750" x 0.084" Microstrip
Z2	1.015" x 0.084" Microstrip
Z3	0.480" x 0.800" Microstrip
Z4	0.750" x 0.050" Microstrip
Z5	0.610" x 0.800" Microstrip
Z6	0.885" x 0.084" Microstrip
Z7	0.720" x 0.084" Microstrip
Z8	0.800" x 0.070" Microstrip

Board 0.030" Glass Teflon®,
Keene GX-0300-55-22, $\epsilon_r = 2.55$
PCB Etched Circuit Boards
MRF21085 Rev. 3, CMR

Figure 1. MRF21085L Test Circuit Schematic

Table 5. MRF21085 Test Circuit Component Designations and Values

Designators	Description
B1	Short Ferrite Bead, Fair Rite, #2743019447
C1, C6	43 pF Chip Capacitors, ATC #100B430JCA500X
C2	10 pF Chip Capacitor, ATC #100B100JCA500X
C3, C9	1000 pF Chip Capacitors, ATC #100B102JCA500X
C4, C10	0.1 μ F Chip Capacitors, Kemet #CDR33BX104AKWS
C5	1.0 μ F Tantalum Chip Capacitor, Kemet #T491C105M050
C7	2.7 pF Chip Capacitor, ATC #100B2R7JCA500X
C8	10 μ F Tantalum Chip Capacitor, Kemet #T495X106K035AS4394
C11, C12	22 μ F Tantalum Chip Capacitors, Kemet #T491X226K035AS4394
L1	1 Turn, #20 AWG, 0.100" ID
N1, N2	Type N Flange Mounts, Omni Spectra #3052-1648-10
R1	1.0 k Ω , 1/8 W Chip Resistor
R2	180 k Ω , 1/8 W Chip Resistor
R3, R4	10 Ω , 1/8 W Chip Resistors

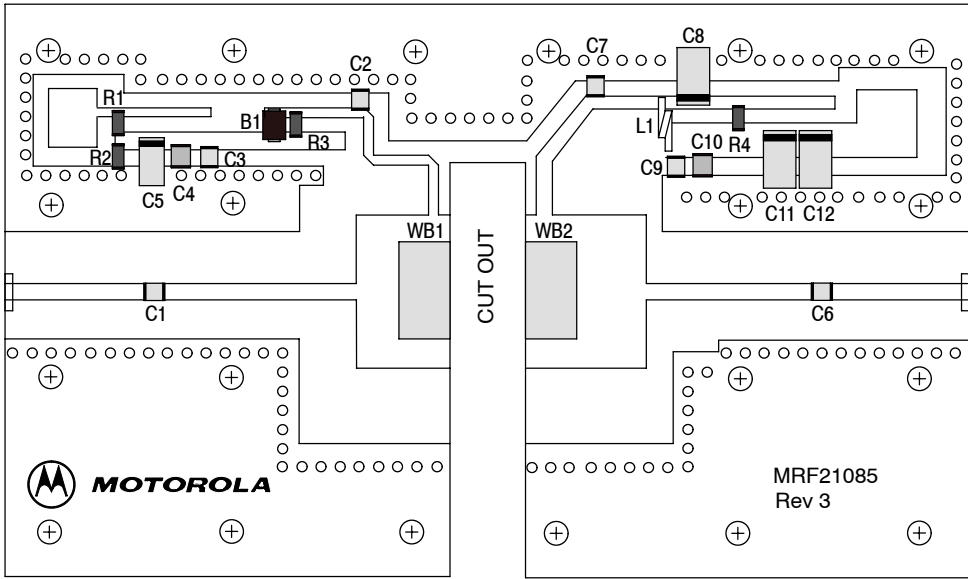

Freescale has begun the transition of marking Printed Circuit Boards (PCBs) with the Freescale Semiconductor signature/logo. PCBs may have either Motorola or Freescale markings during the transition period. These changes will have no impact on form, fit or function of the current product.

Figure 2. MRF21085L Test Circuit Component Layout

TYPICAL CHARACTERISTICS

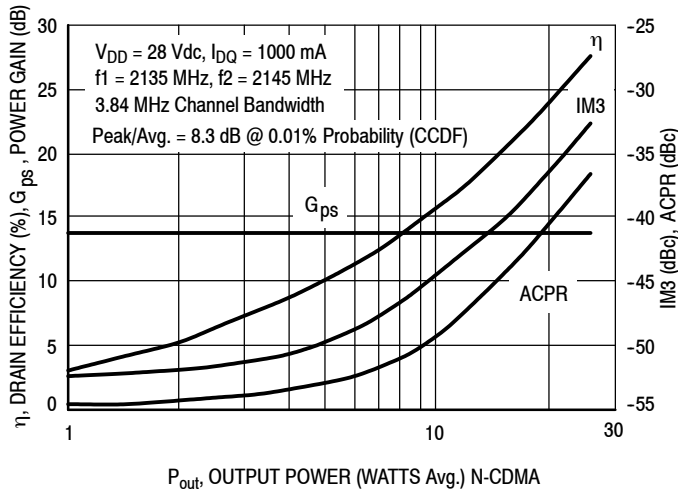

Figure 3. 2-Carrier W-CDMA ACPR, IM3, Power Gain and Drain Efficiency versus Output Power

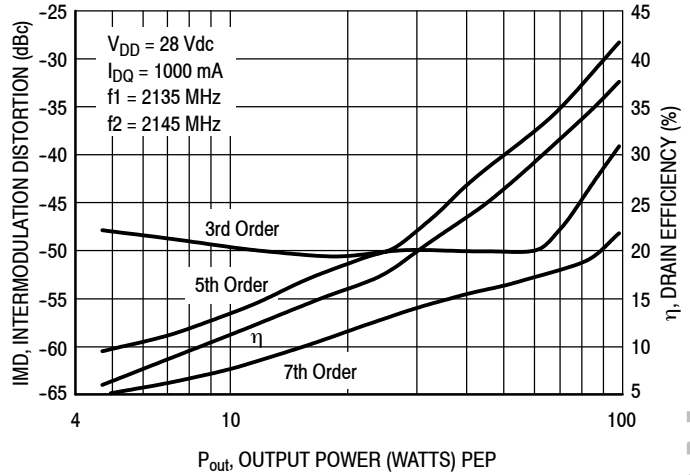

Figure 4. Intermodulation Distortion Products versus Output Power

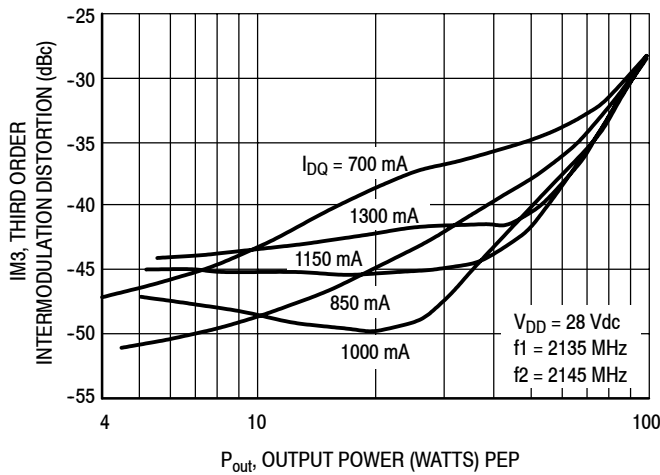

Figure 5. Third Order Intermodulation Distortion versus Output Power

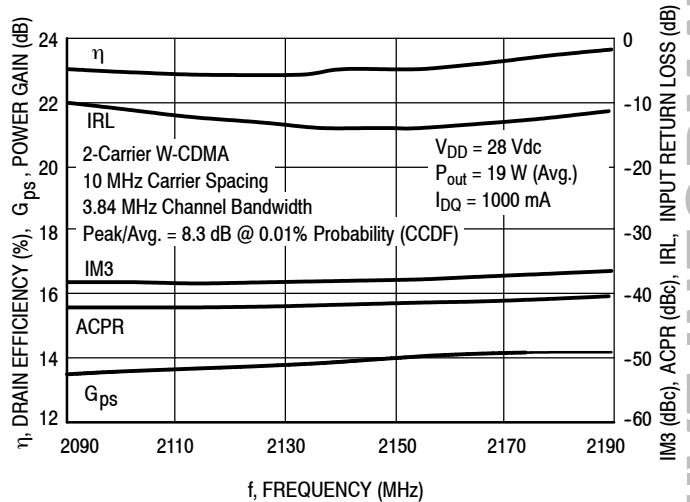

Figure 6. 2-Carrier W-CDMA Broadband Performance

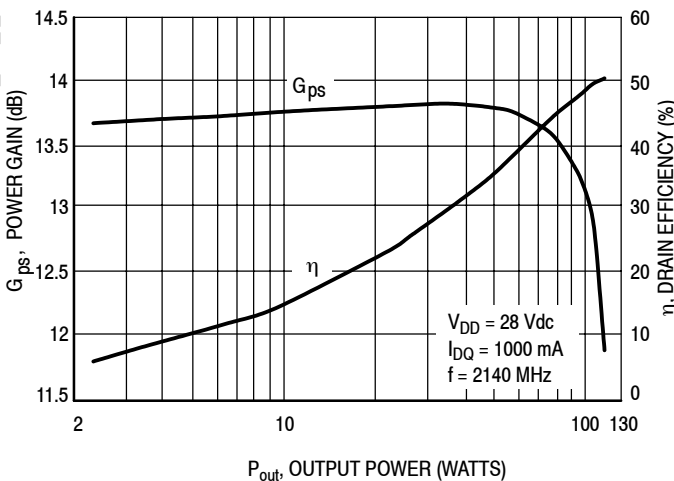

Figure 7. CW Performance

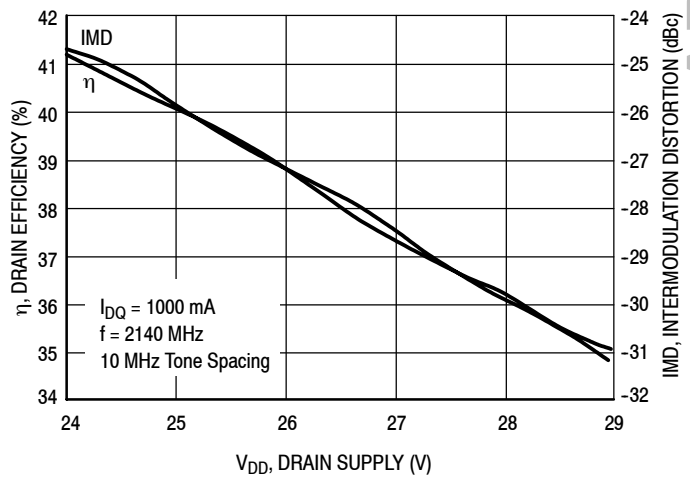

Figure 8. Two-Tone Intermodulation Distortion and Drain Efficiency versus Drain Supply

TYPICAL CHARACTERISTICS

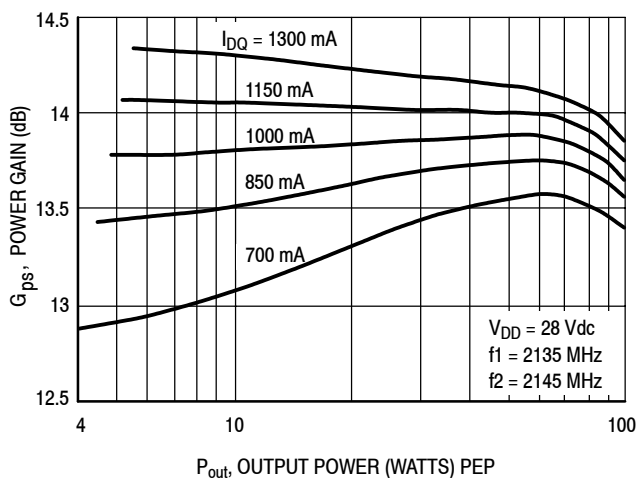

Figure 9. Two-Tone Power Gain versus Output Power

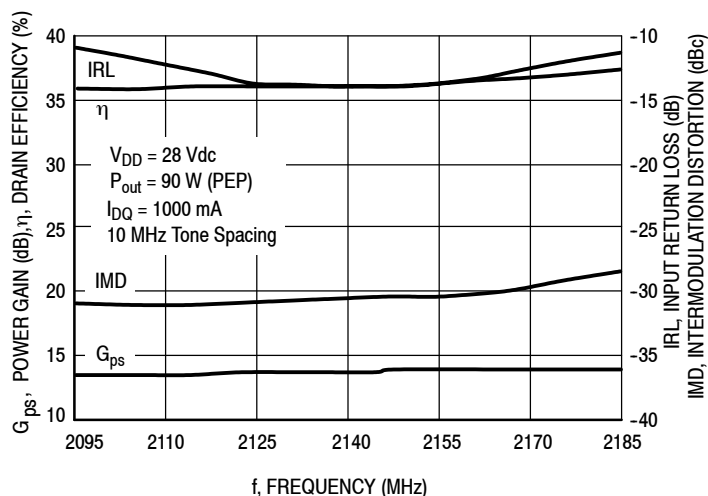

Figure 10. Two-Tone Broadband Performance

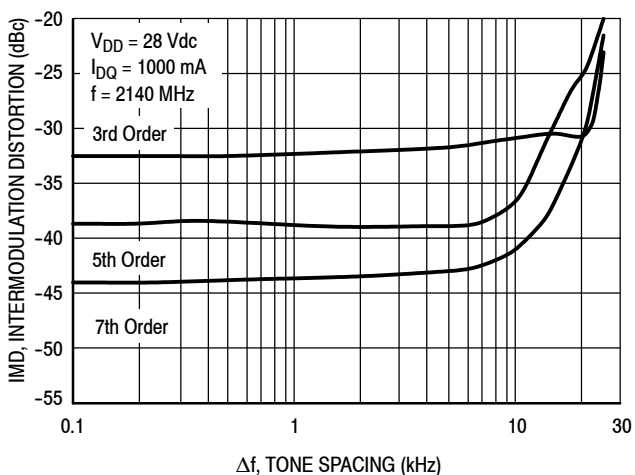

Figure 11. Intermodulation Distortion Products versus Two-Tone Spacing

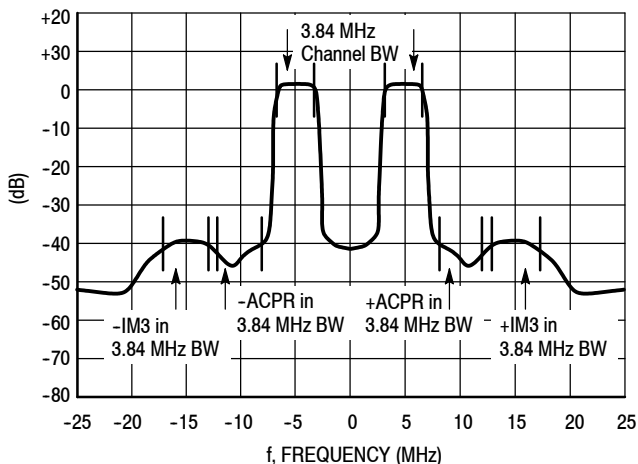
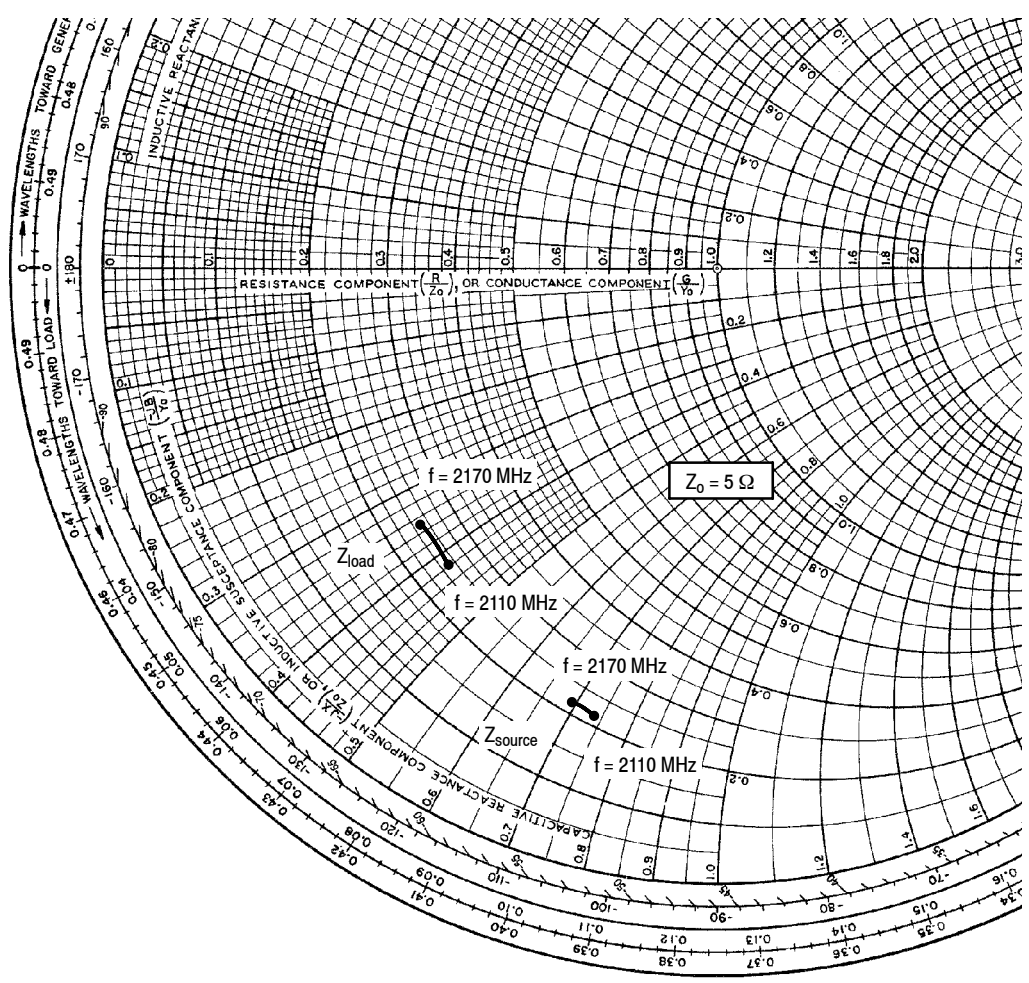

Figure 12. 2-Carrier W-CDMA Spectrum

ARCHIVE INFORMATION

ARCHIVE INFORMATION



$V_{DD} = 28 \text{ V}$, $I_{DQ} = 1000 \text{ mA}$, $P_{out} = 19 \text{ W Avg.}$

f MHz	Z _{source} Ω	Z _{load} Ω
2110	1.10 - j3.71	1.23 - j2.10
2140	1.11 - j3.57	1.26 - j1.92
2170	1.12 - j3.40	1.25 - j1.76

Z_{source} = Test circuit impedance as measured from gate to ground.
 Z_{load} = Test circuit impedance as measured from drain to ground.

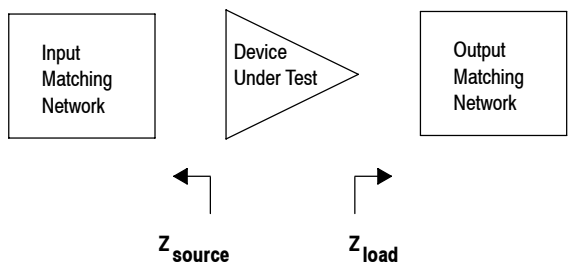

Figure 13. Series Equivalent Source and Load Impedance

ARCHIVE INFORMATION

ARCHIVE INFORMATION

ARCHIVE INFORMATION

ARCHIVE INFORMATION

PACKAGE DIMENSIONS

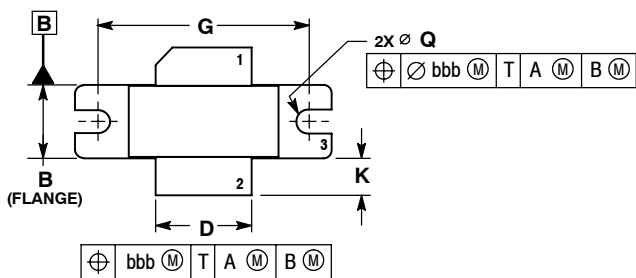

- NOTES:
1. DIMENSIONING AND TOLERANCING PER ANSI Y14.5M-1994.
 2. CONTROLLING DIMENSION: INCH.
 3. DELETED
 4. DIMENSION H IS MEASURED 0.030 (0.762) AWAY FROM PACKAGE BODY.

DIM	INCHES		MILLIMETERS	
	MIN	MAX	MIN	MAX
A	1.335	1.345	33.91	34.16
B	0.380	0.390	9.65	9.91
C	0.125	0.170	3.18	4.32
D	0.495	0.505	12.57	12.83
E	0.035	0.045	0.89	1.14
F	0.003	0.006	0.08	0.15
G	1.100	BSC	27.94	BSC
H	0.057	0.067	1.45	1.70
K	0.170	0.210	4.32	5.33
M	0.774	0.786	19.66	19.96
N	0.772	0.788	19.60	20.00
Q	∅.118	∅.138	∅3.00	∅3.51
R	0.365	0.375	9.27	9.53
S	0.365	0.375	9.27	9.52
aaa	0.005	REF	0.127	REF
bbb	0.010	REF	0.254	REF
ccc	0.015	REF	0.381	REF

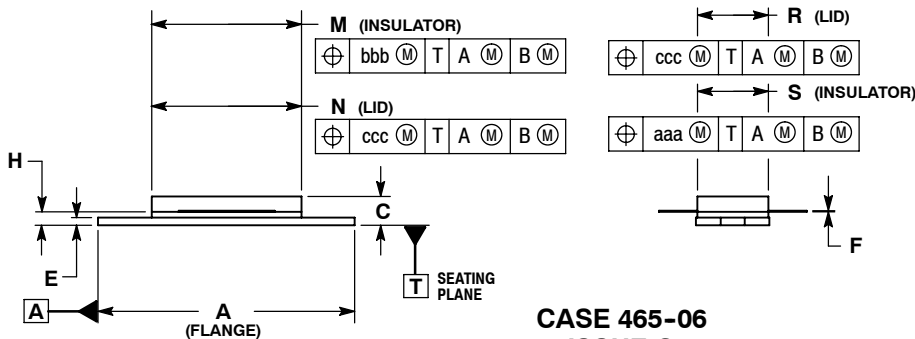

**CASE 465-06
ISSUE G
NI-780
MRF21085LR3**

- STYLE 1:
PIN 1. DRAIN
2. GATE
3. SOURCE

ARCHIVE INFORMATION

ARCHIVE INFORMATION

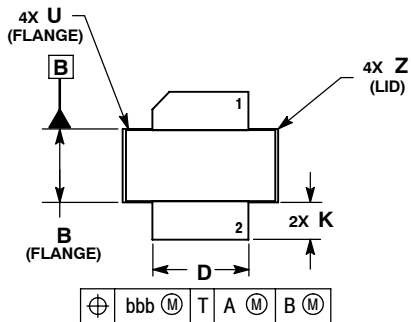

- NOTES:
1. DIMENSIONING AND TOLERANCING PER ANSI Y14.5M-1994.
 2. CONTROLLING DIMENSION: INCH.
 3. DELETED
 4. DIMENSION H IS MEASURED 0.030 (0.762) AWAY FROM PACKAGE BODY.

DIM	INCHES		MILLIMETERS	
	MIN	MAX	MIN	MAX
A	0.805	0.815	20.45	20.70
B	0.380	0.390	9.65	9.91
C	0.125	0.170	3.18	4.32
D	0.495	0.505	12.57	12.83
E	0.035	0.045	0.89	1.14
F	0.003	0.006	0.08	0.15
H	0.057	0.067	1.45	1.70
K	0.170	0.210	4.32	5.33
M	0.774	0.786	19.61	20.02
N	0.772	0.788	19.61	20.02
R	0.365	0.375	9.27	9.53
S	0.365	0.375	9.27	9.52
U	---	0.040	---	1.02
Z	---	0.030	---	0.76
aaa	0.005	REF	0.127	REF
bbb	0.010	REF	0.254	REF
ccc	0.015	REF	0.381	REF

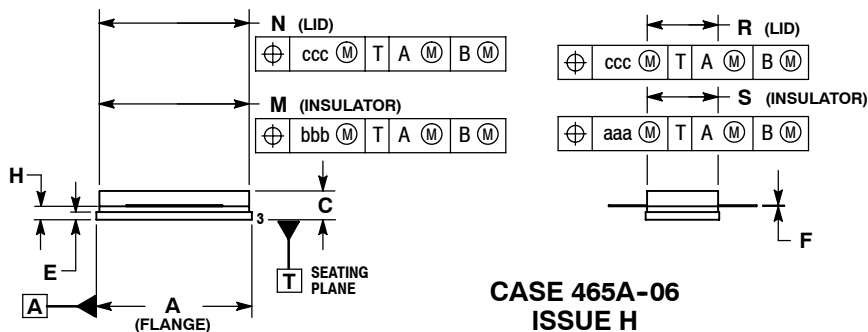

**CASE 465A-06
ISSUE H
NI-780S
MRF21085LSR3**

- STYLE 1:
PIN 1. DRAIN
2. GATE
5. SOURCE

REVISION HISTORY

The following table summarizes revisions to this document.

Revision	Date	Description
9	Dec. 2010	<ul style="list-style-type: none"> • MRF21085 Rev. 9 data sheet archived. Data sheet split due to change in part life cycle. See MRF21085-1 Rev. 10 for MRF21085LR3 and MRF21085-2 Rev. 11 for MRF21085LSR3.

ARCHIVE INFORMATION

ARCHIVE INFORMATION

How to Reach Us:

Home Page:
www.freescale.com

E-mail:
support@freescale.com

USA/Europe or Locations Not Listed:
Freescale Semiconductor
Technical Information Center, CH370
1300 N. Alma School Road
Chandler, Arizona 85224
+1-800-521-6274 or +1-480-768-2130
support@freescale.com

Europe, Middle East, and Africa:
Freescale Halbleiter Deutschland GmbH
Technical Information Center
Schatzbogen 7
81829 Muenchen, Germany
+44 1296 380 456 (English)
+46 8 52200080 (English)
+49 89 92103 559 (German)
+33 1 69 35 48 48 (French)
support@freescale.com

Japan:
Freescale Semiconductor Japan Ltd.
Headquarters
ARCO Tower 15F
1-8-1, Shimo-Meguro, Meguro-ku,
Tokyo 153-0064
Japan
0120 191014 or +81 3 5437 9125
support.japan@freescale.com

Asia/Pacific:
Freescale Semiconductor Hong Kong Ltd.
Technical Information Center
2 Dai King Street
Tai Po Industrial Estate
Tai Po, N.T., Hong Kong
+800 2666 8080
support.asia@freescale.com

For Literature Requests Only:
Freescale Semiconductor Literature Distribution Center
P.O. Box 5405
Denver, Colorado 80217
1-800-441-2447 or 303-675-2140
Fax: 303-675-2150
LDCForFreescaleSemiconductor@hibbertgroup.com

Information in this document is provided solely to enable system and software implementers to use Freescale Semiconductor products. There are no express or implied copyright licenses granted hereunder to design or fabricate any integrated circuits or integrated circuits based on the information in this document.

Freescale Semiconductor reserves the right to make changes without further notice to any products herein. Freescale Semiconductor makes no warranty, representation or guarantee regarding the suitability of its products for any particular purpose, nor does Freescale Semiconductor assume any liability arising out of the application or use of any product or circuit, and specifically disclaims any and all liability, including without limitation consequential or incidental damages. "Typical" parameters that may be provided in Freescale Semiconductor data sheets and/or specifications can and do vary in different applications and actual performance may vary over time. All operating parameters, including "Typicals", must be validated for each customer application by customer's technical experts. Freescale Semiconductor does not convey any license under its patent rights nor the rights of others. Freescale Semiconductor products are not designed, intended, or authorized for use as components in systems intended for surgical implant into the body, or other applications intended to support or sustain life, or for any other application in which the failure of the Freescale Semiconductor product could create a situation where personal injury or death may occur. Should Buyer purchase or use Freescale Semiconductor products for any such unintended or unauthorized application, Buyer shall indemnify and hold Freescale Semiconductor and its officers, employees, subsidiaries, affiliates, and distributors harmless against all claims, costs, damages, and expenses, and reasonable attorney fees arising out of, directly or indirectly, any claim of personal injury or death associated with such unintended or unauthorized use, even if such claim alleges that Freescale Semiconductor was negligent regarding the design or manufacture of the part.

Freescale™ and the Freescale logo are trademarks of Freescale Semiconductor, Inc. All other product or service names are the property of their respective owners.
© Freescale Semiconductor, Inc. 2006, 2010. All rights reserved.