



Main

Range of Product	Harmony XAC
Product or Component Type	Pendant control station
Device short name	XACB

Complementary

Control station type	Double insulated
Enclosure Material	Glass reinforced polyester
Electrical circuit type	Power circuit
Enclosure type	Complete ready for use
Control station application	Control of single speed hoist motor
Control station composition	2 push-buttons
Control button type	First push-button 2-pole raise, slow Second push-button 2-pole lower, slow
Product compatibility	XESD1191 for reversing operation
Mechanical interlocking	With mechanical interlocking
Control station colour	Yellow
Connections - terminals	Screw clamp terminals, 1 x 2.5 mm ² with or without cable end Screw clamp terminals, 2 x 1.5 mm ² with or without cable end
Standards	CSA C22.2 No 14 EN/IEC 60947-5-1 EN/IEC 60204-32
Product Certifications	CSA type 4
Protective treatment	TH
Ambient air temperature for operation	-13...158 °F (-25...70 °C)
Ambient Air Temperature for Storage	-40...158 °F (-40...70 °C)
Vibration resistance	15 gn 10...500 Hz)IEC 60068-2-6
Shock resistance	100 gn IEC 60068-2-27
Overvoltage category	Class II IEC 61140
IP degree of protection	IP65 conforming to IEC 60529
Mechanical durability	1000000 cycles
Cable entry	Rubber sleeve with stepped entry 0.39...0.87 in (10...22 mm)
[Ithe] conventional enclosed thermal current	12 A
[Ui] rated insulation voltage	500 V 3)IEC 60947-1 600 VCSA
[Uimp] rated impulse withstand voltage	6 kV IEC 60947-1
Contact operation	Snap action
Operating force	17 N push-button
Short-circuit protection	10 A fuse protection cartridge aM
Rated power in hp	2 Hp 240 V, CSA 3 Hp 600 V, CSA 5 hp 400 V, CSA

Rated operational power in W	2200 W AC-3 240 V IEC 60947-3 appendix A 2200 W AC-3 400 V IEC 60947-3 appendix A 2200 W AC-4 240 V IEC 60947-3 appendix A 2200 W AC-4 400 V IEC 60947-3 appendix A
Electrical durability	300000 Cycles AC-3, 2200 W 240 V 10 cyc/mn 0.4 IEC 60947-3 appendix A 300000 Cycles AC-3, 2200 W 400 V 10 cyc/mn 0.4 IEC 60947-3 appendix A 300000 Cycles AC-4, 2200 W 240 V 10 cyc/mn 0.4 IEC 60947-3 appendix A 300000 Cycles AC-4, 2200 W 400 V 10 cyc/mn 0.4 IEC 60947-3 appendix A 500000 Cycles AC-3, 1500 W 240 V 10 cyc/mn 0.4 IEC 60947-3 appendix A 500000 Cycles AC-4, 1500 W 240 V 10 cyc/mn 0.4 IEC 60947-3 appendix A 800000 Cycles AC-3, 1500 W 400 V 10 cyc/mn 0.4 IEC 60947-3 appendix A 800000 cycles AC-4, 1500 W 400 V 10 cyc/mn 0.4 IEC 60947-3 appendix A
Terminals description ISO n°1	(43-44)NO (23-24)NO (13-14)NO (33-34)NO
Terminal identifier	(13-14)NO (11-12)NC
Net Weight	0.78 lb(US) (0.355 kg)





Ordering and shipping details

Category	22473 - PUSHBUTTON, PENDANTS
Discount Schedule	CS2
GTIN	3389110636154
Nbr. of units in pkg.	1
Package weight(Lbs)	26.95 oz (764 g)
Returnability	No
Country of origin	CZ

Packing Units

Unit Type of Package 1	PCE
Package 1 Height	4.13 in (10.5 cm)
Package 1 width	4.53 in (11.5 cm)
Package 1 Length	10.43 in (26.5 cm)
Unit Type of Package 2	S03
Number of Units in Package 2	6
Package 2 Weight	11.35 lb(US) (5.15 kg)
Package 2 Height	11.81 in (30 cm)
Package 2 width	11.81 in (30 cm)
Package 2 Length	15.75 in (40 cm)

Offer Sustainability

California proposition 65	WARNING: This product can expose you to chemicals including: Nickel compounds, which is known to the State of California to cause cancer, and Di-isodecyl phthalate (DIDP), which is known to the State of California to cause birth defects or other reproductive harm. For more information go to www.P65Warnings.ca.gov
REACH Regulation	 REACH Declaration
REACH free of SVHC	Yes
EU RoHS Directive	Pro-active compliance (Product out of EU RoHS legal scope)  EU RoHS Declaration
Toxic heavy metal free	Yes
Mercury free	Yes
RoHS exemption information	 Yes
China RoHS Regulation	 China RoHS Declaration
WEEE	The product must be disposed on European Union markets following specific waste collection and never end up in rubbish bins.

Contractual warranty

Warranty	18 months
----------	-----------

Dimensions

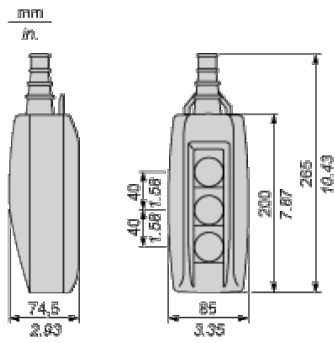

Protective cable sleeves

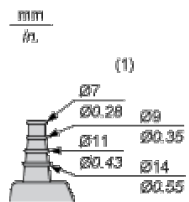

(1) Internal \varnothing

Control of Single-Speed Reversing Motor 2-Phase Switching

With XESD1191 contact block, to be ordered separately

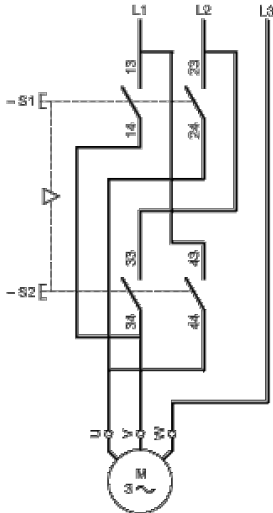

Combined with 3-pole isolating block XACS399 or XACS3991, shown in the unoperated position (pendant station "supplied"), fitted with key release trigger action latching Emergency stop operator.

